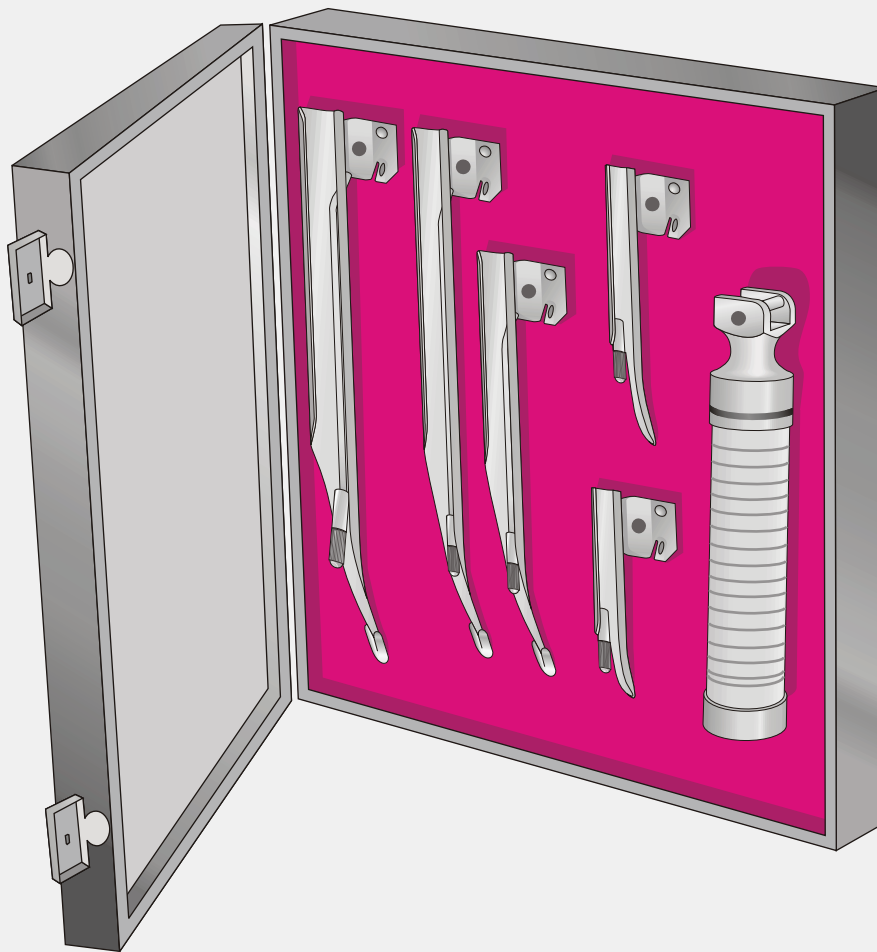




SAFE TOOL
MANUFACTURER & EXPORTER



Diagnostic & Anaesthesia Instruments



www.safetool.com.pk

***Surgical
Instruments***

PROFILE

Safe Tool Instruments is highly experienced Manufacturer & exporter of high quality **Surgical Instruments** and also in the field of **Orthopaedic, Arthroscopy, Gynaecology, Bone Surgery, E.N.T Instruments** since 2007.

We represent latest and directives technologies and incorporate an up to date know how of modern techniques, combined with our most efficient customer support and service back up.

Our company is in pursuit of attaining excellence in our field through our dedicated research and development project and by incorporating latest technological advancements and inputs, available to us through different quarters of international scientific community.

We are committed to provide international quality Instruments at reasonable prices, complimented by our efficient and versatile customer support system, so as to achieve complete customer satisfaction through business ethics.

We manufacture only premium quality Instruments of Medical Field. We can even customize an entire line of products to meet your needs as a distributor.

Private labeling is also available to qualified accounts!

We use only the finest materials and most advanced processes to manufacturer **our high Quality Instruments**

Mission Statement:

SAFE TOOL Mission Continuous Enhancement economic well being of stakeholders through business in health Solutions, medical devices and Instruments. The Customers are the most important stakeholders in **Safe Tool Instruments**

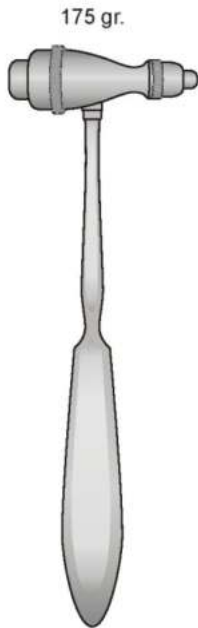
Safe Tool Instruments believe in working close with its customers to understand and fulfill their intended as well as unintended needs. Call us or email on info@safetool.com.pk for any further assistance our staff is always ready to serve the best to our esteemed customers.



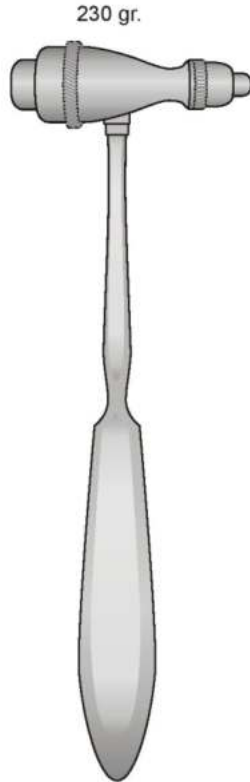
SAFE TOOL INSTRUMENTS

Sialkot-51310 Pakistan
Cell: +92-334-6100200
Email: info@safetool.com.pk
Web: www.safetool.com.pk

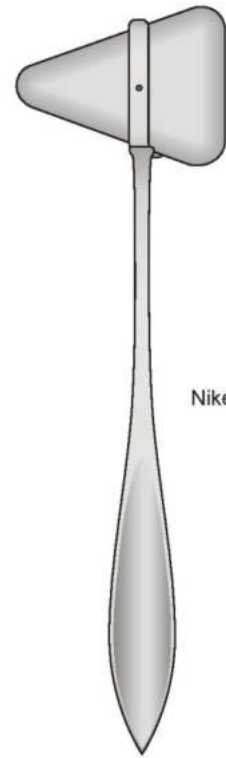




TROEMNER
ST-12001
140 mm

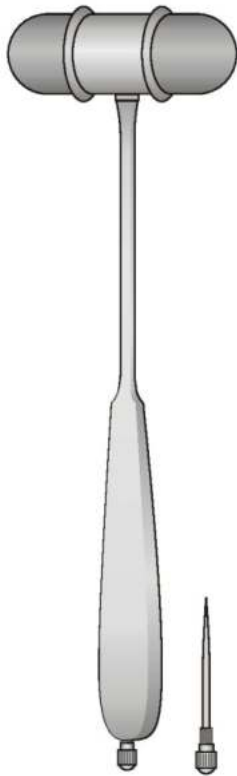


TROEMNER
ST-12002
240 mm

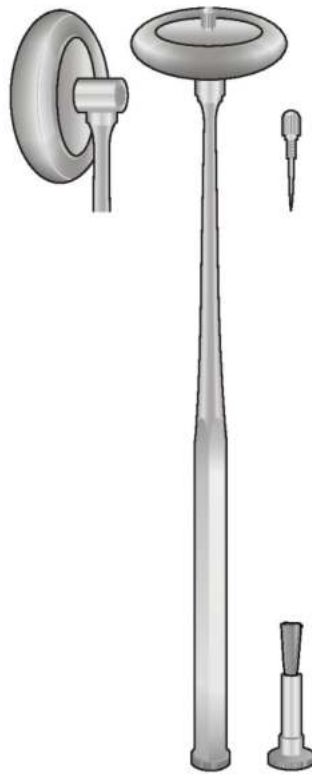


TAYLOR
ST-12003
200mm

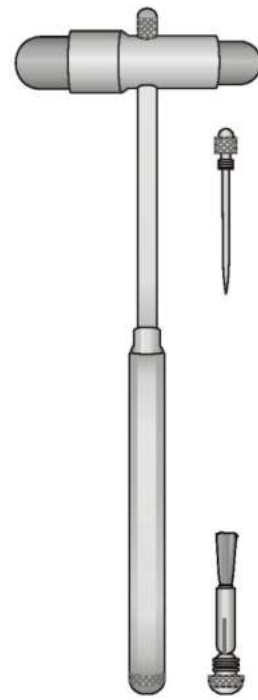
Con ago - With pin
Mit nadel - Avec aiguille
Con aguja



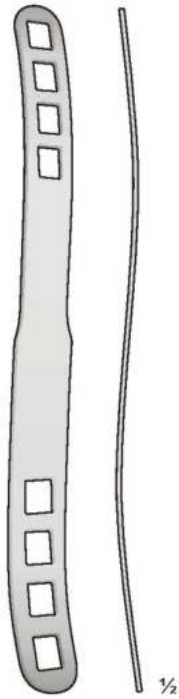
DEJERINE
ST-12004
200mm



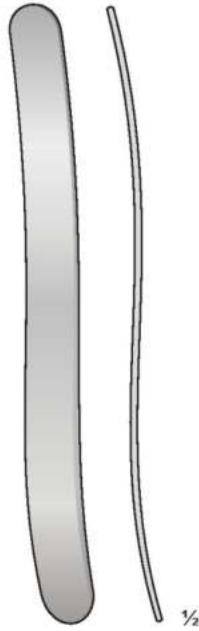
BABINSKY
ST-12005
255mm



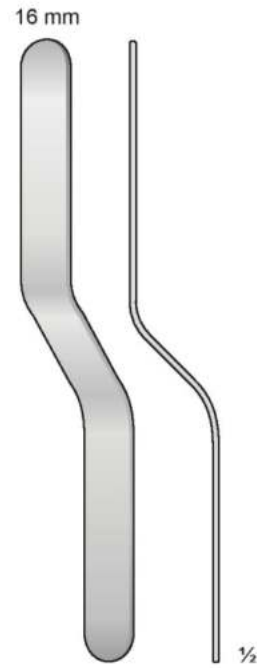
BUCK
ST-12006
180mm



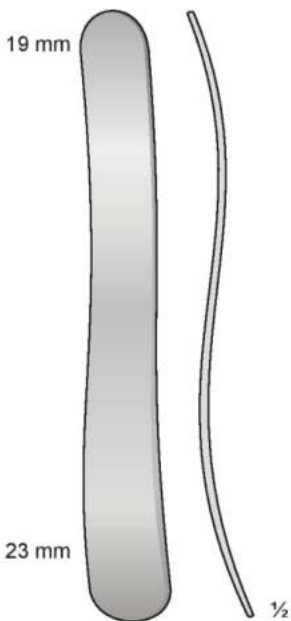
BRUENINGS
ST-12007
190 mm



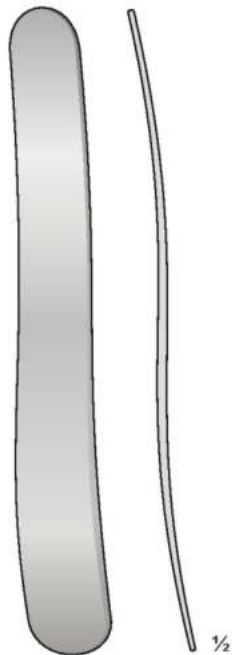
ST-12008
145 mm



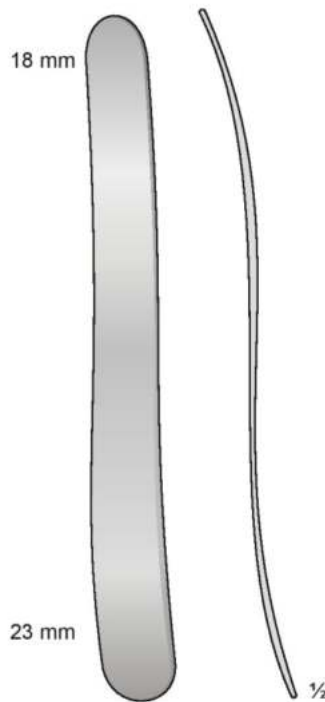
ST-12009
45 mm



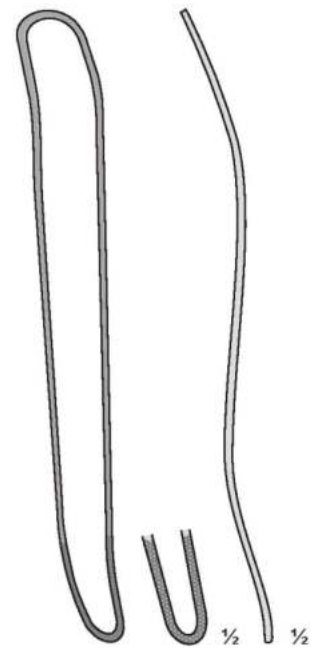
KROENIG
ST-12010
150 mm



MAYO
ST-12011
170 mm



BUCHWALD
ST-12012
180 mm



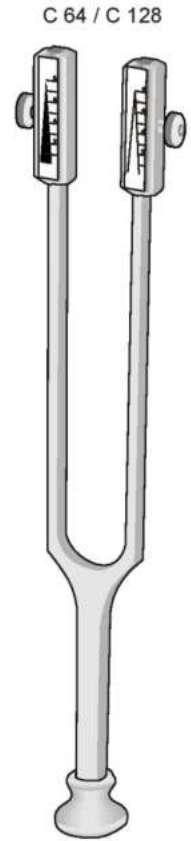
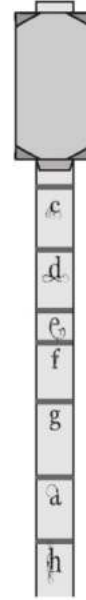
FRENZEL
ST-12013
165 mm



ST-12014

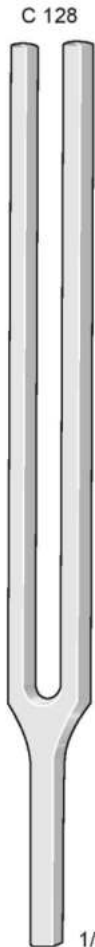


LUCAE
ST-12015

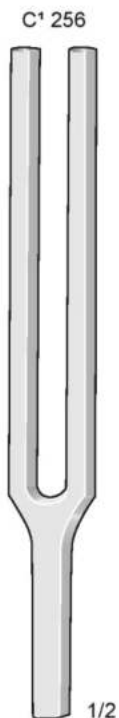


RYDEL-SEIFER
ST-12016

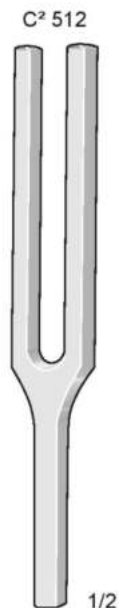
C 64
Con smorzatore - With clamps
Mit Dämpfer - Avec curseurs
C 128
Senza smorzatore - Without clamps
Ohne Dämpfer - Sans curseurs



HARTMANN
ST-12017



HARTMANN
ST-12018



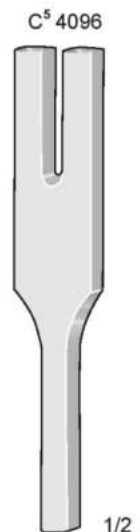
HARTMANN
ST-12019



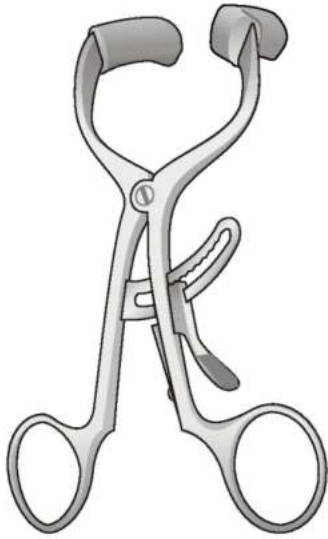
HARTMANN
ST-12020



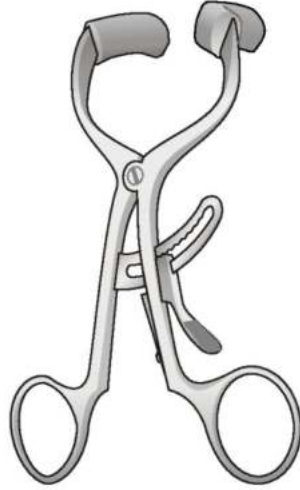
HARTMANN
ST-12021



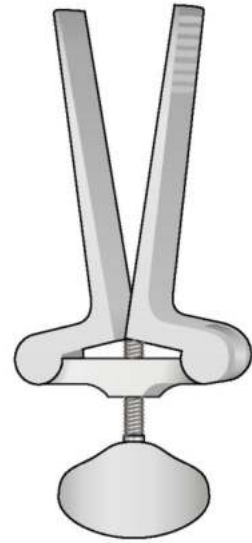
HARTMANN
ST-12022



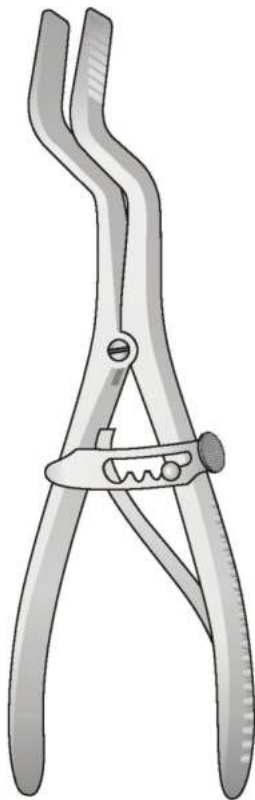
DOYEN-JANSEN
ST-12023
140 mm



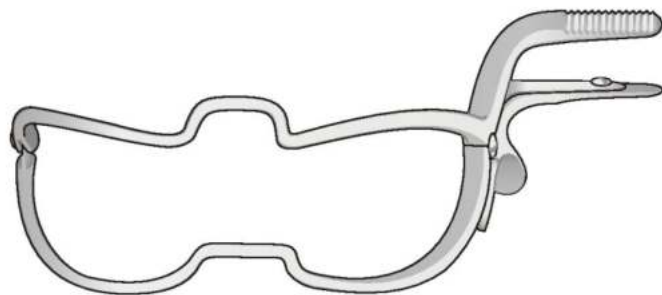
DOYEN-COLLIN
ST-12024
120 mm



HEISTER
ST-12025
135 mm



ROSER-KÖNIG
ST-12026
185 mm



WHITEHEAD-JENNINGS
ST-12027 90 mm
ST-12027-1 110 mm
ST-12027-2 130 mm
ST-12027-3 150 mm

Anestesia - Anesthesia
Anaesthesie - Anesthésie - Anestesia



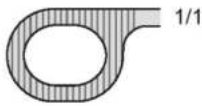
ST-12028-1
150 mm



ST-12028-2
200 mm



ST-12028-3
250 mm

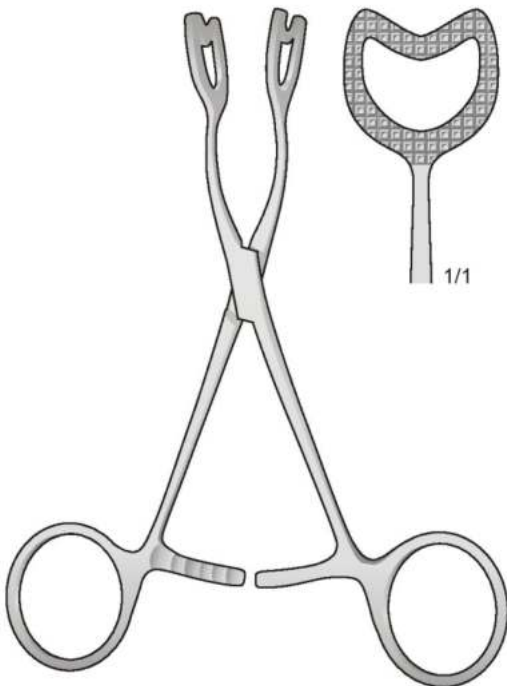


ST-12028-4
250 mm

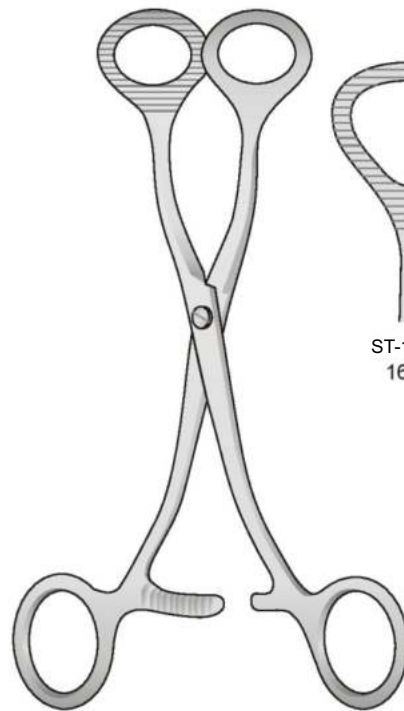


Pinze da intubazione
Kathetereinführungszangen
Catheter introducing forceps
Pinces à intubation
Pinzas para introducir catéteres

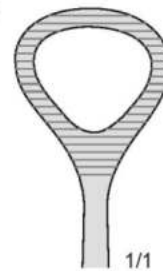
MAGILL
ST-12028



ST-12029
140 mm



COLLIN
ST-12030



ST-12030-1
165 mm

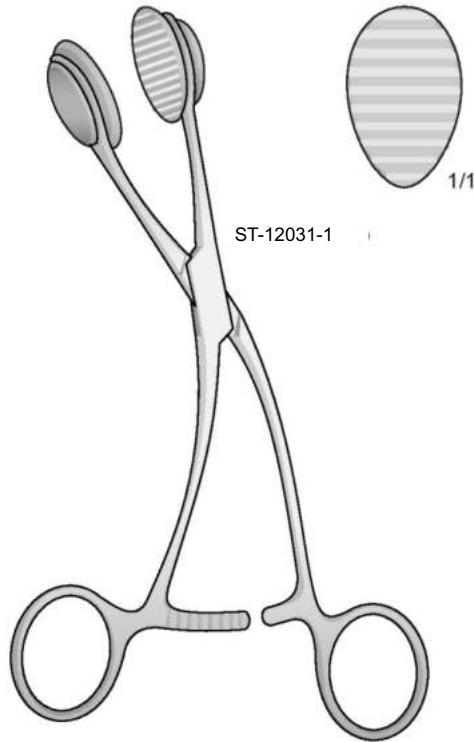


ST-12030-2
170 mm



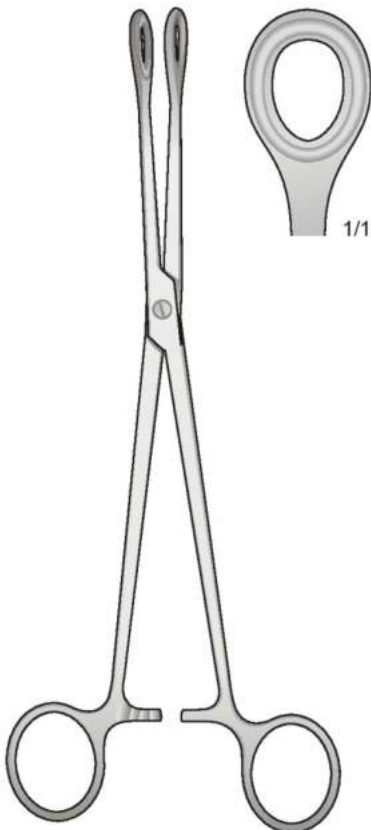
Tongue Forceps

Gommini di ricambio 2 pezzi
1 Pair of rubber pads
1 Paar ersatzgummi
1 Paire de mors caoutchouc
1 Paar placas de caucho



ST-12031-1

Pinza per batuffoli e tamponi
Cotton swab-Sponge holding forceps
Tupfer-Schwammzangen
Pincas à tampons et è ponges
Pinzas para tampones porta esponjas



ST-12032
230 mm

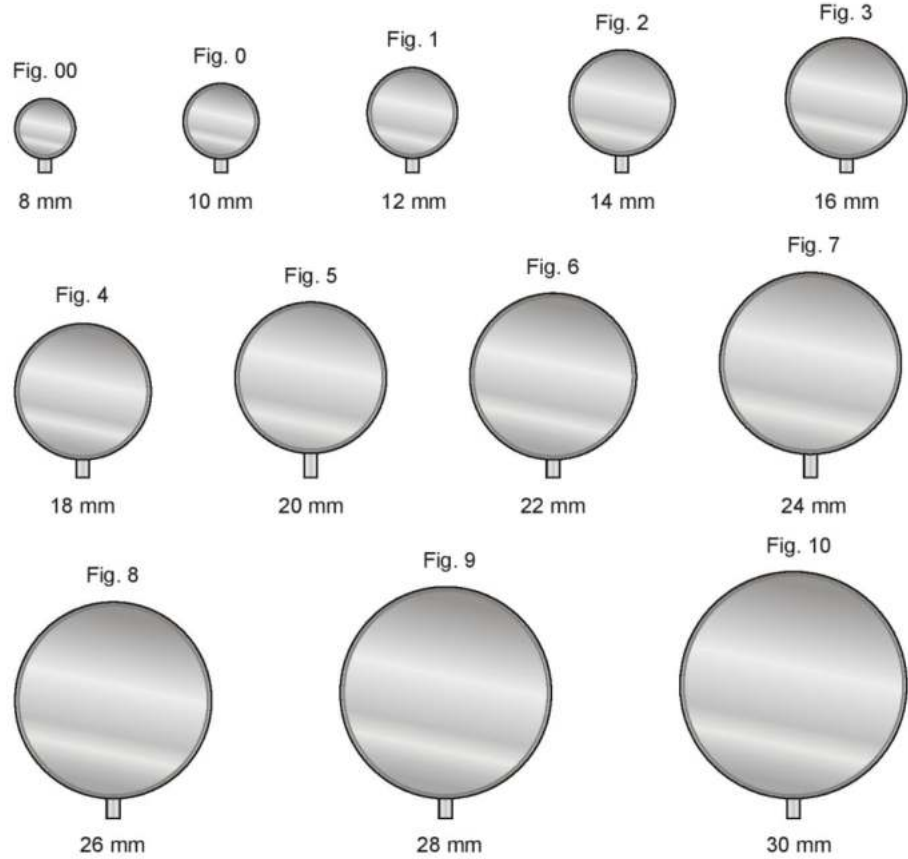
YOUNG
ST-12031
160 mm

Gommini di ricambio 2 pezzi
1 Pair of rubber pads
1 Paar ersatzgummi
1 Paire de mors caoutchouc
1 Paar placas de caucho



ST-12033-1

CHILD
ST-12033
240 mm



Specchietto laringeo
con manico esagonale
Laryngeal mirrors
with hexagonal handle
Miroirs laryngiens
avec manche hexagonal

Inox



ST-12034
180 mm

Diametro dello specchio - Diameter of mirrors - Spiegeldurchmesser
Diamètre des miroirs - Diámetro de los espejos

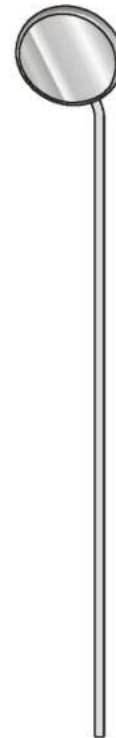
Manico per specchietti
Mirrors handle
Spiegelgriff
Manche à miroir
Manico para espejos

Nikel-Chrom



ST-12035
120 mm

Specchietto laringeo
Laryngeal mirrors
Kehlkopfspiegel
Miroirs laryngiens
Espejos laringeos



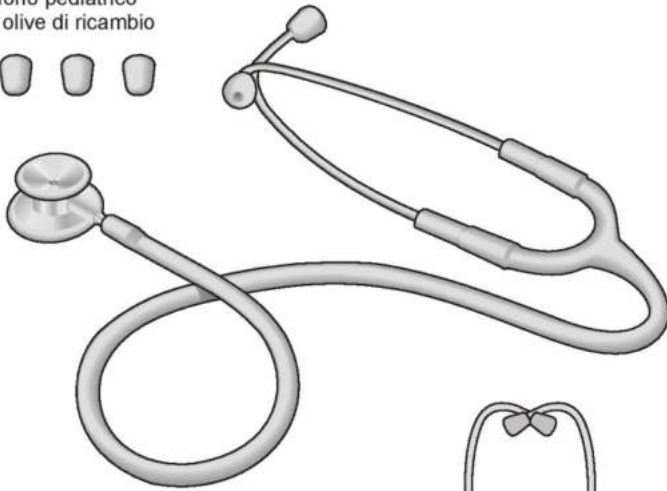
ST-12036
120 mm

	Fig.
01-370-08	00
01-370-10	0
01-370-12	1
01-370-14	2
01-370-16	3
01-370-18	4
01-370-20	5
01-370-22	6
01-370-24	7
01-370-26	8
01-370-28	9
01-370-30	10

	Fig.
01-390-08	00
01-390-10	0
01-390-12	1
01-390-14	2
01-390-16	3
01-390-18	4
01-390-20	5
01-390-22	6



Duofono pediatrico
Con 4 olive di ricambio



ST-12037

In legno
Of wood
Aus Holz
En bois
De madera



ST-12038
145 mm



LEVIS - CLASSIC
ST-12039

Professional
Con 4 olive di ricambio



ST-12040

Fonendoscopio
Classic



ST-12041



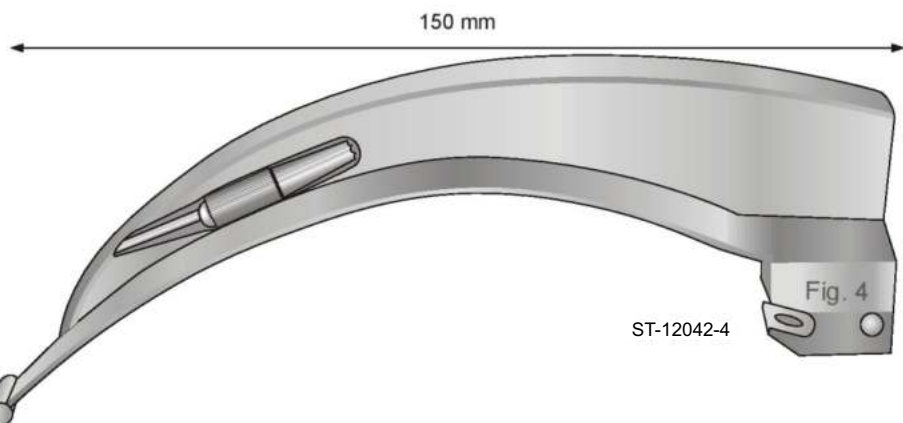
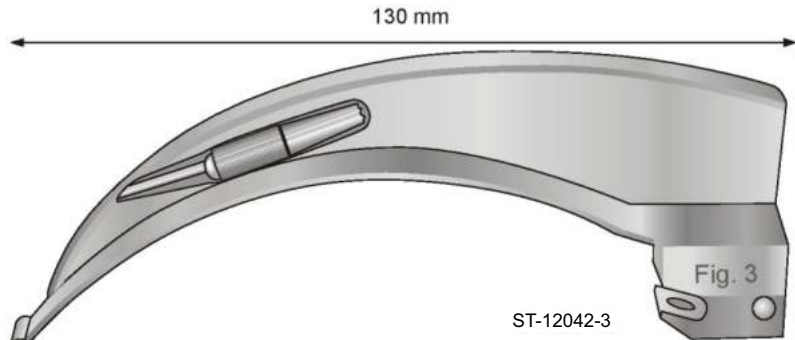
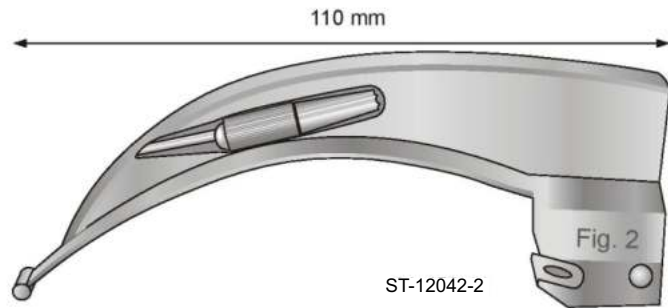
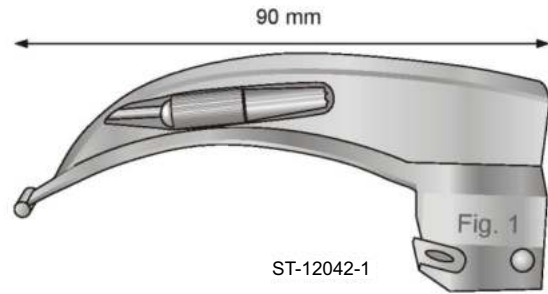
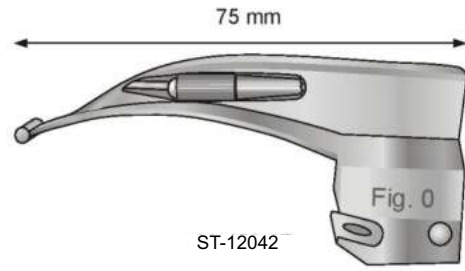
Laringoscopio
MC INTOSH



AA-B100
2,5 Volt
300 mA
Per lama **AA-100**
For blades **AA-100**
Für Spatel **AA-100**
Pour spatules **AA-100**
Para hojas **AA-100**



AA-B101
2,5 Volt
300 mA
Per lame **AA-101 + AA-104**
For blades **AA-101 + AA-104**
Für Spatel **AA-101 + AA-104**
Pour spatules **AA-101 + AA-104**
Para hojas **AA-101 + AA-104**





Laringoscopio
MILLER



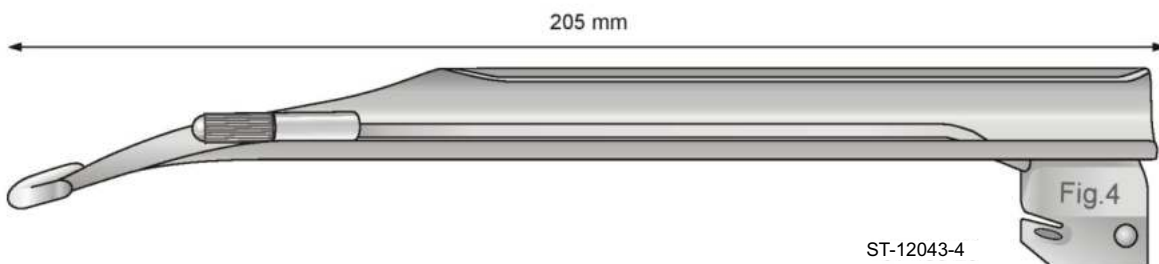
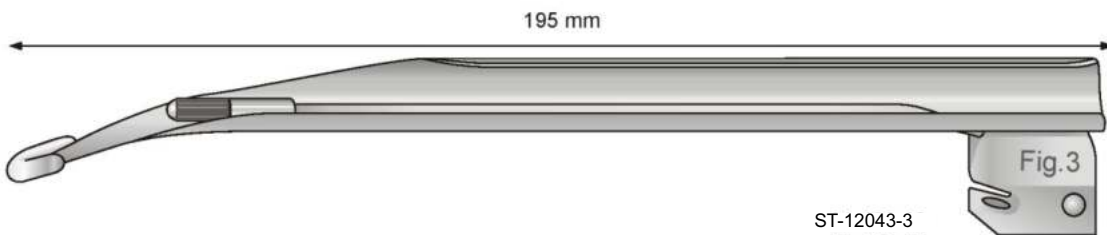
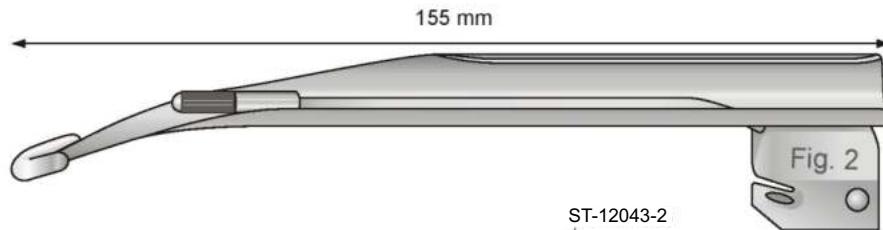
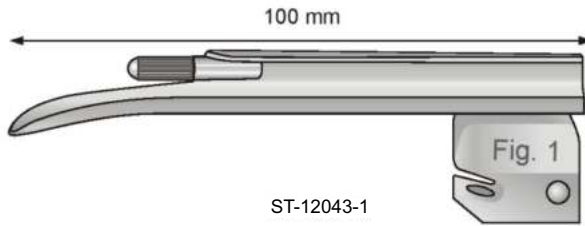
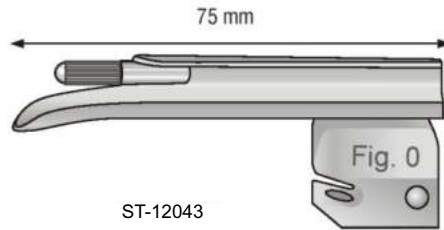
AA-B100
2,5 Volt
300 mA

Per lama **AA-200 + AA-203**
For blades **AA-200 + AA-203**
Für Spatel **AA-200 + AA-203**
Pour spatules **AA-200 + AA-203**
Para hojas **AA-200 + AA-203**



AA-B101
2,5 Volt
300 mA

Per lama **AA-204**
For blades **AA-204**
Für Spatel **AA-204**
Pour spatules **AA-204**
Para hojas **AA-204**



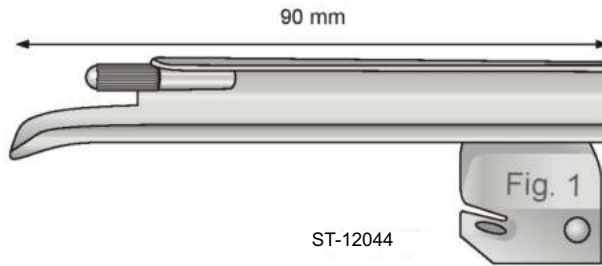


Laringoscopio
NEGUS - GUEDEL



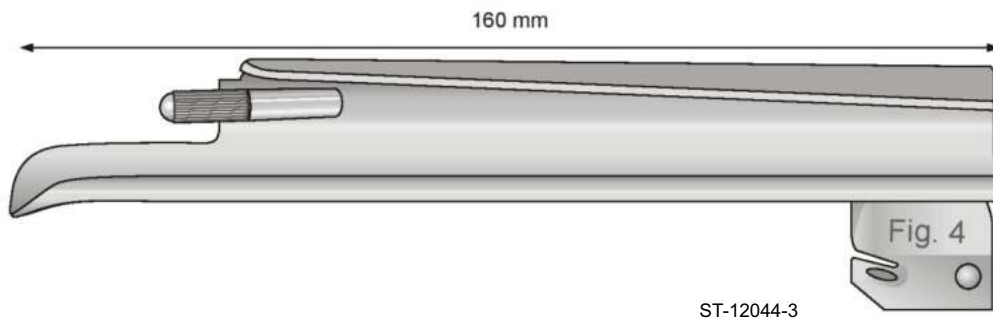
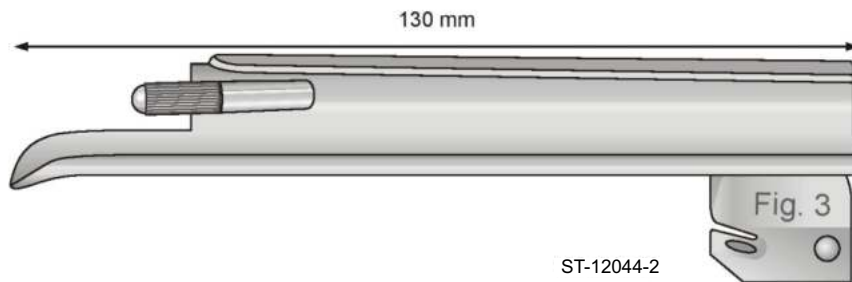
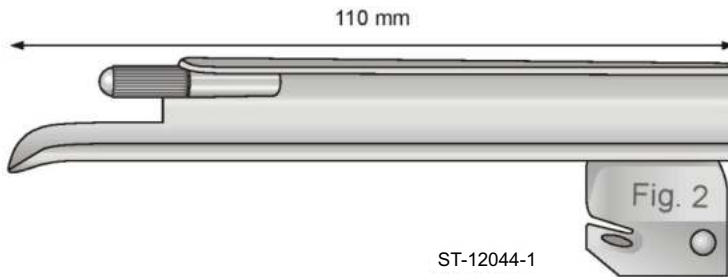
AA-B100
2,5 Volt
300 mA

Per lama **AA-401**
For blades **AA-401**
Für Spatel **AA-401**
Pour spatules **AA-401**
Para hojas **AA-401**



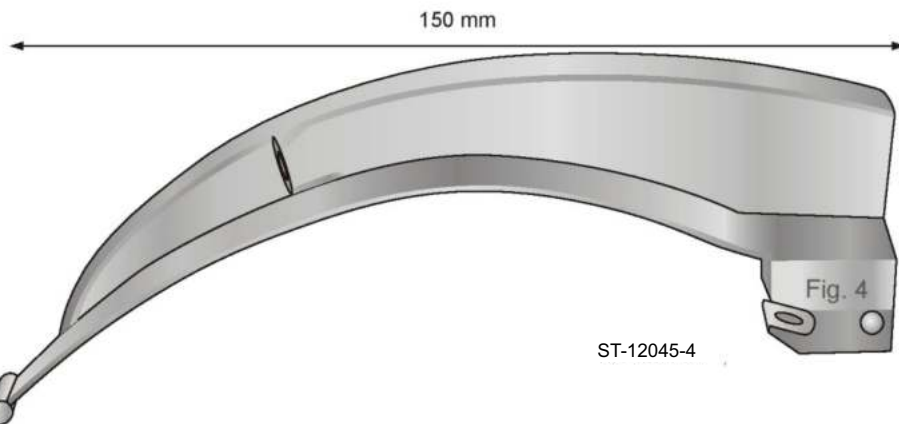
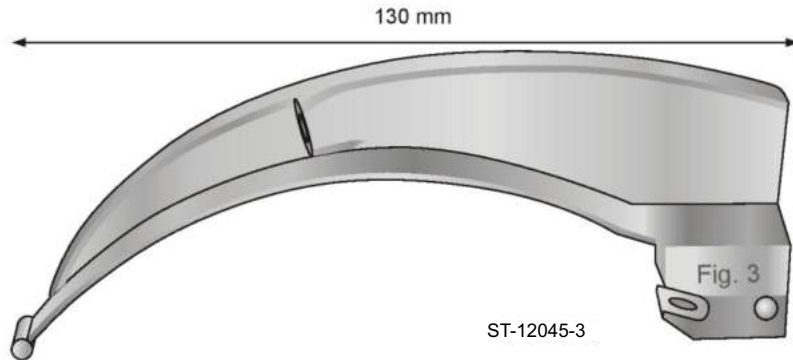
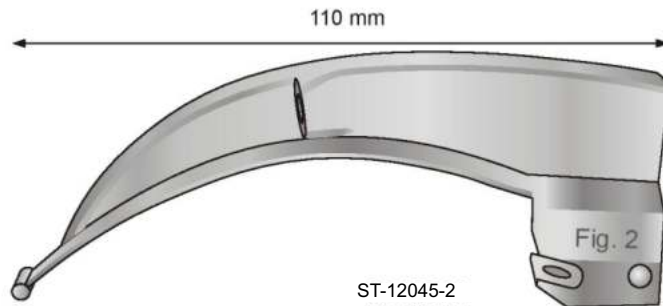
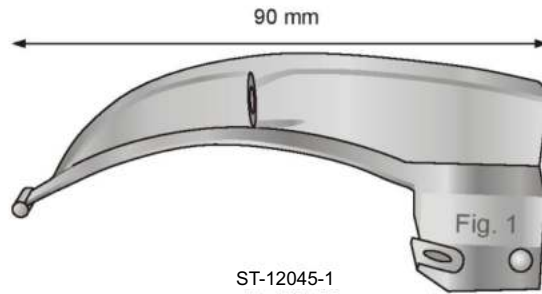
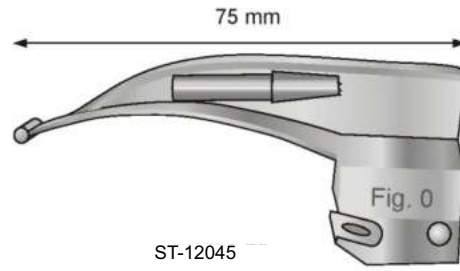
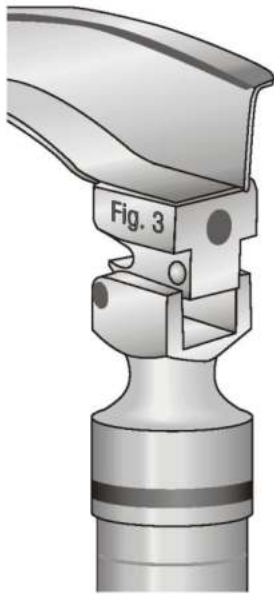
AA-B101
2,5 Volt
300 mA

Per lame **AA-402 + AA-404**
For blades **AA-402 + AA-404**
Für Spatel **AA-402 + AA-404**
Pour spatules **AA-402 + AA-404**
Para hojas **AA-402 + AA-404**



Laringoscopio
MC INTOSH

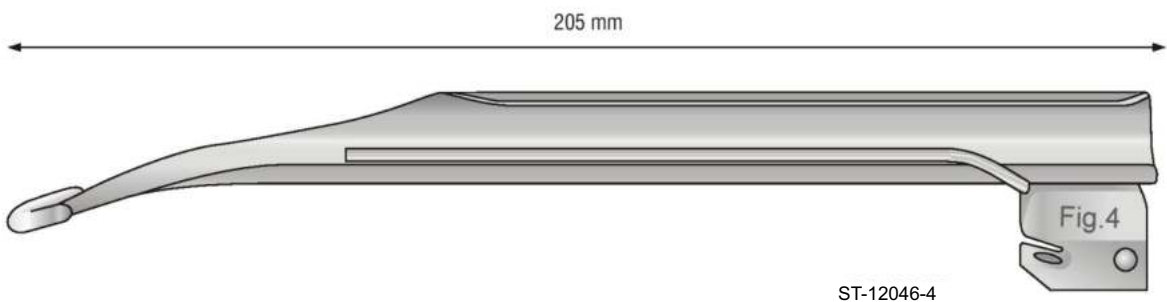
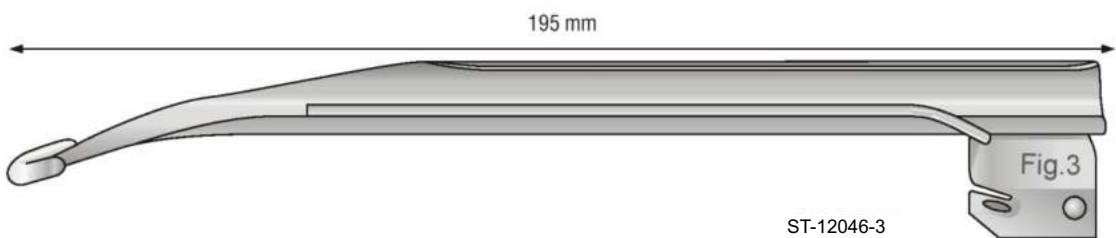
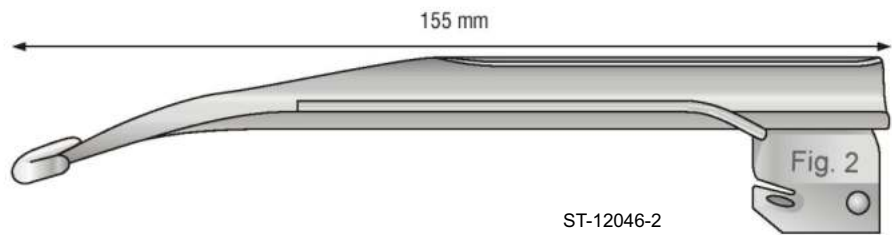
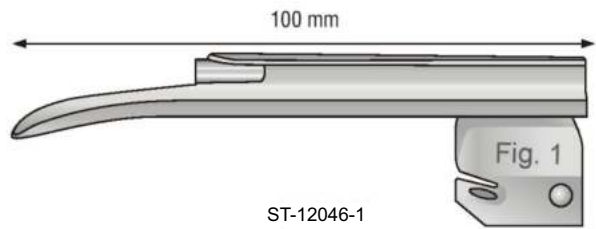
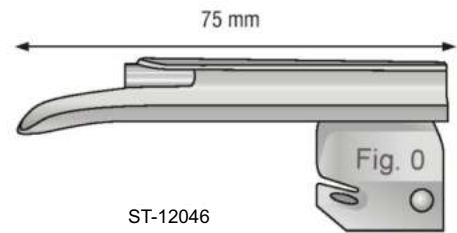
Fibre ottiche
Fiberoptic





Laringoscopio
MILLER

Fibre ottiche
Fiberoptic





- Mc INTOSH**
 ST-12047-1 - Set 3 lame
 ST-12047-2 - Set 4 lame
 ST-12047-3 - Set 5 lame



Fibre ottiche
Fiber optic

MILLER
01-530

- MILLER**
 ST-12048-1 - Set 3 lame
 ST-12048-2 - Set 4 lame
 ST-12048-3 - Set 5 lame

- NEGUS-GUEDEL**
 ST-12049-1 - Set 3 lame
 ST-12049-2 - Set 4 lame

- MILLER**
Fibre ottiche
 ST-12050-1 - Set 3 lame
 ST-12050-2 - Set 4 lame
 ST-12050-3 - Set 5 lame



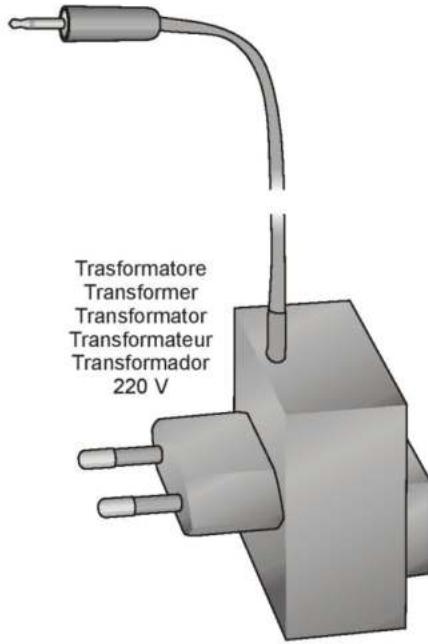
Fibre ottiche
Fiber optic

McINTOSH
01-540

- Mc INTOSH**
Fibre ottiche
 ST-12051-1 - Set 3 lame
 ST-12051-2 - Set 4 lame
 ST-12051-3 - Set 5 lame

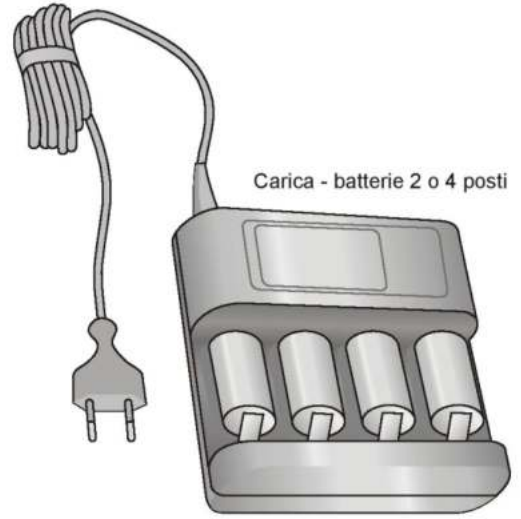


ST-12052-1
Ø 30 mm



Trasformatore
Transformer
Transformator
Transformateur
Transformador
220 V

ST-12053-1



Carica - batterie 2 o 4 posti

ST-12054-1



ST-12055-1
640 mA



ST-12055-2
2,5Volt
300 mA



ST-12055-3
2,5Volt
300 mA

Lampade alogene - Halogen lamp
Halogenlampe - Lampe halogène - Lämpara Houlógeno



ST-12056
Ø 30 mm

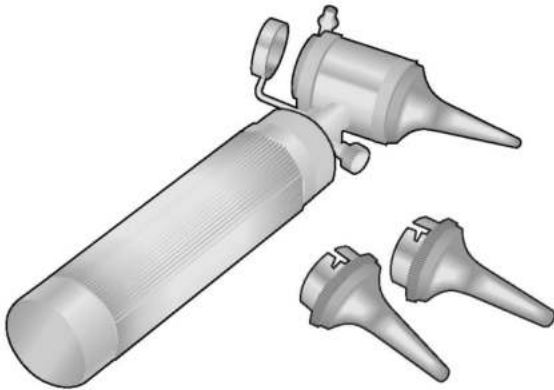


ST-12057
Ø 18 mm

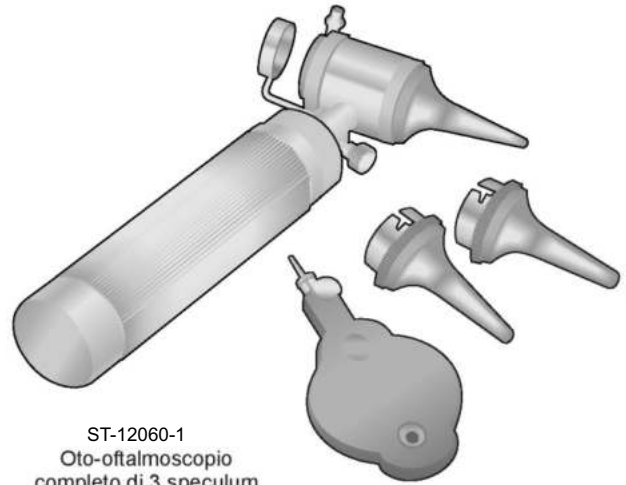
Fibre ottiche
Fiber optic



ST-12058
Ø 30 mm



ST-12059-1
Otoscopio
completo di 3 speculum
e scatola



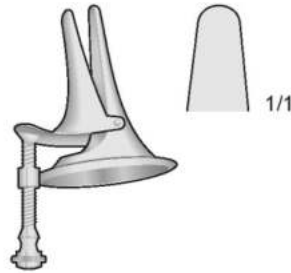
ST-12060-1
Oto-oftalmoscopia
completo di 3 speculum

Speculum in Nylon



- # 1 - Ø 3,0 mm
- # 2 - Ø 4,5 mm
- # 3 - Ø 5,5 mm

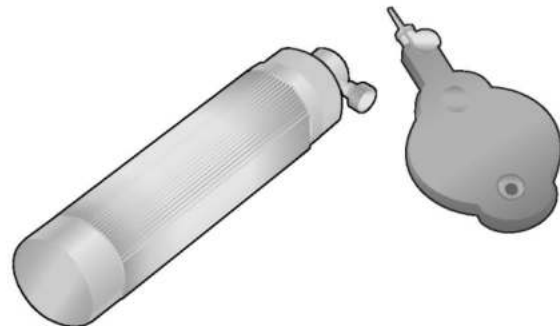
ST-12061-1
Serie 3 pezzi



DUPLAY
ST-12062-1

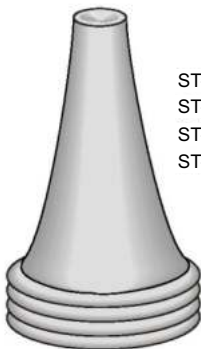


ST-12064-1
Lampadina per otoscopio
Lamp
Lampe



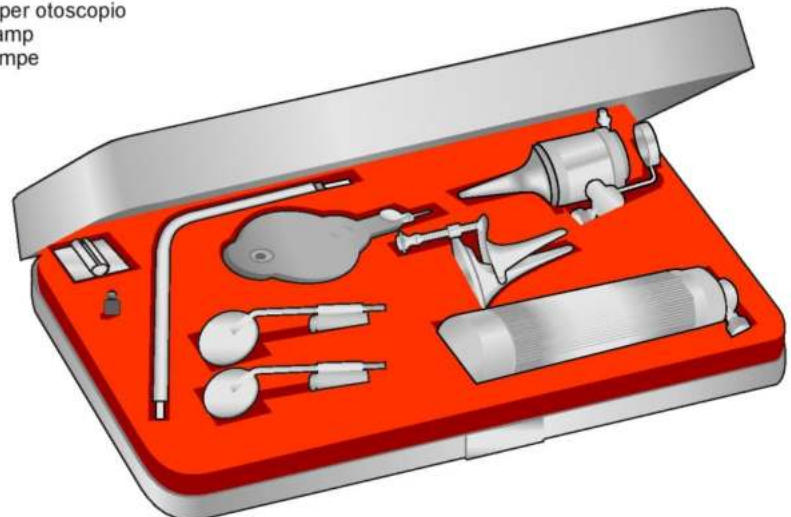
ST-12063-1
Oftalmoscopia

Speculum per adulti



- ST-12065-1 - Ø 4,5 mm
- ST-12065-2 - Ø 5,5 mm
- ST-12065-3 - Ø 6,5 mm
- ST-12065-4 - Ø 7,5 mm

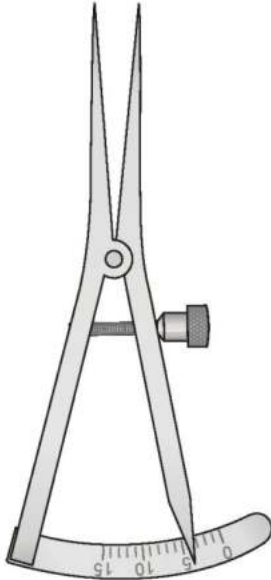
HARTMANN
ST-12065-1
Set 4 pezzi



ST-12066-1
Set ototo-oftalmoscopia-speculum nasale
e 2 specchietti laringei

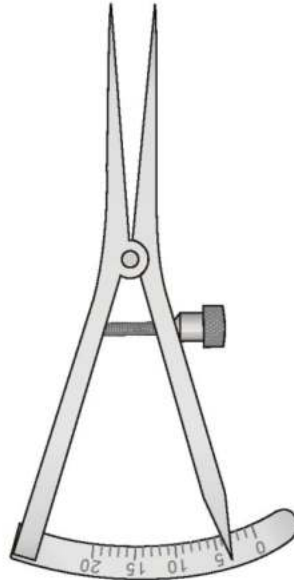


Campo di misura: 0 - 15 mm
Measuring range: 0 - 15 mm
Meßbereich: 0 - 15 mm
Etendue de mesure: 0 - 15 mm
Alcance de medición: 0 - 15 mm



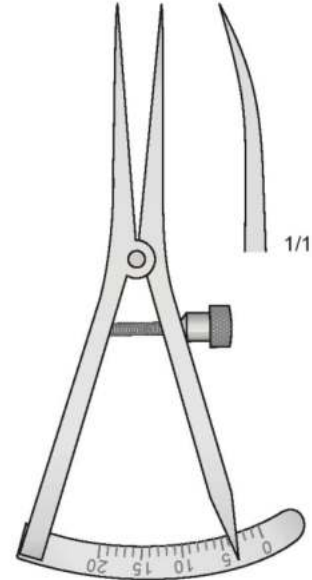
CASTROVIEJO
ST-12067-1
90 mm

Campo di misura: 0 - 20 mm
Measuring range: 0 - 20 mm
Meßbereich: 0 - 20 mm
Etendue de mesure: 0 - 20 mm
Alcance de medición: 0 - 20 mm



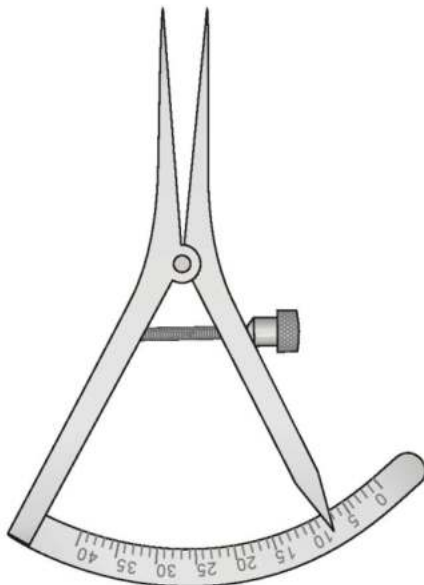
CASTROVIEJO
ST-12067-2
90 mm

Campo di misura: 0 - 20 mm
Measuring range: 0 - 20 mm
Meßbereich: 0 - 20 mm
Etendue de mesure: 0 - 20 mm
Alcance de medición: 0 - 20 mm



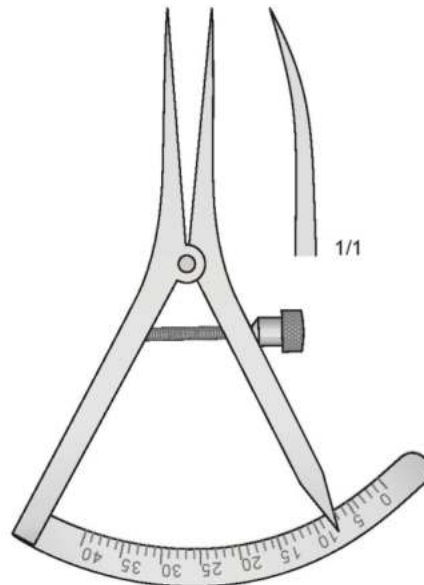
CASTROVIEJO
ST-12068-1
90 mm

Campo di misura: 0 - 40 mm
Measuring range: 0 - 40 mm
Meßbereich: 0 - 40 mm
Etendue de mesure: 0 - 40 mm
Alcance de medición: 0 - 40 mm



CASTROVIEJO
ST-12069-1
90 mm

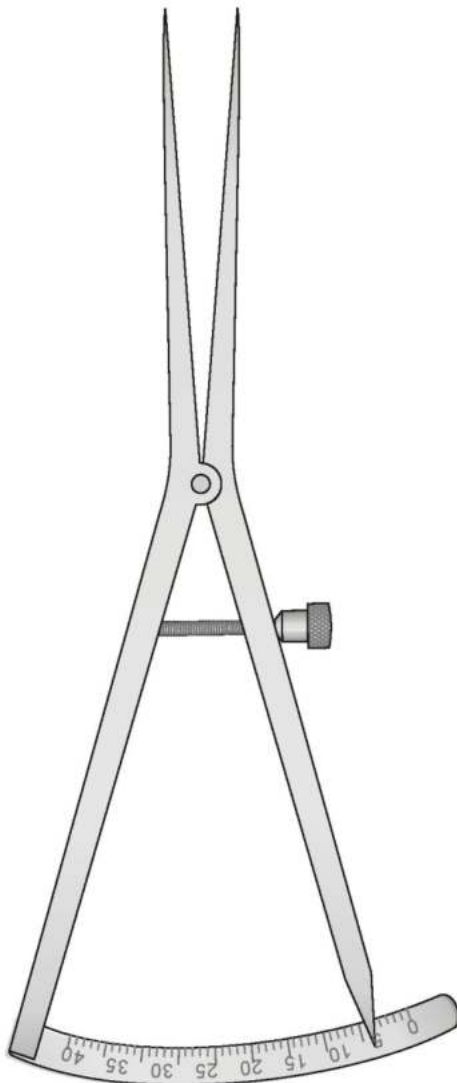
Campo di misura: 0 - 40 mm
Measuring range: 0 - 40 mm
Meßbereich: 0 - 40 mm
Etendue de mesure: 0 - 40 mm
Alcance de medición: 0 - 40 mm



CASTROVIEJO
ST-12070-1
90 mm

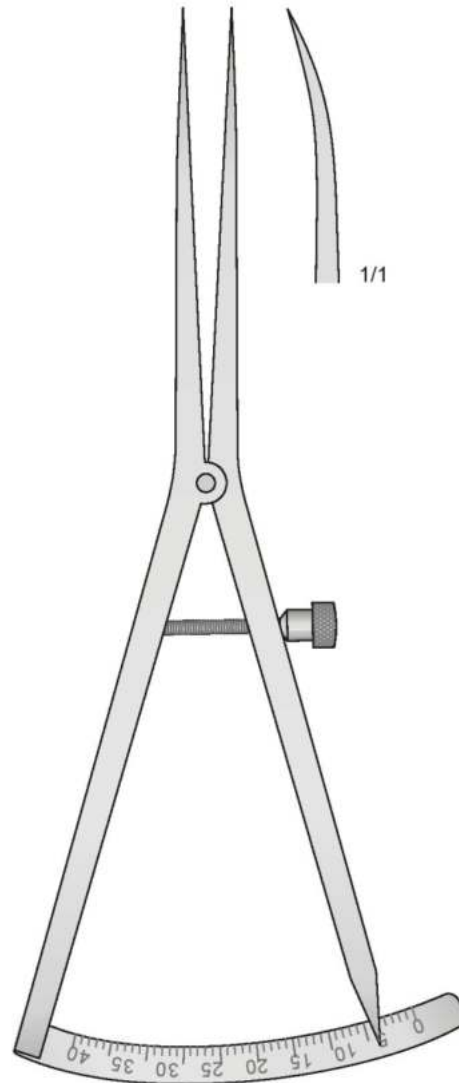


Campo di misura: 0 - 40 mm
Measuring range: 0 - 40 mm
Meßbereich: 0 - 40 mm
Etendue de mesure: 0 - 40 mm
Alcance de medición: 0 - 40 mm



CASTROVIEJO
ST-12071-1
170 mm

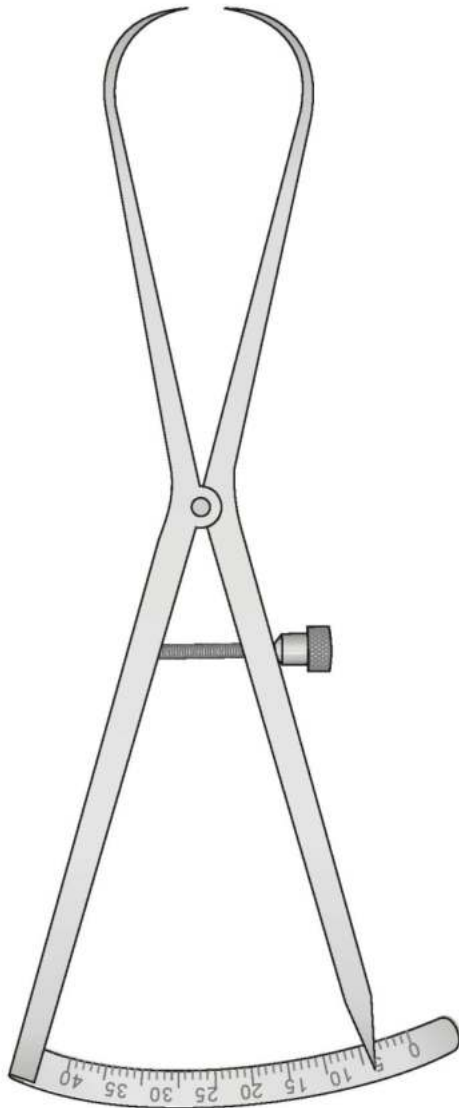
Campo di misura: 0 - 40 mm
Measuring range: 0 - 40 mm
Meßbereich: 0 - 40 mm
Etendue de mesure: 0 - 40 mm
Alcance de medición: 0 - 40 mm



CASTROVIEJO
ST-12072-1
170 mm

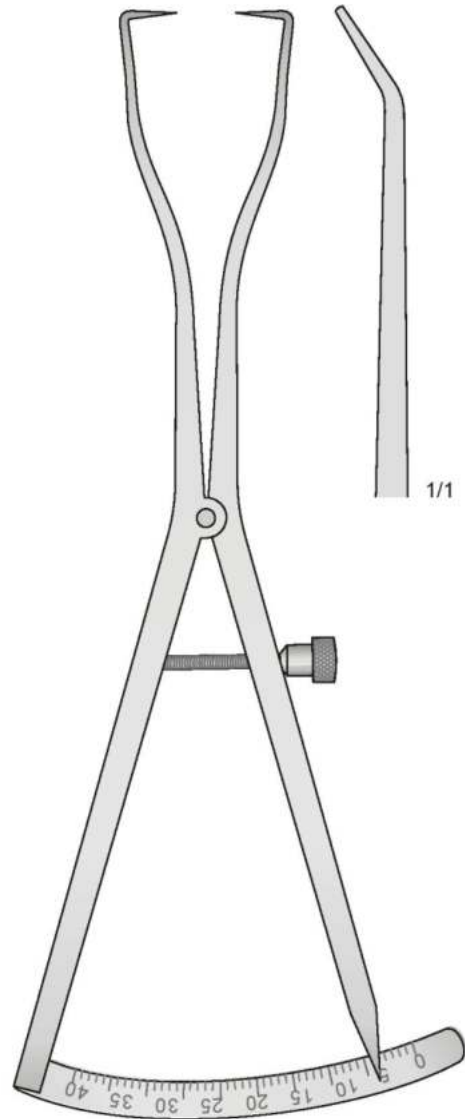


Campo di misura: 0 - 40 mm
Measuring range: 0 - 40 mm
Meßbereich: 0 - 40 mm
Etendue de mesure: 0 - 40 mm
Alcance de medición: 0 - 40 mm



CASTROVIEJO
ST-12073-1
170 mm

Campo di misura: 0 - 40 mm
Measuring range: 0 - 40 mm
Meßbereich: 0 - 40 mm
Etendue de mesure: 0 - 40 mm
Alcance de medición: 0 - 40 mm



CASTROVIEJO
ST-12074-1
170 mm

Campo di misura: 0 - 80 mm
Measuring range: 0 - 80 mm
Meßbereich: 0 - 80 mm
Etendue de mesure: 0 - 80 mm
Alcance de medición: 0 - 80 mm

Campo di misura: 0 - 80 mm
Measuring range: 0 - 80 mm
Meßbereich: 0 - 80 mm
Etendue de mesure: 0 - 80 mm
Alcance de medición: 0 - 80 mm

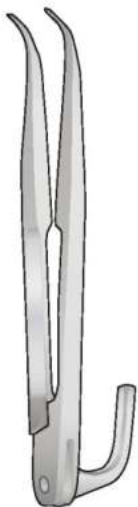


ST-12075
125 mm

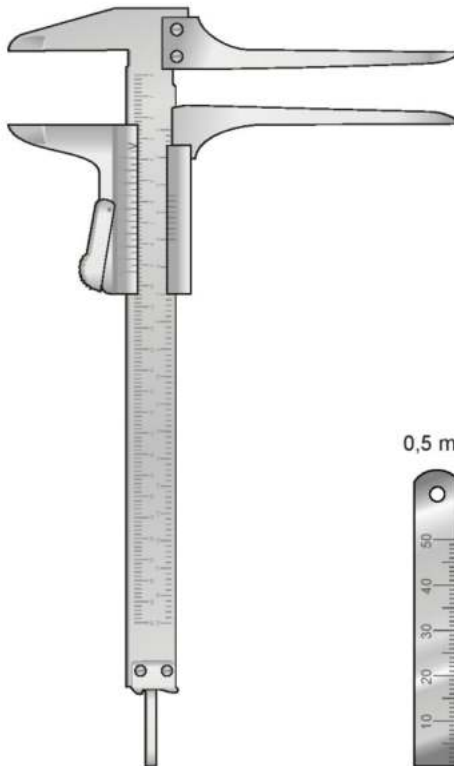


ST-12076
120 mm

Campo di misura: 180 mm - Measuring range: 180 mm
Meßbereich: 180 mm - Etendue de mesure: 180 mm - Alcance de medición: 180 mm



ZIELINSKY
ST-12077
110 mm



CASPAR
ST-12078



ST-12079
50 mm



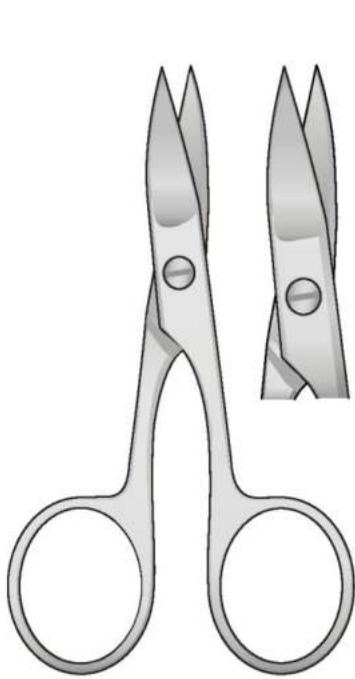
ST-12079-1
120 mm



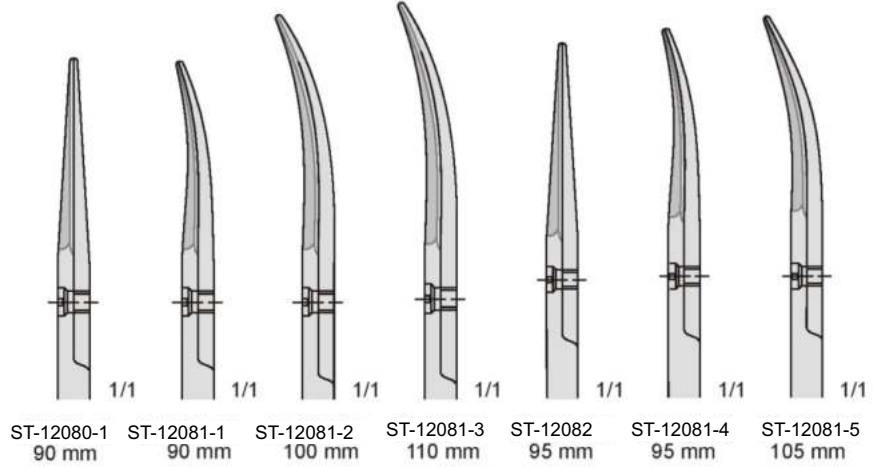
ST-12079-2
150 mm



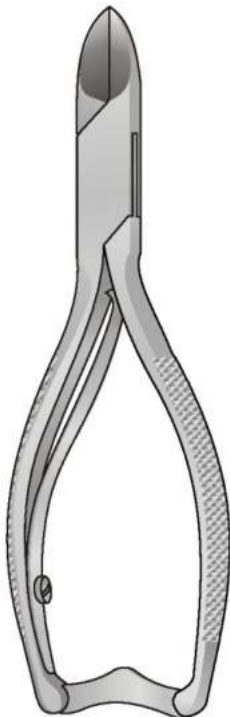
ST-12079-3
300 mm



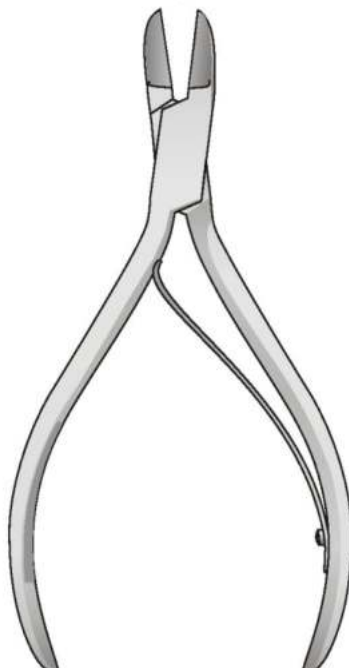
ST-12080



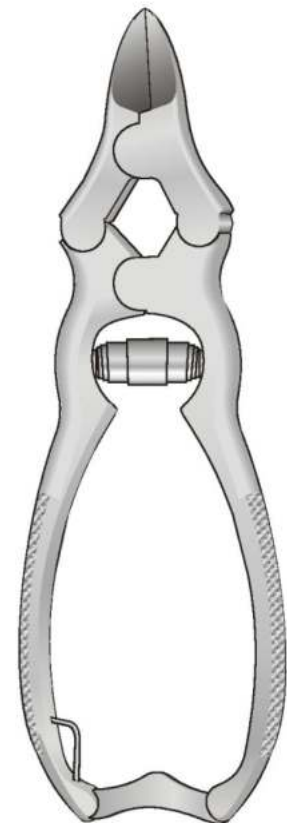
Tronchesi per unghie
Nail cutters
Nagelzangen
Pince à ongles
Pinzas para uña



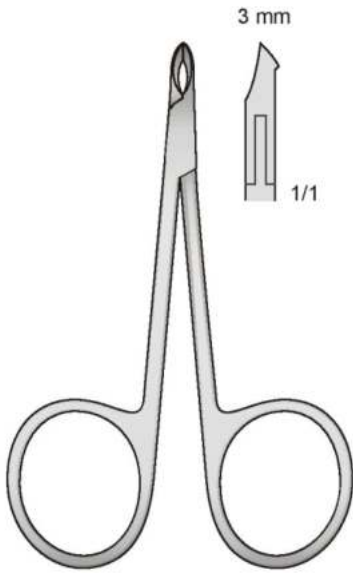
ST-12083
135 mm



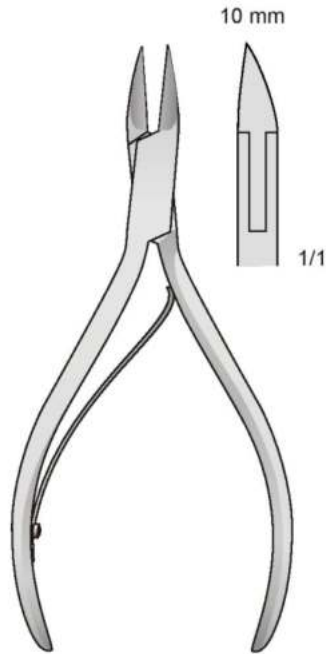
ST-12084
120 mm



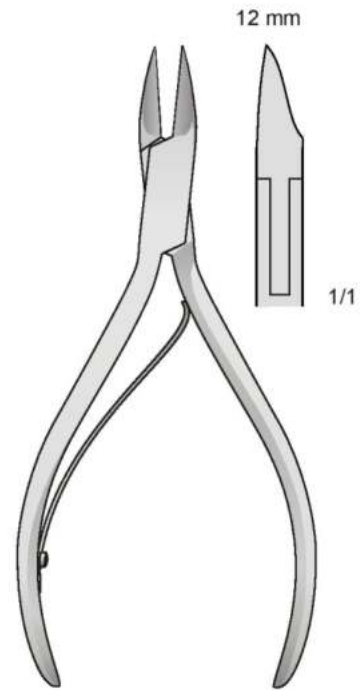
ST-12085
155 mm



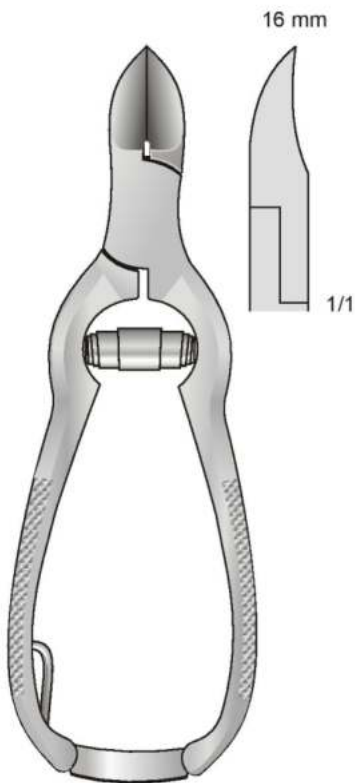
ST-12086
85 mm



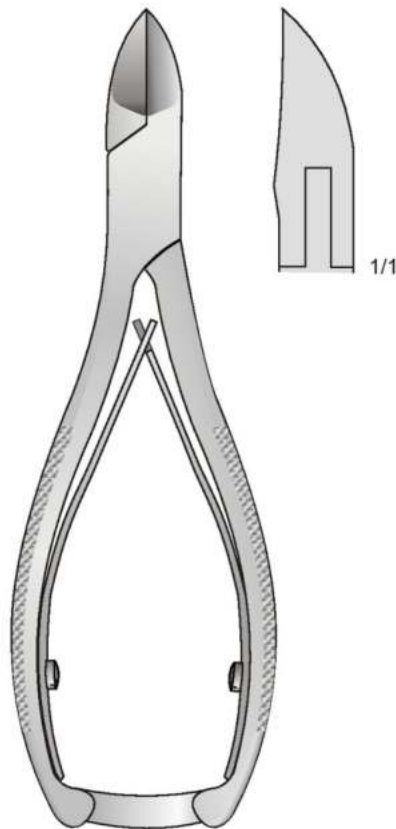
ST-12087-1
100 mm



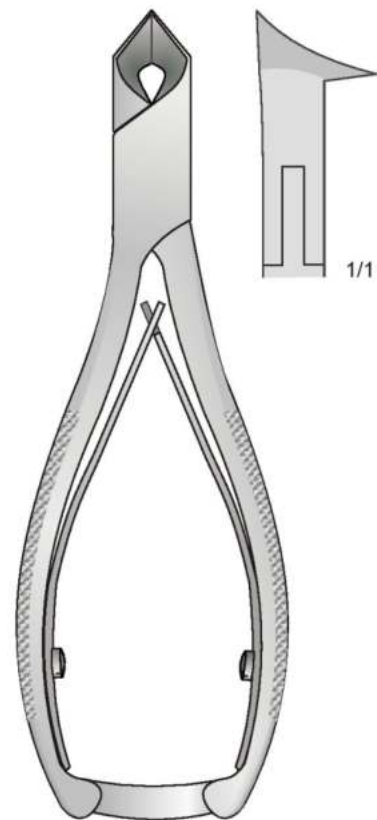
ST-12087-2
110 mm



ST-12088
120 mm



ST-12089
140 mm



ST-12090
135 mm



SAFE TOOL
MANUFACTURER & EXPORTER

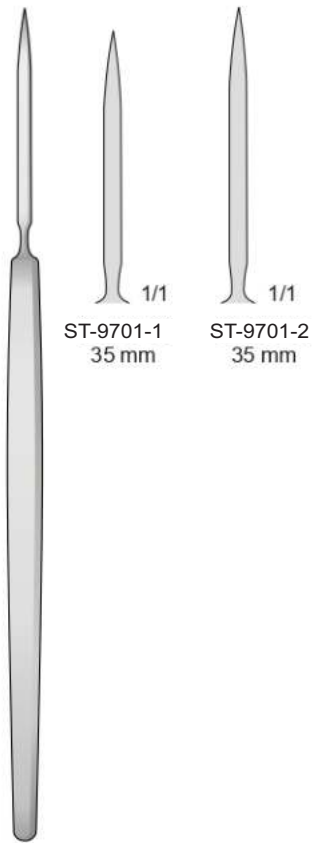


***Scalpel Blades
& Handles
instruments***

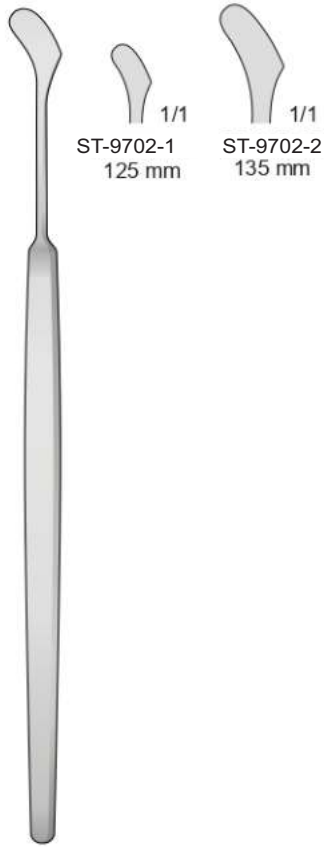


www.safetool.com.pk

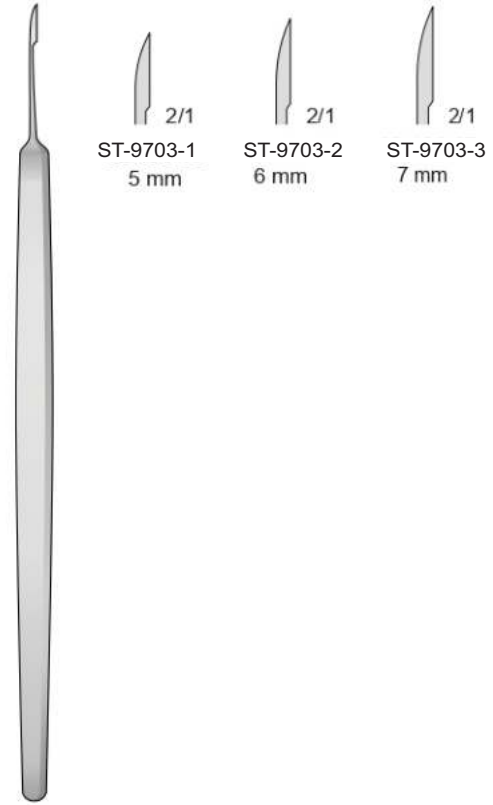
***SURGICAL
INSTRUMENTS***



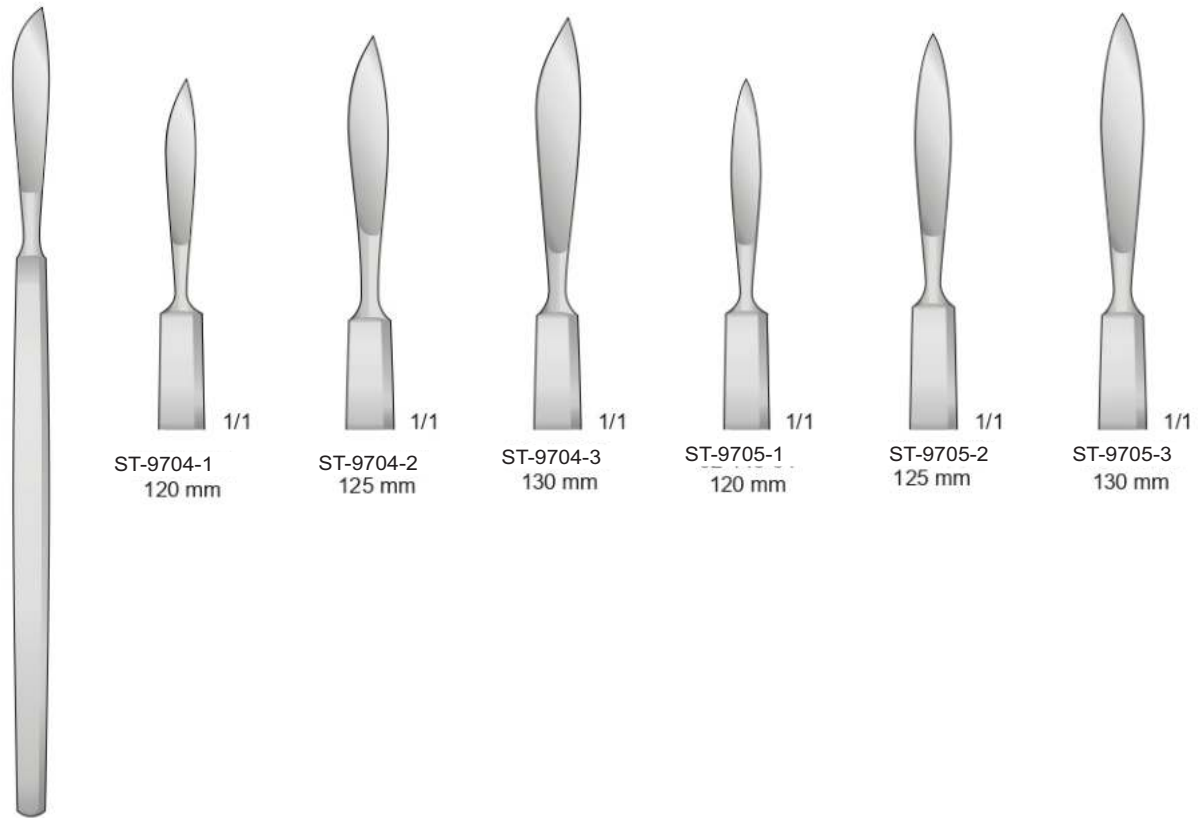
GRAEFE
ST-9701
140 mm



GRAEFE
ST-9702



ZIEGLER
ST-9703
115 mm



ST-9704



Punche da biopsia - Dermal punches
Haut-Trephinen - Tréphines cutanées
Trépanos cutâneos



- 3 mm
ST-9709-1
- 4 mm
ST-9709-2
- 5 mm
ST-9709-3
- 6 mm
ST-9709-4



DESMARRES
ST-9709
135 mm



DESMARRES
ST-9710
135 mm



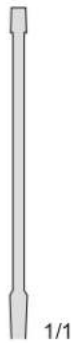
ST-9706
180 mm



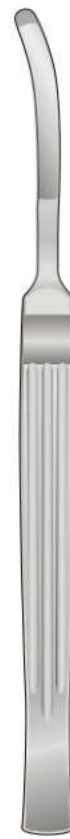
ST-9707
280 mm



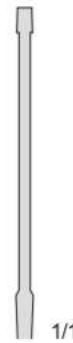
JOSEPH
ST-9711
150 mm



1/1



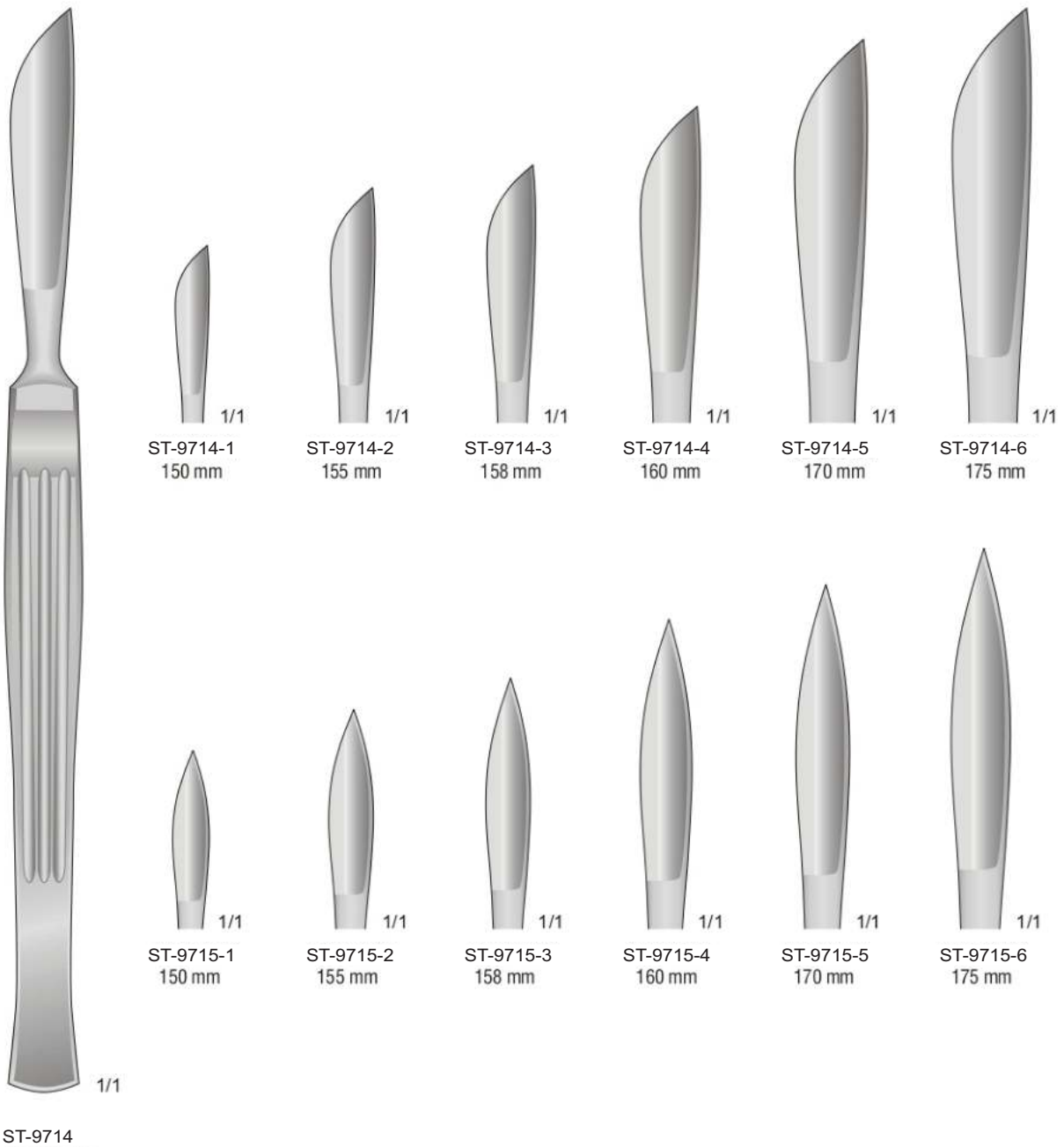
CONVERSE
ST-9712
160 mm

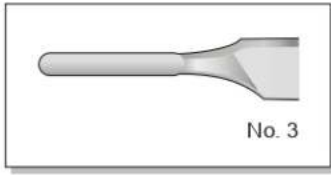


1/1



ST-9713
160 mm





ST-9716
Fig. 3



ST-9717
Fig. 3M



ST-9718
Fig. 7



ST-9719
Fig. 7k



ST-9720
Fig. 5



ST-9721
Fig. 5a

1,5 mm



02-310-15
B

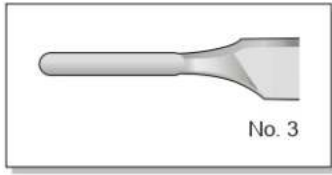
2,5 mm



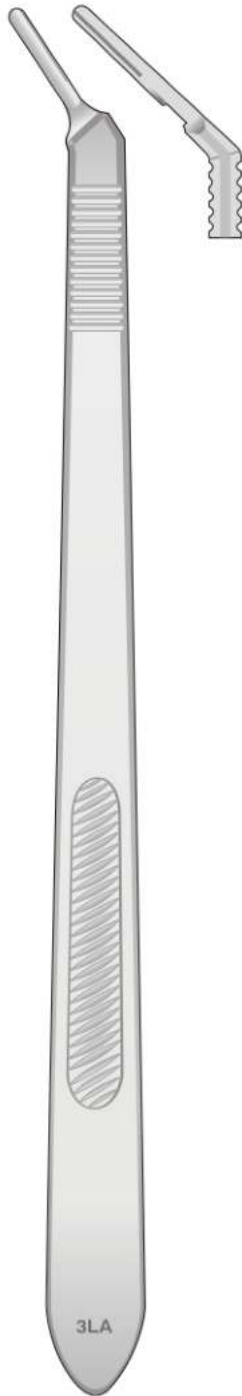
02-310-15
C



ST-9722
155 mm



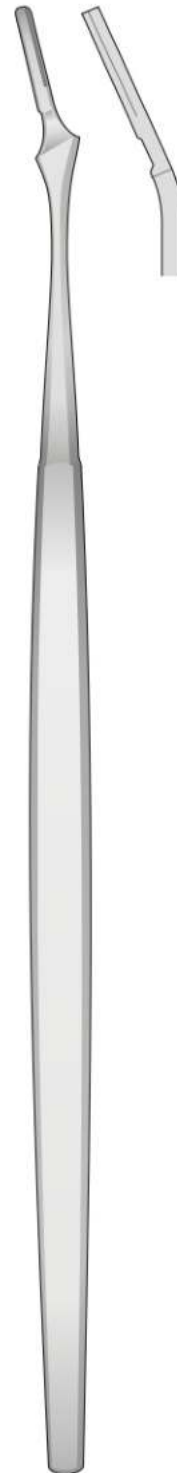
ST-9723
Fig. 3L



ST-9724
Fig. 3LA



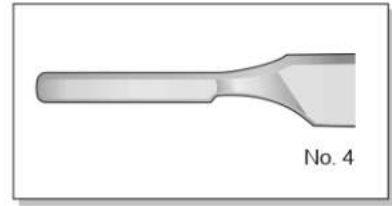
ST-9725
210 mm



ST-9726
210 mm



ST-9727
210 mm



ST-9728
Fig. 4



ST-9729
Fig. 4L




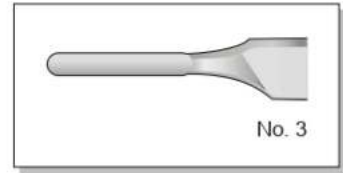
ST-9730
Fig. 4LA



ST-9731
Fig. 8

Scatole da 100 pezzi
Packungen à 100
Packages of 100 ea
Boîtes de 100 pièces
Cajas de 100 c/u

Doppio taglio
Double cutting
Doppelschneidig
Deux tranchants
Doble corta

ST-9732
Fig. 10



ST-9733
Fig. 11



ST-9734
Fig. 12



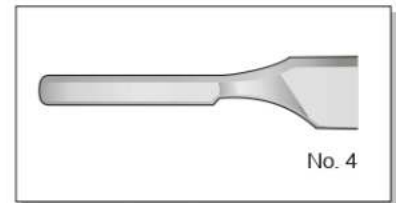
ST-9735
Fig. 12D



ST-9736
Fig. 13



ST-9737
Fig. 15



ST-9738
Fig. 18



ST-9739
Fig. 20



ST-9740
Fig. 21



ST-9741
Fig. 22



ST-9742
Fig. 23



ST-9743
Fig. 24



ST-9744
Fig. 25



ST-9745
Fig. 36



ST-9746
Conf. 10 pz.



ST-9747
Conf. 10 pz.



ST-9748
Conf. 1 pz.



ST-9749
Conf. 10 pz.



ST-9750
Conf. 10 pz.



ST-9751
Conf. 1 pz.



ST-9752
Conf. 10 pz.



ST-9753
Conf. 10 pz.



ST-9754
Conf. 1 pz.



ST-9755
100 mm



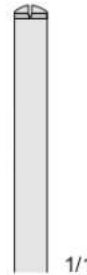
ST-9756
150 mm



ST-9757
135 mm



ST-9758 155 mm
ST-9759 180 mm
ST-9760 200 mm



1/1

CASPAR
02-530-18



1/1

02-530-20



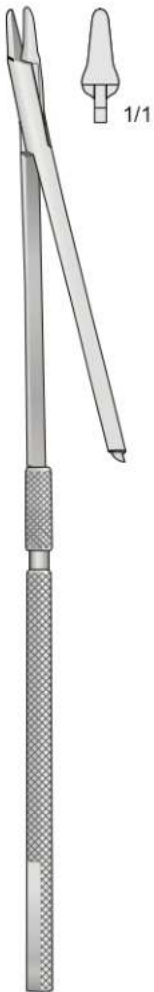
LANDOLT
ST-9761
210 mm



LANDOLT
ST-9762
250 mm



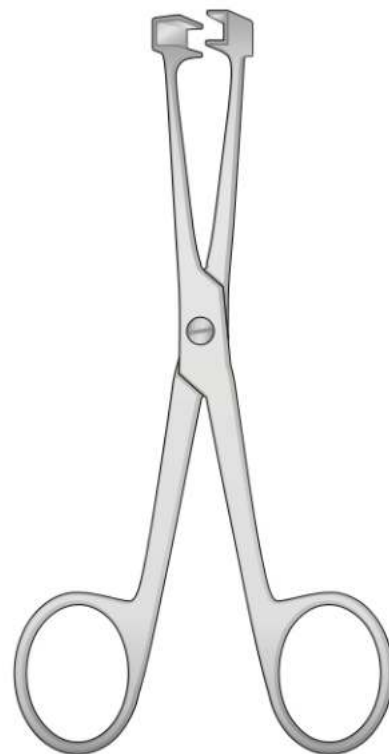
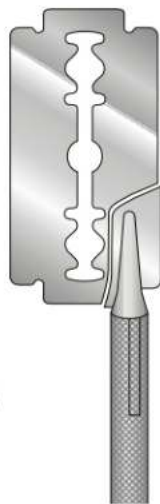
ST-9763
Scatola da 10 lame
Package 10 blades
Packung 10 Klengen
Boite de 10 lames
Cajita de 10 hojas



ST-9764
180 mm



ST-9765
120 mm



ST-9766
135 mm

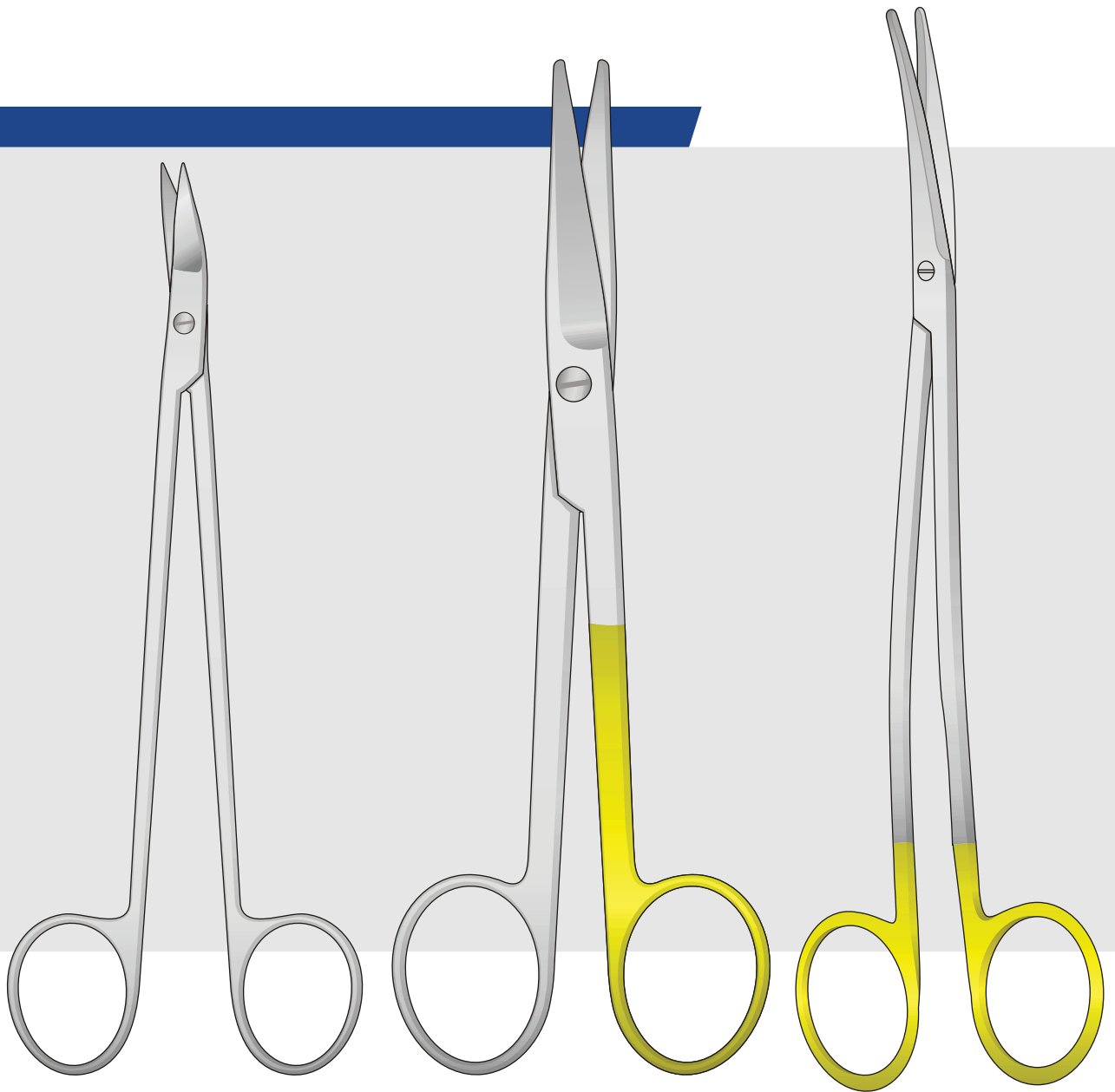


ST-9767
115 mm



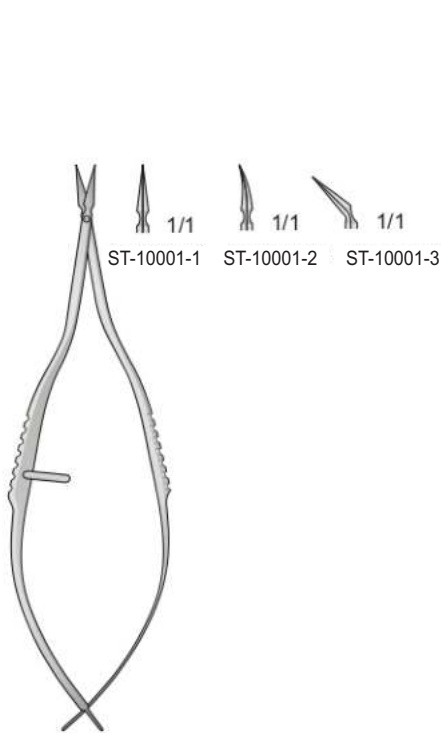
SAFE TOOL
MANUFACTURER & EXPORTER

SURGICAL SCISSORS



www.safetool.com.pk

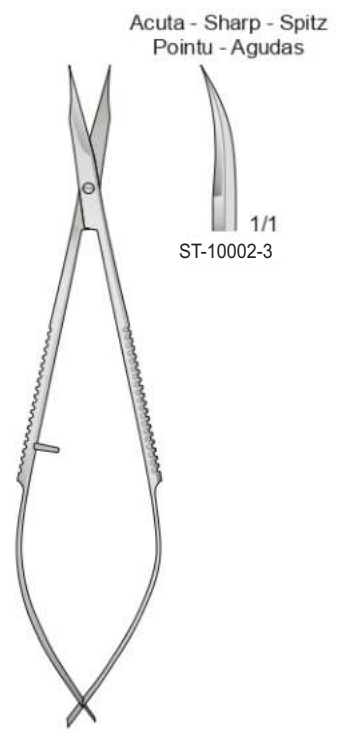
***Surgical
Instruments***



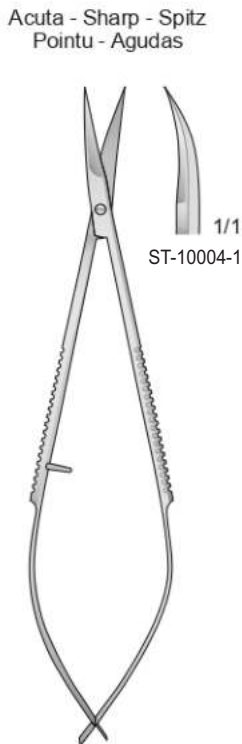
VANNAS
ST-10001
85 mm



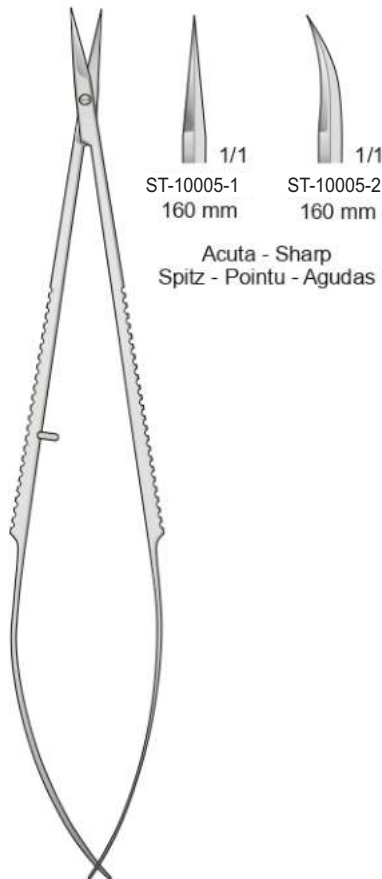
NOYES
ST-10002
120 mm



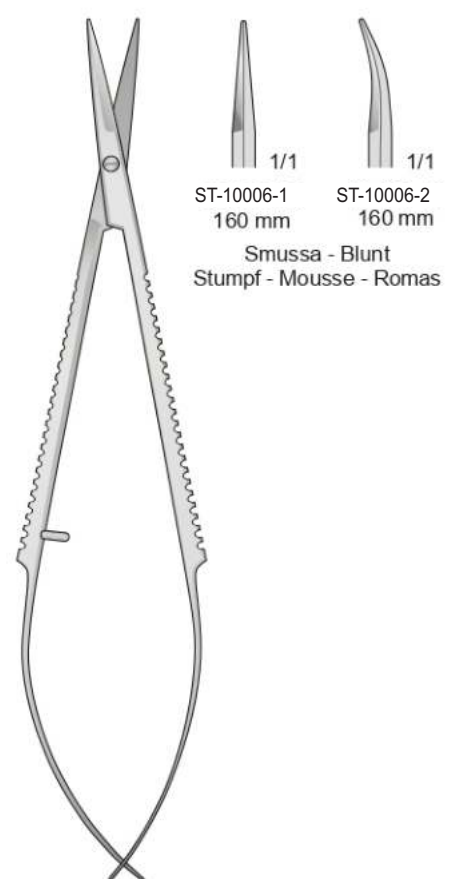
WESTCOTT
ST-10003
120 mm



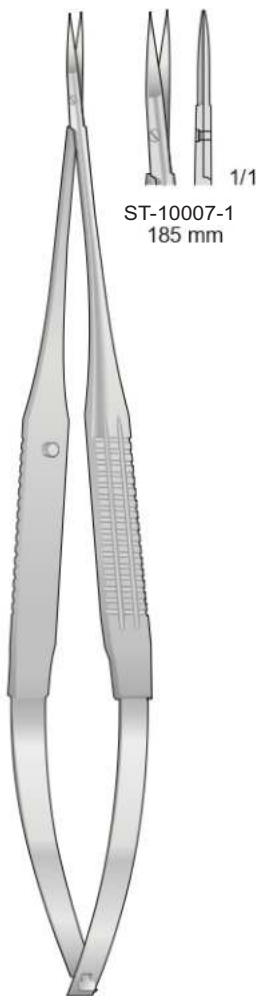
NOYES
ST-10004
120 mm



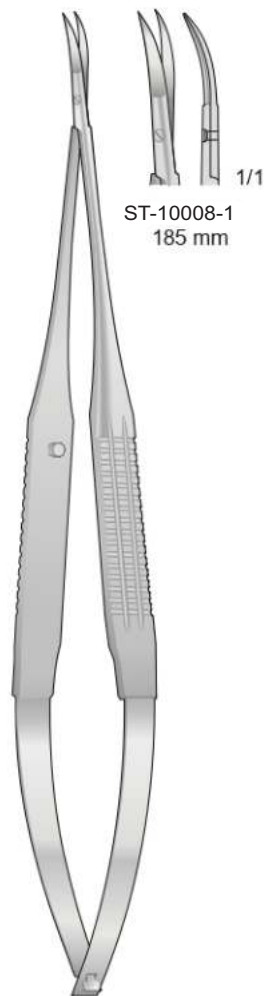
ST-10005
160 mm



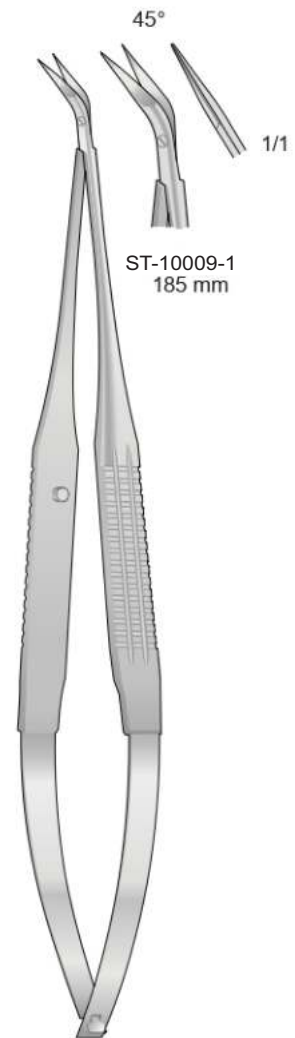
ST-10006
160 mm



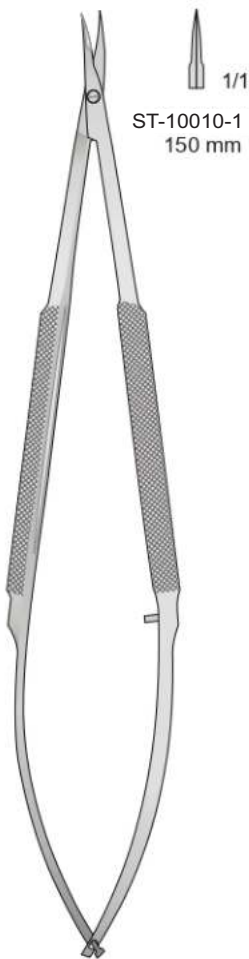
YASARGIL
ST-10007
185 mm



JACOBSON
ST-10008
185 mm



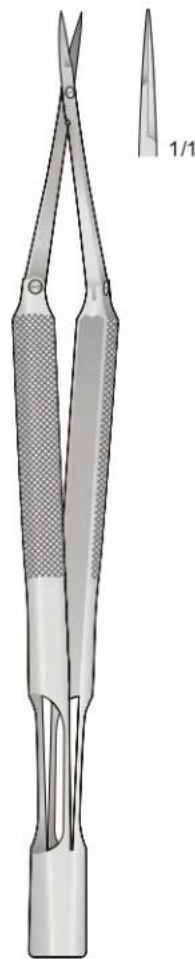
POTTS-YASARGIL
ST-10009
185 mm



ST-10010-1
150 mm



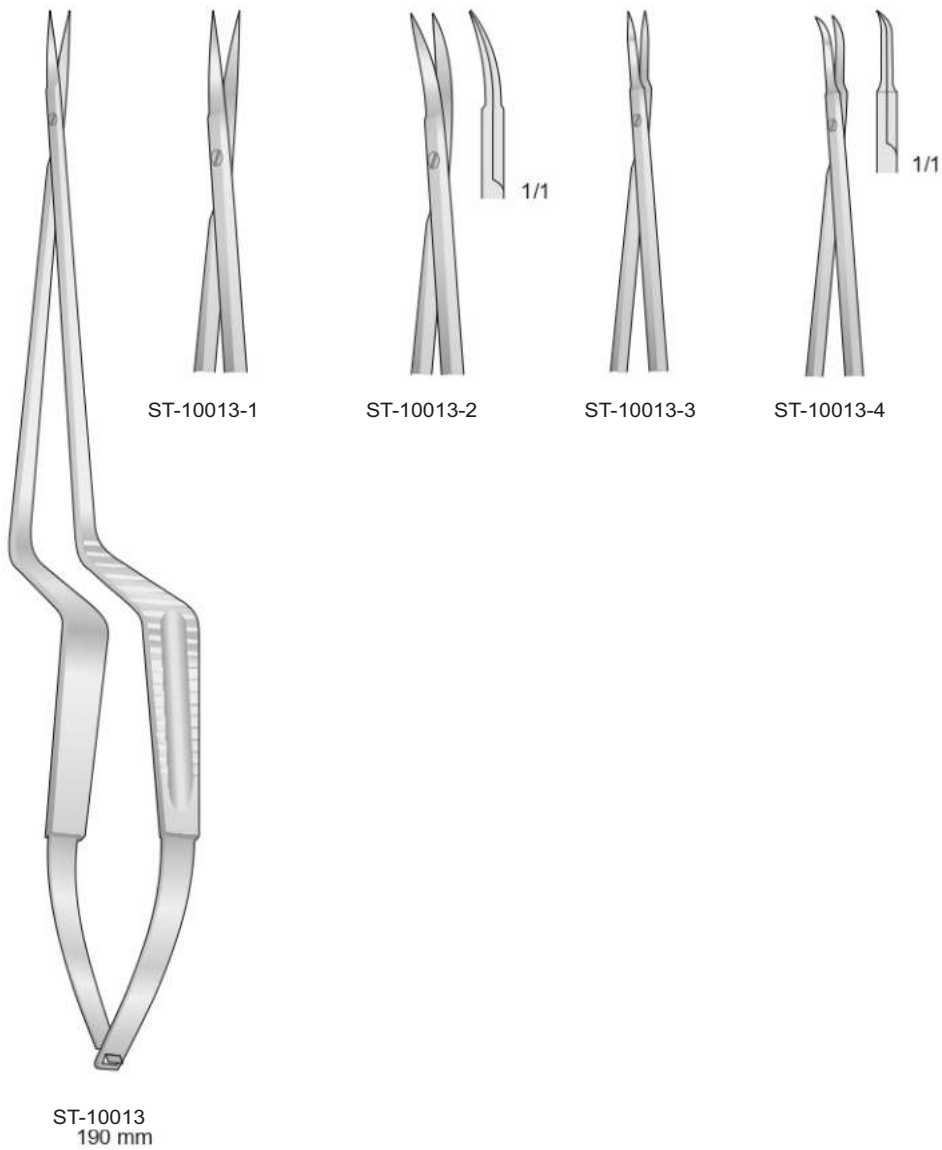
ST-10010-2
150 mm



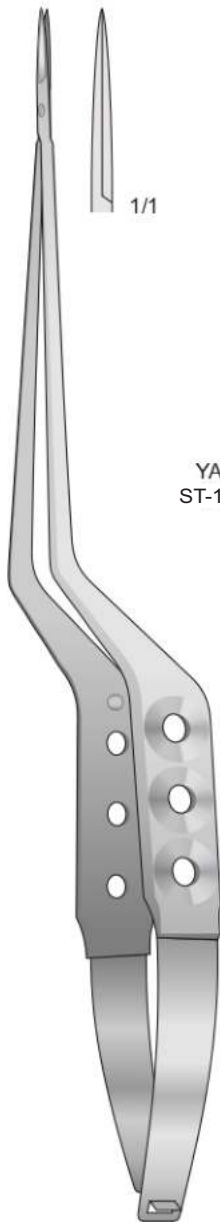
BROCK
ST-10011
150 mm



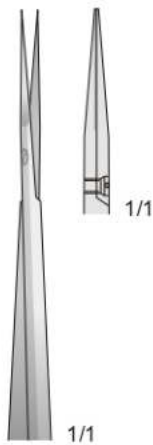
BROCK
ST-10012
150 mm



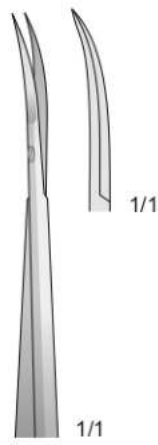
Dentellata
Sawedge
Gezahnt
Dentelés
Dentadas



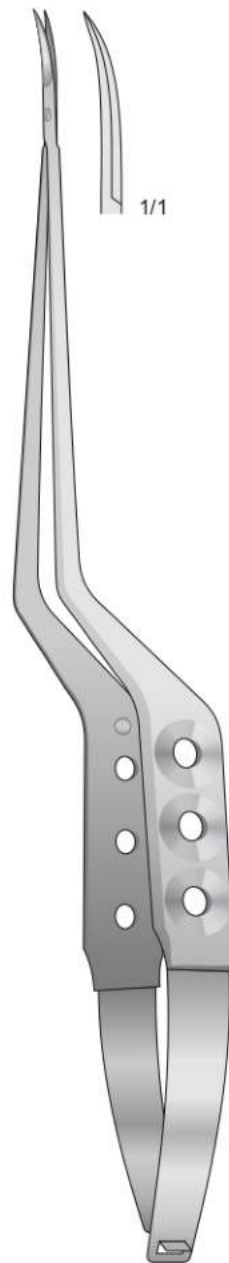
YASARGIL
ST-10014
225 mm



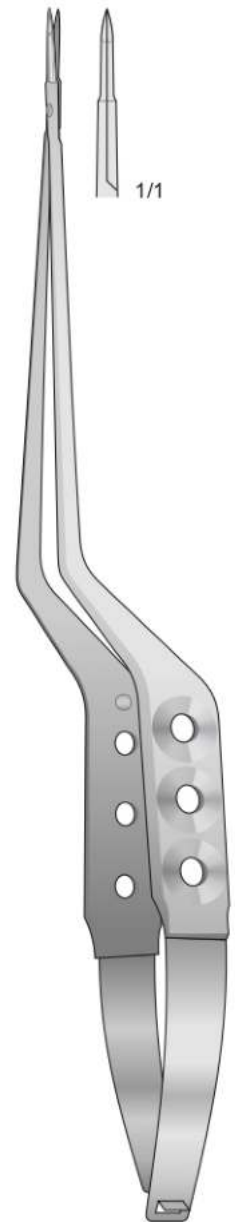
YASARGIL
ST-10014-1



YASARGIL
ST-10014-2



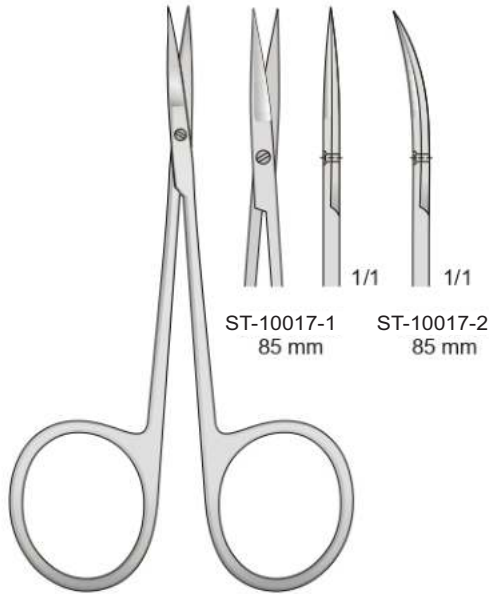
YASARGIL
ST-10015
245 mm



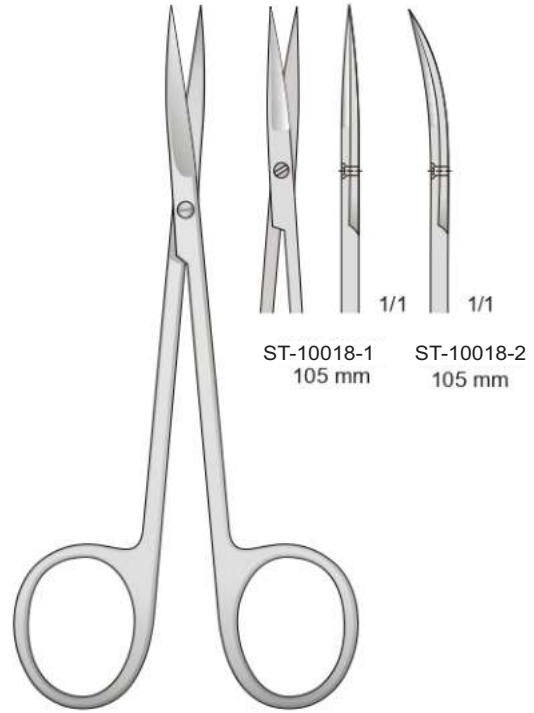
VANNAS
ST-10016
225 mm



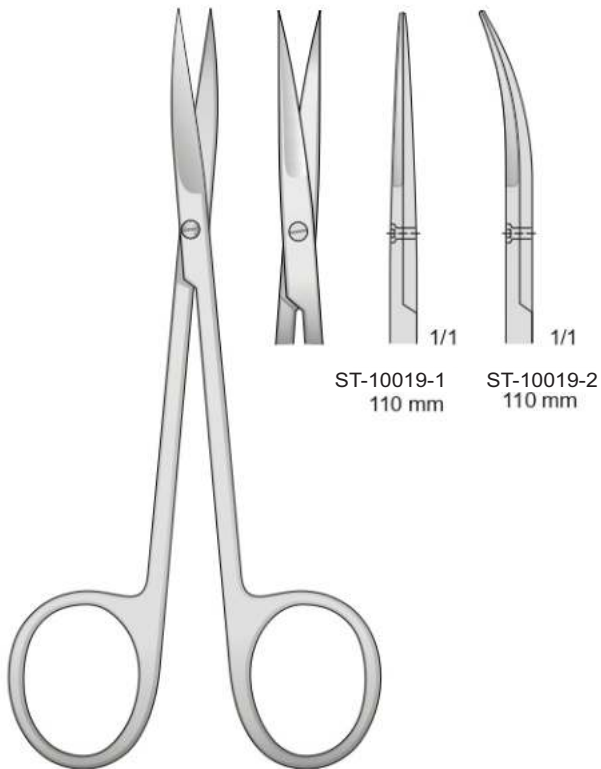
Acute
Pointed
Spitz
Pointus
Agudas



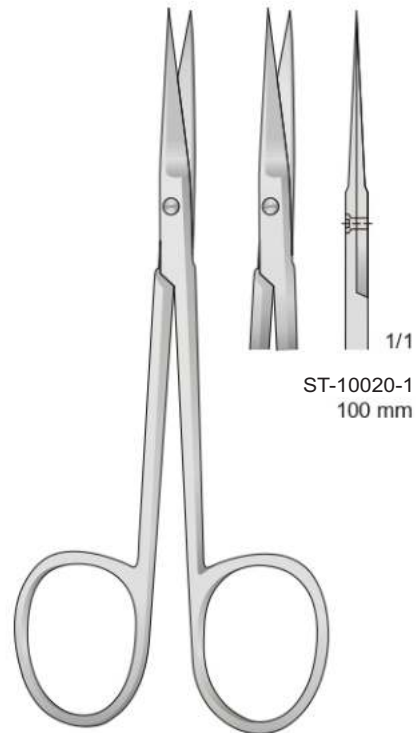
MICRO-IRIS
ST-10017
85 mm



ST-10018
105 mm



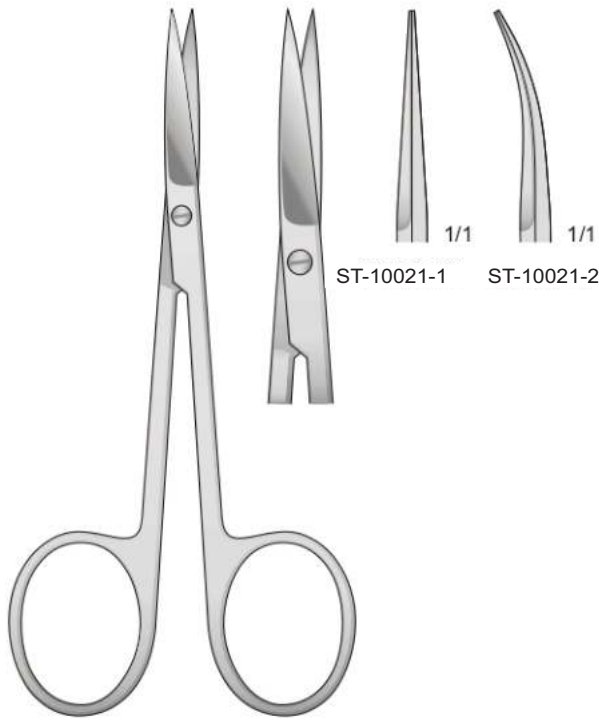
IRIS
ST-10019
110 mm



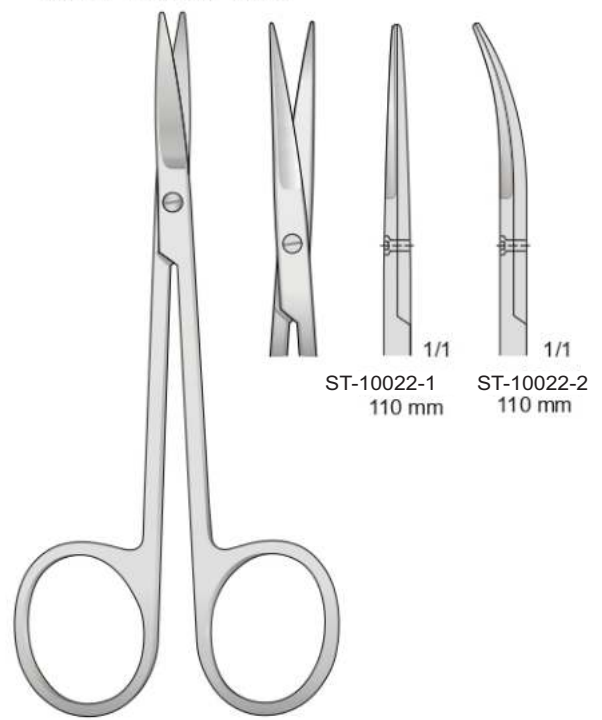
ST-10020
100 mm



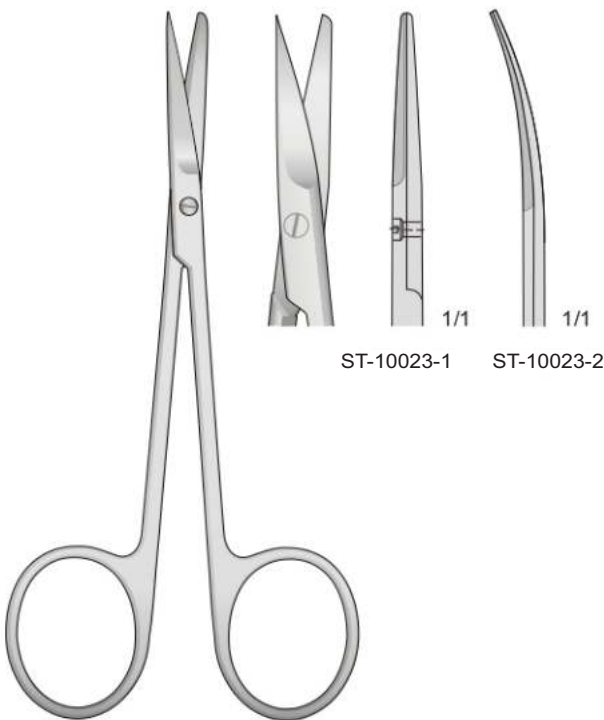
Smussa - Blunt
Stumpf - Émoussé - Romo



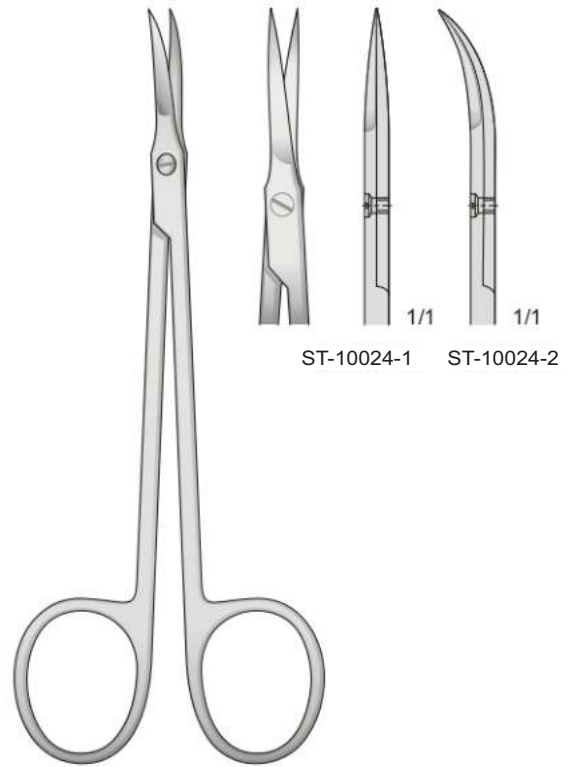
ST-10021
110 mm



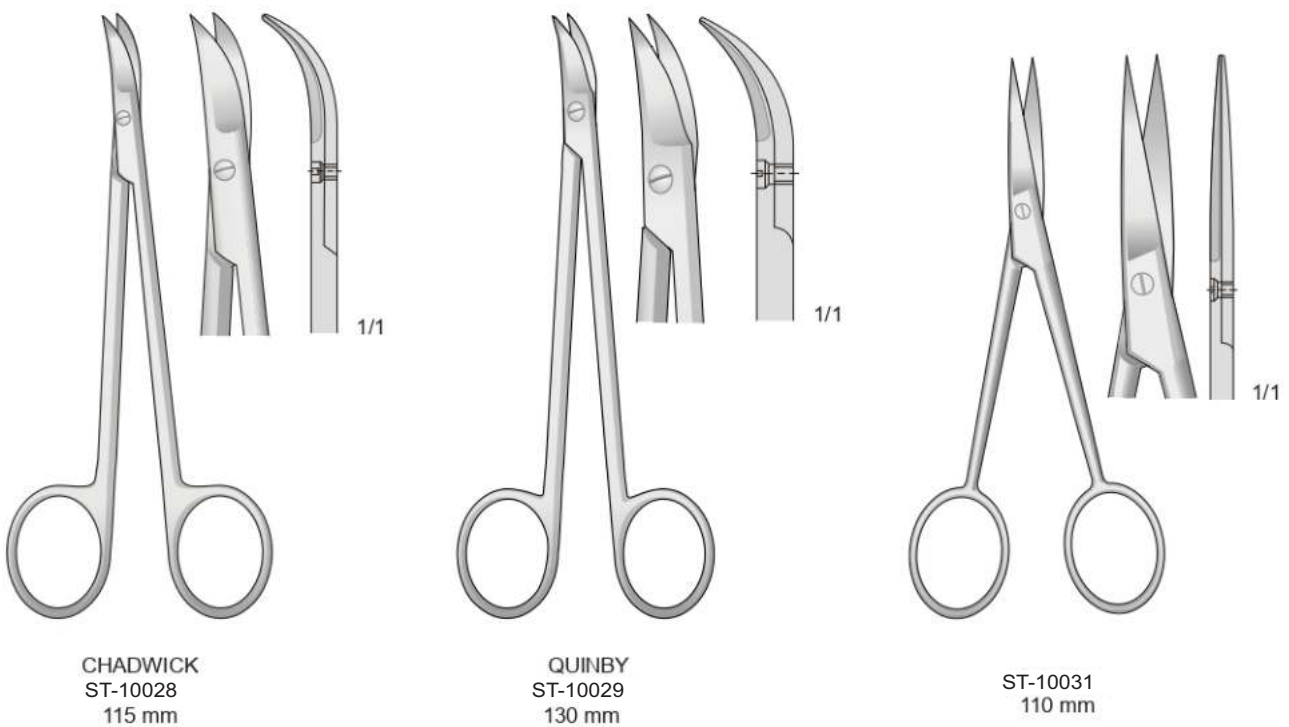
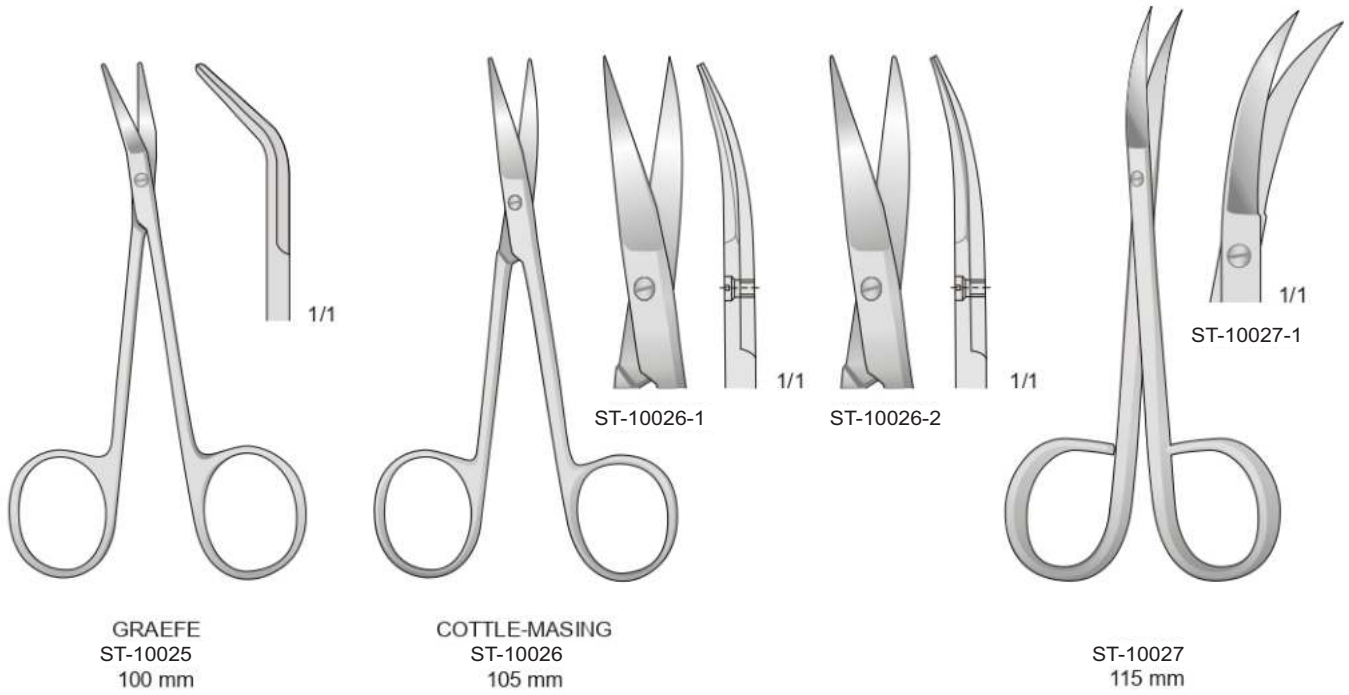
ST-10022
110 mm

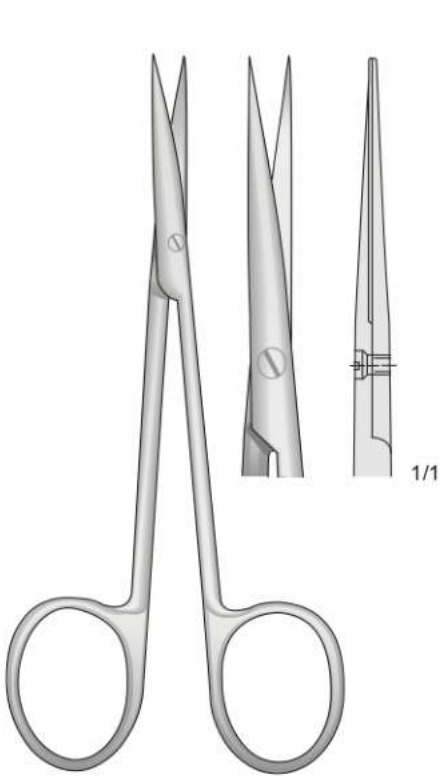


ST-10023
110 mm

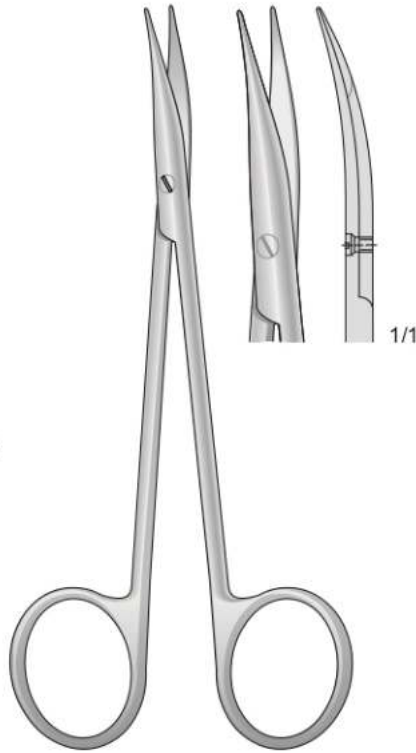


ST-10024
120 mm

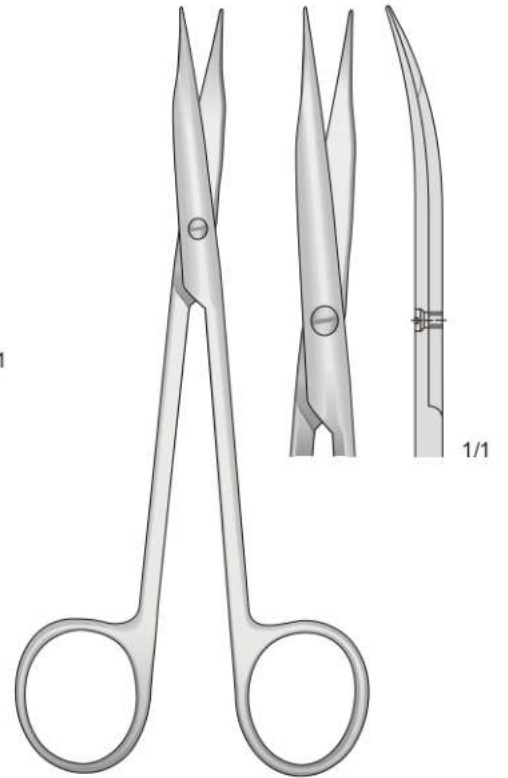




KILNER
ST-10032
115 mm

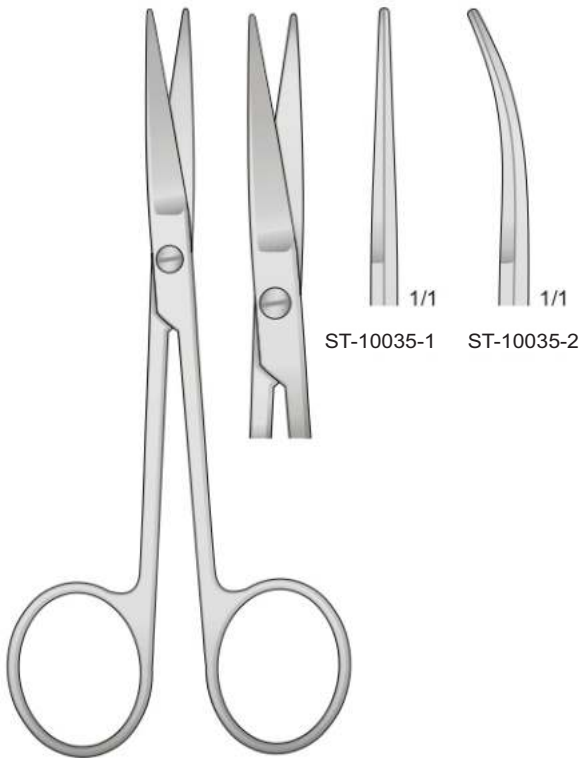


JAMESON-WERBER
ST-10033
130 mm



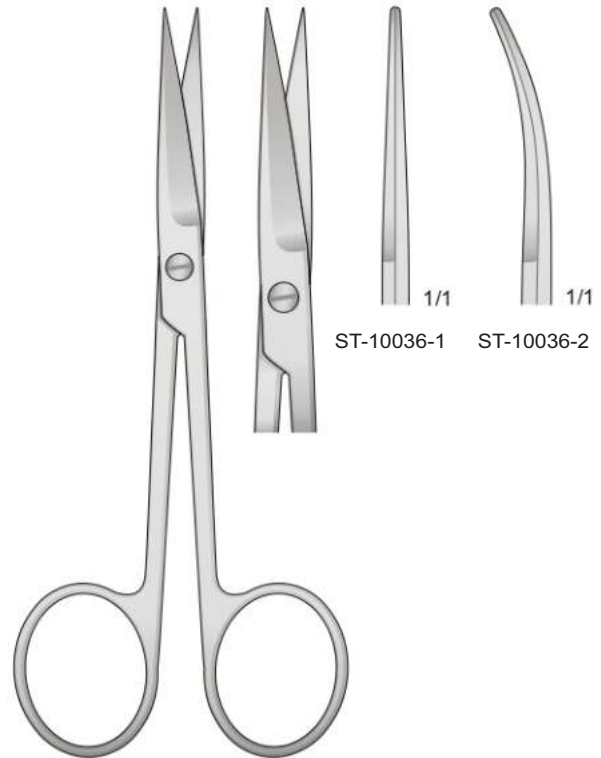
JAMESON
ST-10034
145 mm

Smussa - Blunt
Stumpf - Émoussé - Romo

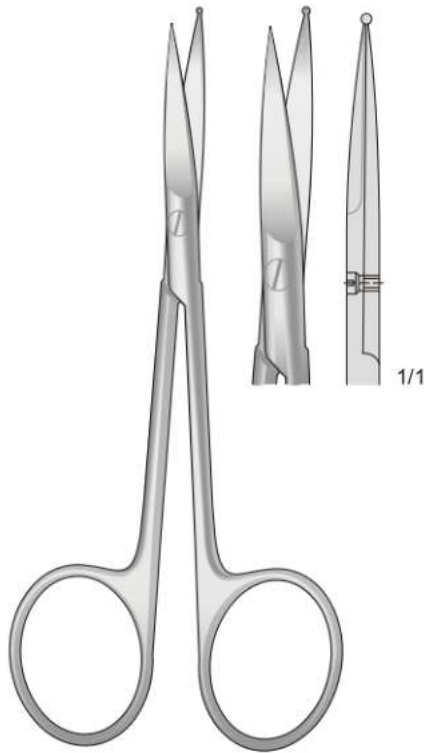


ST-10035
115 mm

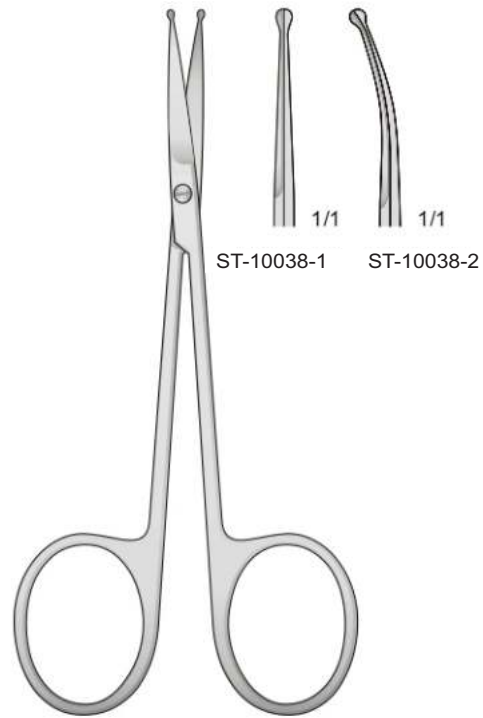
Acuta - Sharp
Spitz - Aigu - Agudo



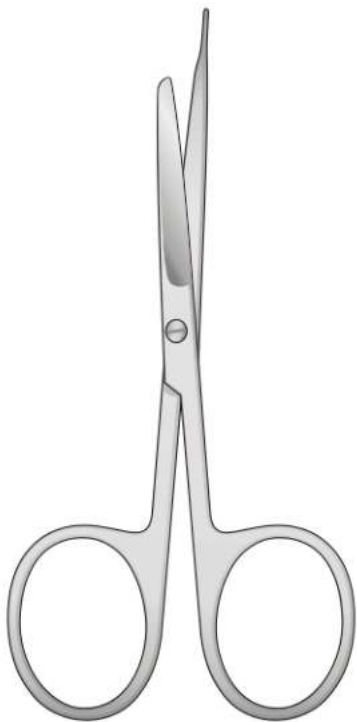
ST-10036
115 mm



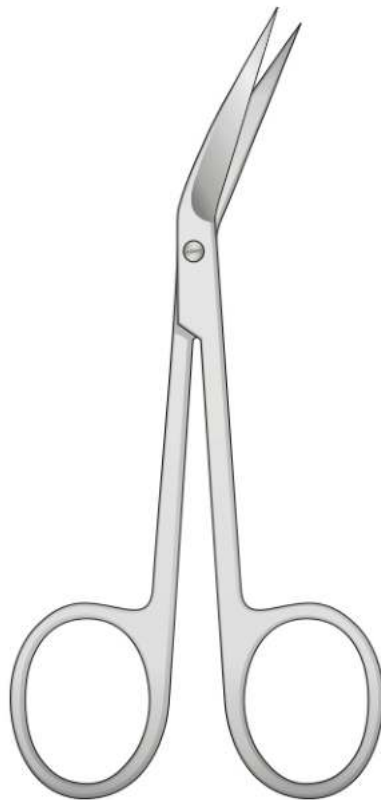
ST-10037
120 mm



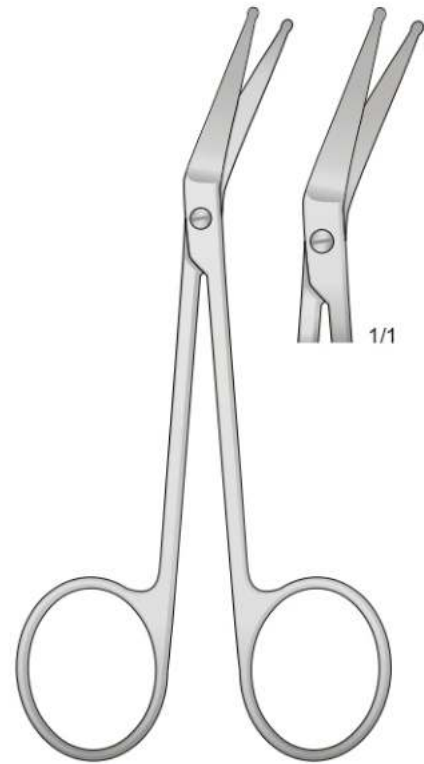
ST-10038
110 mm



ST-10039
100 mm



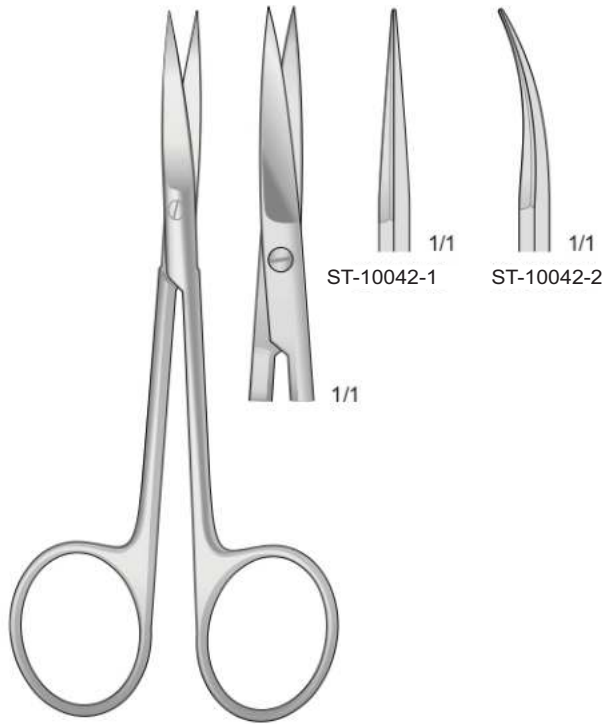
ST-10040
115 mm



LOCKLIN MOD.
ST-10041
110 mm

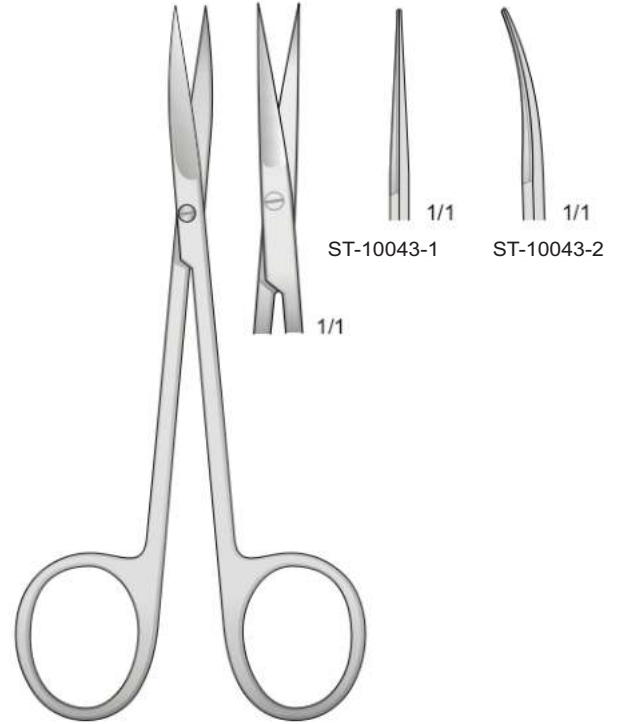


Dentellata - Sawedge - Gezahnt - Dentelé - Dentadas



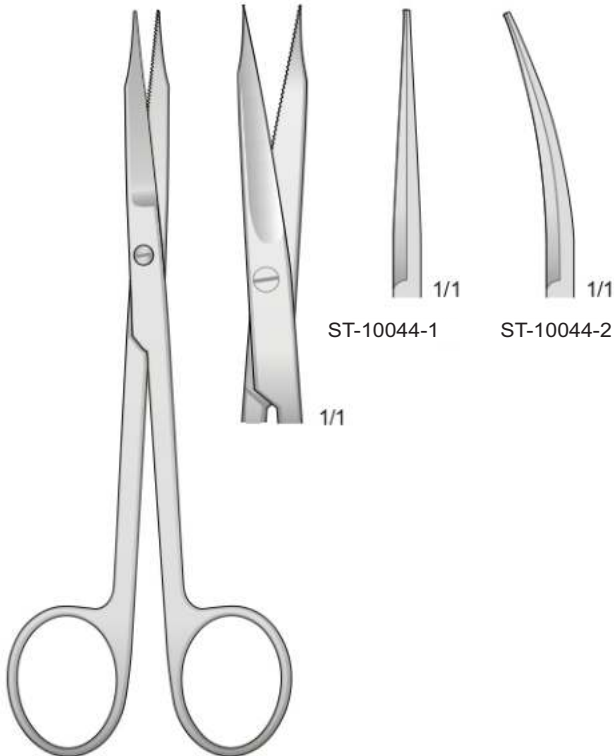
ST-10042
110 mm

Dentellata - Sawedge - Gezahnt - Dentelé - Dentadas



ST-10043
110 mm

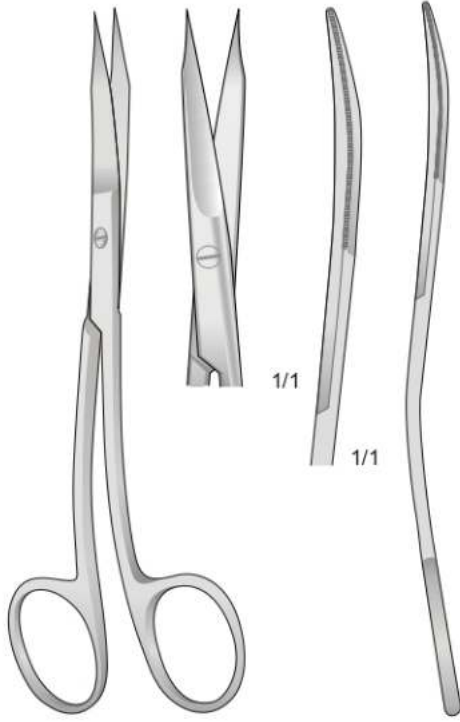
Dentellata - Sawedge - Gezahnt - Dentelé - Dentadas



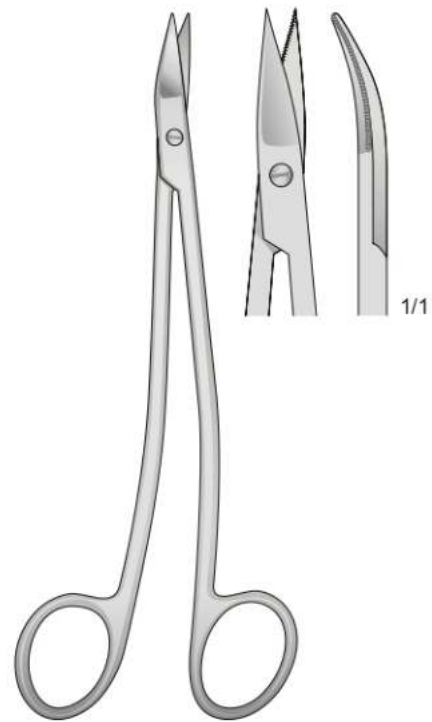
GOLDMAN-FOX
ST-10044
120 mm



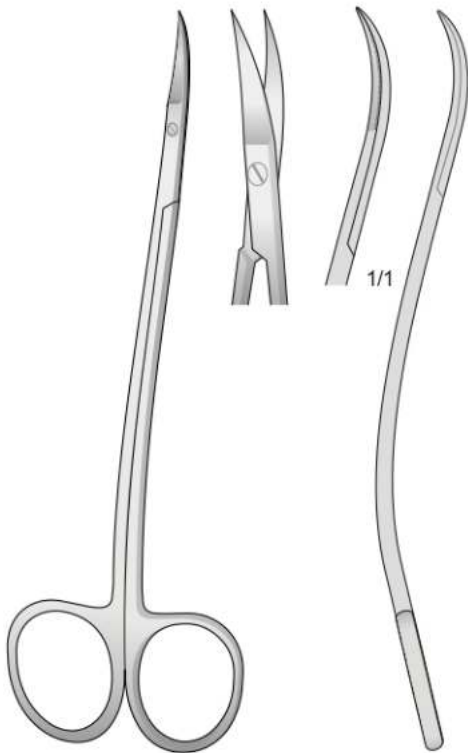
Dentellate
Saw edge
Gezahnt
Dentelé
Dentadas



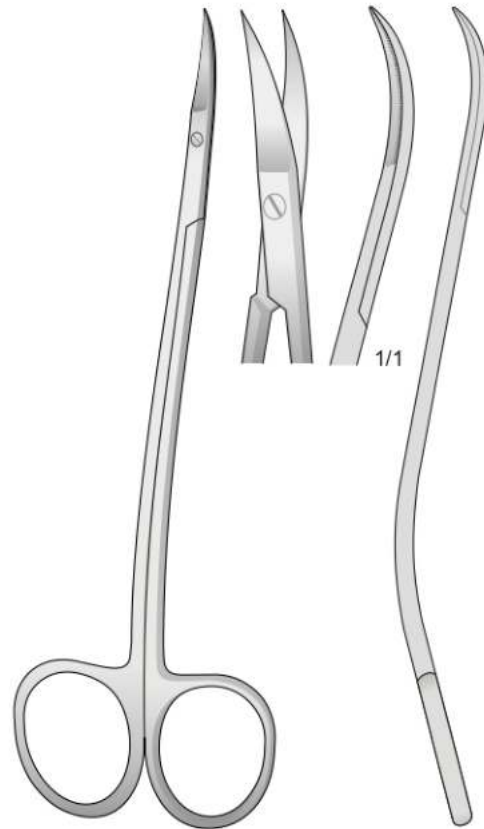
GOLDMAN-FOX S FORM
ST-10045
130 mm



NEUMANN
ST-10046
130 mm



LA GRANGE
ST-10047
115 mm

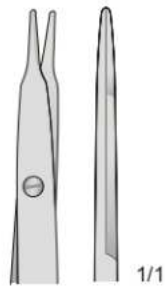
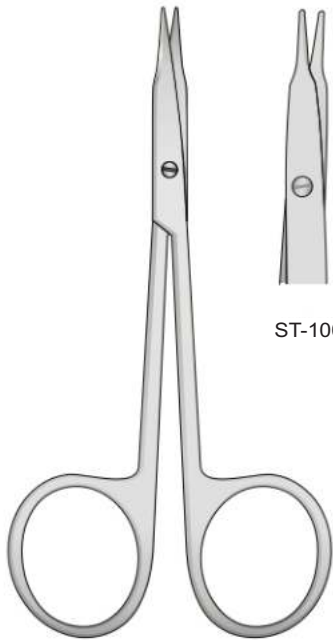


LA GRANGE
ST-10048
155 mm



Smusse - Blunt - Stumpf - Mousses - Romas

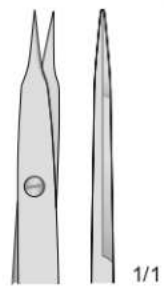
Acute - Pointed - Spitz - Pointus - Agudas



ST-10049-1



ST-10049-2



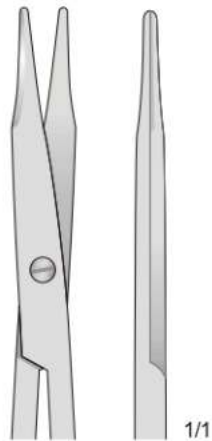
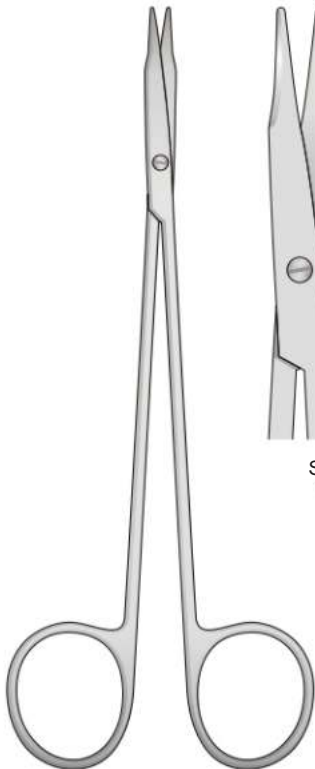
ST-10049-3



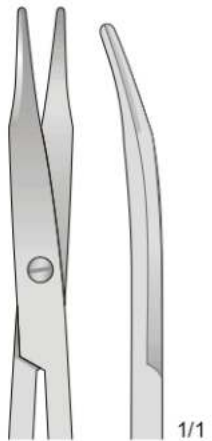
ST-10049-4

STEVENS
ST-10049
110 mm

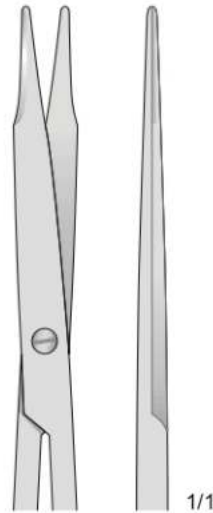
Smussa - Blunt - Stumpf
Mousse - Romas



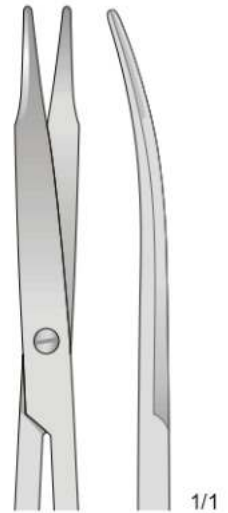
ST-10050-1
150 mm



ST-10050-2
150 mm

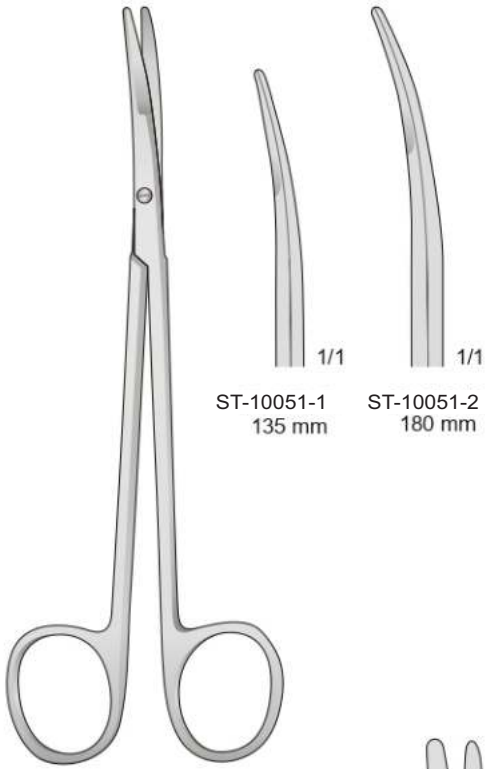


ST-10050-3
180 mm

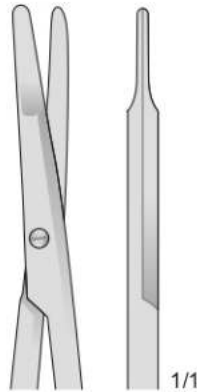


ST-10050-4
180 mm

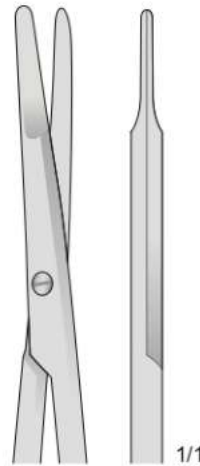
REYNOLDS
ST-10050



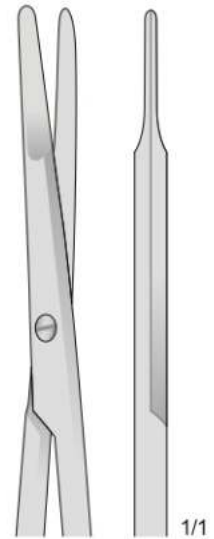
GLASSMAN
ST-10051



ST-10052-1
120 mm



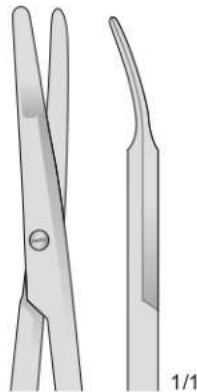
ST-10052-2
135 mm



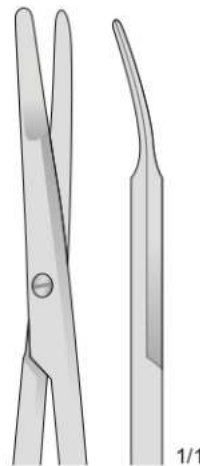
ST-10052-3
150 mm



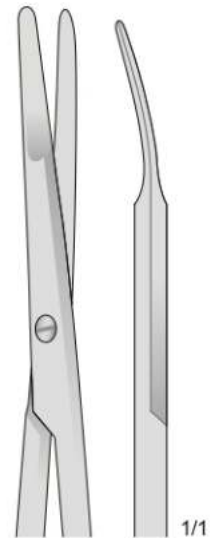
KILNER
ST-10052



ST-10052-4
120 mm



ST-10052-5
135 mm



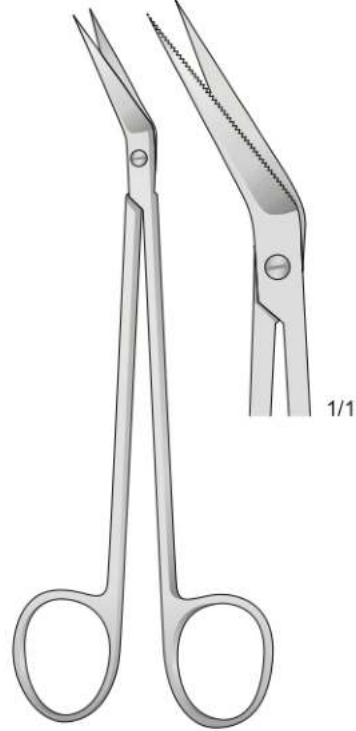
ST-10052-6
150 mm



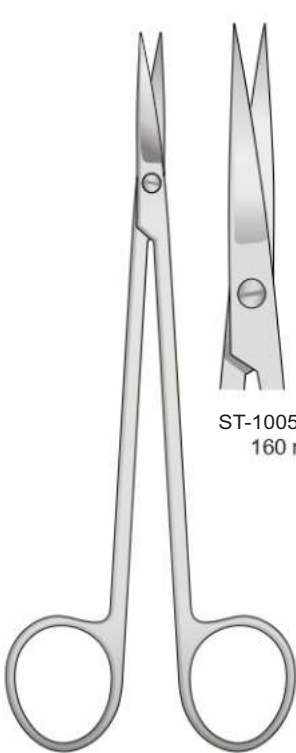
Dentellate
Saw edge
Gezahnt
Dentelés
Dentadas



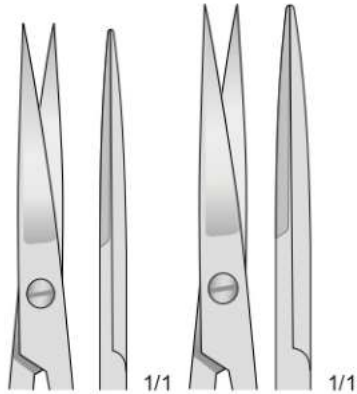
LOCKLIN
ST-10053
160 mm



LOCKLIN
ST-10054
160 mm

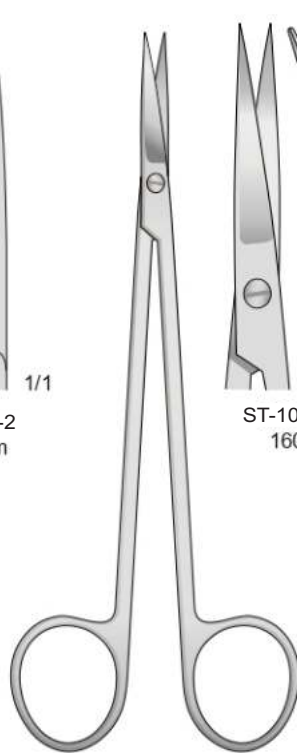


KELLY
ST-10055

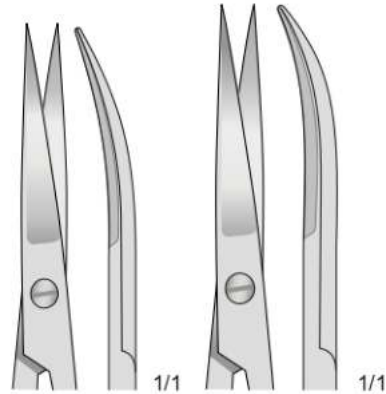


ST-10055-1
160 mm

ST-10055-2
180 mm

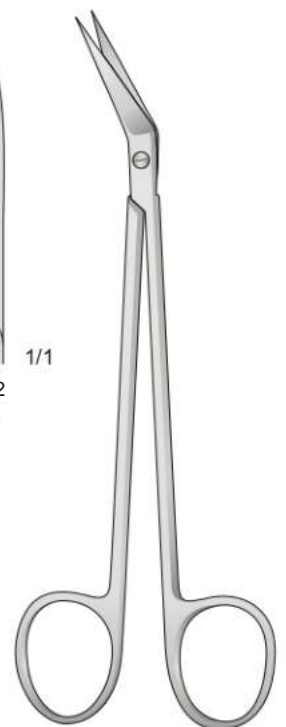


KELLY
ST-10056



ST-10056-1
160 mm

ST-10056-2
180 mm



KELLY
ST-10057
160 mm



Standard

Smusse
Blunt
Stumpf
Mousses
Romas



ST-10058

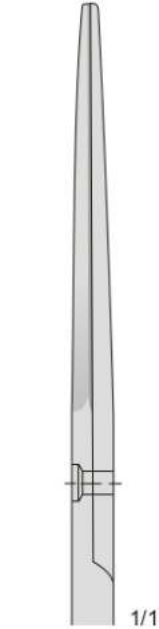


1/1



1/1

ST-10058-1
130 mm



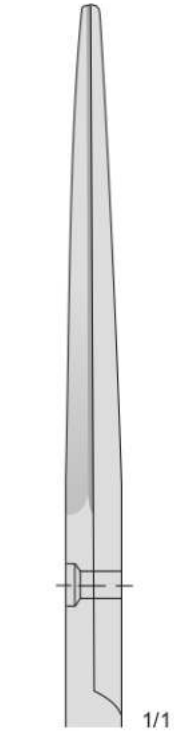
1/1

ST-10058-2
145 mm



1/1

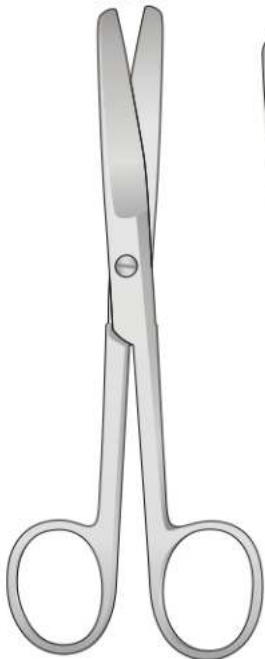
ST-10058-3
165 mm



1/1

ST-10058-4
185 mm

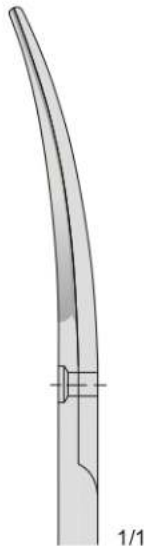
Smusse - Blunt
Stumpf - Mousses
Romas



ST-10059

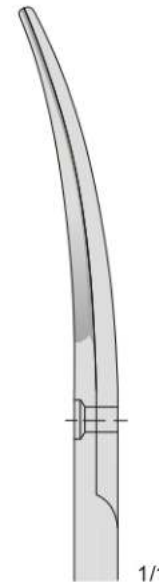


1/1



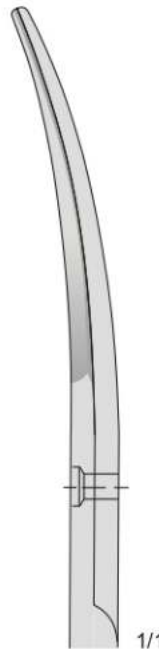
1/1

ST-10059-1
130 mm



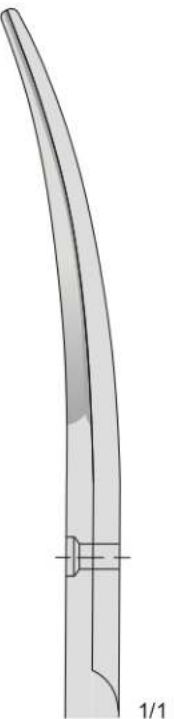
1/1

ST-10059-2
145 mm



1/1

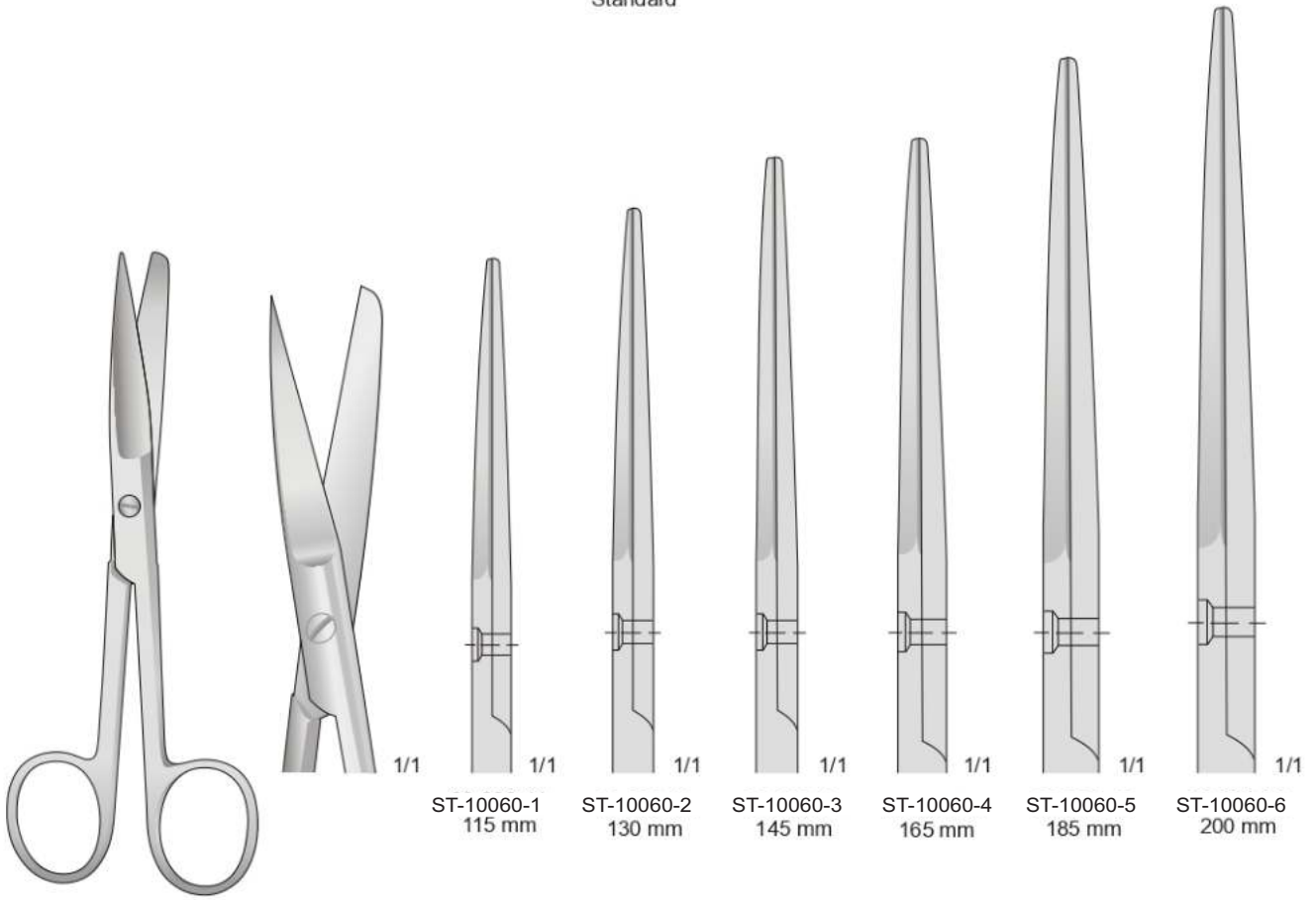
ST-10059-3
165 mm



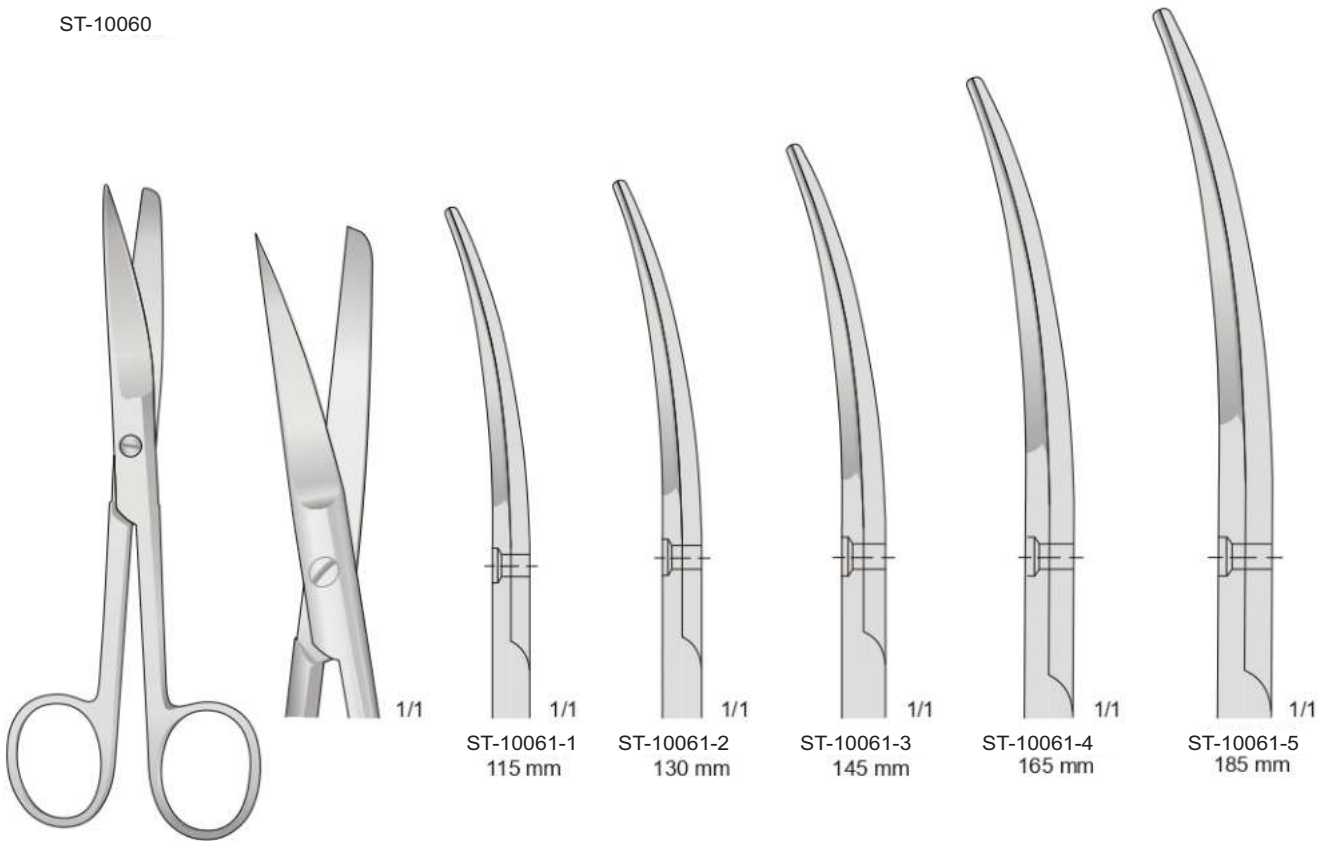
1/1

ST-10059-4
185 mm

Standard



ST-10060



ST-10061

Standard

Acuta - Sharp
Spitz - Aigu - Agudo



1/1



1/1

ST-10062-1
130 mm



1/1

ST-10062-2
145 mm



1/1

ST-10062-3
165 mm



1/1

ST-10062-4
185 mm



1/1

ST-10062-5
200 mm

ST-10062

Acuta - Sharp
Spitz - Aigu - Agudo



1/1



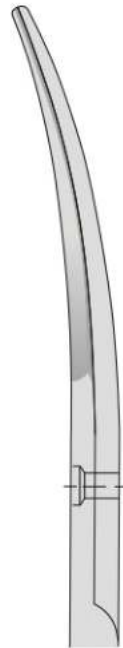
1/1

ST-10063-1
130 mm



1/1

ST-10063-2
145 mm



1/1

ST-10063-3
165 mm



1/1

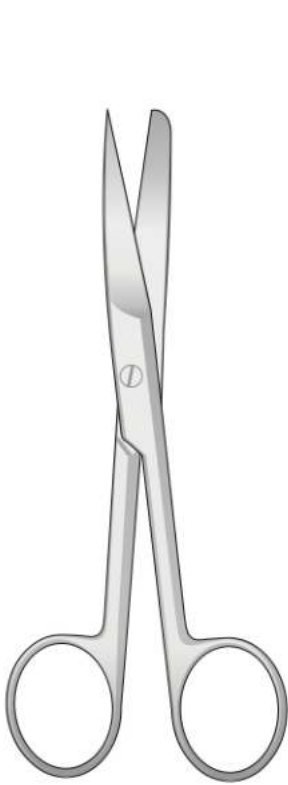
ST-10063-4
185 mm



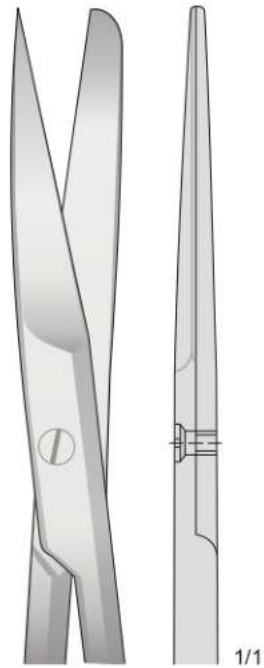
1/1

ST-10063-5
200 mm

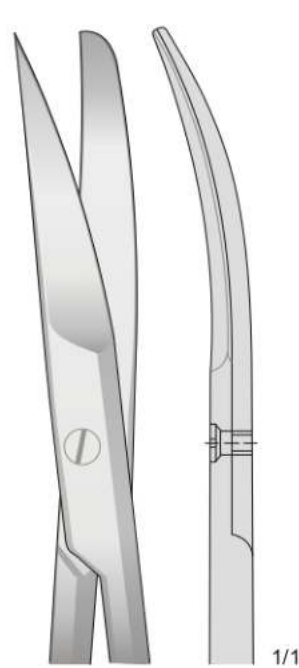
ST-10063



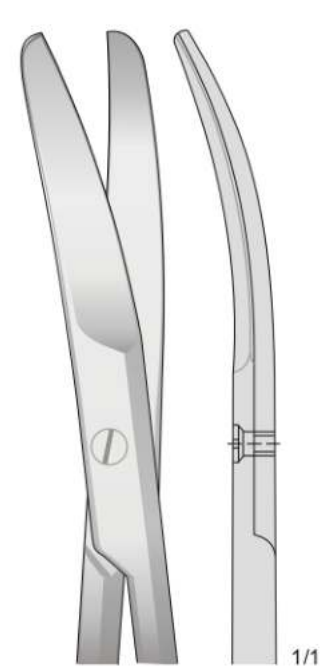
DEAVER
ST-10064
145 mm



ST-10064-1
145 mm

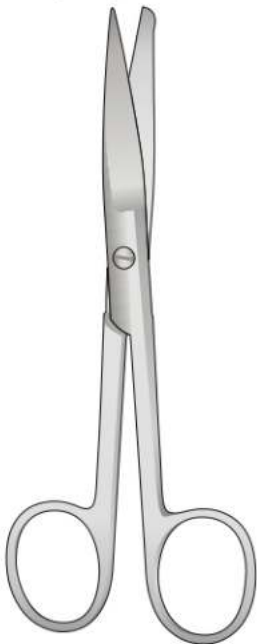


ST-10064-2
145 mm



ST-10064-3
145 mm

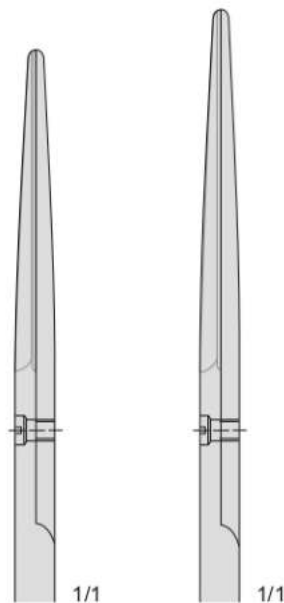
Forbici da incisione - Incision scissors
Inzisionscheren - Ciseaux à incision
Tijeras para incisión



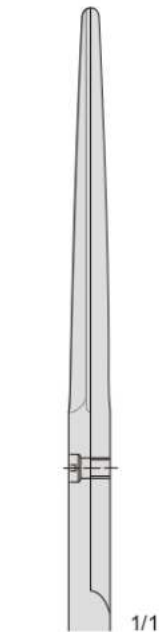
ST-10065



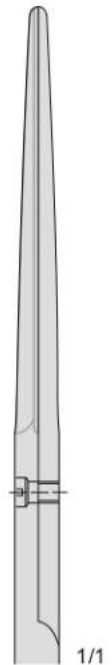
ST-10065-1
130 mm



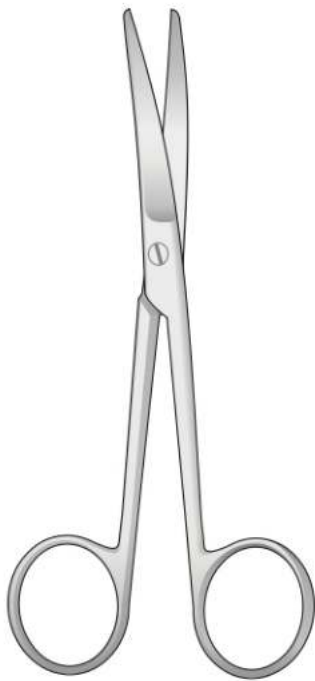
ST-10065-2
145 mm



ST-10065-3
165 mm



ST-10065-4
185 mm



WERTHEIM
ST-10066



1/1



1/1

ST-10066-1
145 mm



1/1

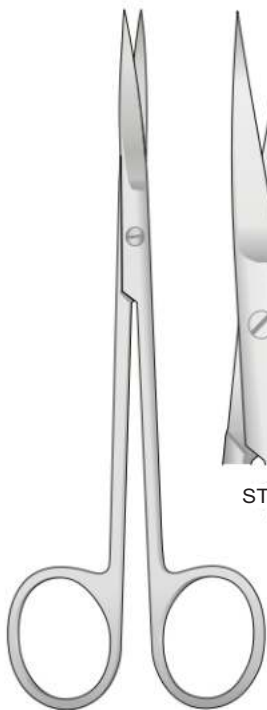
ST-10066-2
200 mm



1/1

ST-10066-3
230 mm

Con una lama dentellata
With one blade serrated
Mit eine Schneide gezahnt
Avec lame dentée
Con una hoja dentada



JOSEPH
ST-10067
150 mm



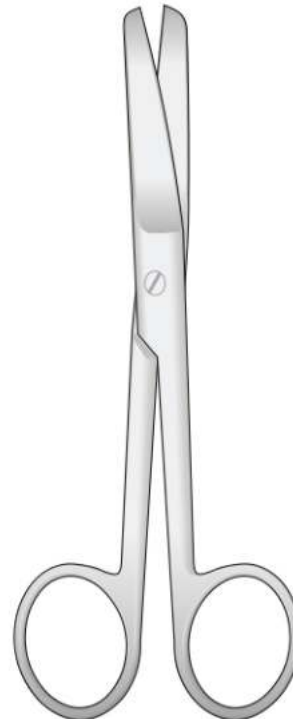
1/1

ST-10067-1
150 mm



1/1

ST-10067-2
150 mm



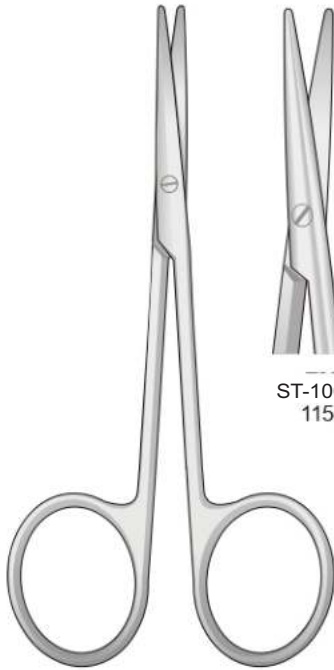
ST-10068
165 mm



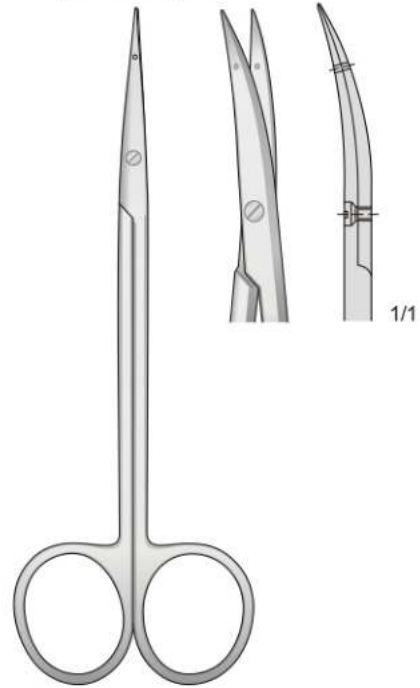
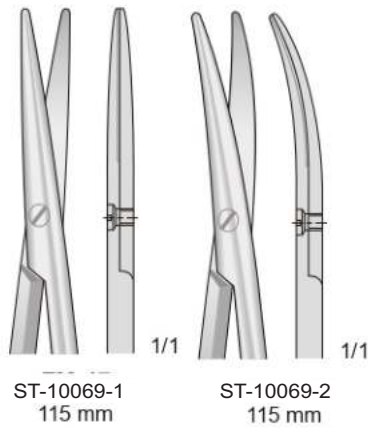
1/1



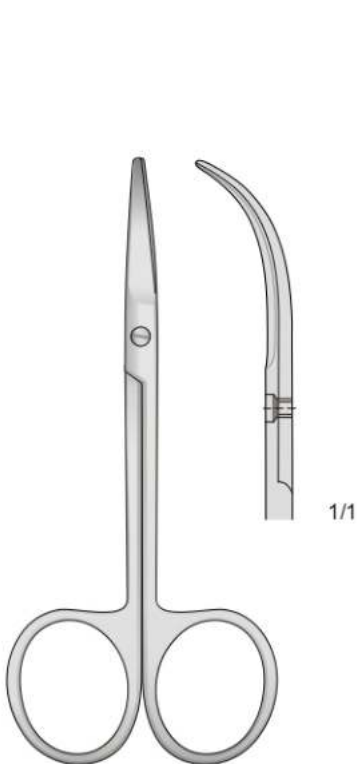
Con occhiello per sutura - With eye for suture
Mit faden bohrung - Avec oeil pour les sutures
Tijeras para ligaduras



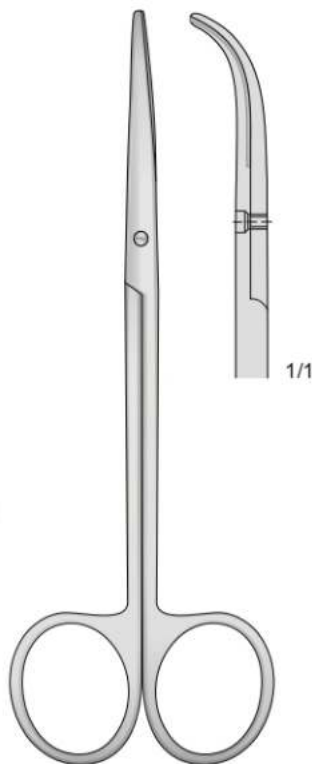
BABY - METZENBAUM
ST-10069
115 mm



LITTLER
ST-10070
120 mm



FOMON
ST-10071
110 mm



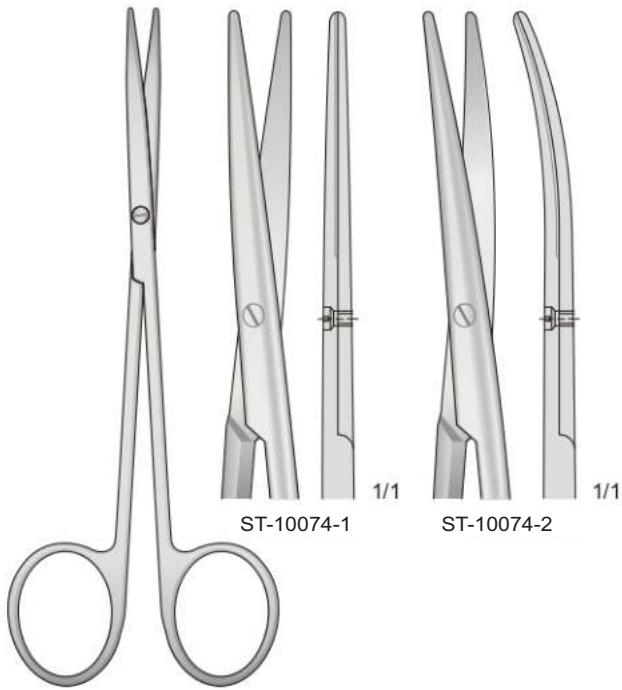
ST-10072
140 mm



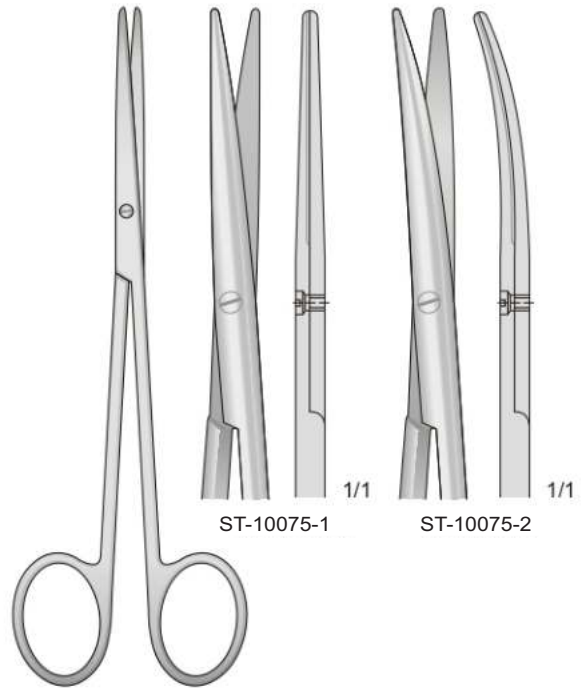
METZENBAUM
ST-10073
150 mm



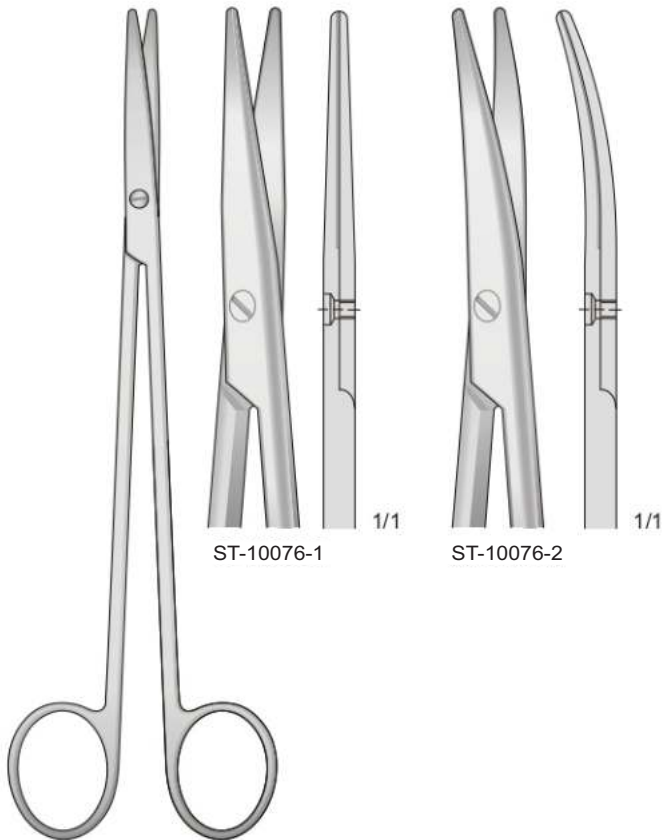
Forbici per dissezione - Dissecting Scissors
Präparierscheren - Ciseaux à dissection - Tijeras para preparaciones



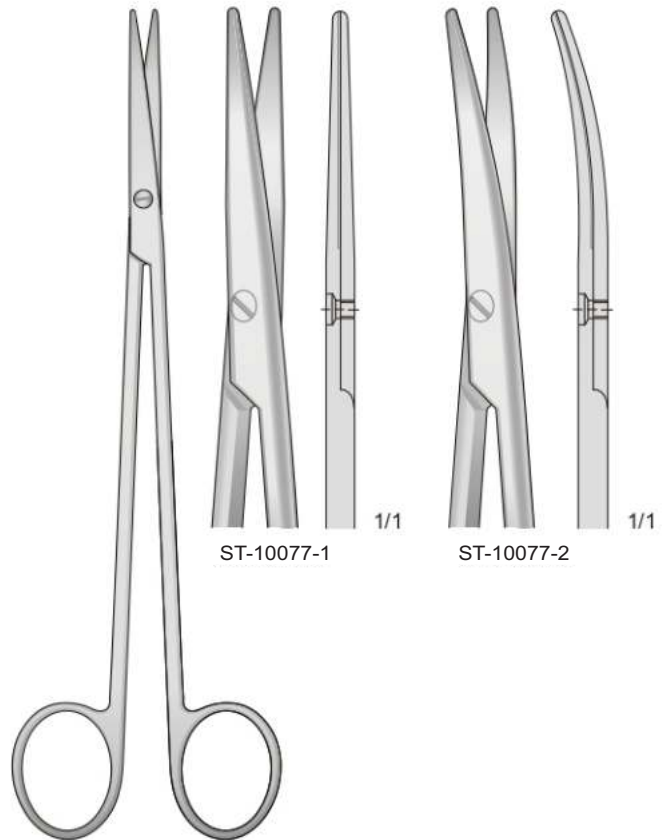
METZENBAUM
ST-10074
145 mm



METZENBAUM-FINE
ST-10075
145 mm



METZENBAUM
ST-10076
185 mm



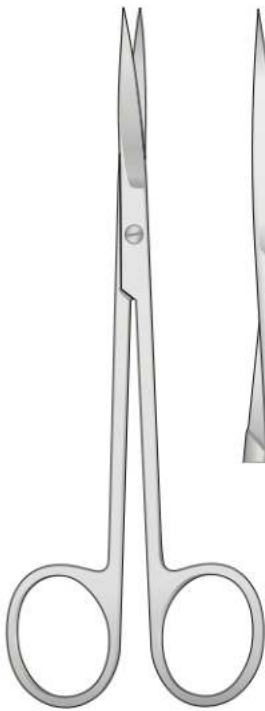
METZENBAUM-FINE
ST-10077
185 mm



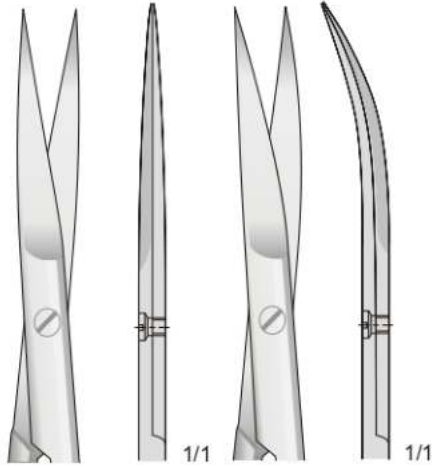
Forbici per dissezione - Dissecting Scissors

Präparierscheren - Ciseaux à dissection - Tijeras para preparaciones

Acuta - Sharp
Spitz - Aigu - Agudo

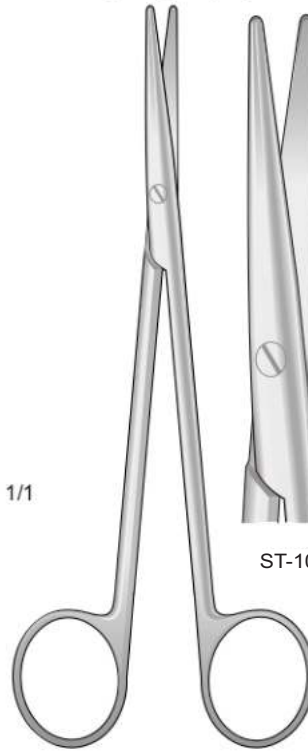


METZENBAUM
ST-10078
145 mm

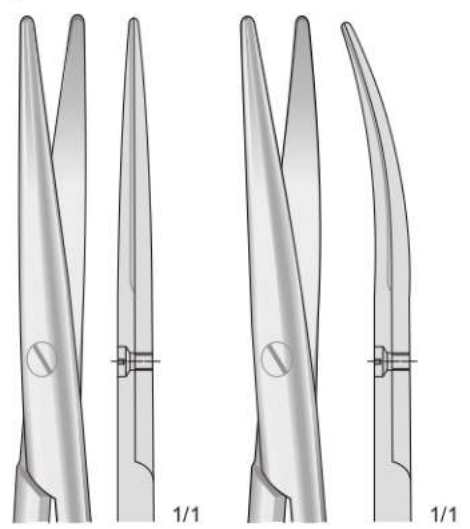


ST-10078-1

ST-10078-2

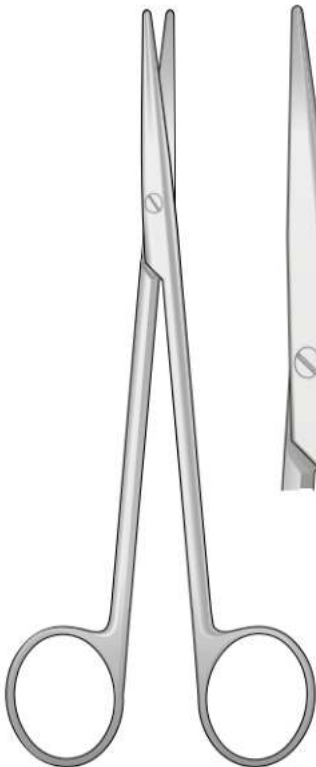


METZENBAUM
ST-10079
160 mm

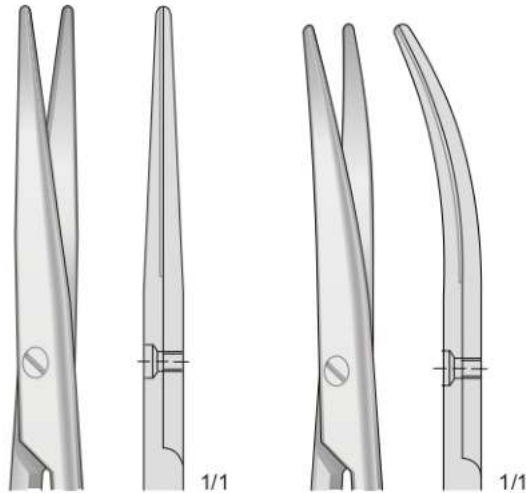


ST-10079-1

ST-10079-2

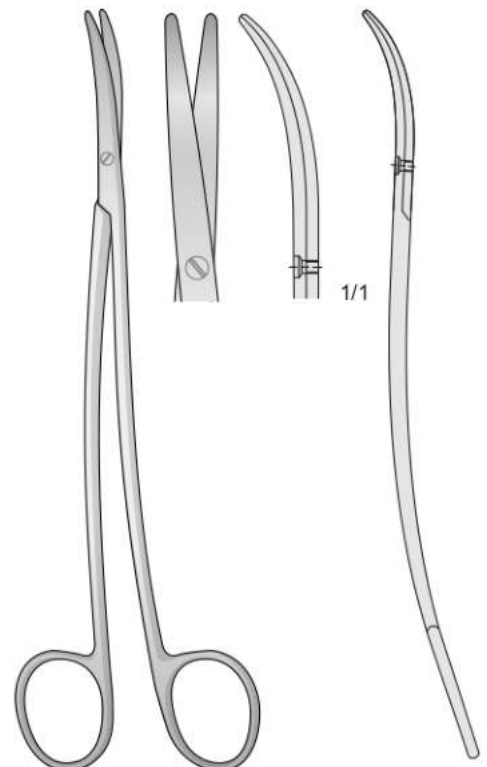


METZENBAUM
ST-10080
200 mm

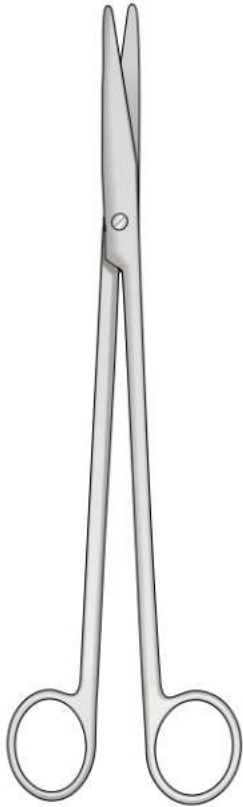


ST-10080-1

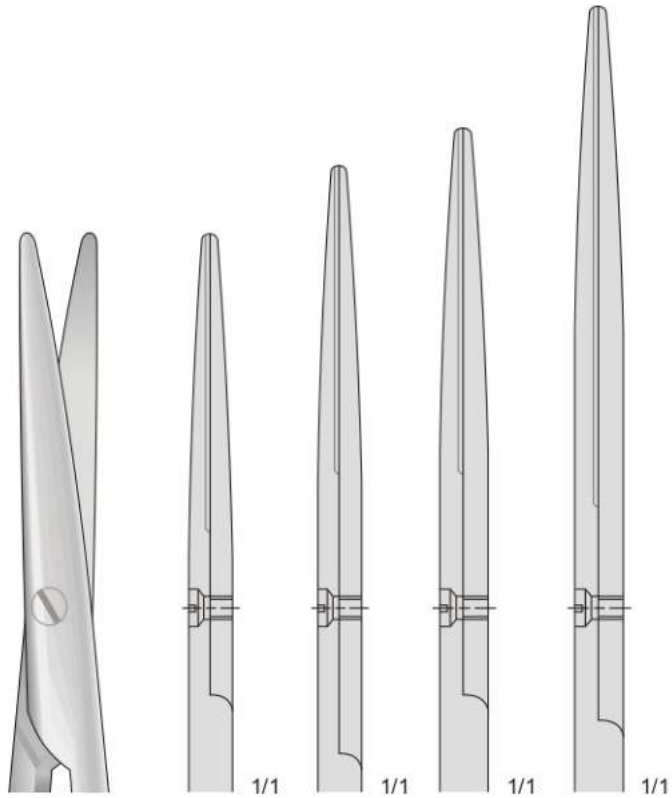
ST-10080-2



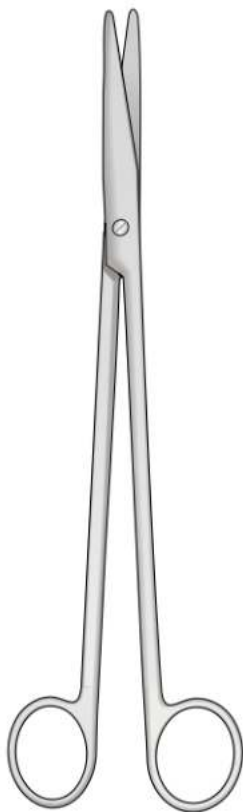
METZENBAUM-FINO
ST-10081-1 - 180 mm
ST-10081-2 - 200 mm
ST-10081-3 - 230 mm



NELSON-METZENBAUM
ST-10082



ST-10082-1 230 mm ST-10082-2 250 mm ST-10082-3 280 mm ST-10082-4 305 mm



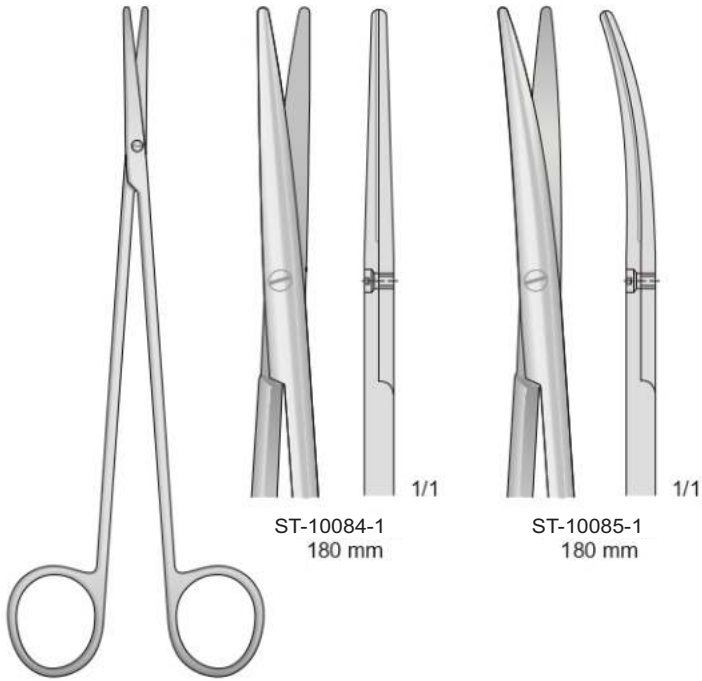
NELSON-METZENBAUM
ST-10083



ST-10083-1 230 mm ST-10083-2 250 mm ST-10083-3 280 mm ST-10083-4 305 mm



Fine - Delicate - Fein - Fins - Finas

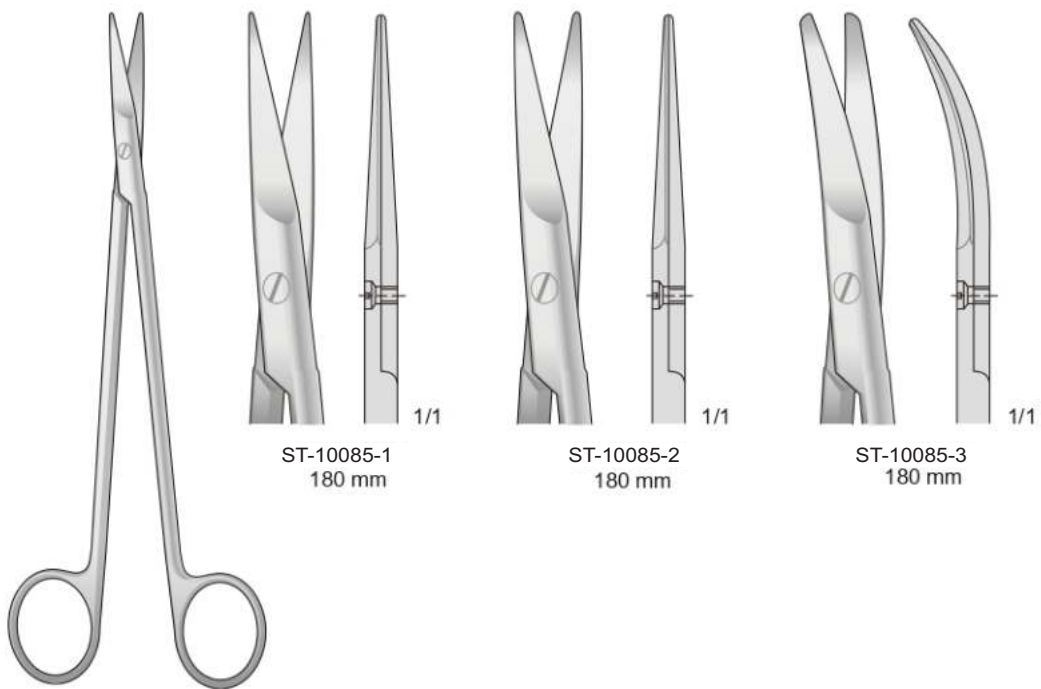


ST-10084-1
180 mm

ST-10085-1
180 mm

TOENNIS-ADSON
ST-10084
180 mm

Fine - Delicate - Fein - Fins - Finas



ST-10085-1
180 mm

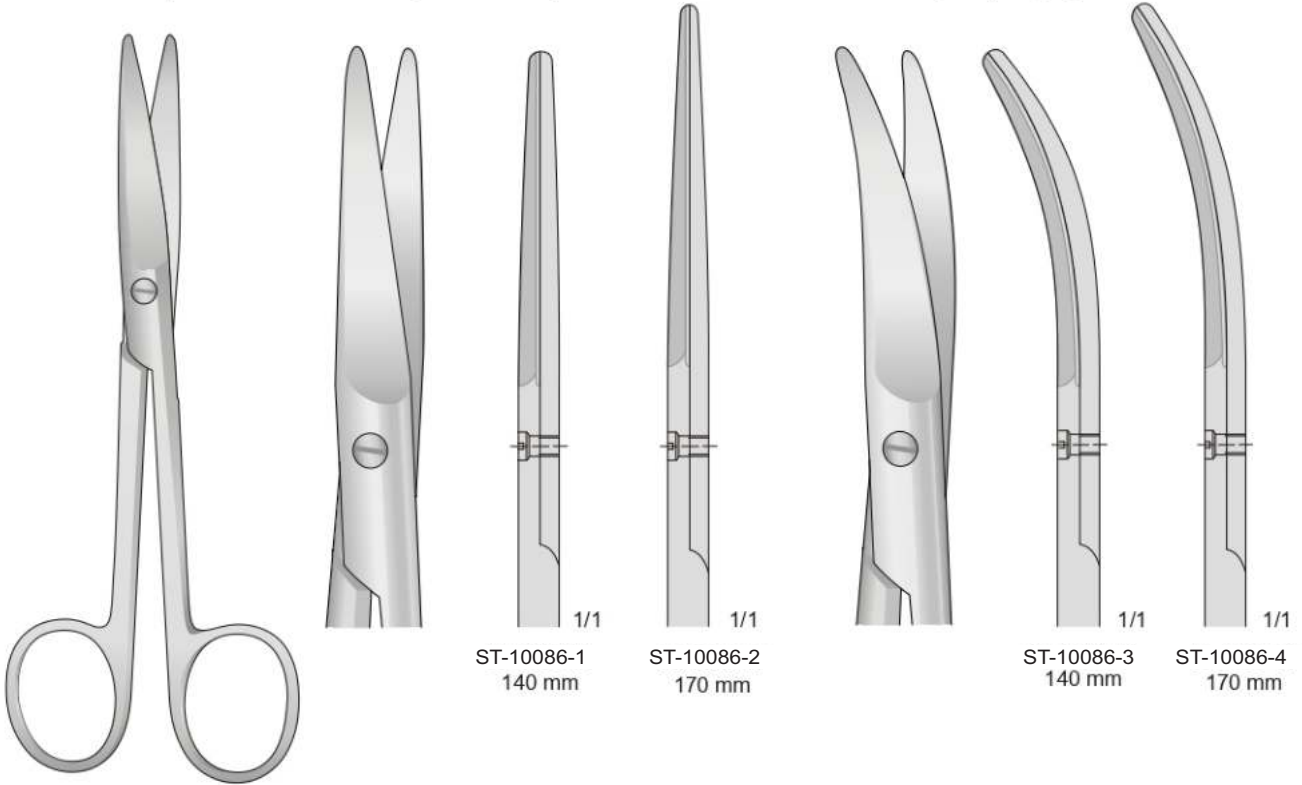
ST-10085-2
180 mm

ST-10085-3
180 mm

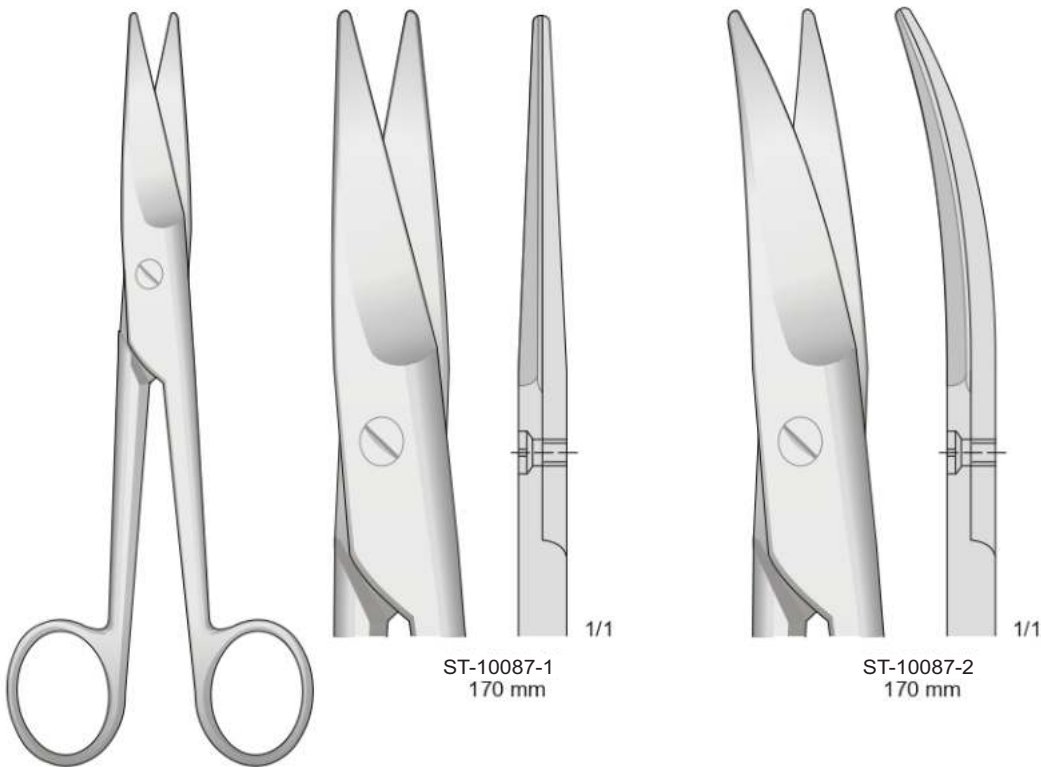
TOENNIS
ST-10085
180 mm



Forbici per dissezione - Dissecting scissors - Präparierscheren - Ciseaux à dissection - Tijeras para preparaciones



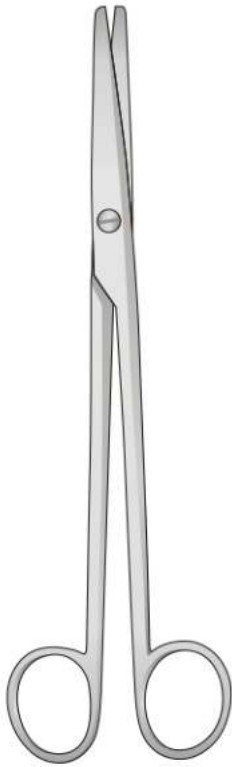
MAYO
ST-10086



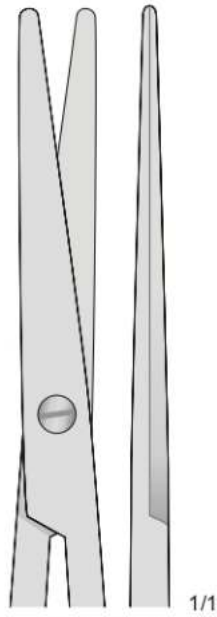
MAYO-NOBLE
ST-10087



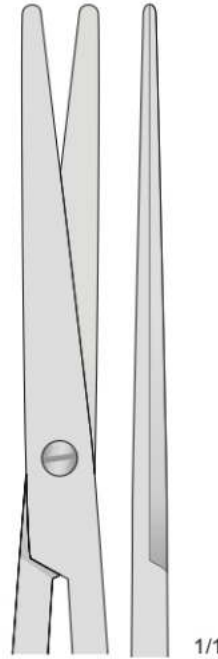
Forbici per dissezione - Dissecting scissors - Präparierscheren - Ciseaux à dissection - Tijeras para preparaciones



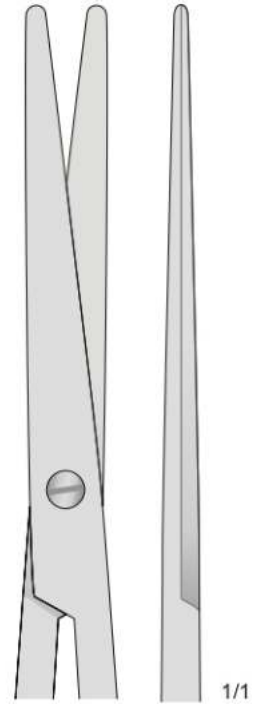
MAYO
ST-10088



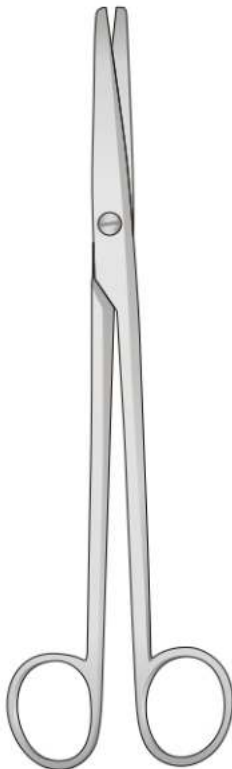
ST-10088-1
160 mm



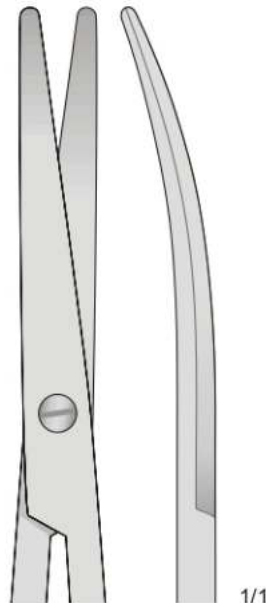
ST-10088-2
190 mm



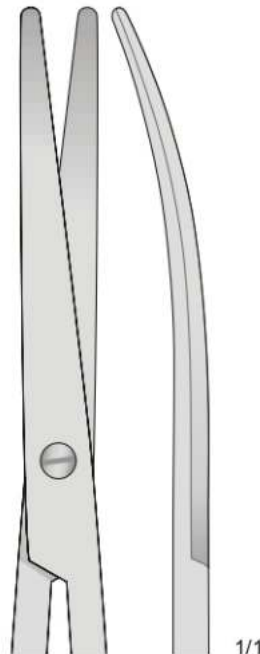
ST-10088-3
210 mm



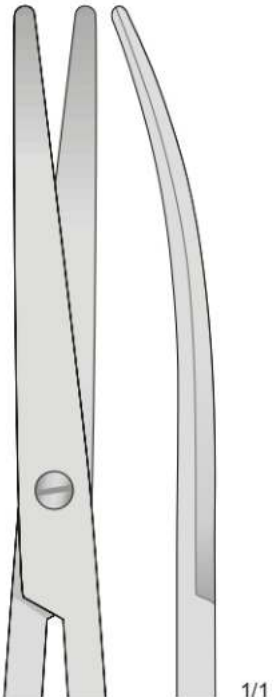
MAYO
ST-10089



ST-10089-1
160 mm

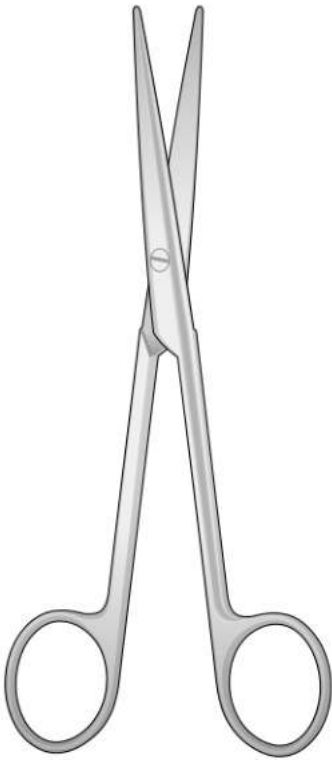


ST-10089-2
190 mm



ST-10089-3
210 mm

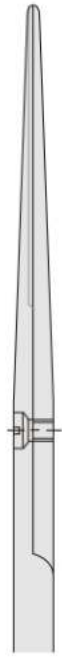
Fine - Delicate - Fein - Fins - Finas



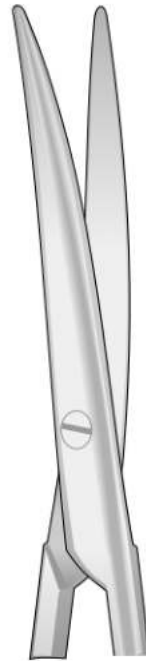
LEXER
ST-10090
165 mm



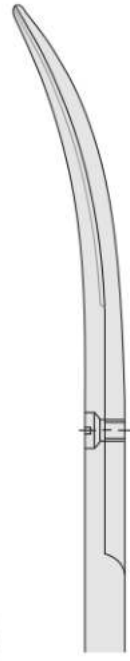
ST-10090-1



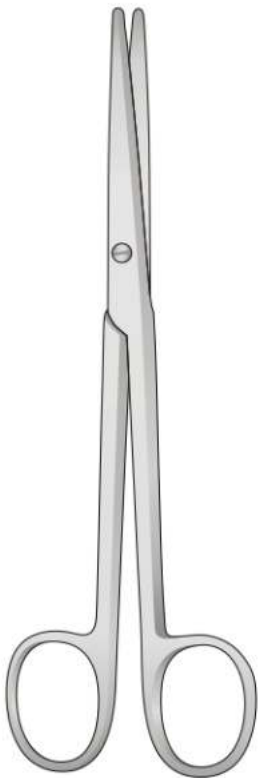
1/1



ST-10090-2



1/1



LEXER
ST-10091



ST-10091-1
160 mm

1/1



ST-10091-2
210 mm

1/1



ST-10091-3
160 mm

1/1

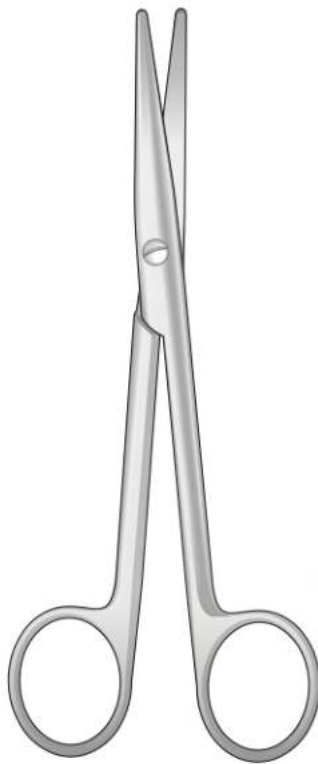


ST-10091-4
210 mm

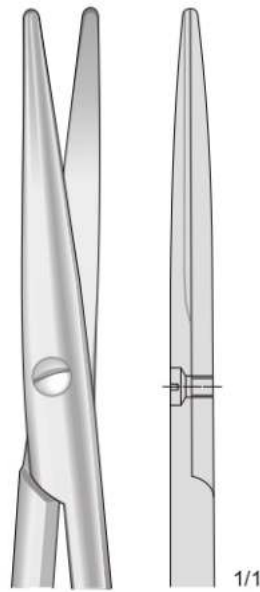
1/1



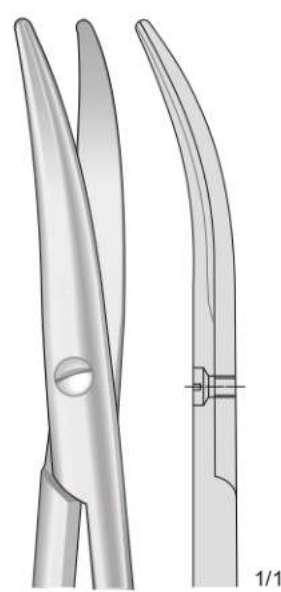
Forbici per dissezione - Dissecting Scissors - Präparirenscheren - Ciseaux à dissection - Tijeras para preparaciones



STILLE
ST-10092
150 mm

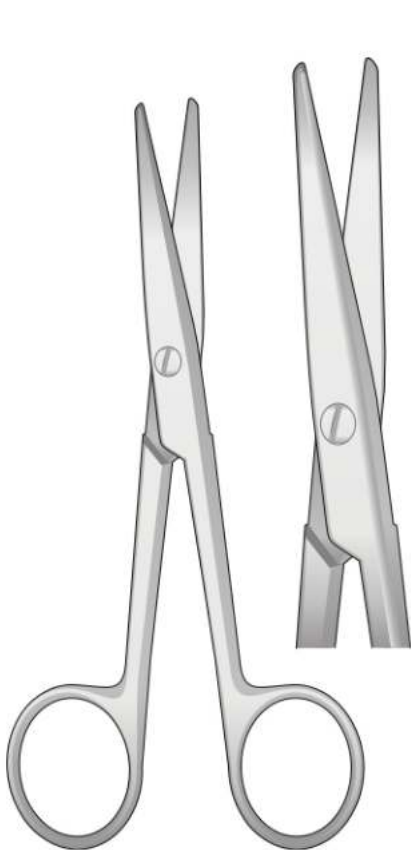


ST-10092-1
150 mm

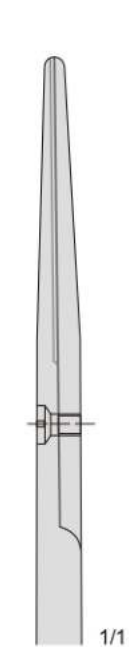


ST-10092-2
150 mm

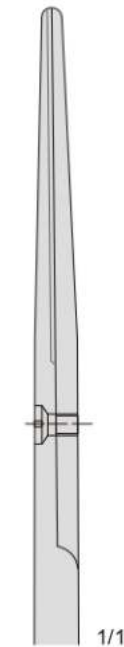
ST-10092



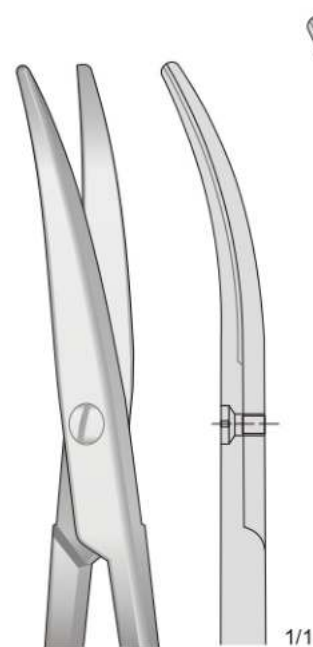
MAYO-STILLE
ST-10093



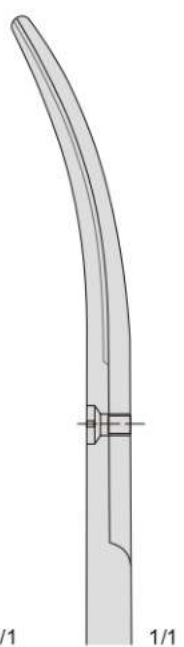
ST-10093-1
140 mm



ST-10093-2
170 mm

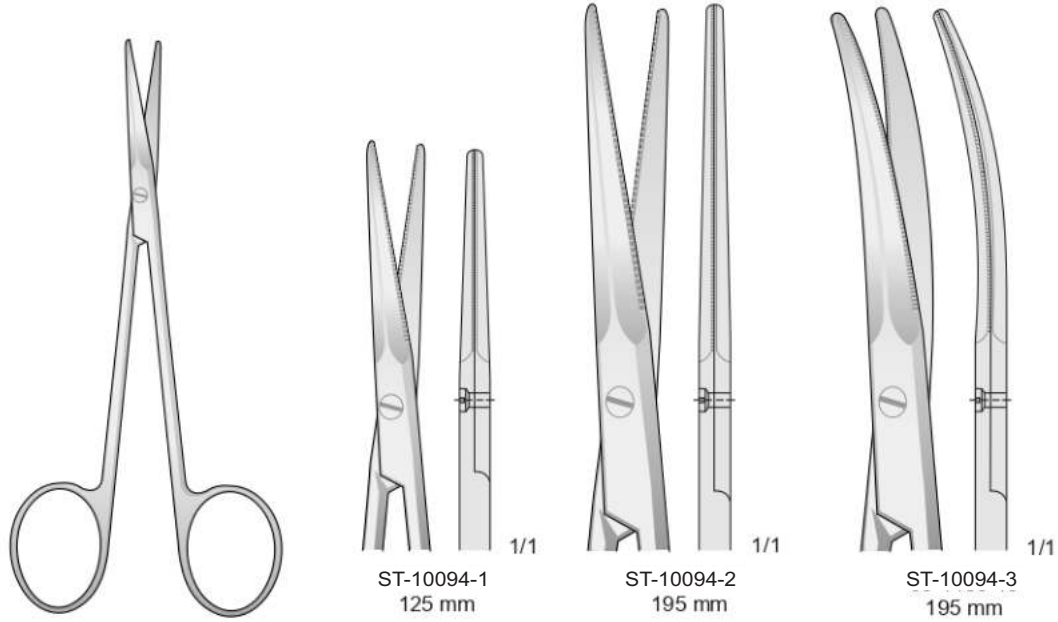


ST-10093-3
140 mm

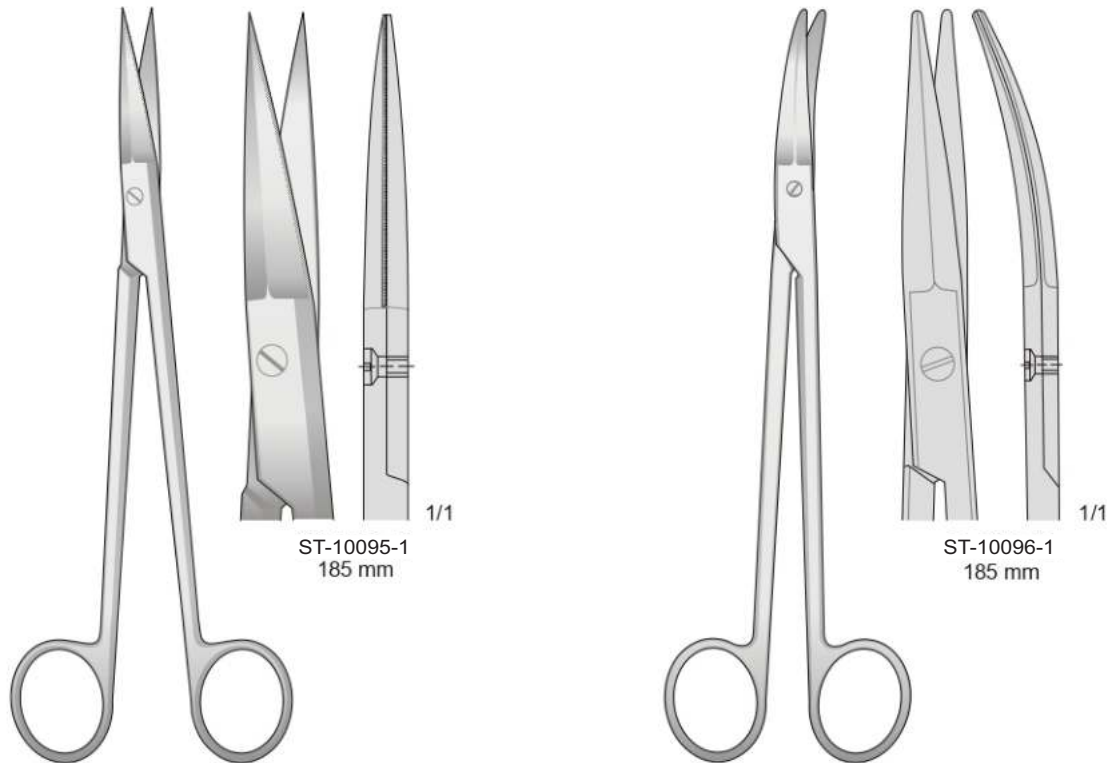


ST-10093-4
170 mm

Forbici per dissezione a taglio bilaterale - Bilateral Dissecting Scissors
Präparierscheren - Ciseaux à dissection - Tijeras para preparaciones

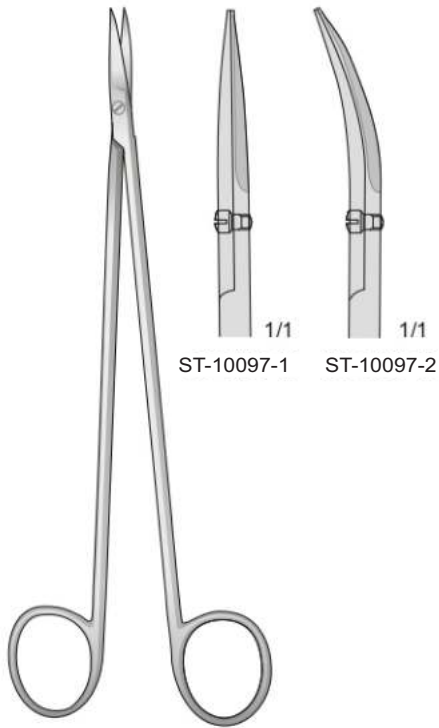


GORNEY
ST-10094

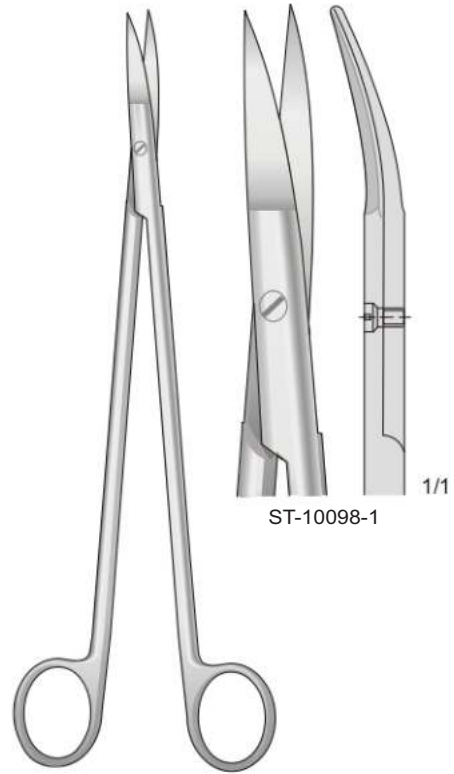


ST-10095
185 mm

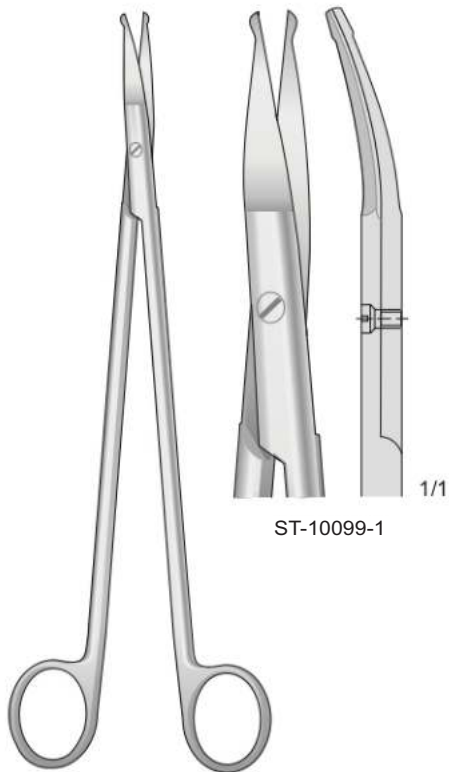
ST-10096
185 mm



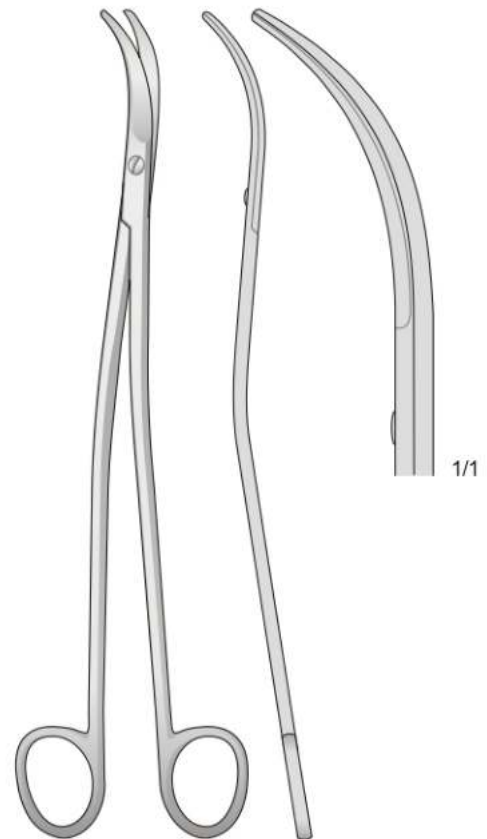
ST-10097
190 mm



STRULLY
ST-10098
220 mm



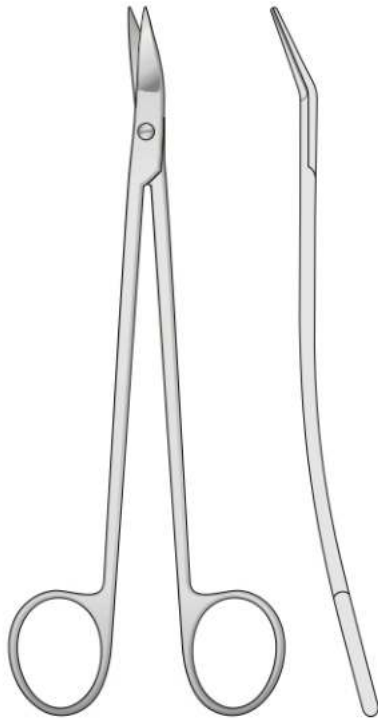
STRULLY
ST-10099
220 mm



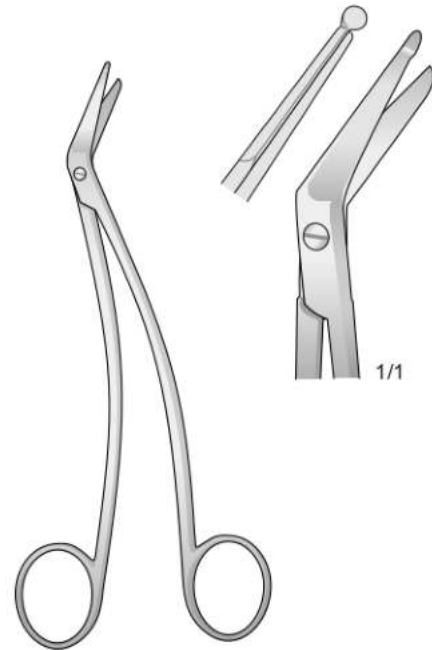
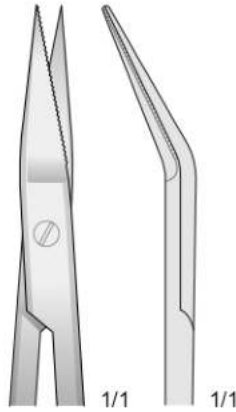
SATINSKY
ST-10100
245 mm



Dentellata - Serrated - Gezahnt - Dentelé - Dentadas

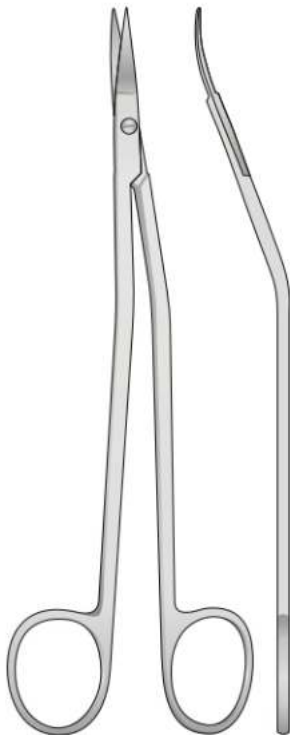


DEAN
ST-10101
180 mm

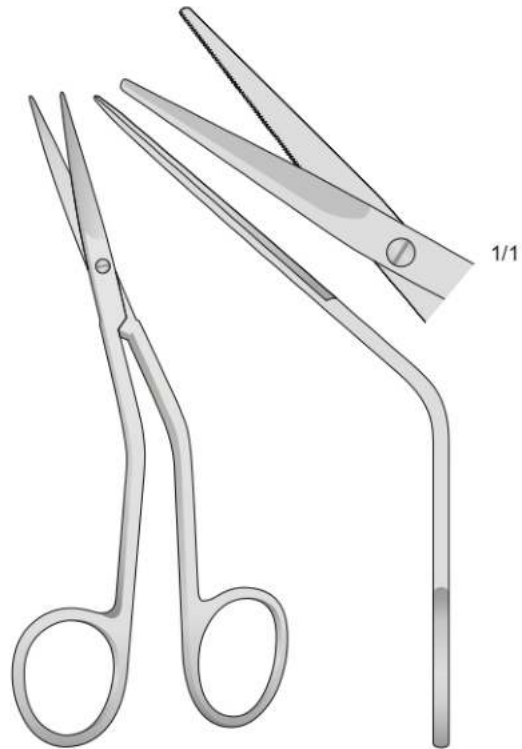


SCHMIEDEN-TAYLOR
ST-10102
155 mm

Dentellata - Serrated - Gezahnt - Dentelé - Dentadas



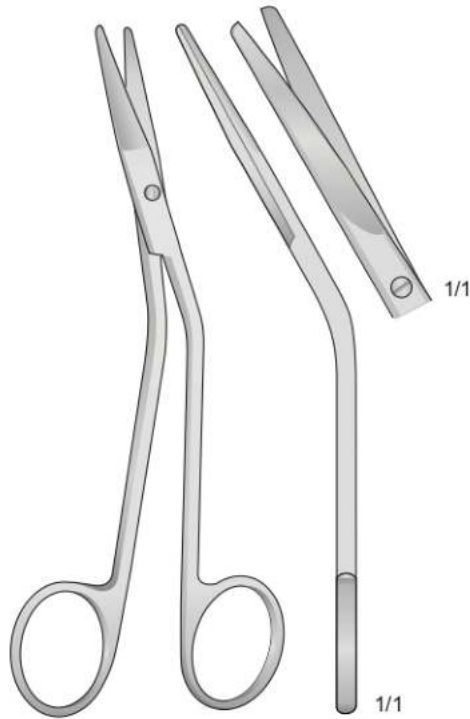
DANDY
ST-10103
175 mm



FOMON
ST-10104
135 mm



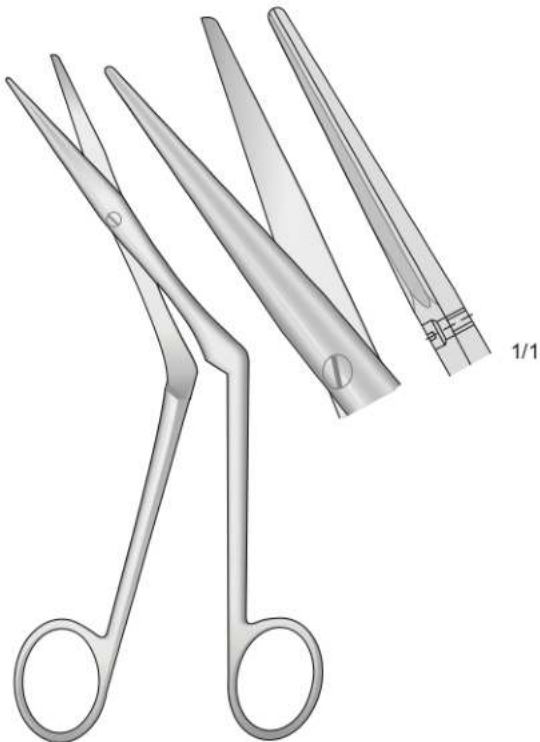
Forbici nasali - Nasal Scissors - Nasenscheren - Ciseaux nasaux - Tijeras nasales



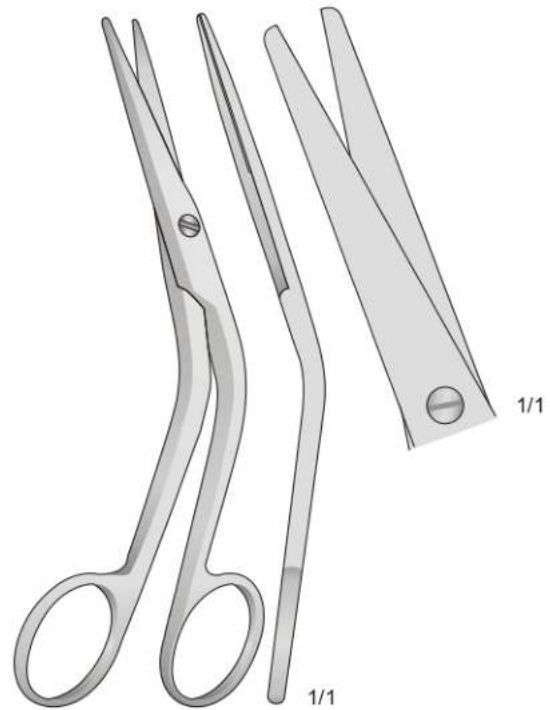
FOMON
ST-10105
150 mm



HEYMANN
ST-10106
180 mm



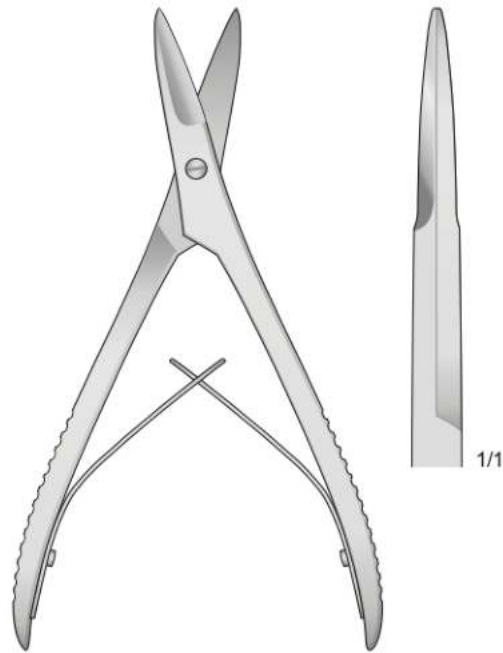
HEYMANN-KNIGHT
ST-10107
175 mm



COTTLE
ST-10108
160 mm



ST-10109
195 mm



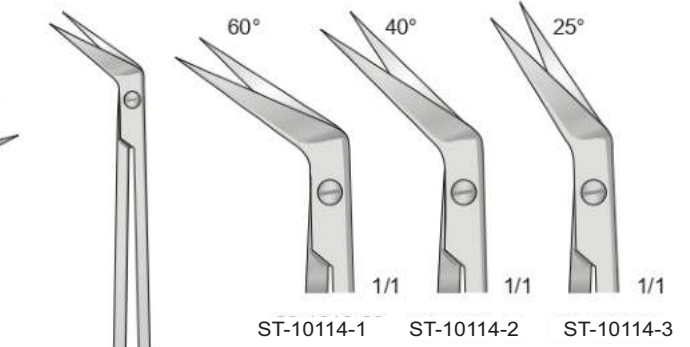
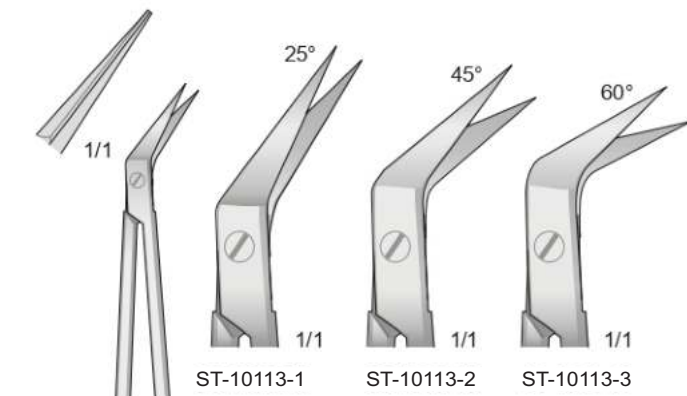
ST-10110
160 mm



ST-10111
230 mm



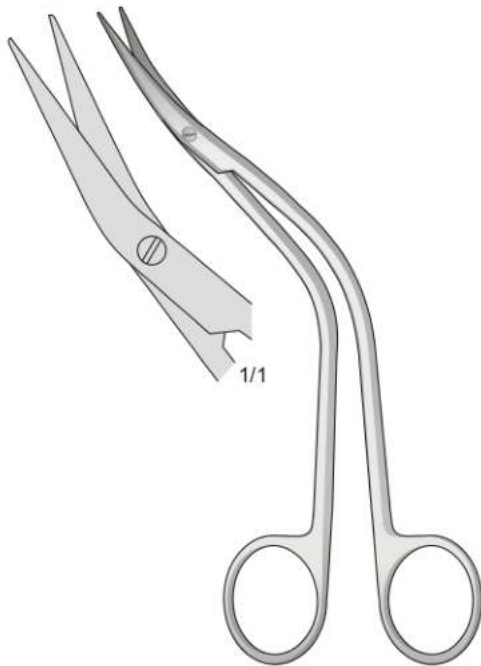
KILLIAN
ST-10112
210 mm



DE BAKEY (POTTS-SMITH)
ST-10113
160 mm

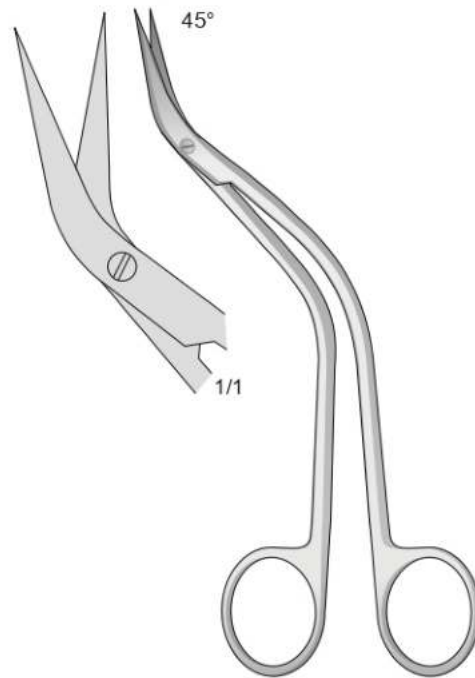
POTTS-SMITH
ST-10114
190 mm

Smussa - Blunt - Stumpf
Mousse - Romas

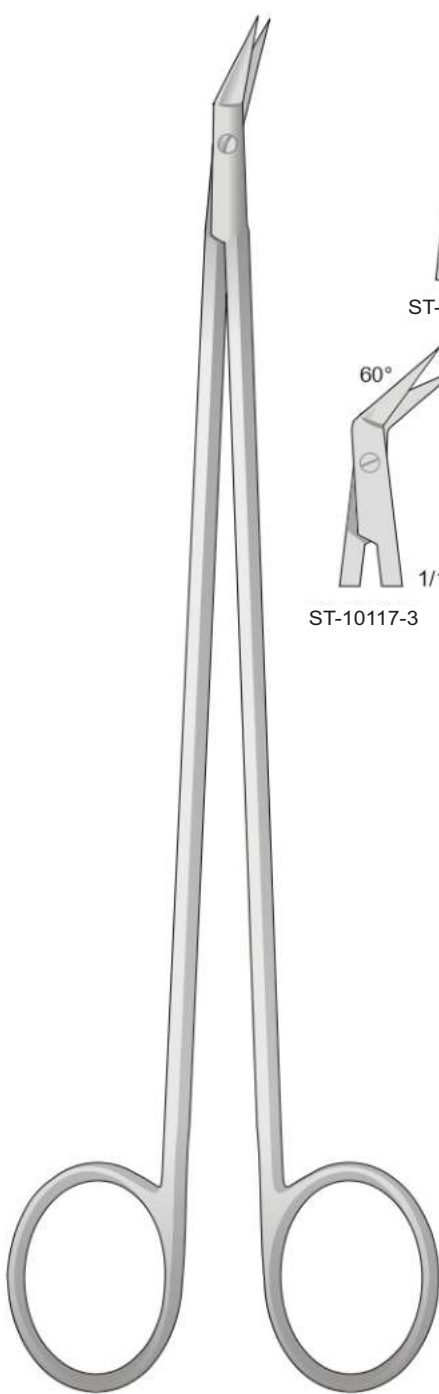


DE BAKEY
ST-10115
155 mm

Acuta - Sharp - Spitz
Pointu - Agudas



DE BAKEY
ST-10116
155 mm



DIETRICH
ST-10117
190 mm



ST-10117-1



ST-10117-2



ST-10118-1



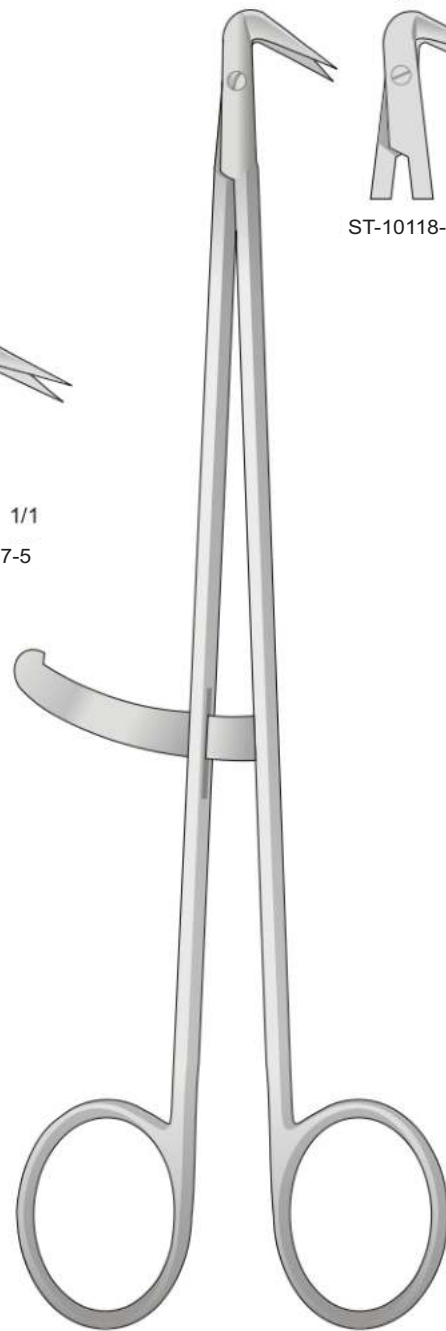
ST-10117-3



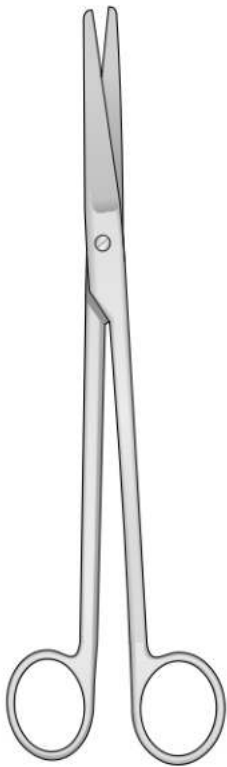
ST-10117-4



ST-10117-5



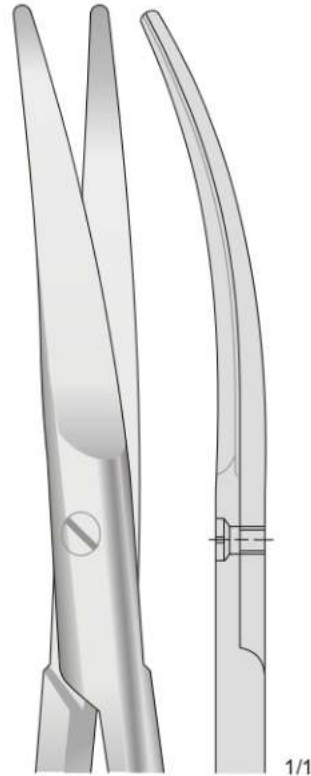
DIETRICH
ST-10118
190 mm



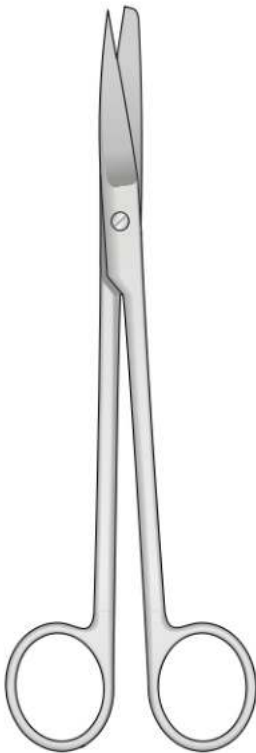
MAYO-HARRINGTON
ST-10119
230 mm



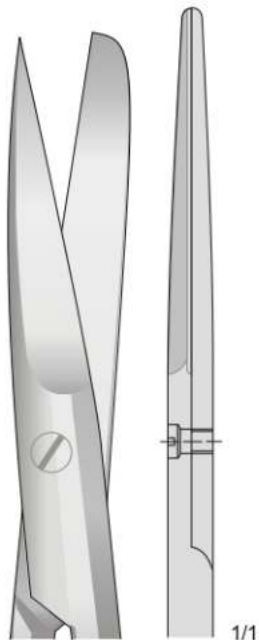
ST-10119-1
230 mm



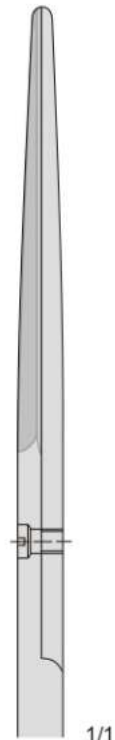
ST-10119-2
230 mm



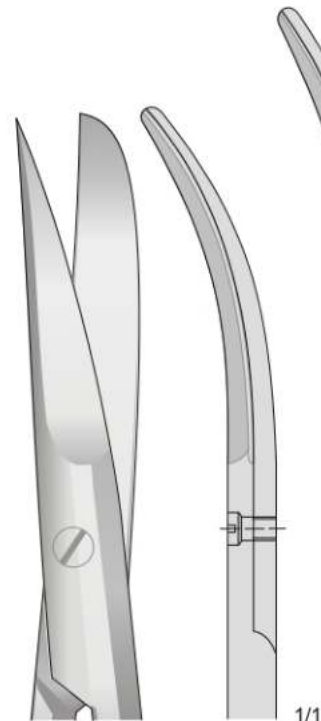
SIMS
ST-10120



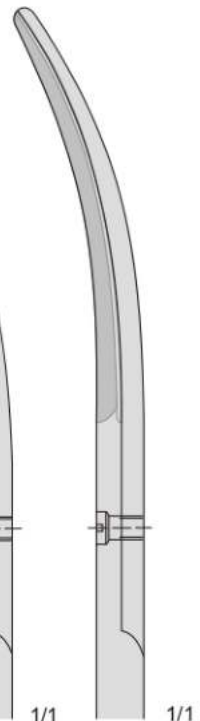
ST-10120-1
200 mm



ST-10120-2
230 mm

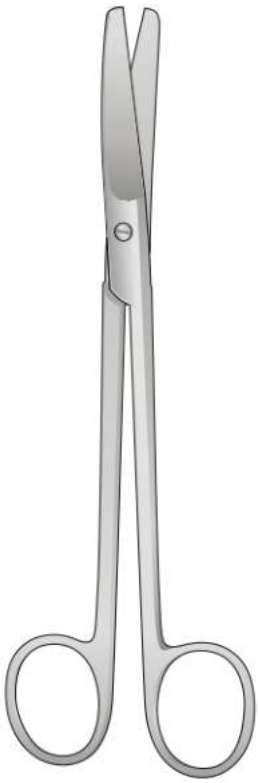


ST-10120-3
200 mm



ST-10120-4
230 mm

Punte smusse

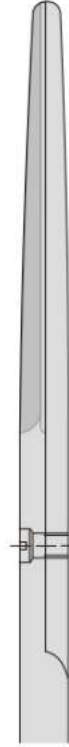


SIMS
ST-10121



ST-10121-1
200 mm

1/1



ST-10121-2
230 mm

1/1



ST-10121-3
200 mm

1/1



ST-10121-4
230 mm

1/1



SIMS
ST-10122
200 mm



ST-10122-1
200 mm

1/1



SIMS
ST-10123
210 mm



ST-10123-1
210 mm

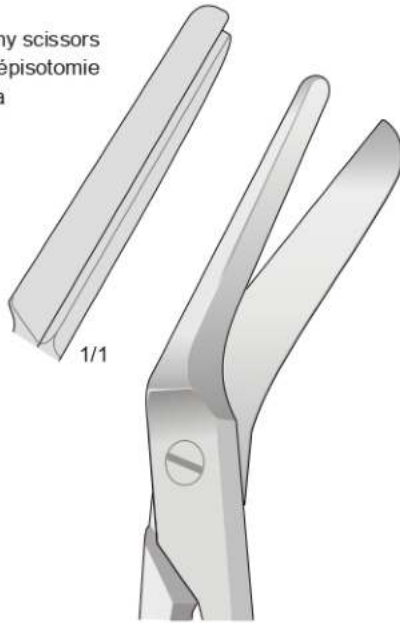
1/1



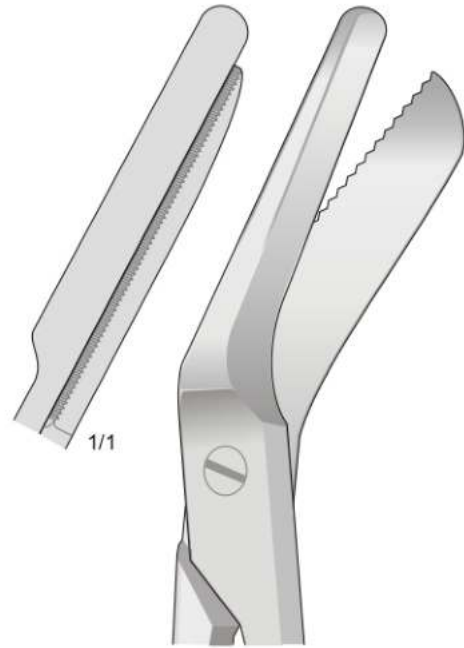
Forbici per episiotomia - Episiotomy scissors
Episiotomie-Scheren - Ciseaux à épisiotomie
Tijeras para episiotomia



BRAUN-STADLER
ST-10124

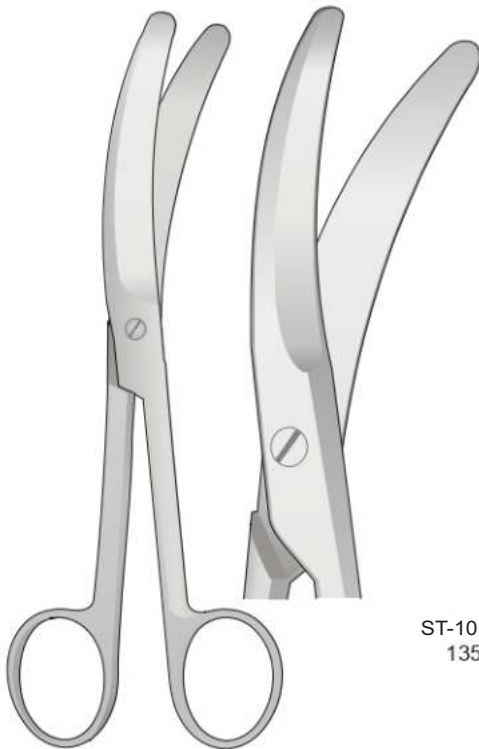


ST-10124-1
145 mm

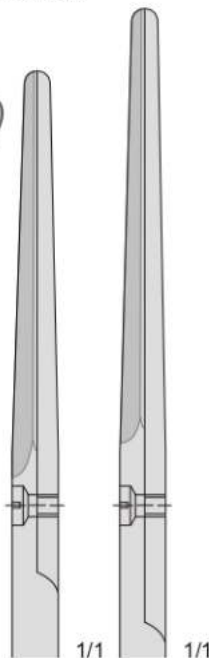


ST-10125
200 mm

Forbici per cordone ombelicale - Umbilical cord scissors
Nabelschnur Scheren - Ciseaux à cordon ombilical
Tijeras umbilicales



ST-10126

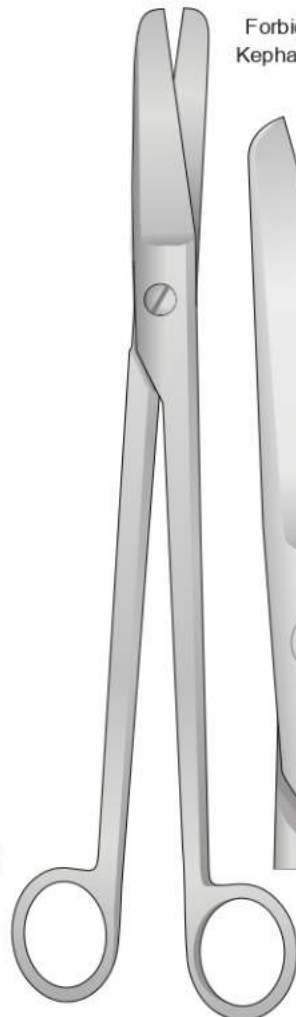


ST-10126-1
135 mm

1/1

ST-10126-2
160 mm

1/1



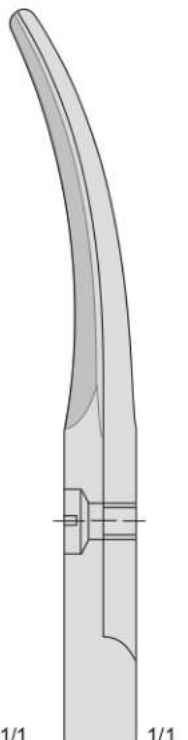
DUBOIS
ST-10127

Forbici per cefalotomia - Cephalotomy scissors
Kephalotomie Scheren - Ciseaux à cèphalotomie
Tijeras para cefalotomia



ST-10127-1
270 mm

1/1

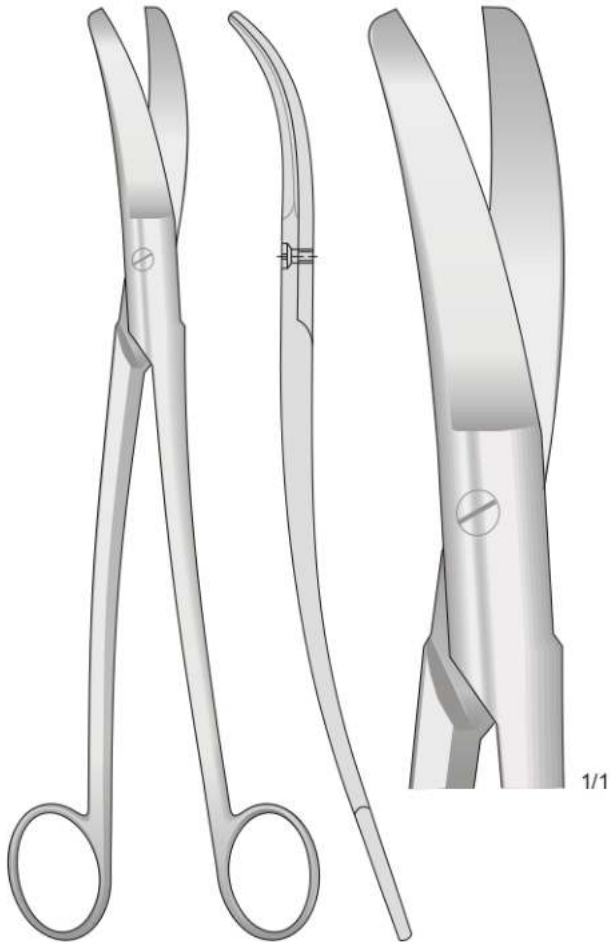


ST-10127-2
270 mm

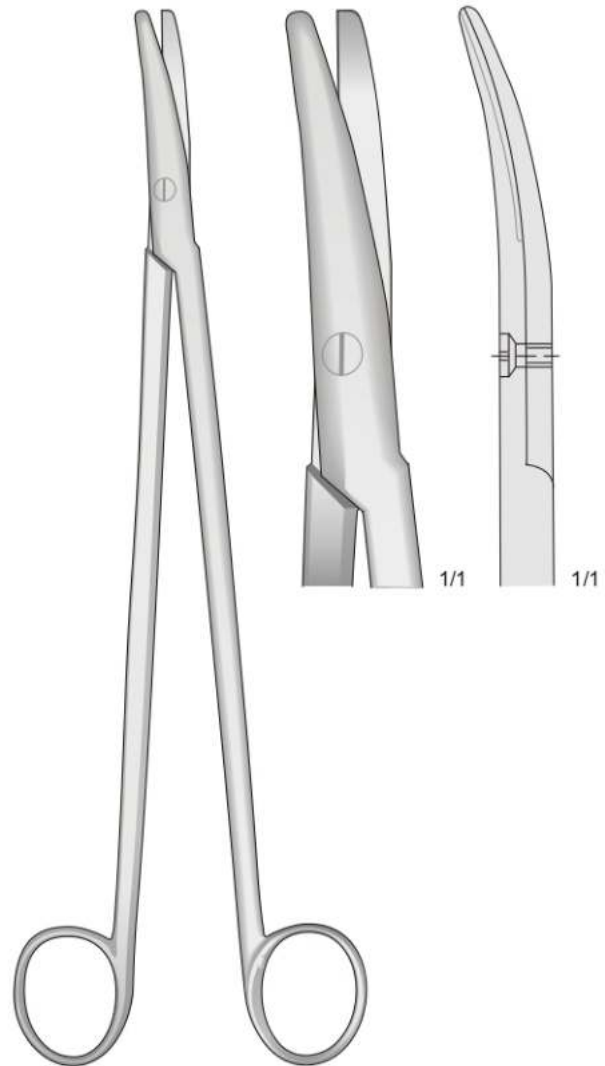
1/1



Forbici per utero
Uterine scissors
Uterusschere
Ciseaux utérins
Tijeras para útero



SIEBOLD
ST-10128
245 mm



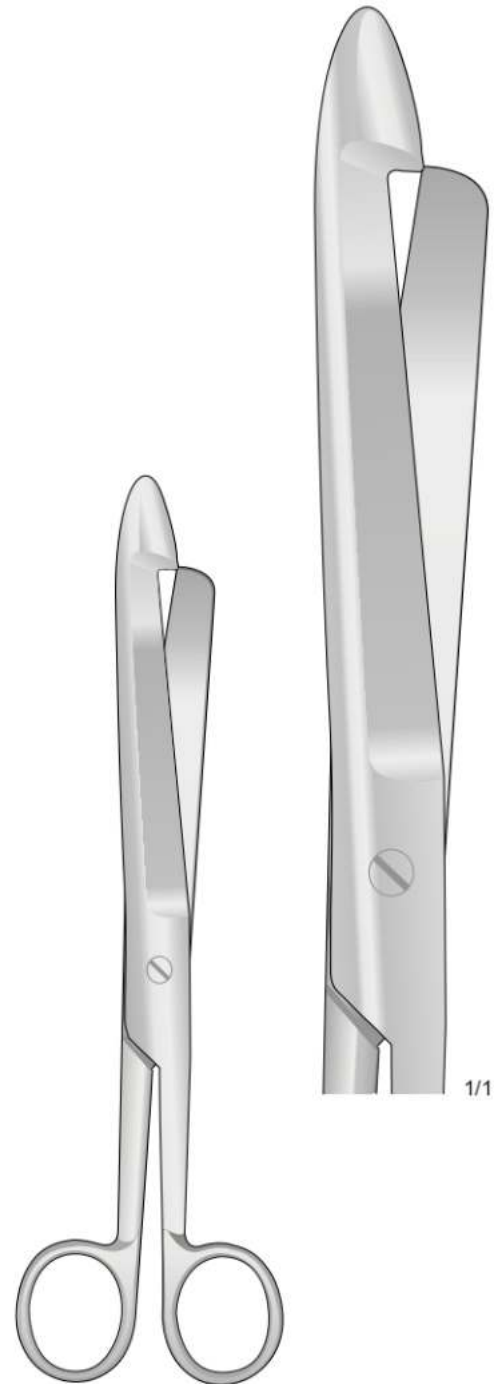
WELLER
ST-10129
280 mm

Forbici per Episiotomia
Episiotomy Scissors
Episiotomie-Scheren
Ciseaux à épisiotomie
Tijeras para Episiotomia



WALDMANN
ST-10130
180 mm

Forbici per Enterotomia
Bowel Scissors
Darmscheren
Ciseaux-Entérotomes
Enterótomos

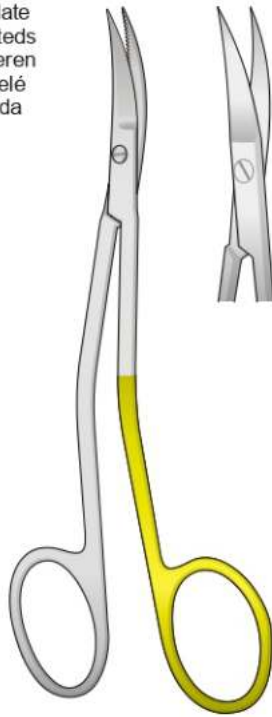


ST-10131
210 mm



Forbici "super-cut" estremamente taglienti per tessuti con riduzione del trauma - "Super-cut" scissors for gripping tissue and cutting interproximally
 "Super-cut" scheren micro-schliff für tissue atrauma - Ciseaux "super cut" coupe les tissus en reduisant les risques de traumatisme
 Tijeras "super cortes" para cortar tissue-atrauma

Forbici Dentellate
 Scissors Serrated
 Gezahnte Scheren
 Ciseaux Dentelé
 Tijeras Dentada



LA GRANGE
 ST-10131
 115 mm



1/1

Acute
 Sharp
 Spitz
 Pointu
 Agudas

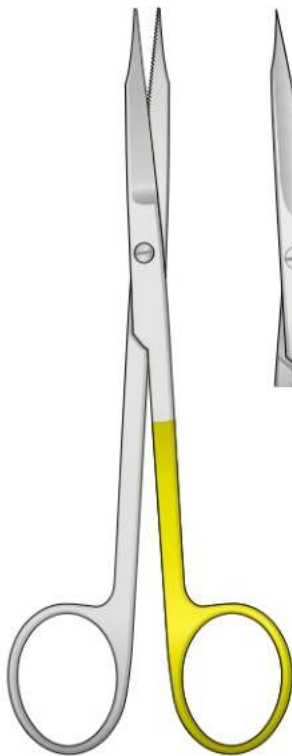


LA GRANGE
 ST-10131-1

Smusse
 Blunt
 Stumpf
 Mousse
 Romas



LA GRANGE
 ST-10131-2



GOLDMAN-FOX
 ST-10132
 135 mm



1/1

ST-10132-1

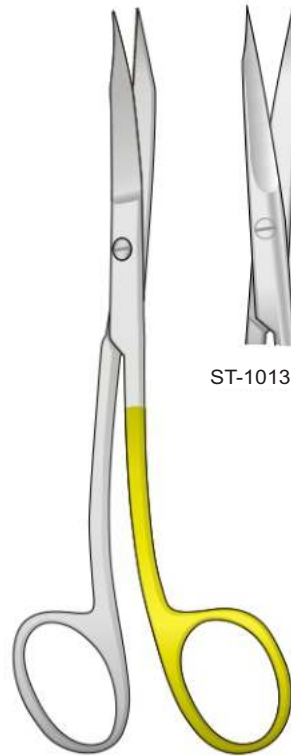


1/1



1/1

ST-10132-2



GOLDMAN-FOX S FORM
 ST-10133
 130 mm

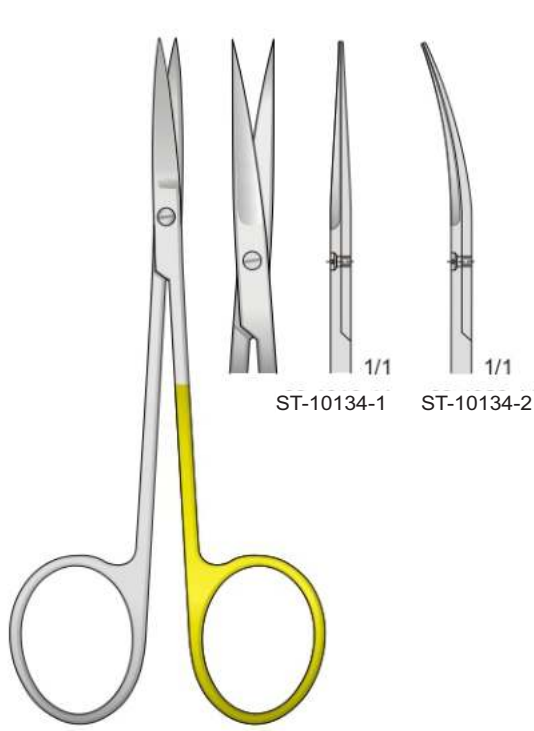


1/1

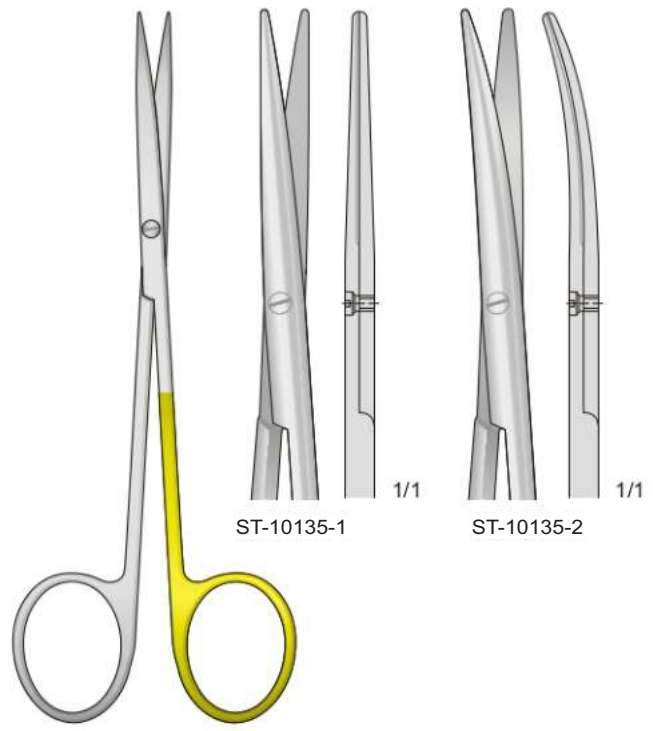
ST-10133-1



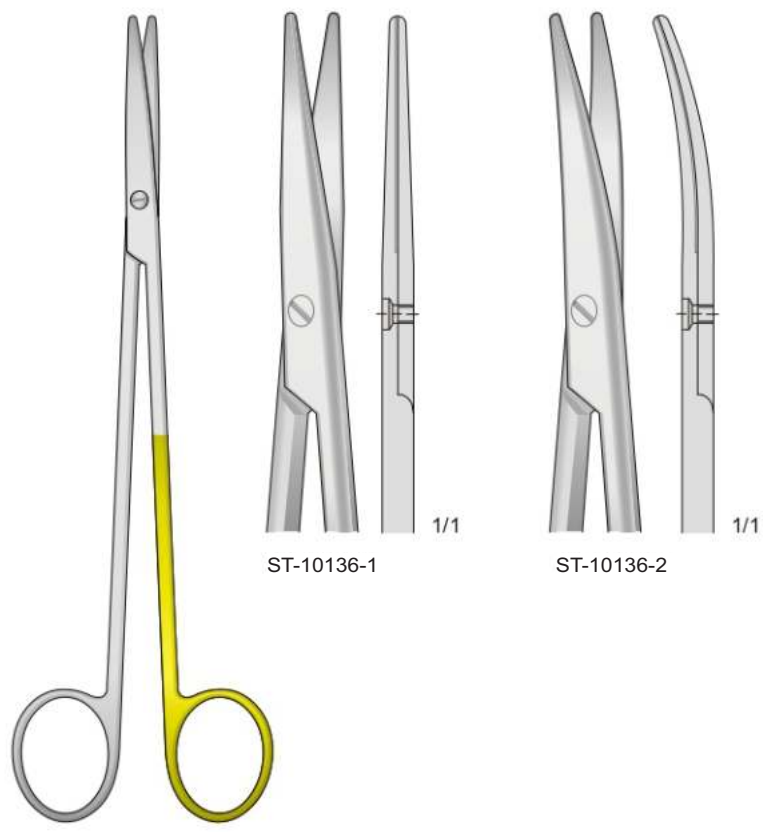
Forbici "super-cut" estremamente taglienti per tessuti con riduzione del trauma - "Super-cut" scissors for gripping tissue and cutting interproximally
 "Super-cut" scheren micro-schliff für tissue atrauma - Ciseaux "super cut" coupe les tissus en reduisant les risques de traumatisme
 Tijeras "super cortes" para cortar tissute-atrauma



IRIS
ST-10134
110 mm



METZENBAUM
ST-10135
145 mm



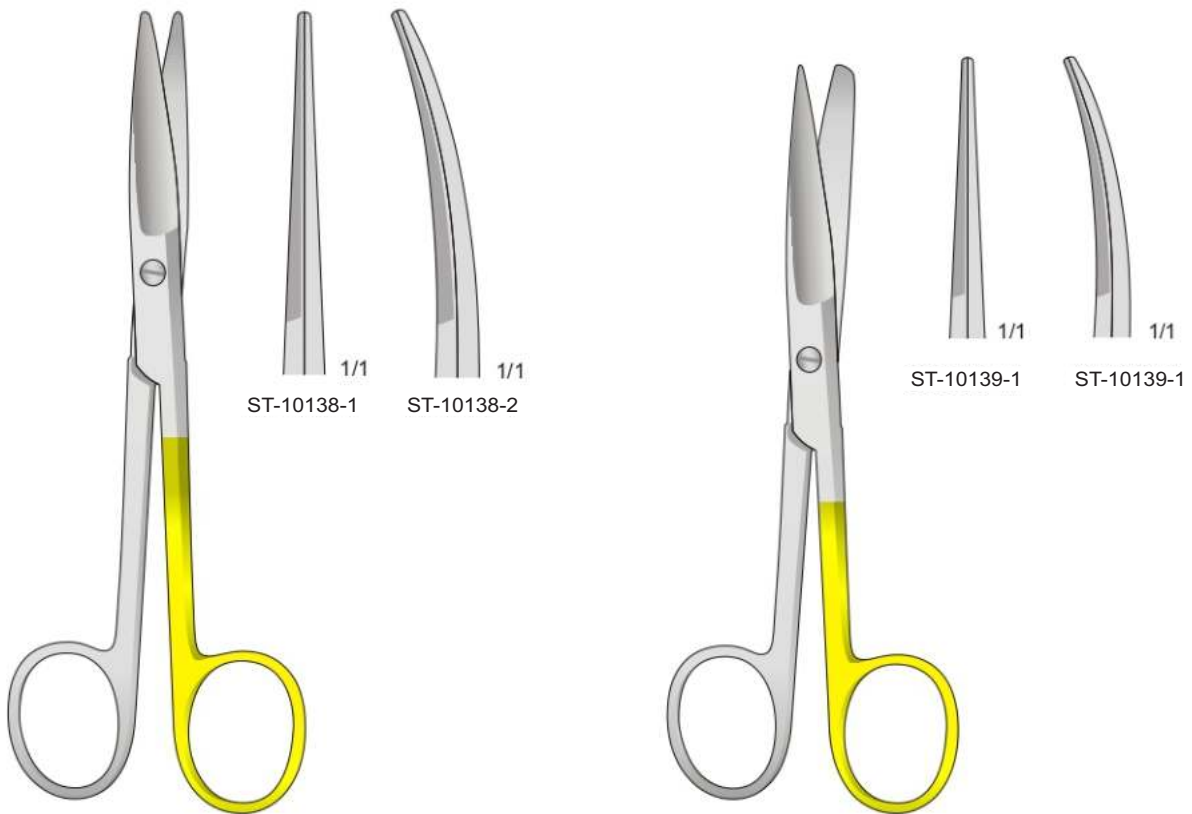
METZENBAUM
ST-10136
185 mm



Forbici "super-cut" estremamente taglienti per tessuti con riduzione del trauma - "Super-cut" scissors for gripping tissue and cutting interproximally
"Super-cut" scheren micro-schliff für tissue atrauma - Ciseaux "super cut" coupe les tissus en reduisant les risques de traumatisme
Tijeras "super cortes" para cortar tissue-atrauma



MAYO
ST-10137
140 mm

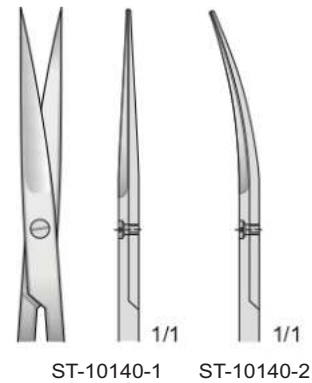
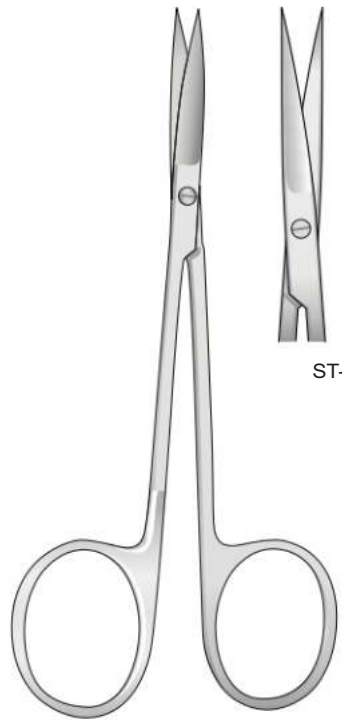


MAYO
ST-10138
170 mm

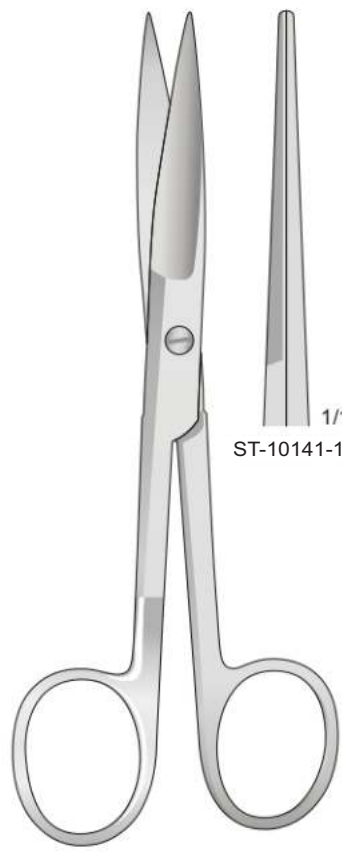
ST-10139
145 mm



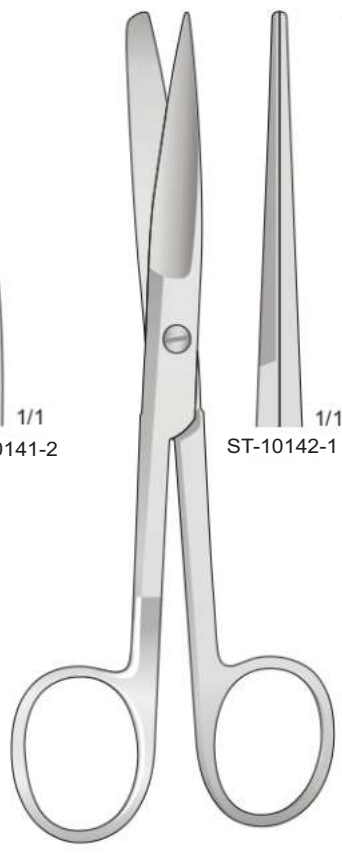
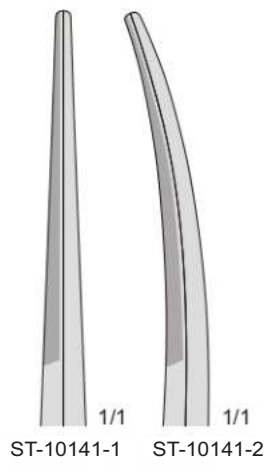
L = mancini
left
links
gauche
izquierdo



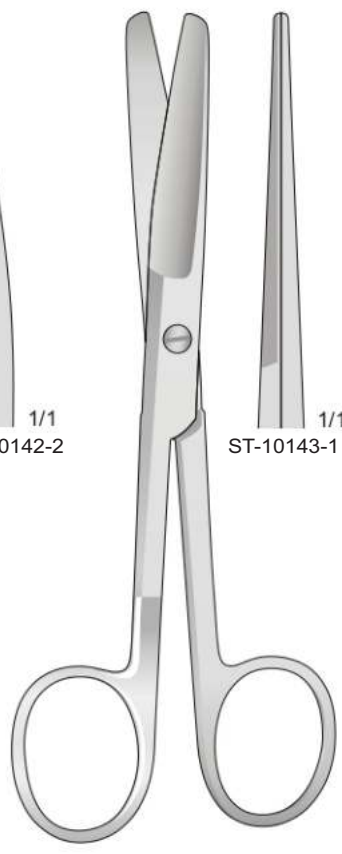
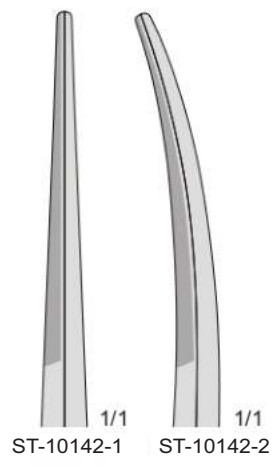
IRIS
ST-10140
110 mm



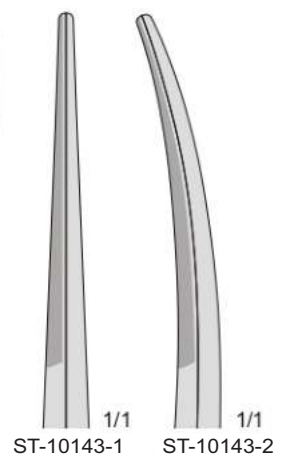
ST-10141
145 mm



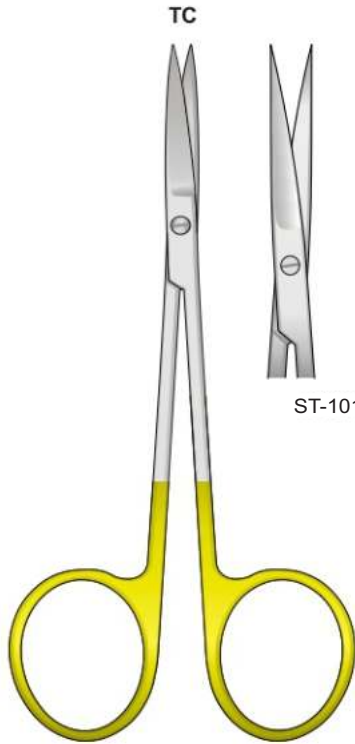
ST-10142
145 mm



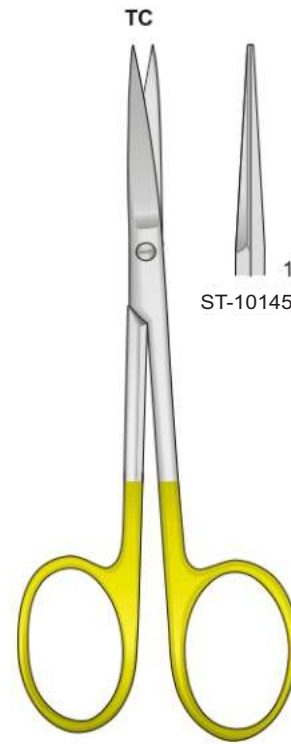
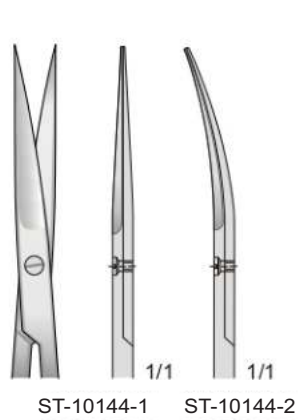
ST-10143
145 mm



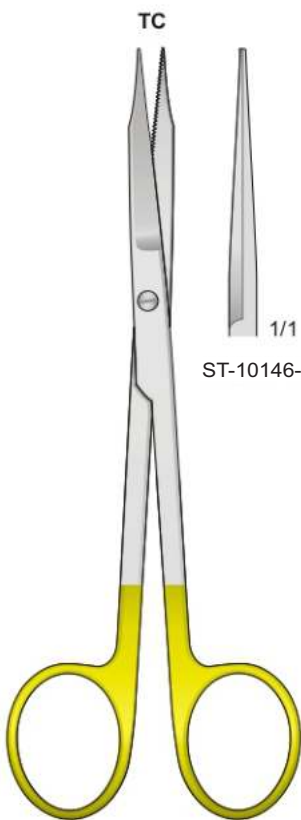
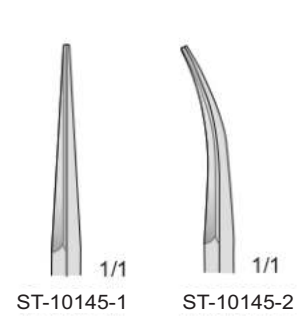
Con punta al carburo di tungsteno - Tungsten-carbide scissors
Mit Hartmetalleinsätzen - Avec plaquettes en carbure de tungstène - Tijeras de tungsteno



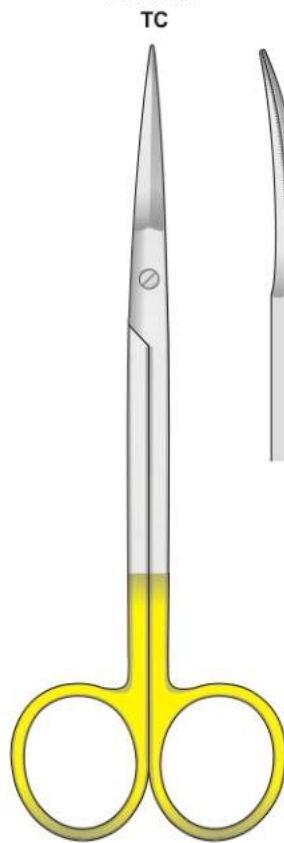
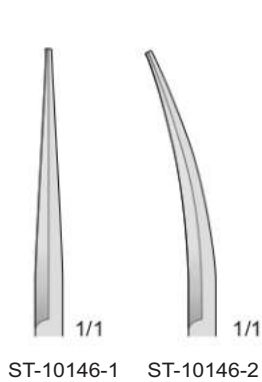
IRIS
ST-10144
115 mm



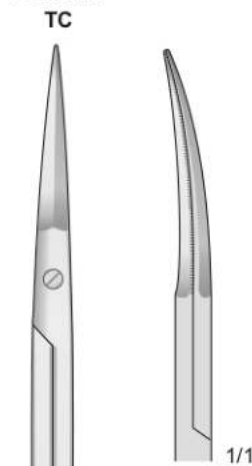
ST-10145
110 mm



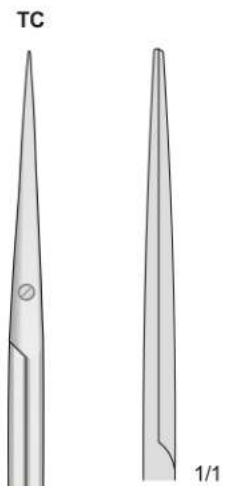
GOLDMAN-FOX
ST-10146
135 mm



PECK-JOSEPH
ST-10147
140 mm

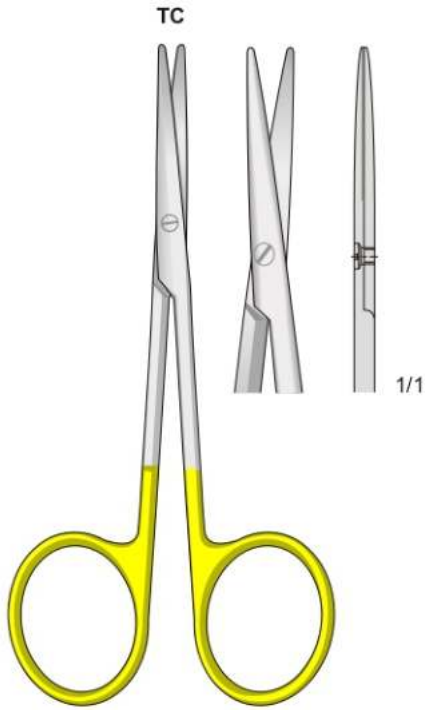


METZENBAUM-FINO
ST-10148
140 mm

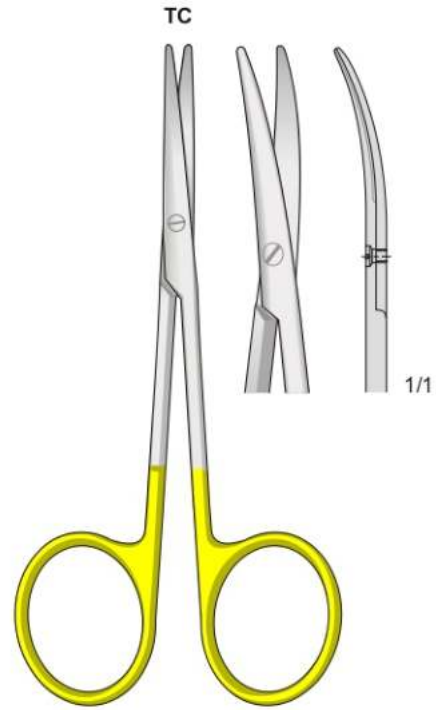




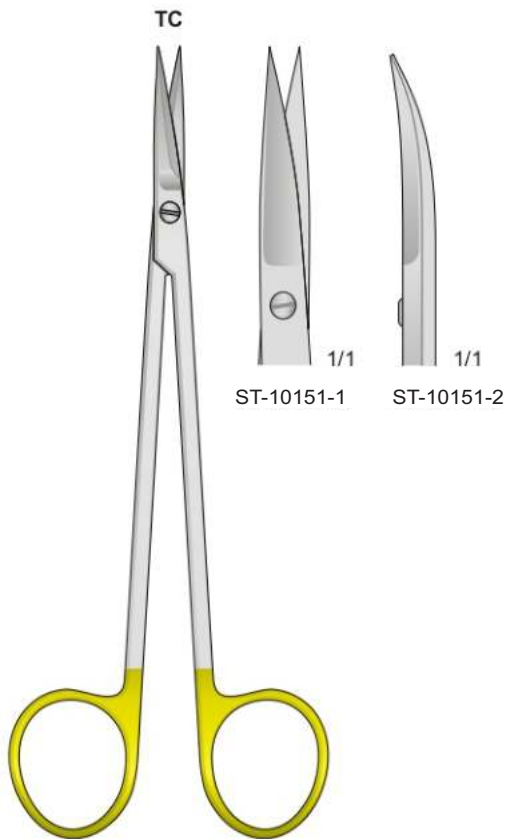
Con punta al carburo di tungsteno - Tungsten-carbide scissors
Mit Hartmetalleinsätzen - Avec plaquettes en carbure de tungstène - Tijeras de tungsteno



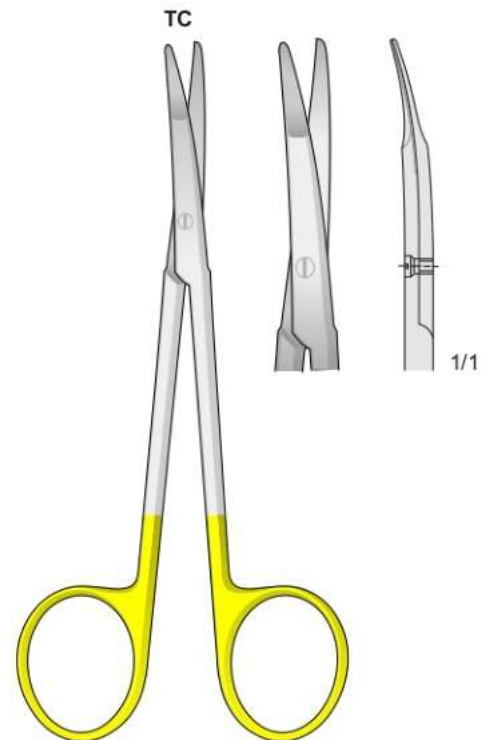
ST-10149
115 mm



ST-10150
115 mm



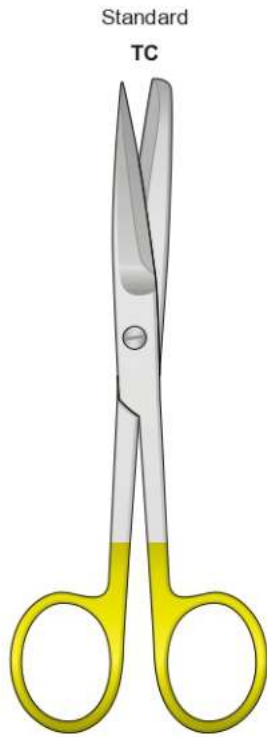
KELLY
ST-10151
160 mm



KILNER (RAGNELL)
ST-10152
125 mm

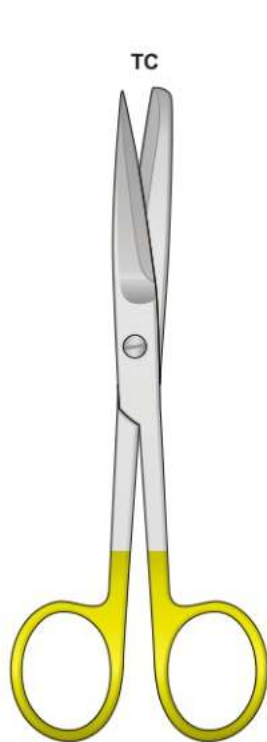
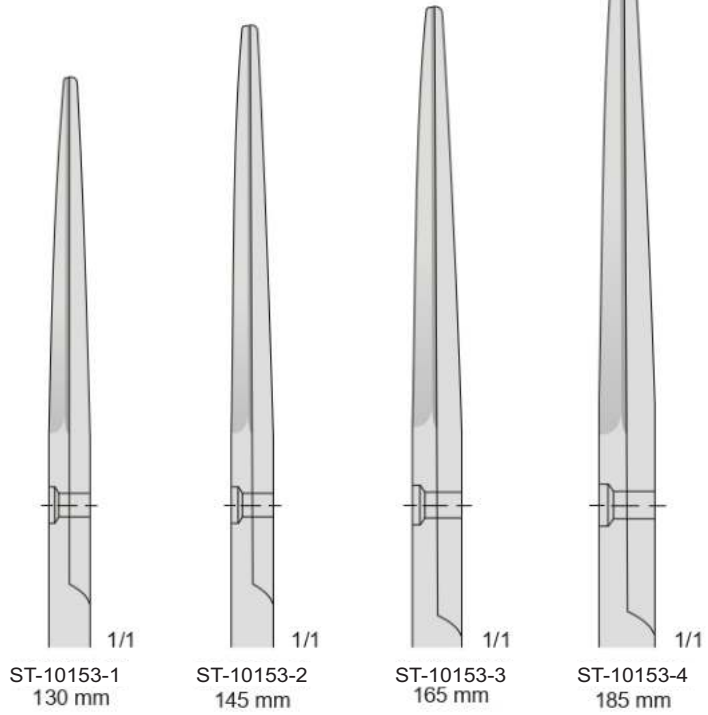


Con punta al carburo di tungsteno - Tungsten-carbide scissors
Mit Hartmetalleinsätzen - Avec plaquettes en carbure de tungstène - Tijeras de tungsteno



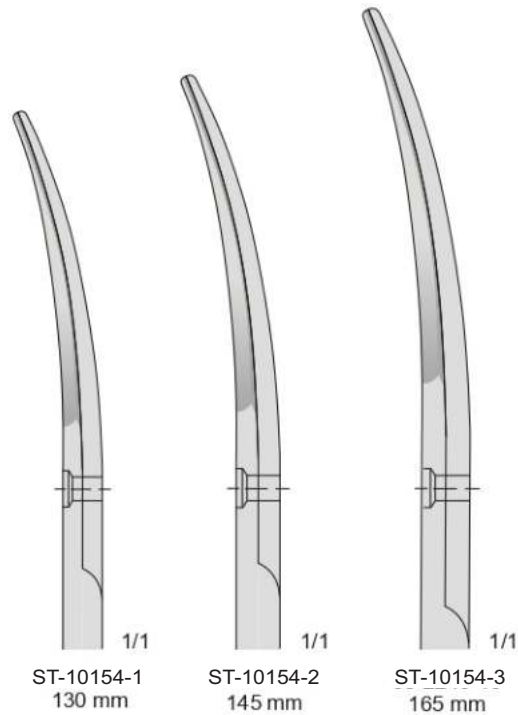
ST-10153

Standard
TC



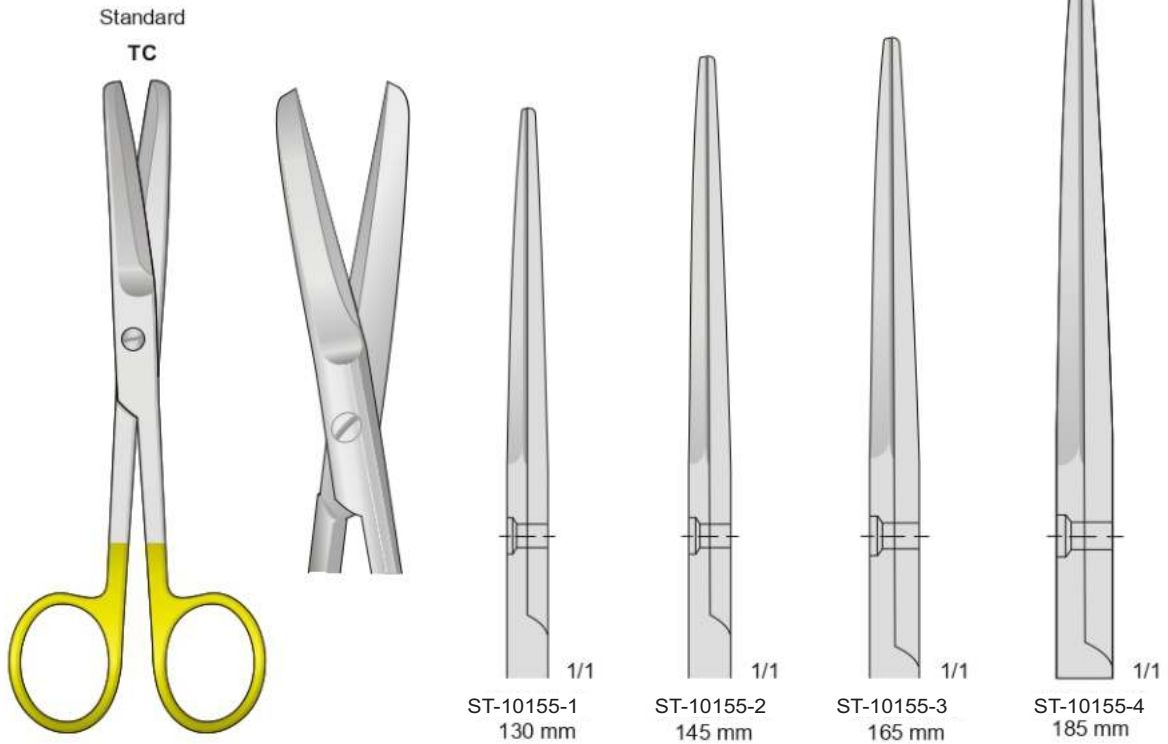
ST-10154

TC

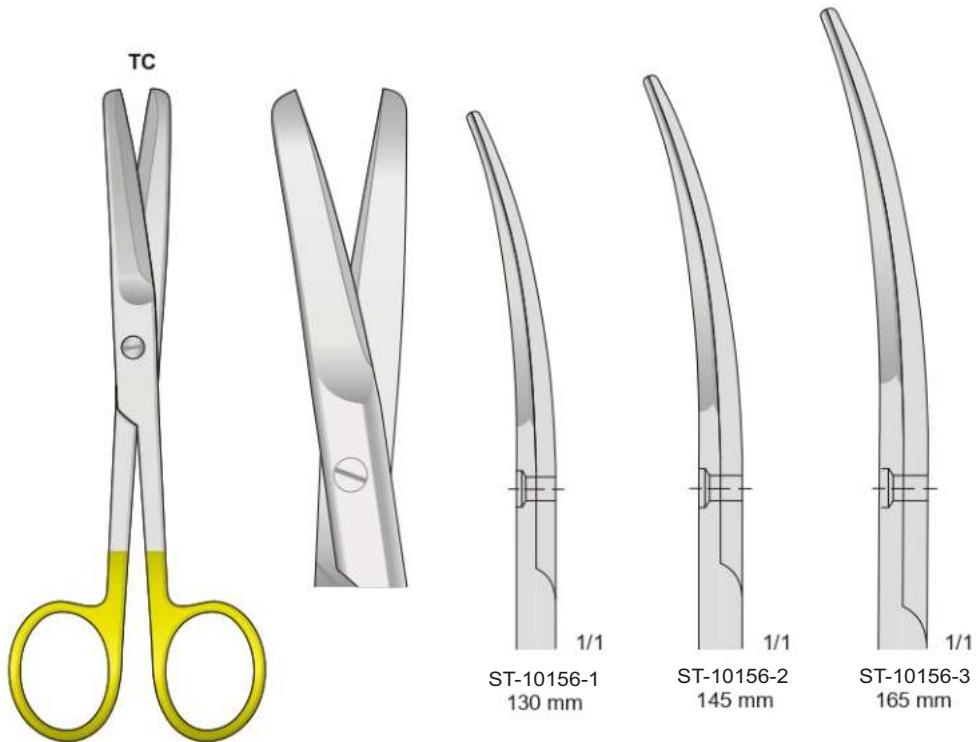




Con punta al carburo di tungsteno - Tungsten-carbide scissors
Mit Hartmetalleinsätzen - Avec plaquettes en carbure de tungstène - Tijeras de tungsteno



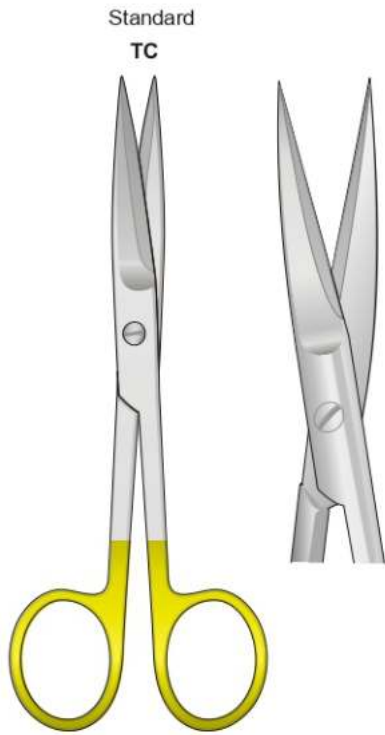
ST-10155



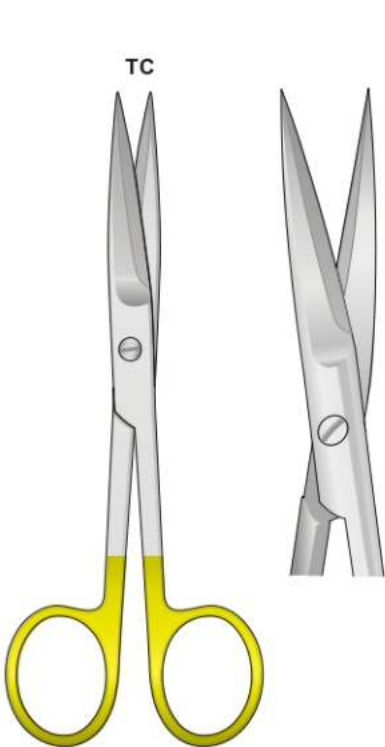
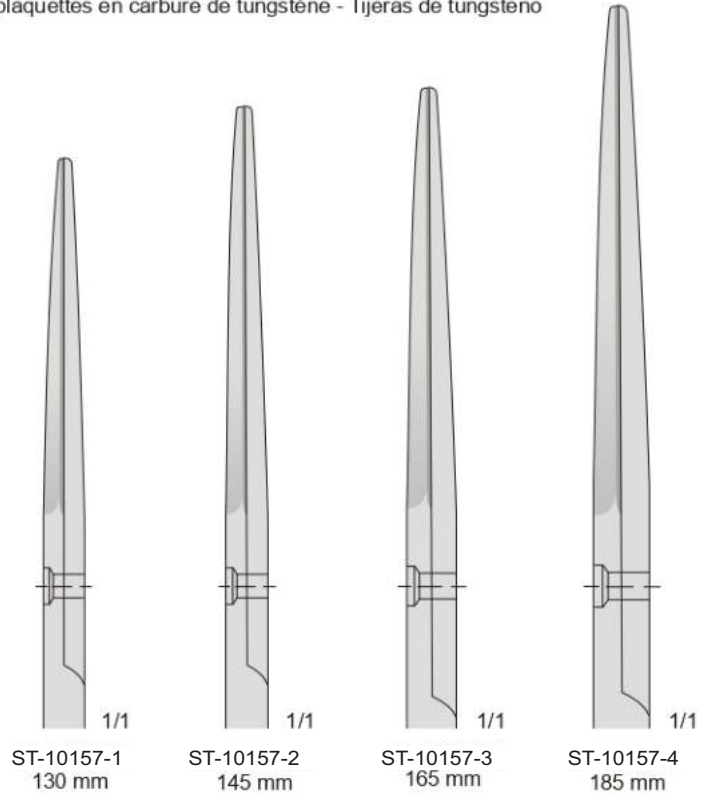
ST-10156



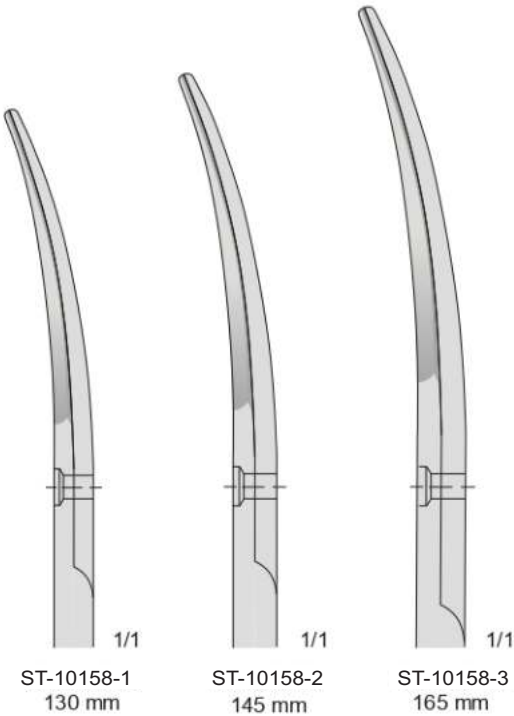
Con punta al carburo di tungsteno - Tungsten-carbide scissors
Mit Hartmetalleinsätzen - Avec plaquettes en carbure de tungstène - Tijeras de tungsteno



ST-10157

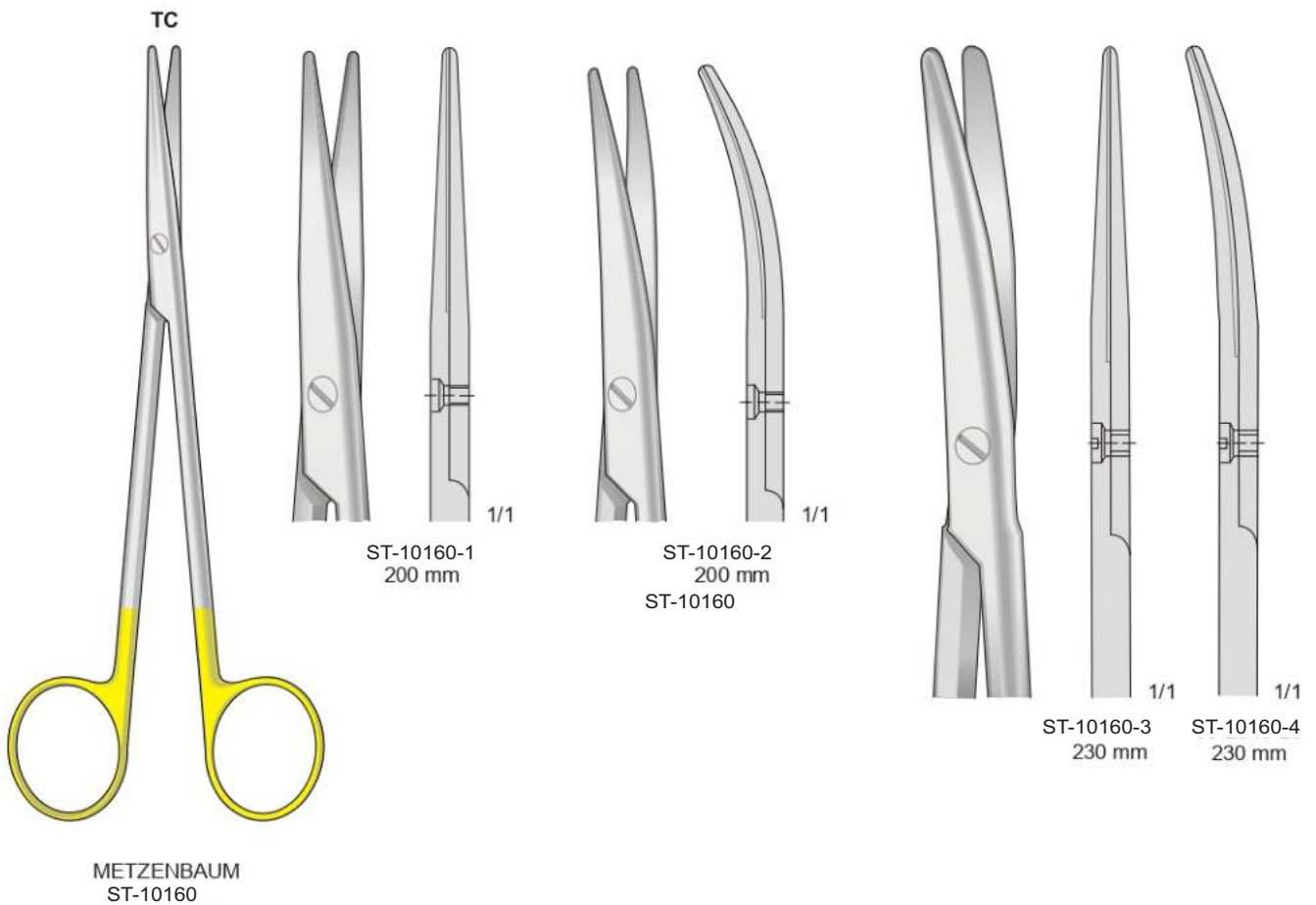
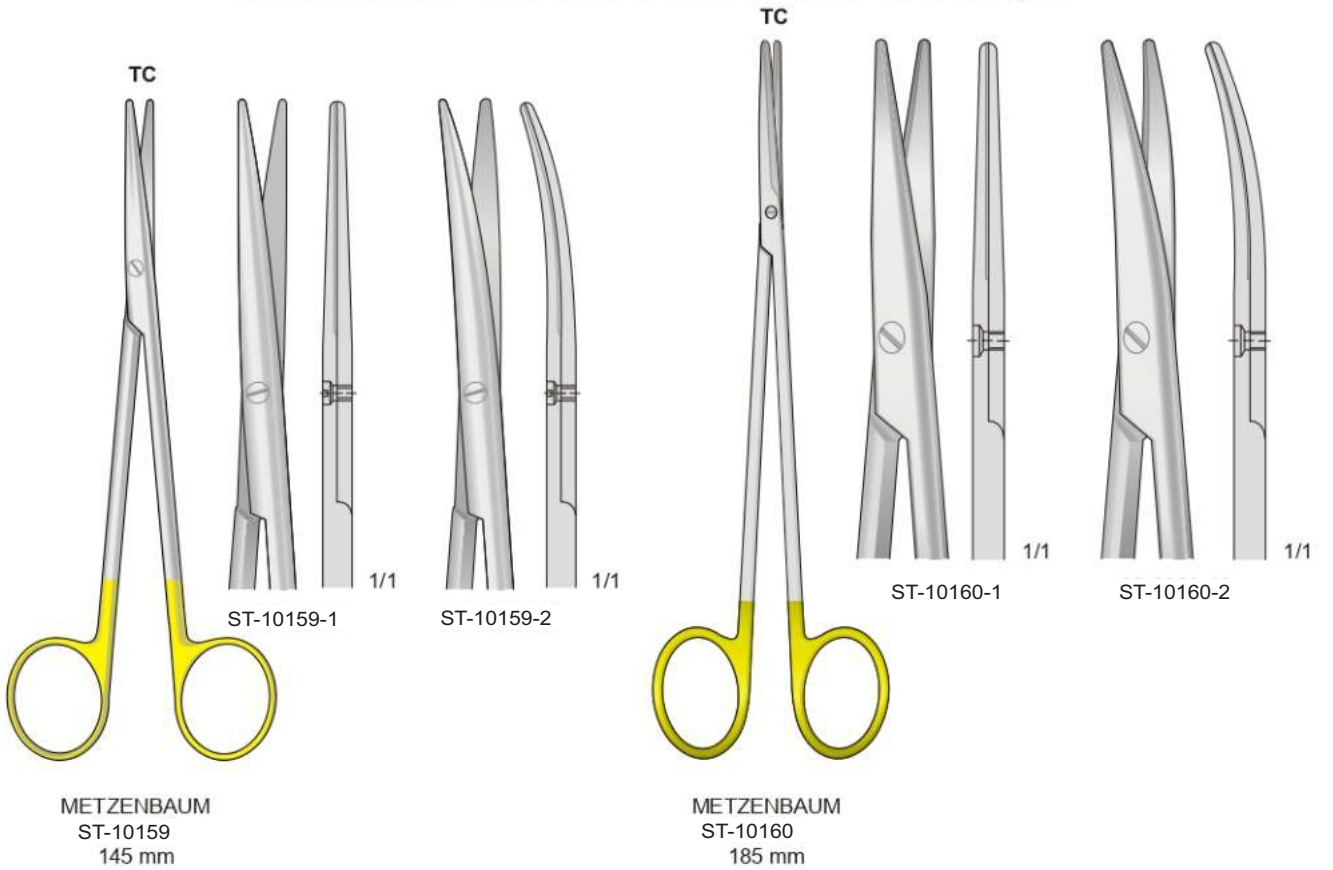


ST-10158





Con punta al carburo di tungsteno - Tungsten-carbide scissors
Mit Hartmetalleinsätzen - Avec plaquettes en carbure de tungstène - Tijeras de tungsteno



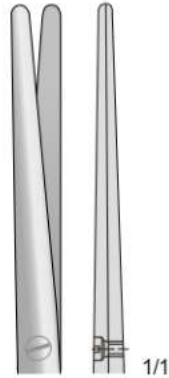


Con punta al carburo di tungsteno - Tungsten-carbide scissors
Mit Hartmetalleinsätzen - Avec plaquettes en carbure de tungstène - Tijeras de tungsteno

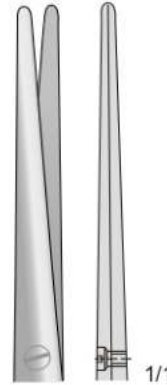
TC



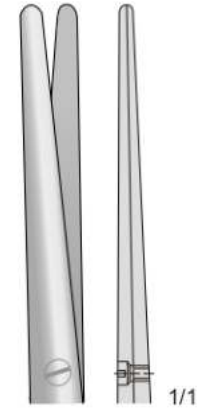
METZENBAUM-FINO
ST-10161



ST-10161-1
140 mm



ST-10161-2
180 mm

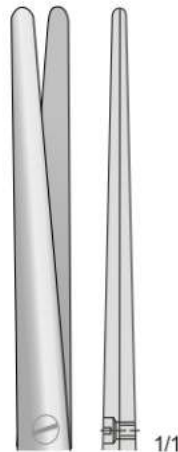


ST-10161-3
200 mm

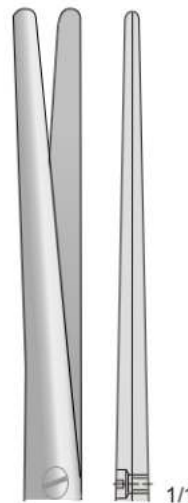
TC



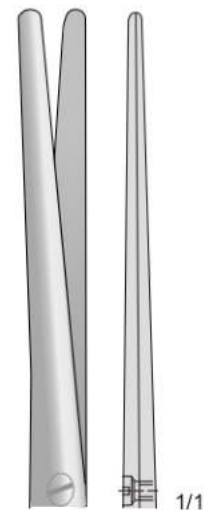
METZENBAUM-FINO
ST-10162



ST-10162-1
230 mm



ST-10162-2
250 mm



ST-10162-3
280 mm

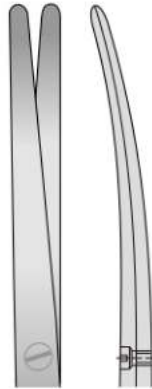


Con punta al carburo di tungsteno - Tungsten-carbide scissors
Mit Hartmetalleinsätzen - Avec plaquettes en carbure de tungstène - Tijeras de tungsteno

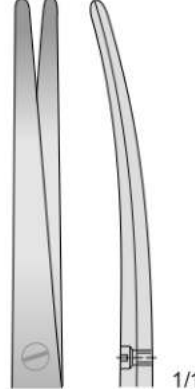
TC



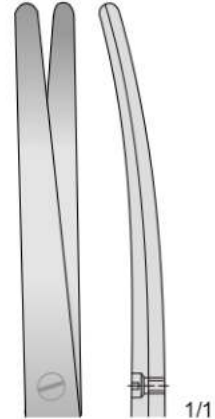
METZENBAUM-FINO
ST-10163



ST-10163-1
140 mm

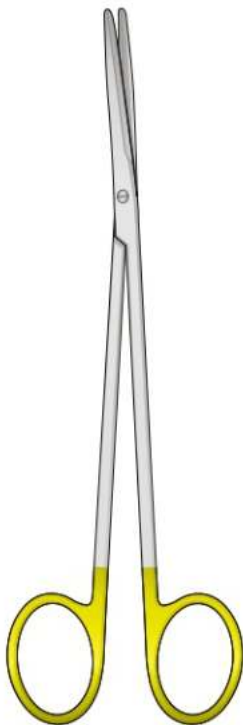


ST-10163-2
180 mm

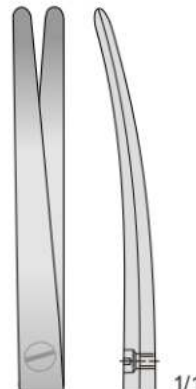


ST-10163-3
200 mm

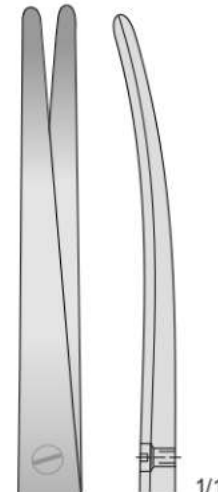
TC



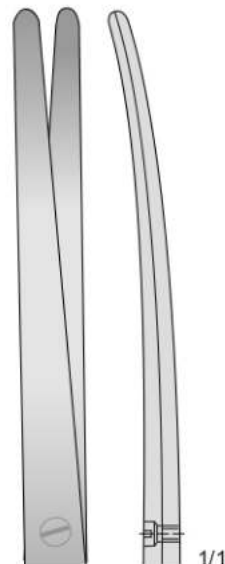
METZENBAUM-FINO
ST-10164



ST-10164-1
230 mm

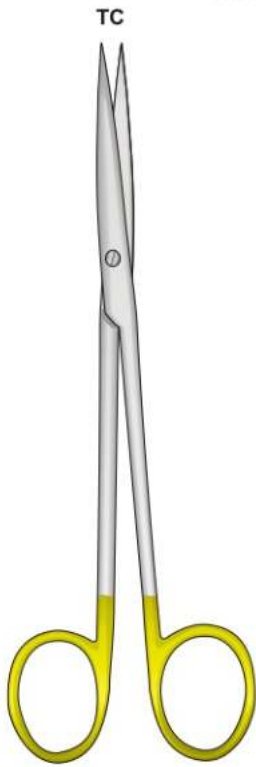


ST-10164-2
250 mm

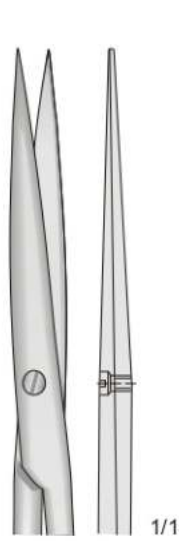


ST-10164-3
280 mm

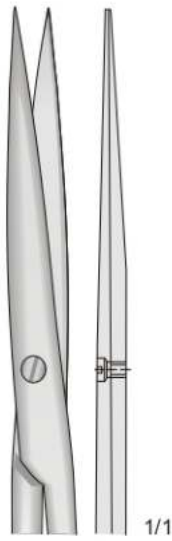
Con punta al carburo di tungsteno - Tungsten-carbide scissors
Mit Hartmetalleinsätzen - Avec plaquettes en carbure de tungstène - Tijeras de tungsteno



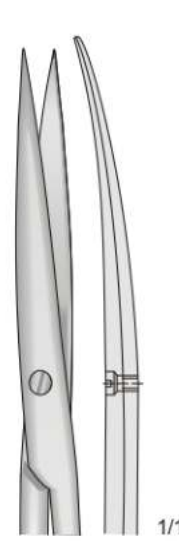
METZENBAUM-FINO
ST-10165



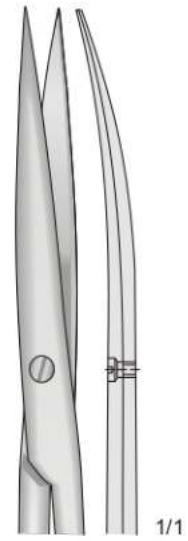
ST-10165-1
140 mm



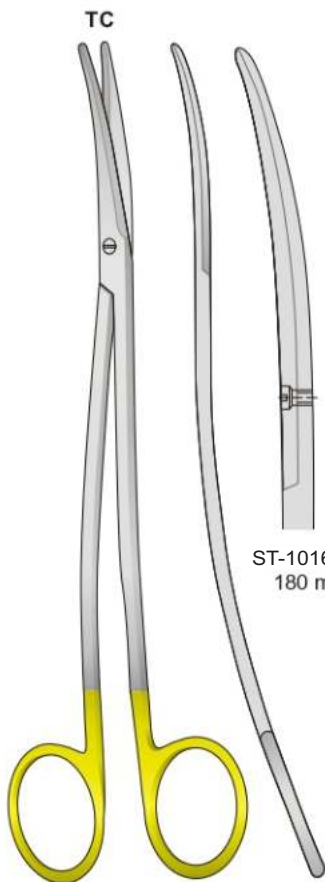
ST-10165-2
180 mm



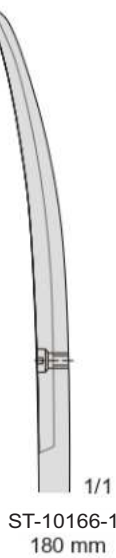
ST-10165-3
140 mm



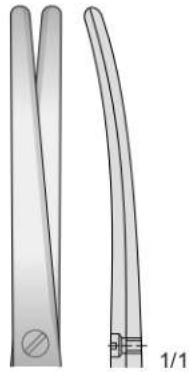
ST-10165-4
180 mm



METZENBAUM-FINO
ST-10166



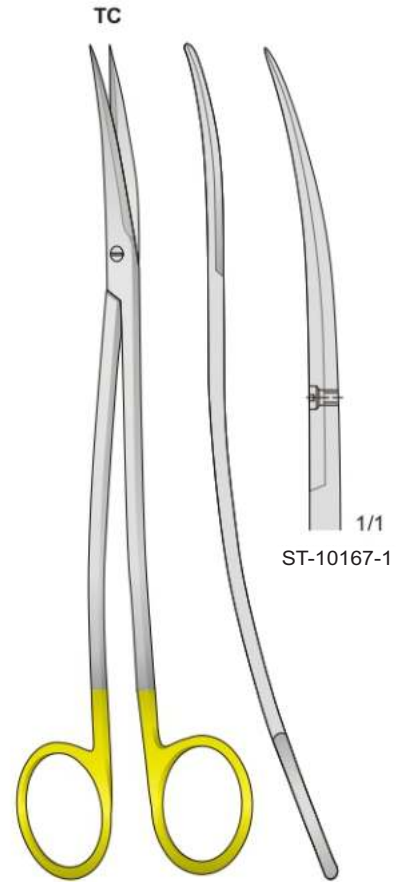
ST-10166-1
180 mm



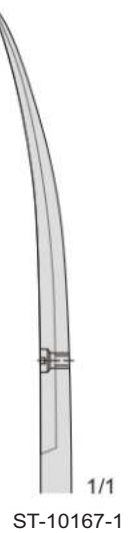
ST-10166-2
200 mm



ST-10166-3
230 mm



METZENBAUM-FINO
ST-10167
180 mm

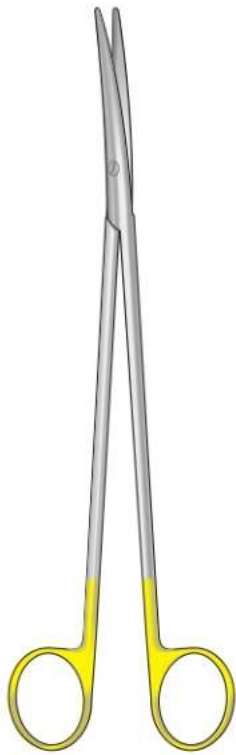


ST-10167-1

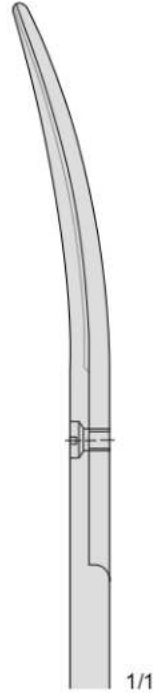


TC

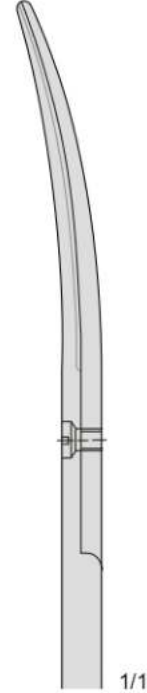
Con punta al carburo di tungsteno - Tungsten-carbide scissors
Mit Hartmetalleinsätzen - Avec plaquettes en carbure de tungstène
Tijeras de tungsteno



NELSON-METZENBAUM
ST-10168

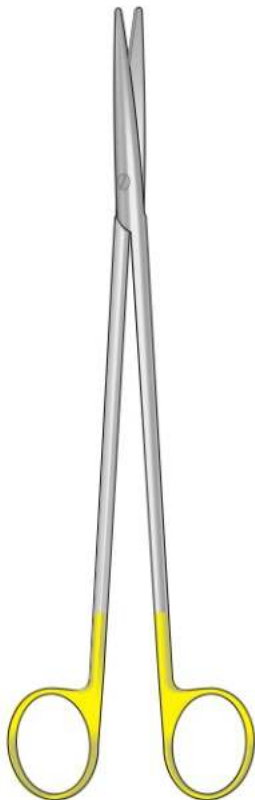


ST-10168-1
260 mm



ST-10168-2
280 mm

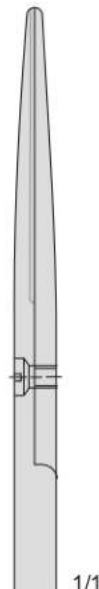
TC



NELSON-METZENBAUM
ST-10169



ST-10169-1
230 mm



ST-10169-2
230 mm



ST-10169-3
300 mm

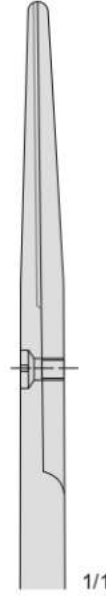


TC

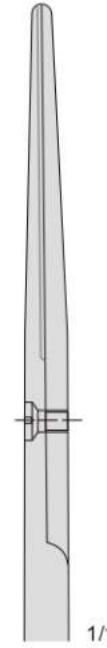
Con punta al carburo di tungsteno - Tungsten-carbide scissors
Mit Hartmetalleinsätzen - Avec plaquettes en carbure de tungstène - Tijeras de tungsteno



MAYO-STILLE
ST-10170

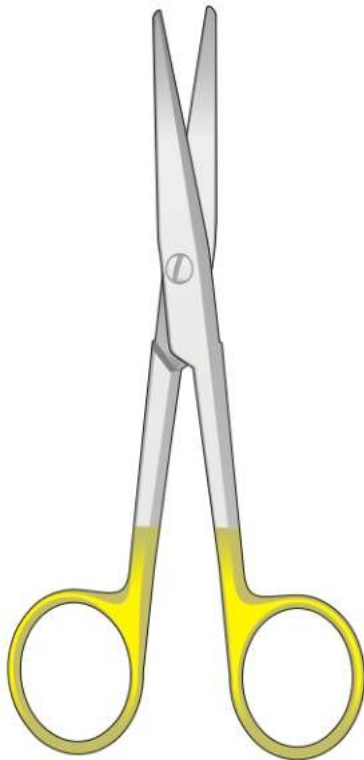


ST-10170-1
140 mm

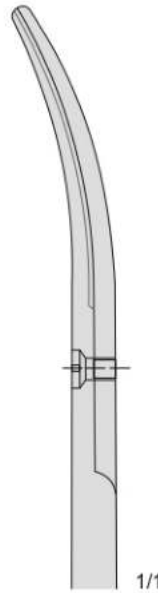


ST-10170-2
170 mm

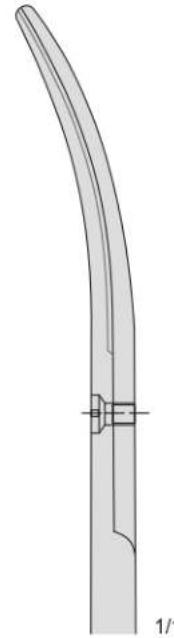
TC



MAYO-STILLE
ST-10171



ST-10171-1
140 mm

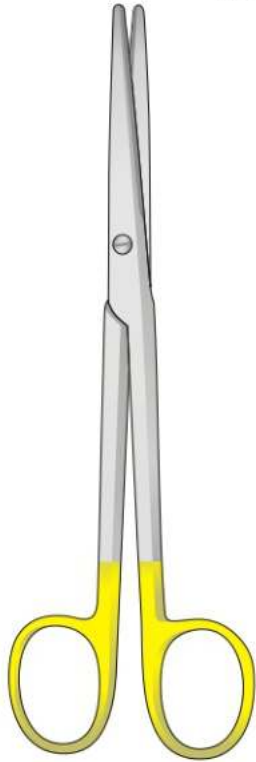


ST-10171-2
170 mm

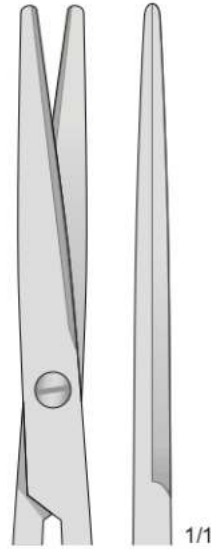


TC

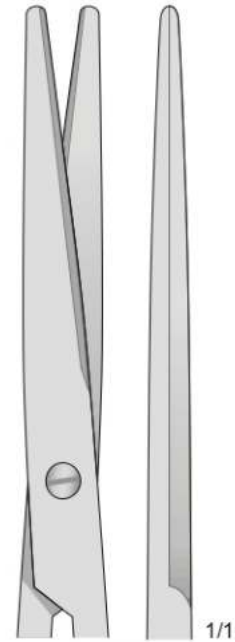
Con punta al carburo di tungsteno - Tungsten-carbide scissors
Mit Hartmetalleinsätzen - Avec plaquettes en carbure de tungstène - Tijeras de tungsteno



LEXER
ST-10172

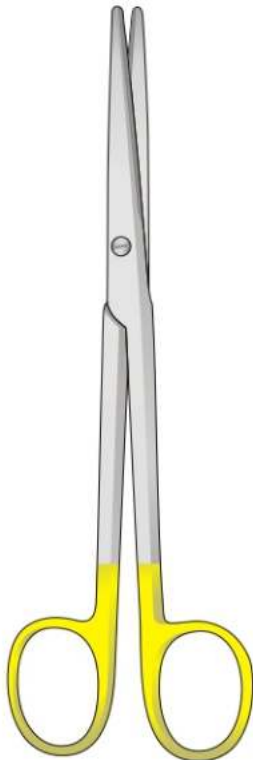


ST-10172-1
160 mm

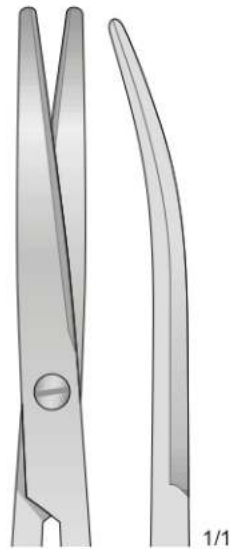


ST-10172-2
210 mm

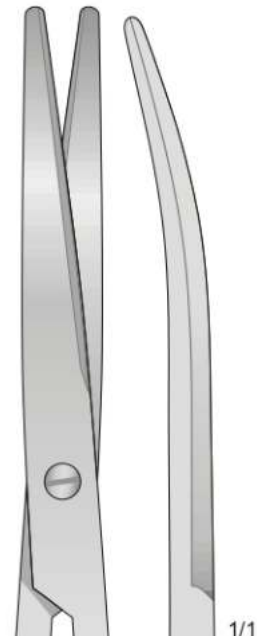
TC



LEXER
ST-10173



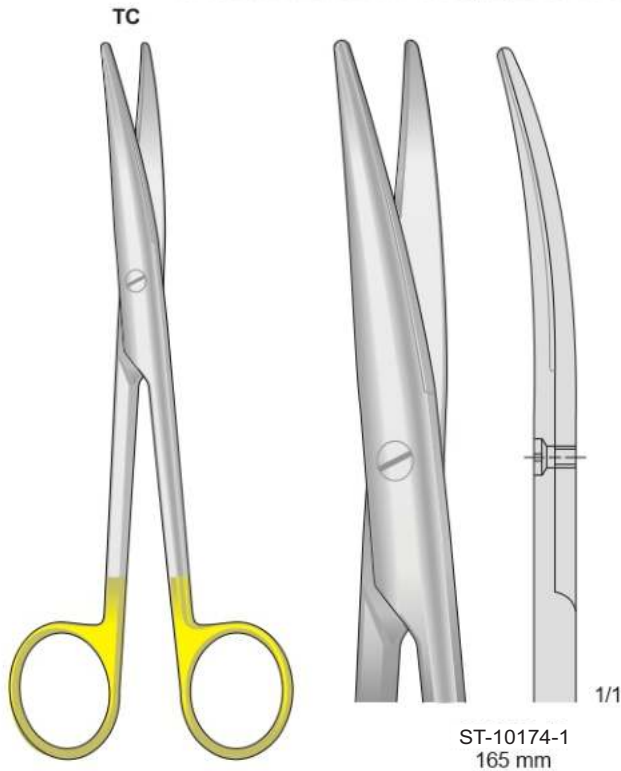
ST-10173-1
160 mm



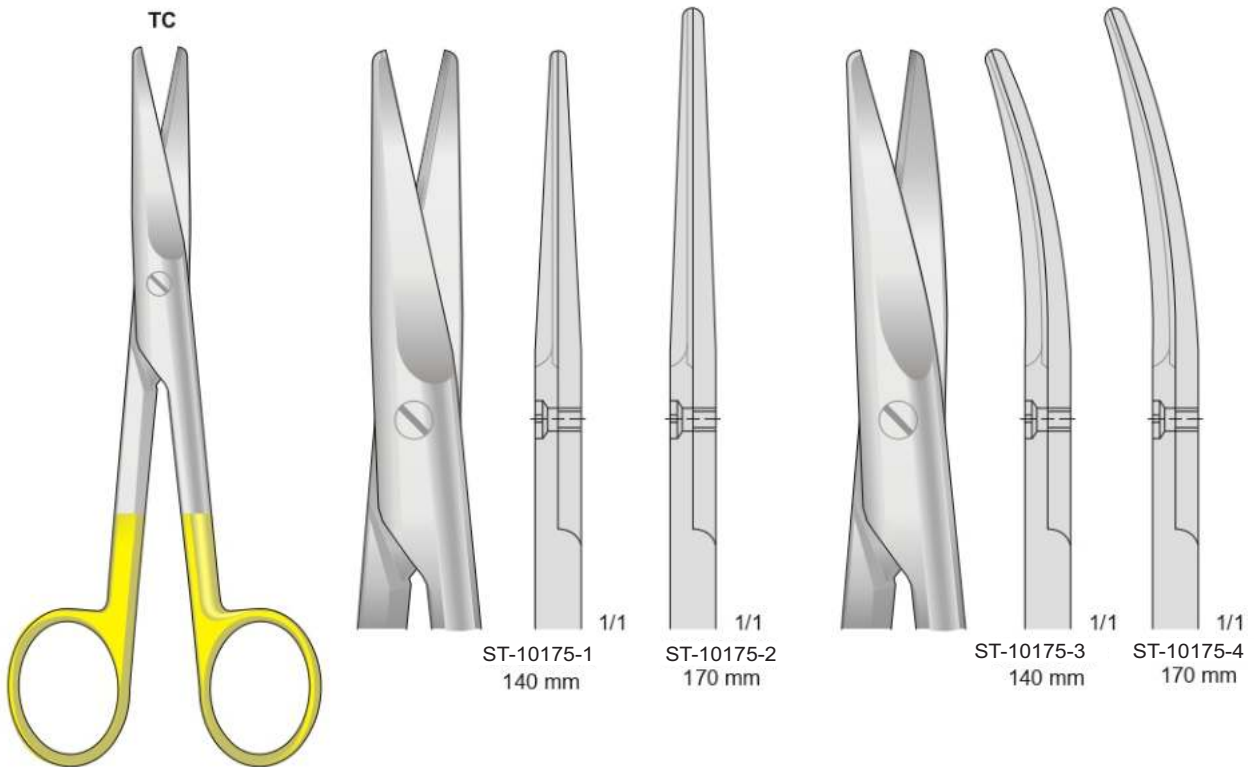
ST-10173-2
210 mm



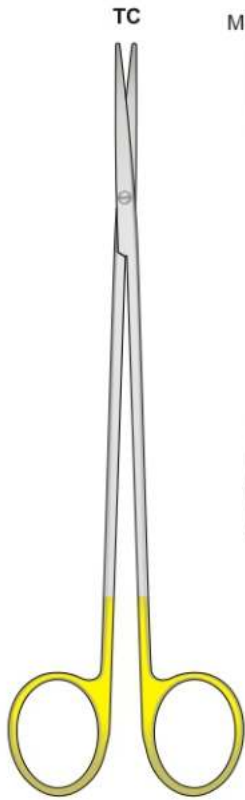
Con punta al carburo di tungsteno - Tungsten-carbide scissors
Mit Hartmetalleinsätzen - Avec plaquettes en carbure de tungstène - Tijeras de tungsteno



MAYO-LEXER
ST-10174
165 mm

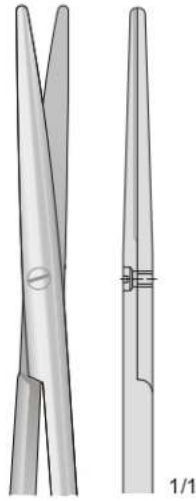


MAYO
ST-10175

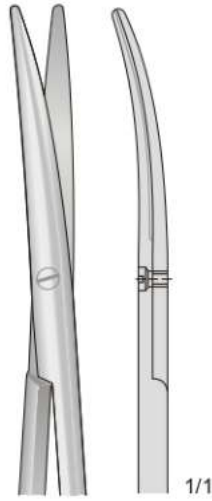


TOENNIS-ADSON
ST-10176
180 mm

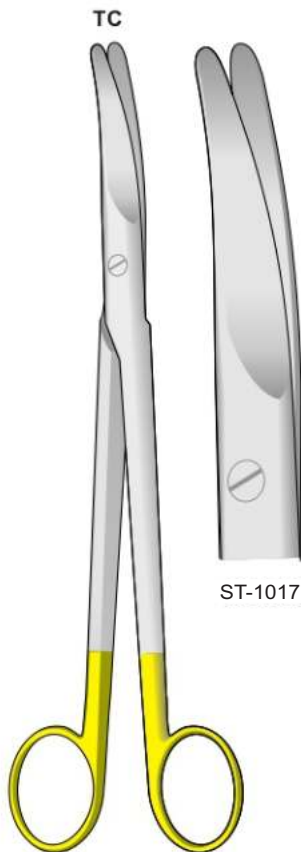
TC
Con punta al carburo di tungsteno - Tungsten-carbide scissors
Mit Hartmetalleinsätzen - Avec plaquettes en carbure de tungstène - Tijeras de tungsteno



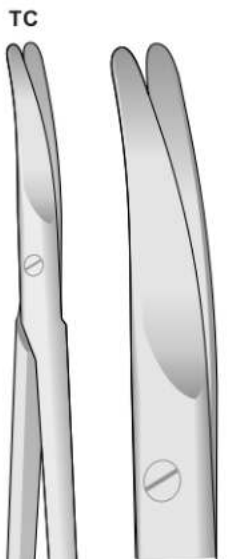
ST-10176-1



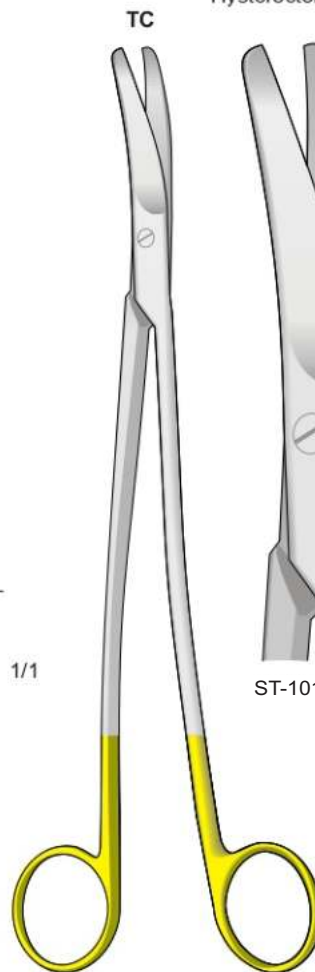
ST-10176-2



PARAMETRIUM-PARAMETRIO
ST-10177
225 mm

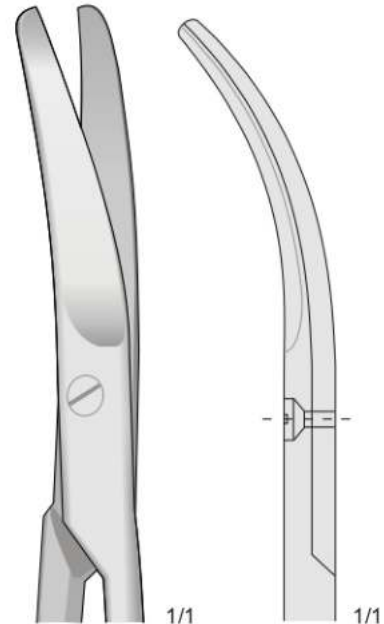


ST-10177-1



ST-10178
250 mm

TC
Forbice per isterectomia - Hysterectomy Scissors
Hysterectomie Scheren - Ciseaux à Hystérérectomie
Tijera para Histerectomia



ST-10178-1



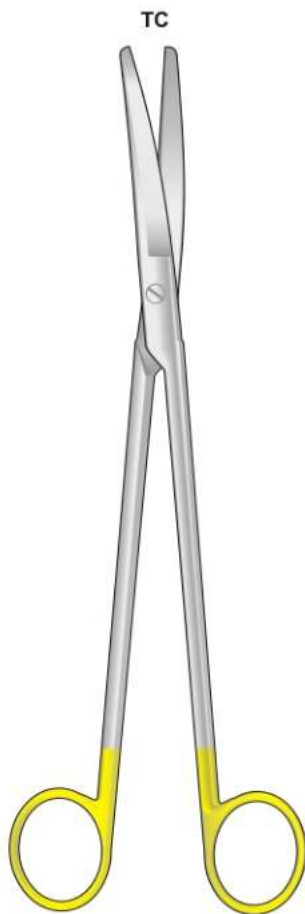
1/1



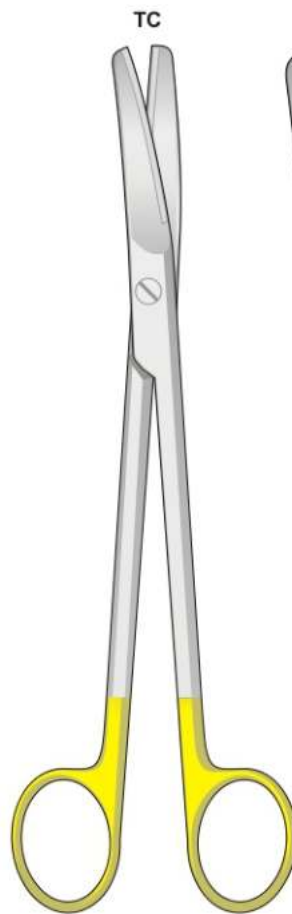
ST-10179-1

ST-10179-2

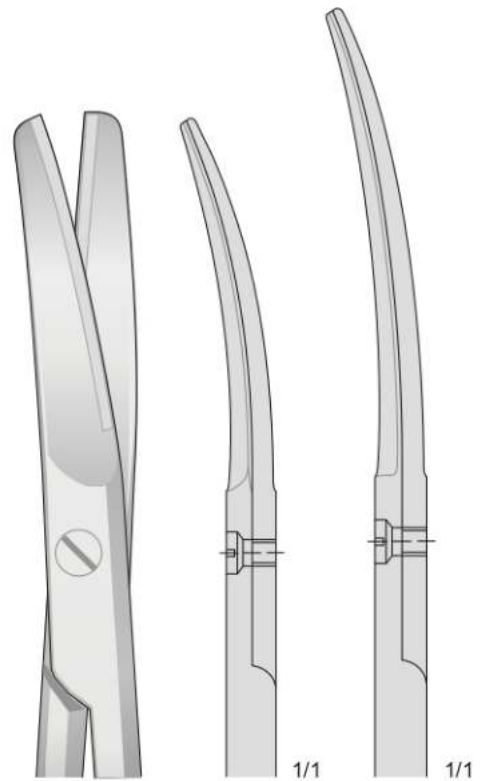
Con punta al carburo di tungsteno
Tungsten-carbide scissors
Mit Hartmetalleinsätzen
Avec plaquettes en carbure de tungstène
Tijeras de tungsteno



WERTHEIM
ST-10179
230 mm



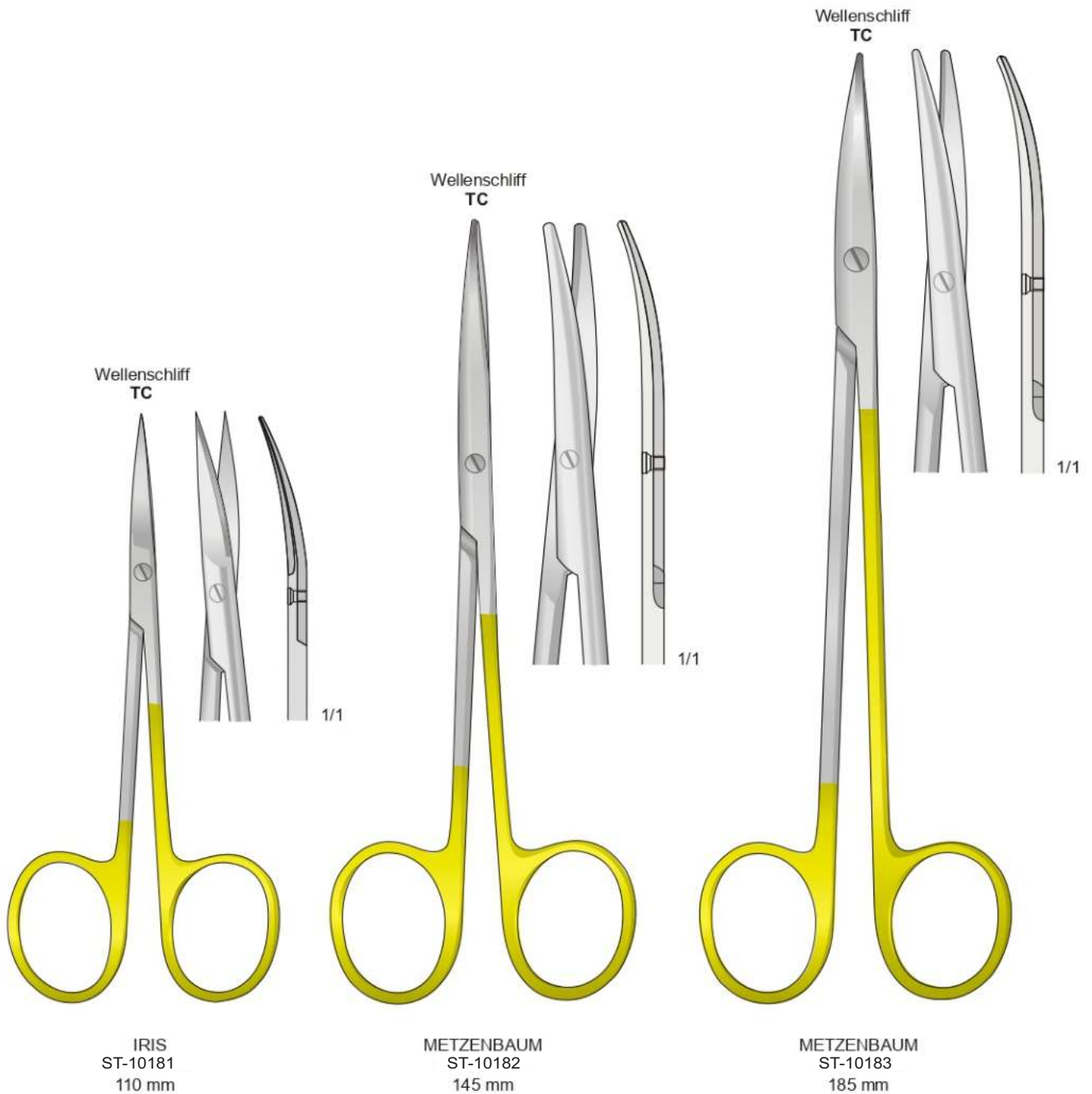
SIMS
ST-10180

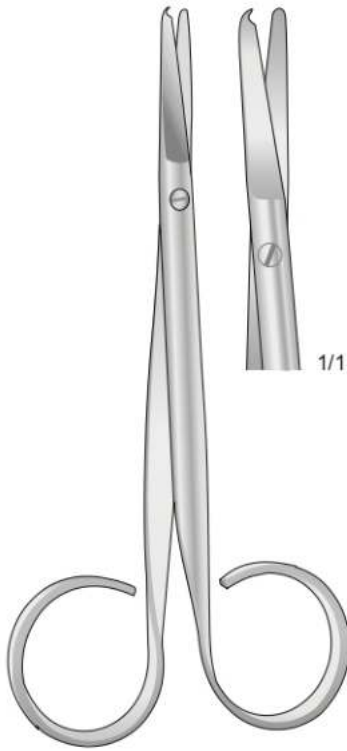


ST-10180-1
200 mm

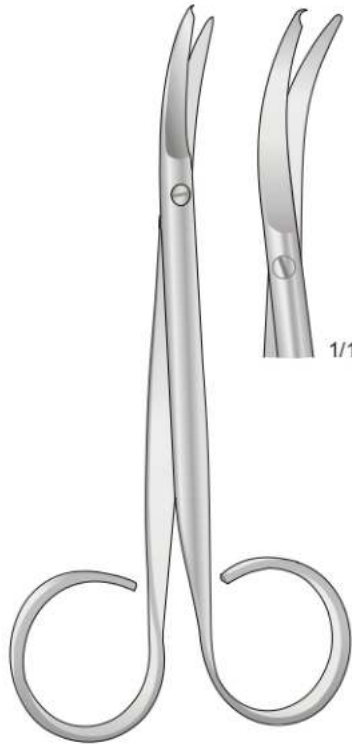
ST-10180-2
230 mm

Forbici con taglio ondulato su una lama
 Scissors cut one serrated cutting edge
 Scheren mit wellenschliff auf einer Schnittfläche
 Ciseaux avec affutage spécial ont une lame dentée

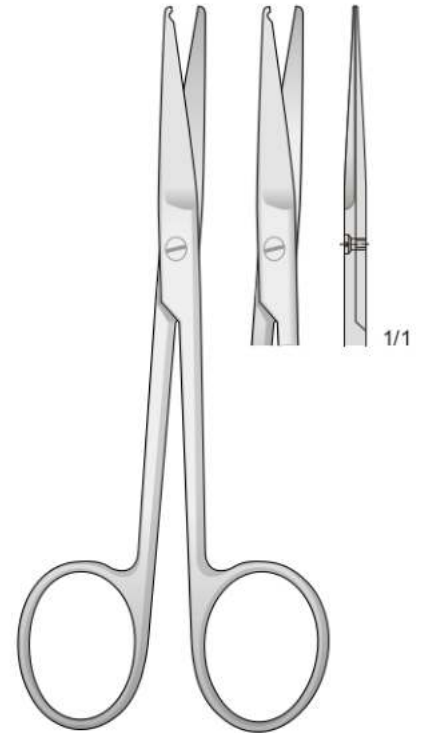




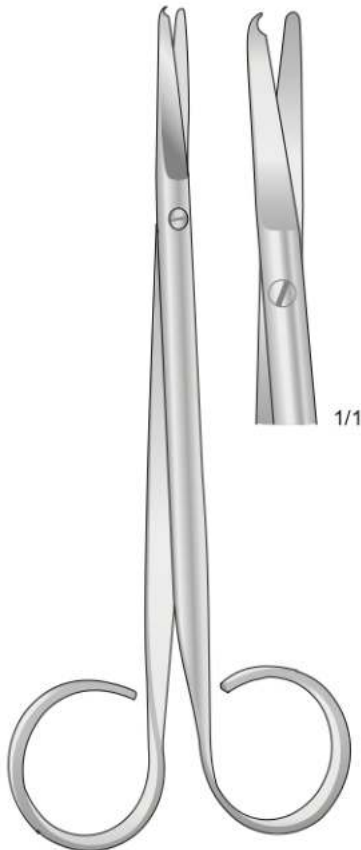
SPENCER
ST-10184
110 mm



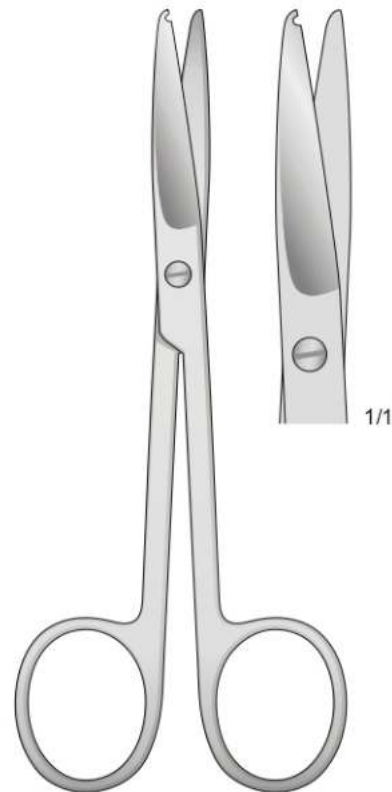
SPENCER
ST-10185
110 mm



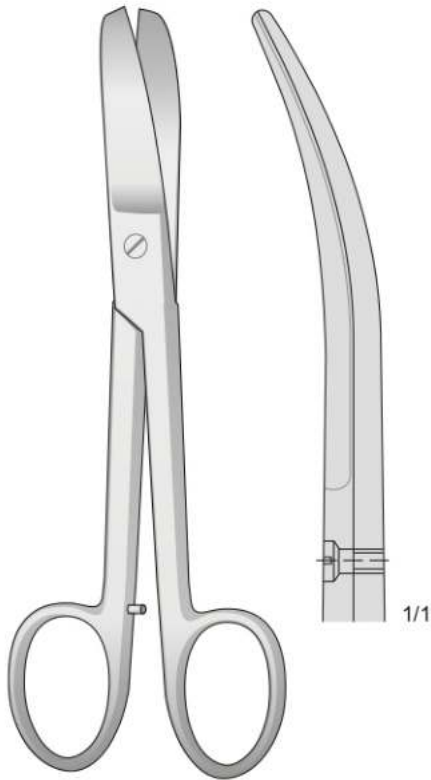
ST-10186
115 mm



SPENCER
ST-10187
145 mm



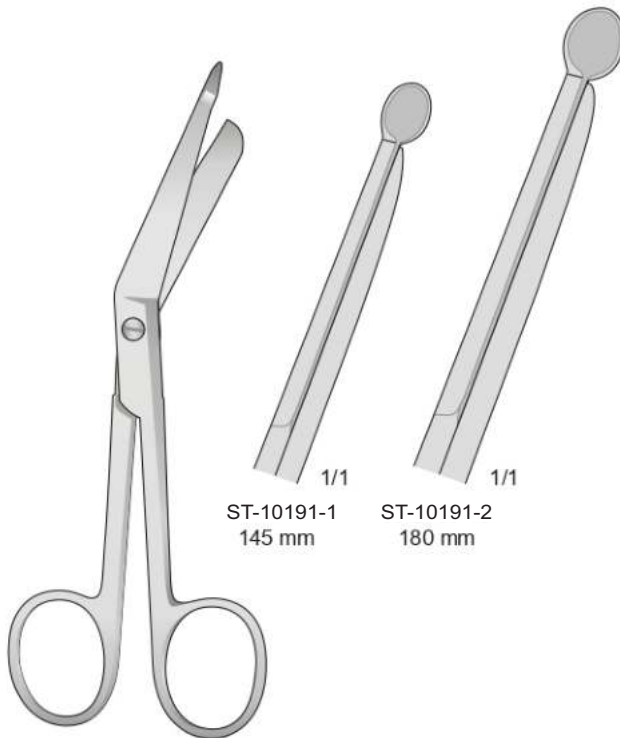
SPENCER
ST-10188
135 mm



LORENZ
ST-10189
230 mm



BRUNS
ST-10190
240 mm



LISTER
ST-10191

ST-10191-1
145 mm

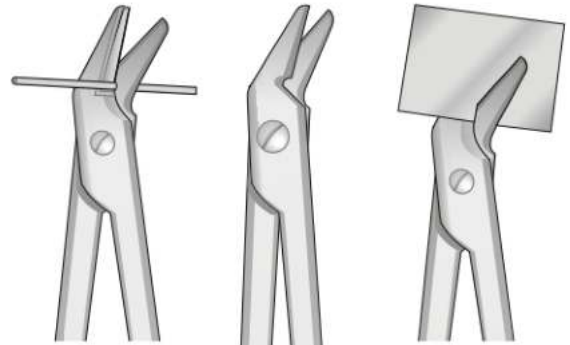
ST-10191-2
180 mm



ESMARCH
ST-10192

ST-10192-1
200 mm

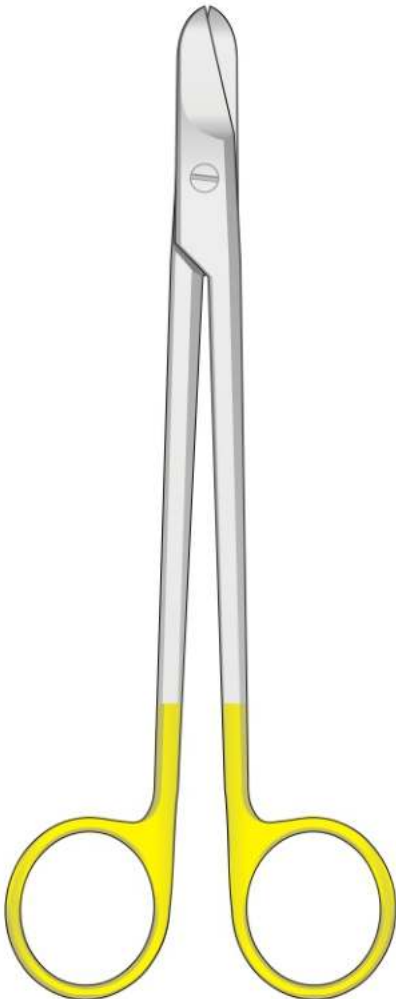
Forbice universale dentellata
Draht-und Blechschere gezahnt
Wire cutting scissor serrated
Coupe-fils dentelés
Tijeras para cortar hilo de acero dentadas



ST-10196
120 mm

Con punta al carburo di tungsteno
Tungsten-carbide scissors
Mit Hartmetalleinsätzen
Avec plaquettes en carbure de tungstène
Tijeras de tungsteno

Wire Cutter
TC



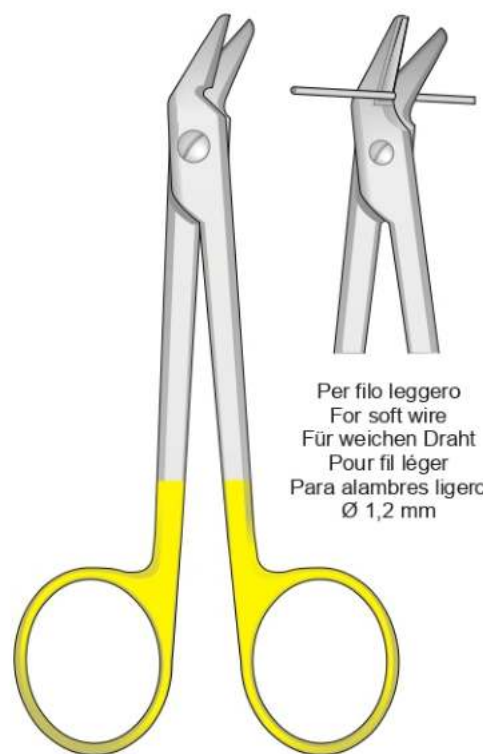
SMITH
ST-10193
160 mm

Wire Cutter
TC



SMITH
ST-10194
160 mm

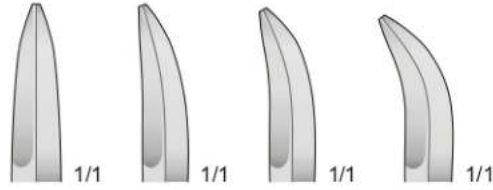
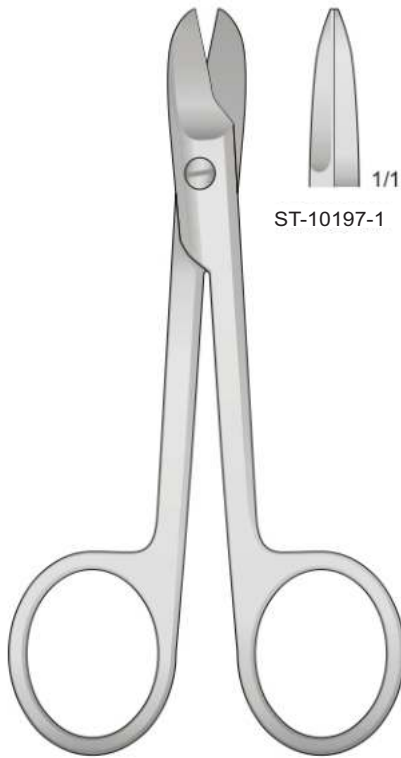
TC



Per filo leggero
For soft wire
Für weichen Draht
Pour fil léger
Para alambres ligero
Ø 1,2 mm

ST-10195
120 mm

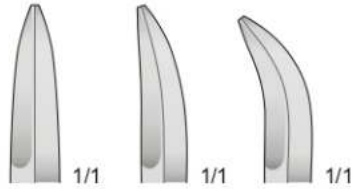
Smusse - Blunt - Stumpf - Mouses - Romas



ST-10197-1 ST-10197-2 ST-10197-3 ST-10197-4

BEEBE
ST-10197
110 mm

Acute - Sharp - Spitz - Pointus - Agudas

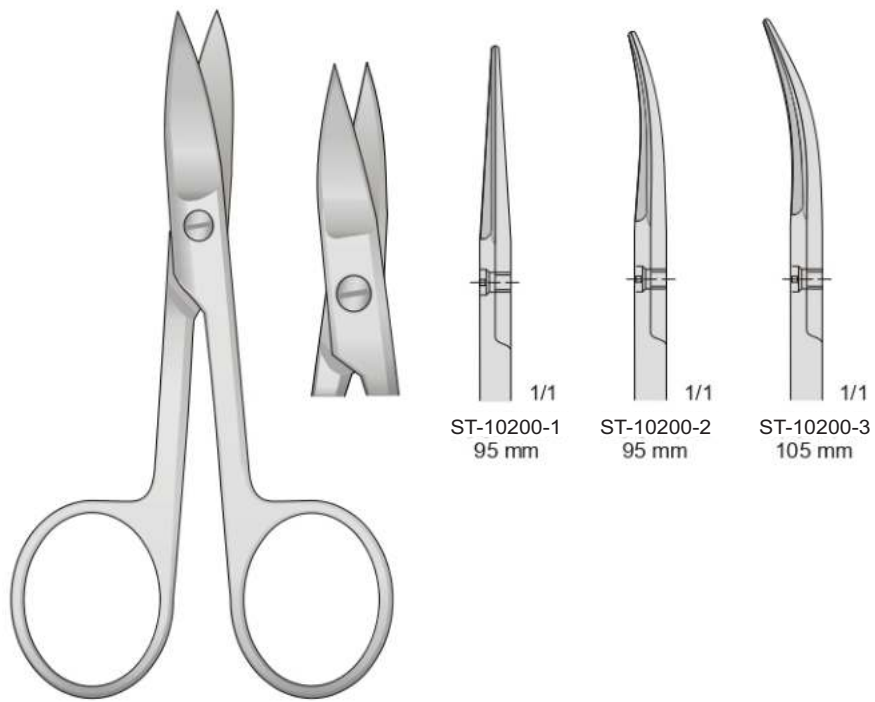


ST-10198-1 ST-10198-2 ST-10198-3

BEEBE
ST-10198
110 mm



ST-10199



ST-10200

Tissue and Dressing Forceps

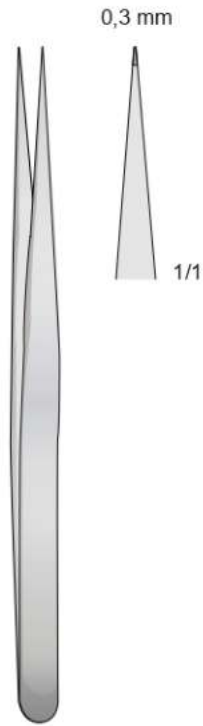


SAFE TOOL
MANUFACTURER & EXPORTER

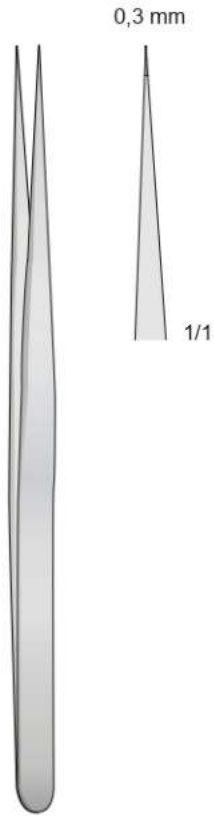


www.safetool.com.pk

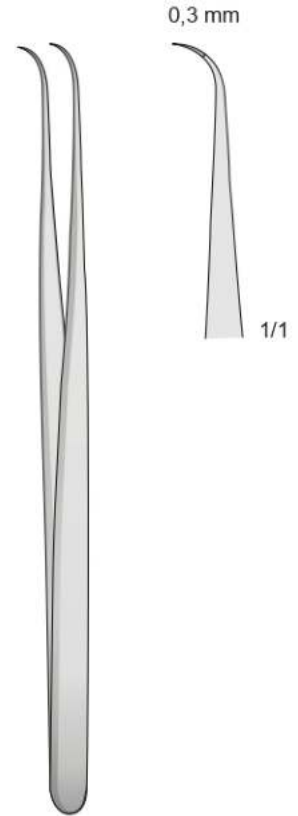
**Surgical
Instruments**



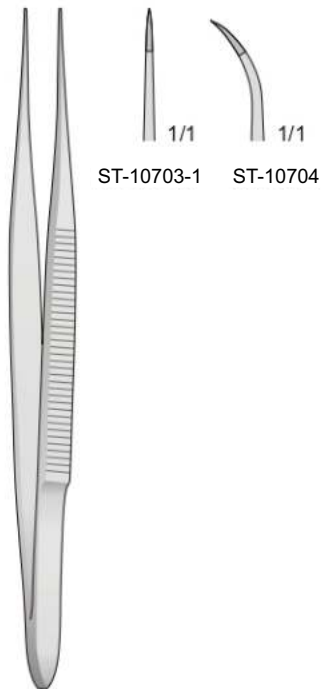
ST-10701-1
120 mm



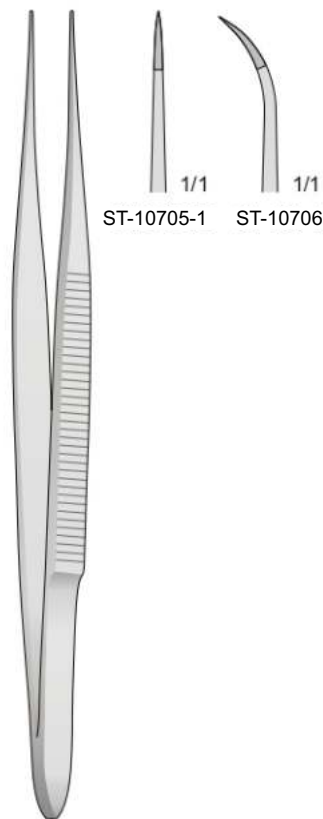
VISE
ST-10701-2
135 mm



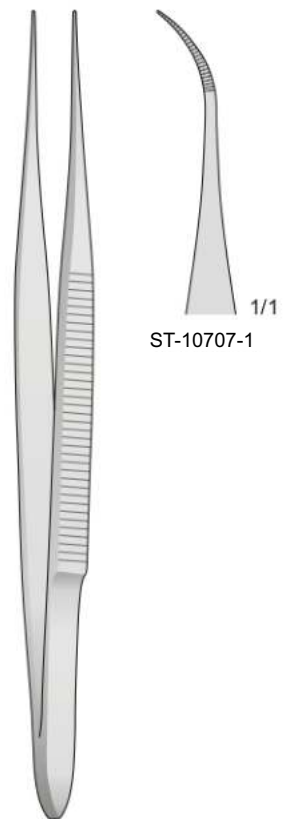
VISE
ST-10702
135 mm



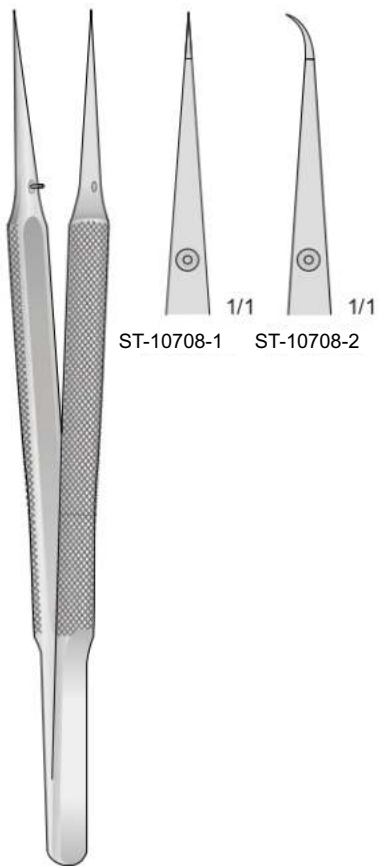
ST-10703
125 mm



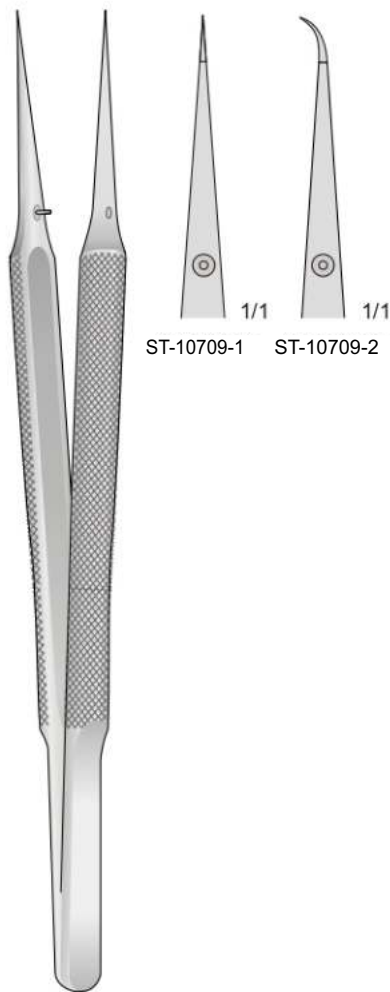
ST-10705
150 mm



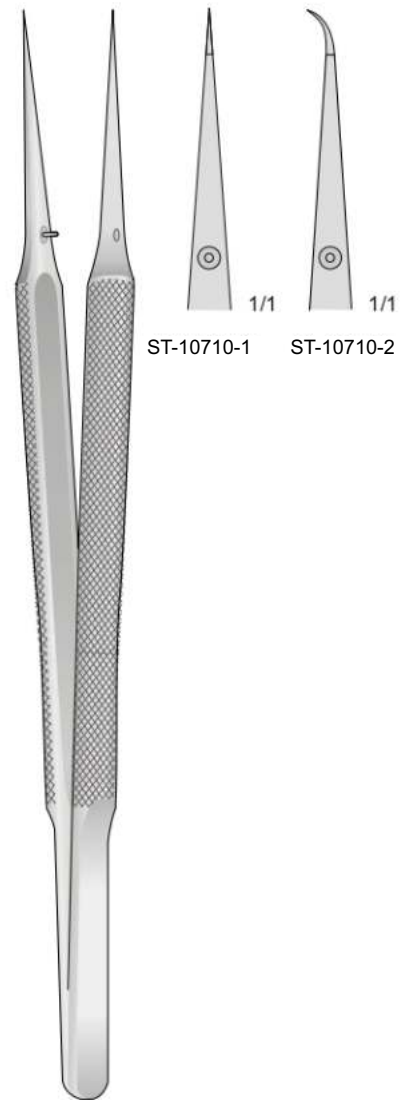
ST-10707
150 mm



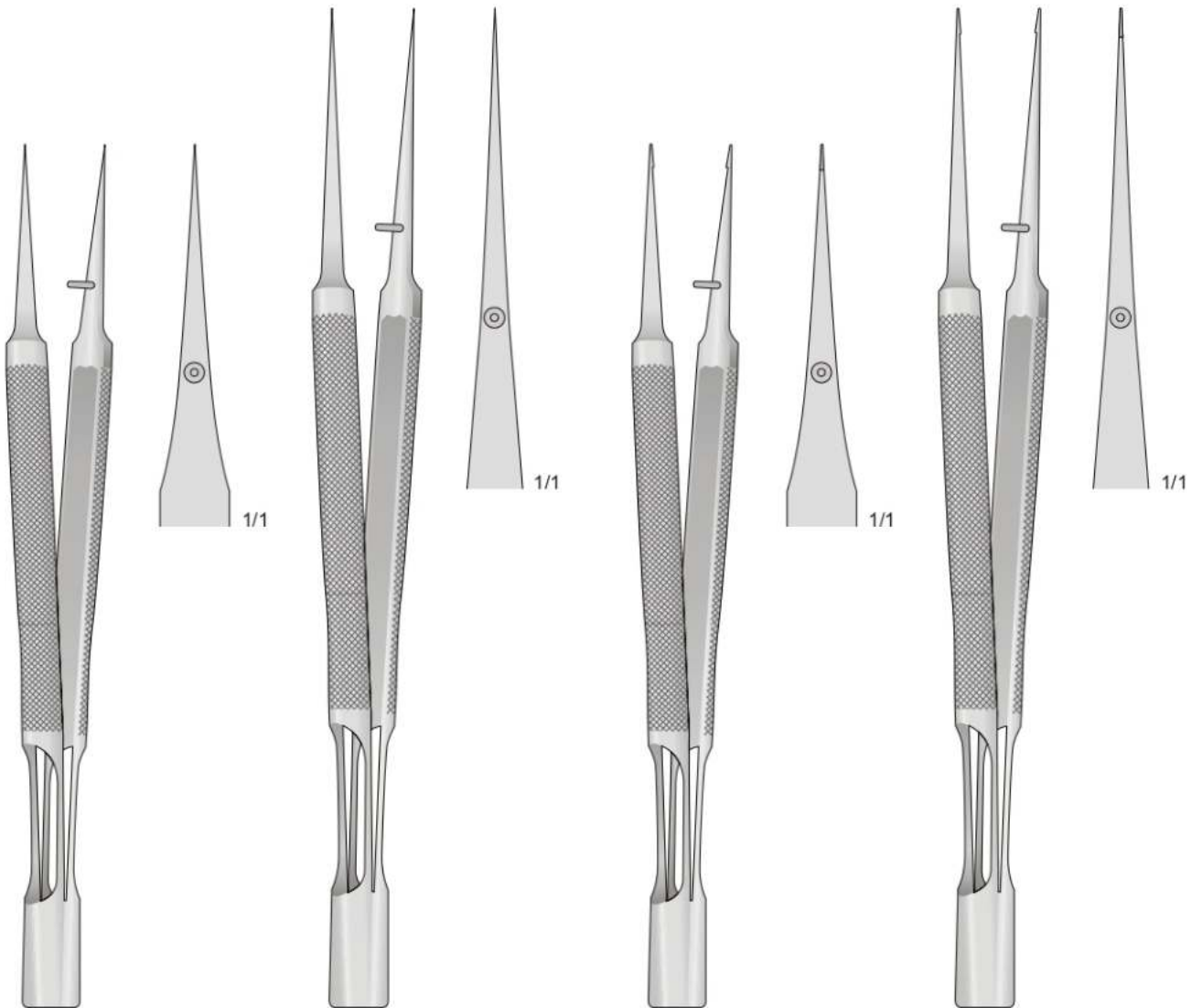
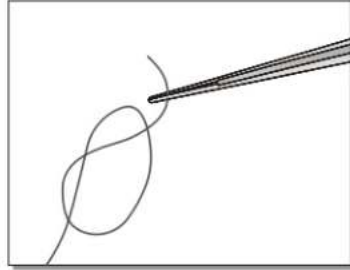
ST-10708
120 mm



ST-10709
150 mm



ST-10710
180 mm

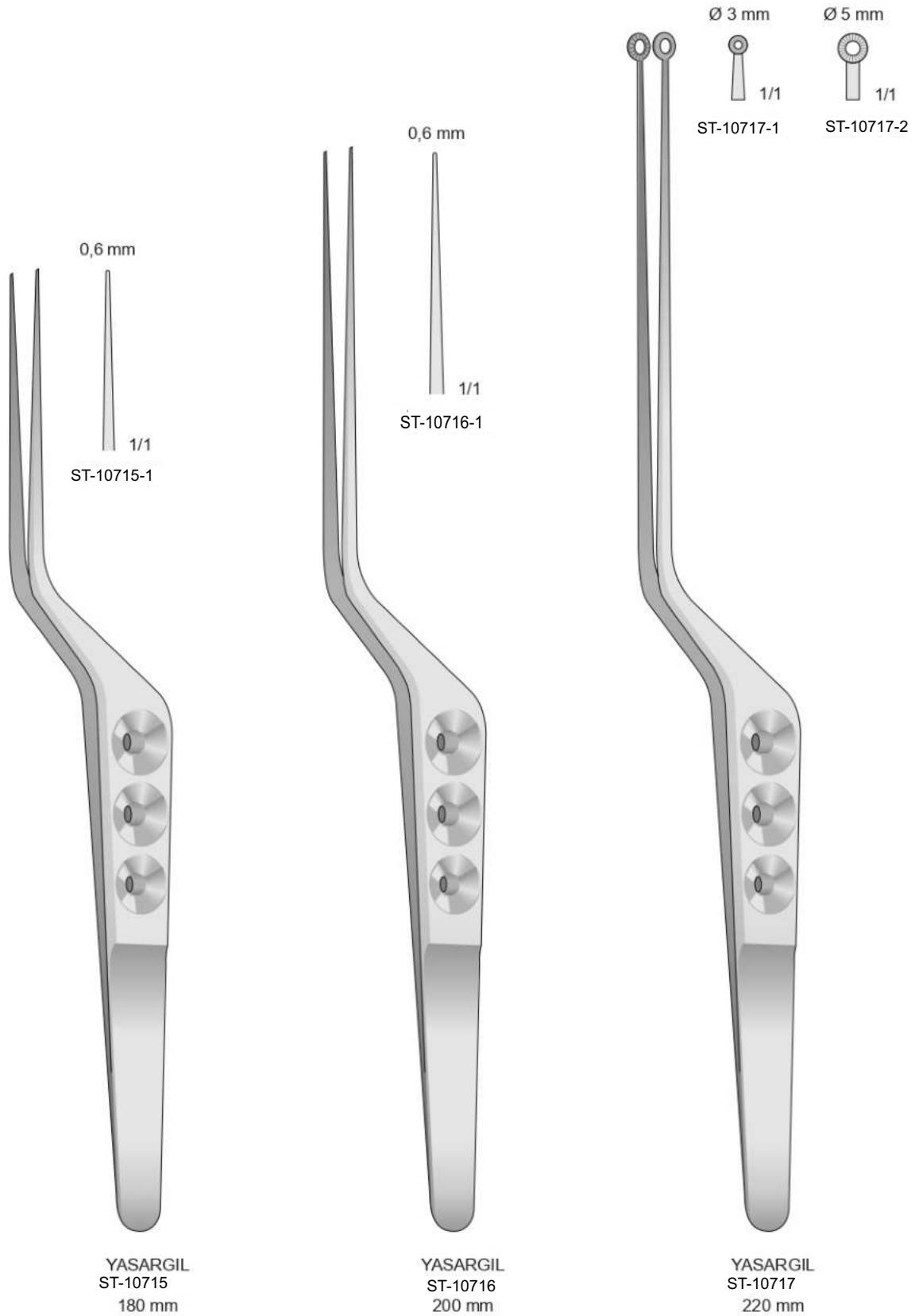


BROCK
ST-10711
130 mm

BROCK
ST-10712
150 mm

BROCK
ST-10713
130 mm

BROCK
ST-10714
150 mm





ST-10718

Ø 1 mm



- ST-10718-1 - 150 mm
- ST-10718-2 - 180 mm
- ST-10718-3 - 210 mm
- ST-10718-4 - 230 mm

Ø 2 mm



- ST-10719-1 - 150 mm
- ST-10719-2 - 180 mm
- ST-10719-3 - 210 mm
- ST-10719-4 - 230 mm



ST-10720

Titanio - Titan - Titane

Ø 1 mm

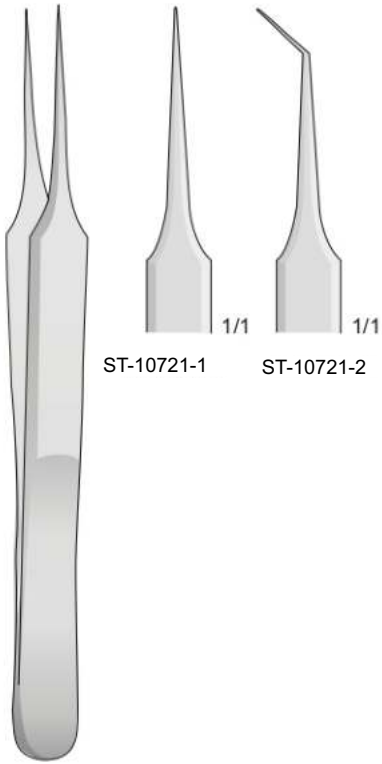


- ST-10720-1 - 150 mm
- ST-10720-2 - 180 mm
- ST-10720-3 - 210 mm

Ø 2 mm



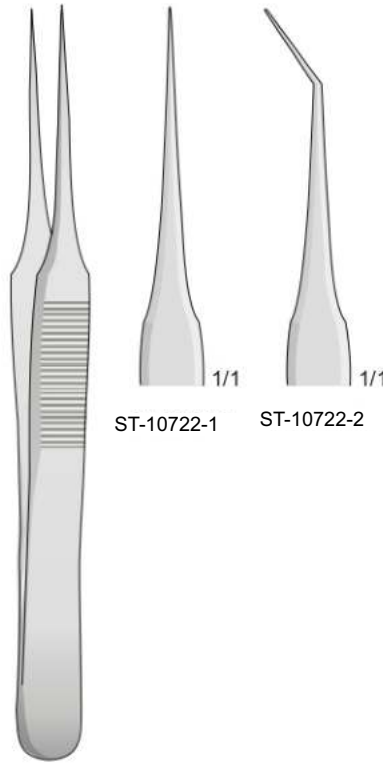
- ST-10720-4 - 150 mm
- ST-10720-5 - 180 mm
- ST-10720-6 - 210 mm



ST-10721-1

ST-10721-2

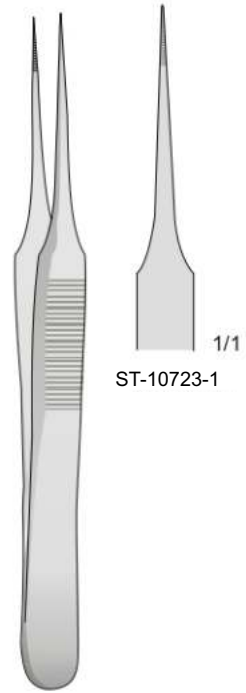
ST-10721
110 mm



ST-10722-1

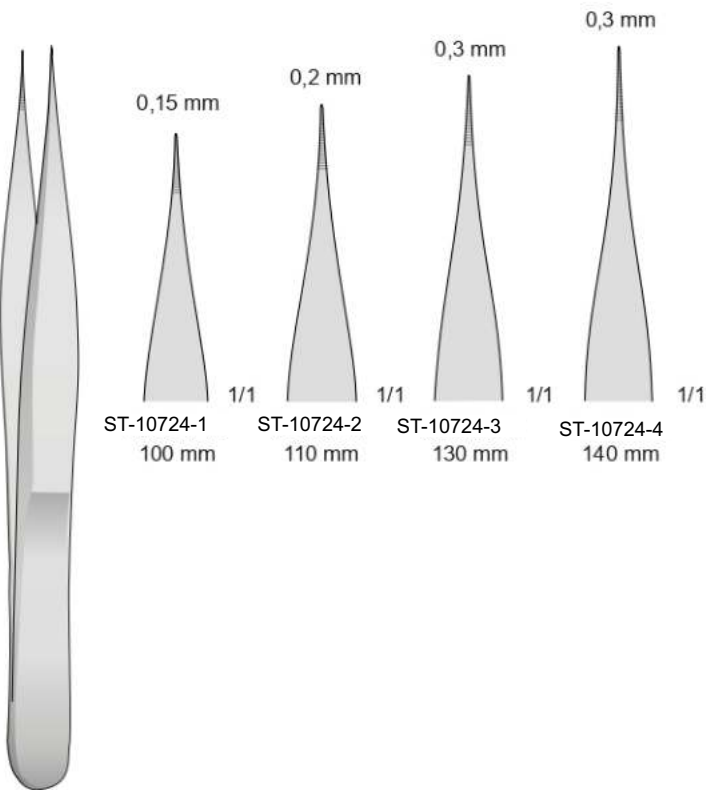
ST-10722-2

ST-10722
110 mm



ST-10723-1

ST-10723
90 mm



ST-10724-1
100 mm

ST-10724-2
110 mm

ST-10724-3
130 mm

ST-10724-4
140 mm

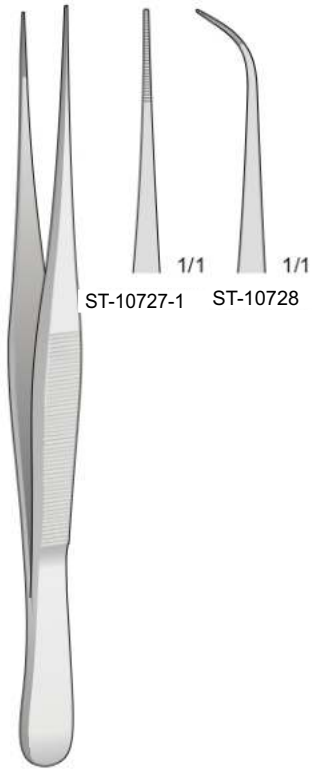
ST-10724



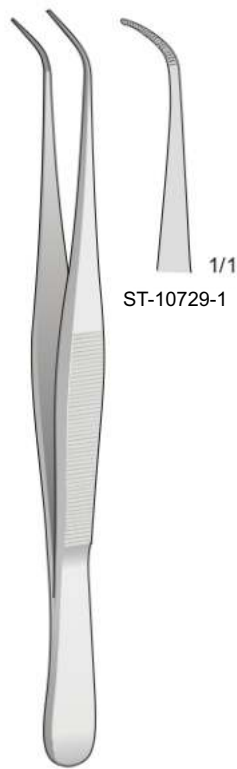
ST-10725
115 mm



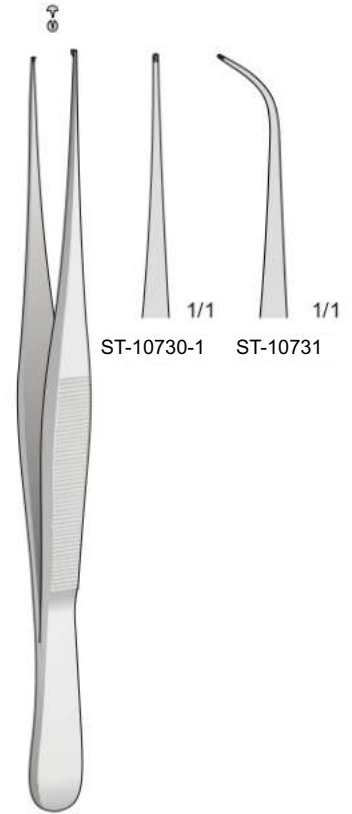
ST-10726
115 mm



ST-10727
100 mm



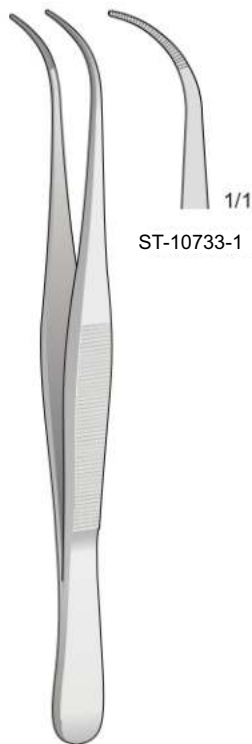
ST-10729
100 mm



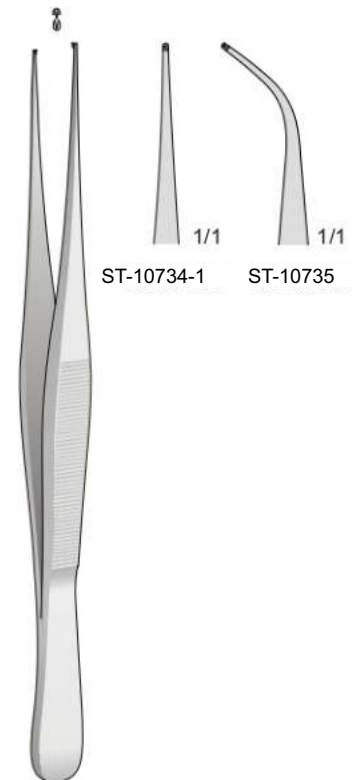
ST-10730
100 mm



ST-10732
110 mm



ST-10733
110 mm



ST-10734
110 mm



GRAEFE
ST-10736
100 mm



1/1
ST-10736-1



1/1
ST-10736-2



1/1
ST-10736-3



GRAEFE
ST-10737
100 mm



1/1
ST-10737-1



1/1
ST-10737-2



1/1
ST-10737-3



PERRY
ST-10738
125 mm

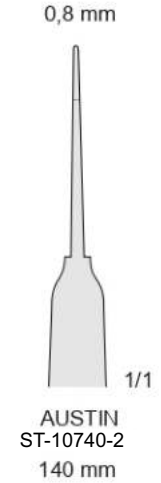


PERRY
ST-10739
125 mm



ST-10740

1x2 denti
0,2 mm
1/1
ST-10740-1
95 mm



AUSTIN
ST-10740-2
140 mm



ST-10741
130 mm



SEMKEN
ST-10742
130 mm



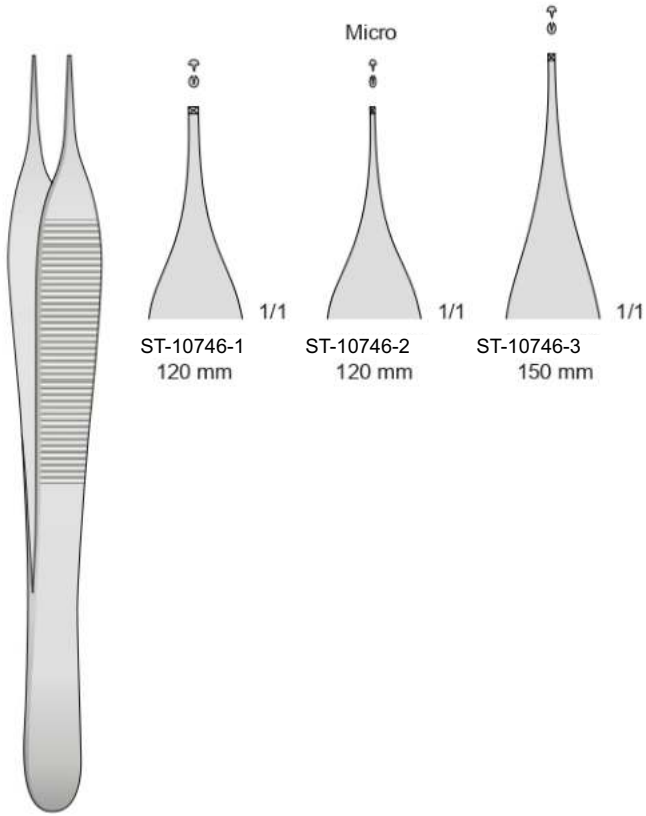
SEMKEN
ST-10743
130 mm



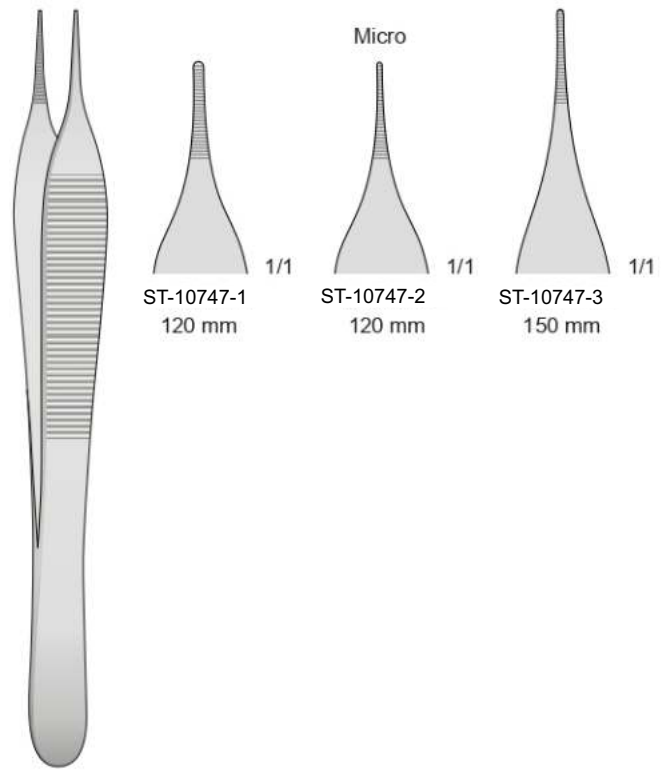
SEMKEN
ST-10744
130 mm



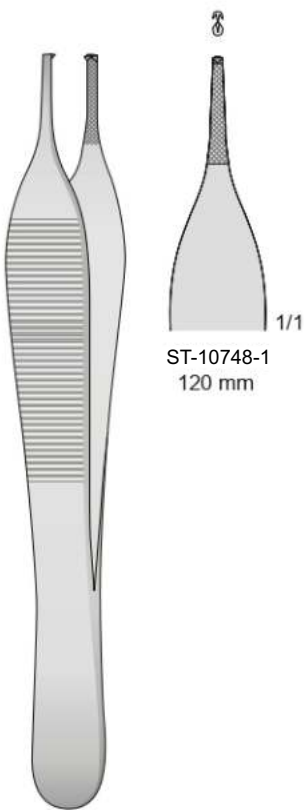
SEMKEN
ST-10745
130 mm



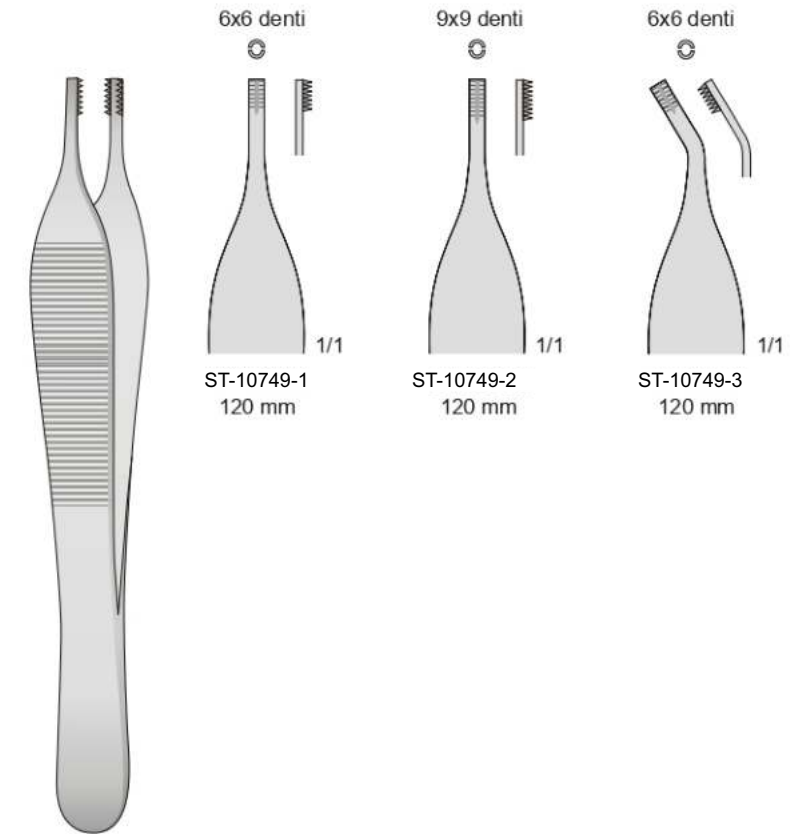
ADSON
ST-10746



ADSON
ST-10747



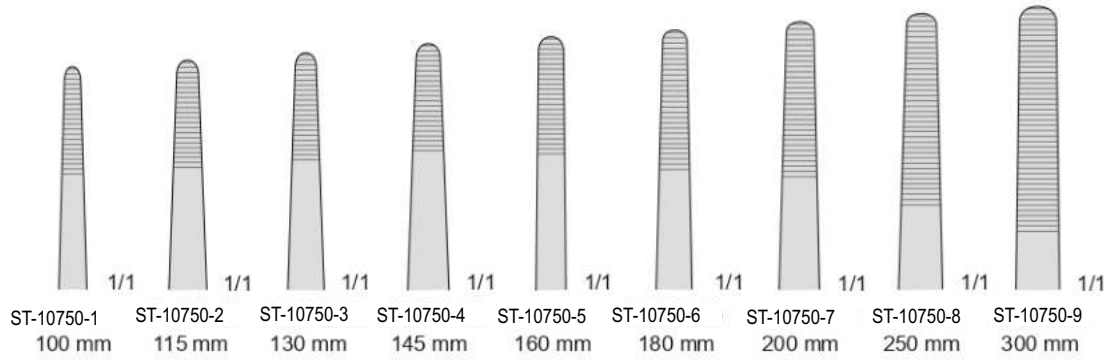
ADSON
ST-10748
120 mm



ADSON-BROWN
ST-10749
120 mm

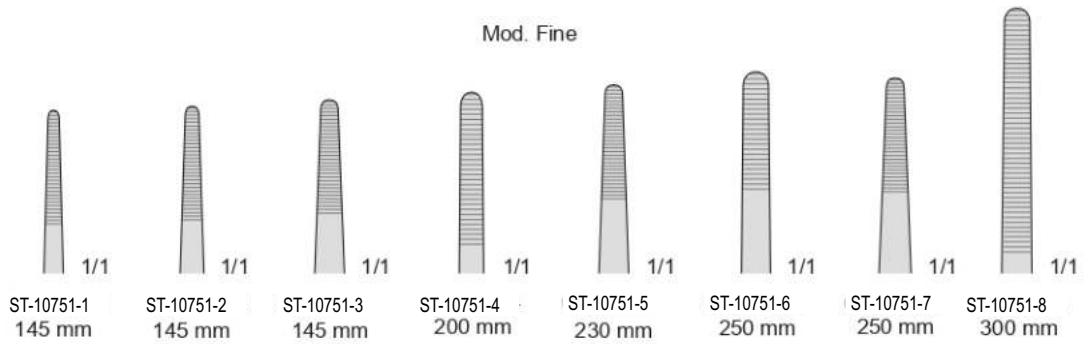


Standard



ST-10750

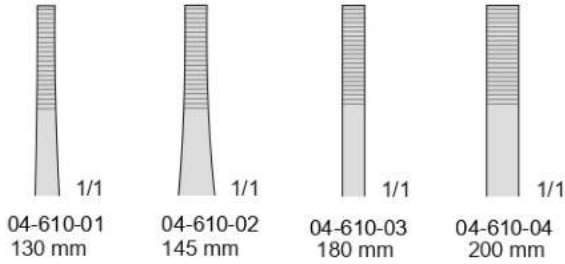
Mod. Fine



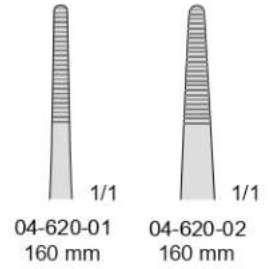
ST-10751



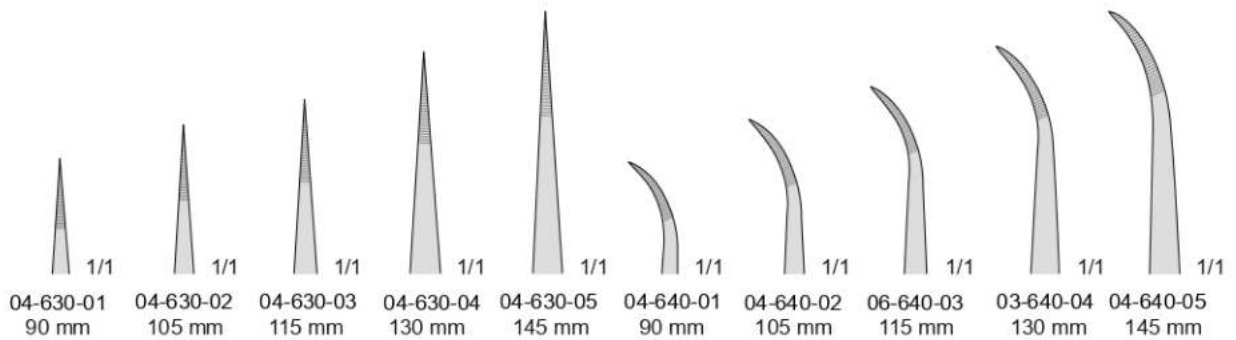
STILLE
04-610



04-620
160 mm



04-630/640

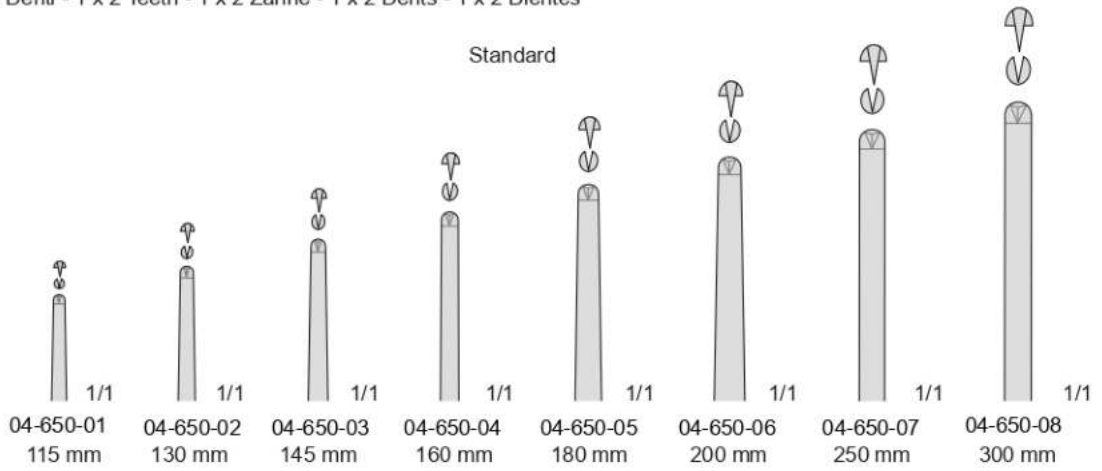




1 x 2 Denti - 1 x 2 Teeth - 1 x 2 Zähne - 1 x 2 Dents - 1 x 2 Dientes



Standard



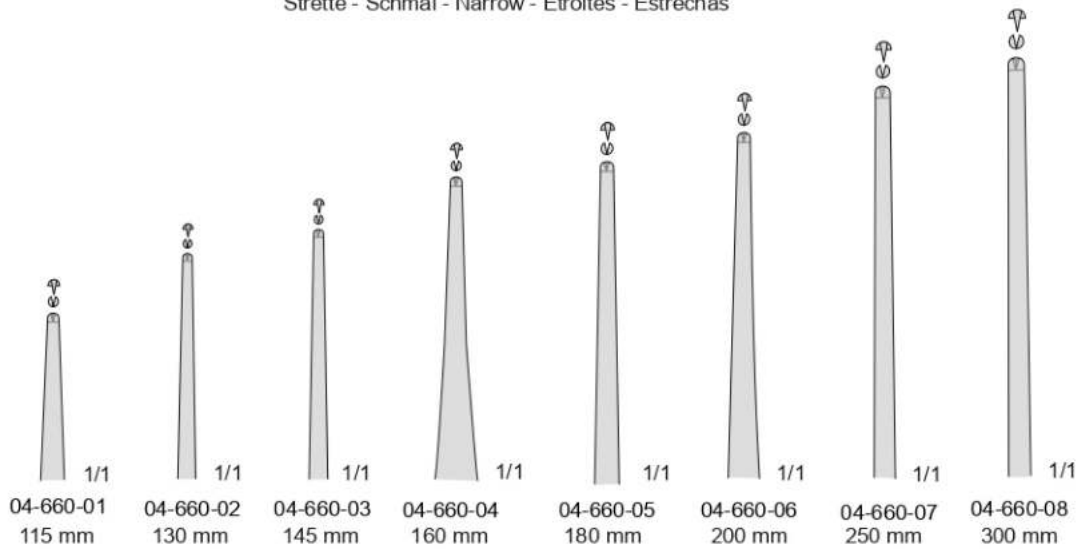
04-650



1 x 2 Denti - 1 x 2 Teeth - 1 x 2 Zähne - 1 x 2 Dents - 1 x 2 Dientes

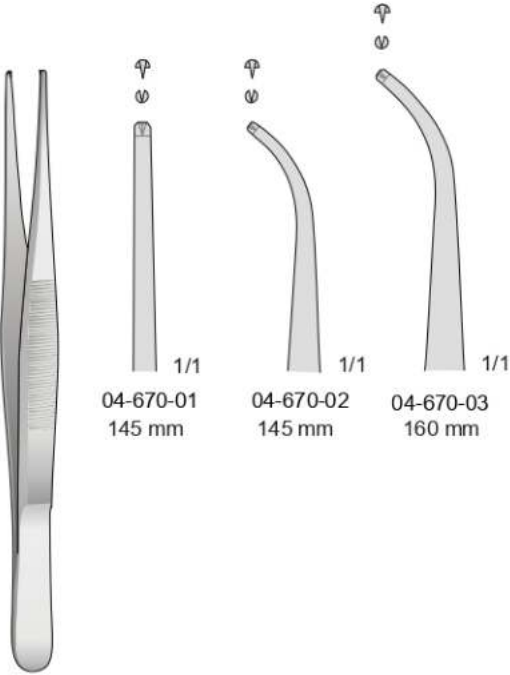


Strette - Schmal - Narrow - Étroites - Estrechas

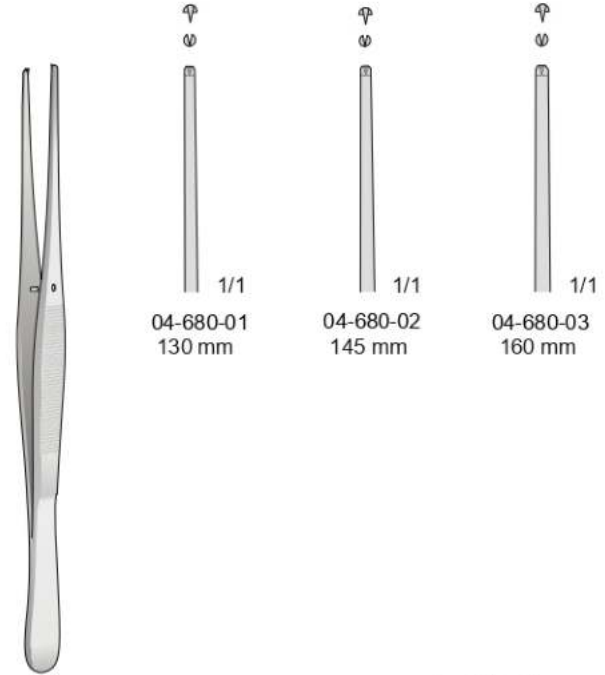


04-660

Strette - Schmal - Narrow - Étroites - Estrechas

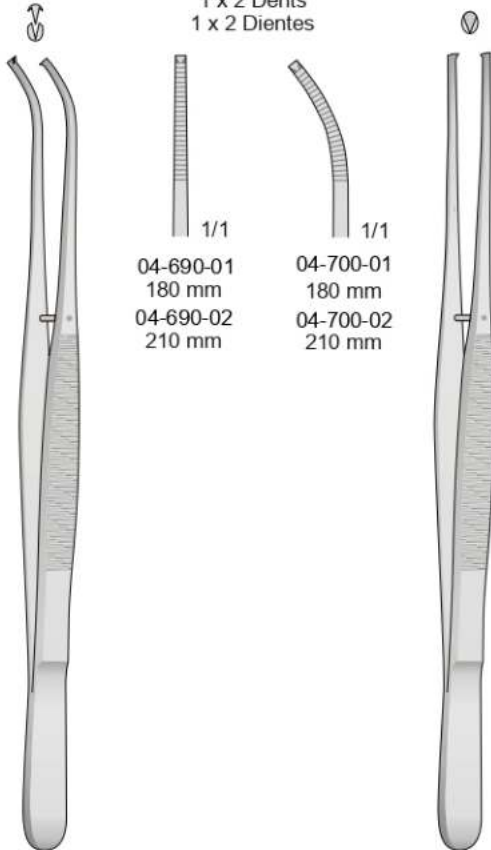


Fine - Delicate - Fein - Fines - Finas



04-670

1 x 2 Denti
1 x 2 Teeth
1 x 2 Zähne
1 x 2 Dents
1 x 2 Dientes

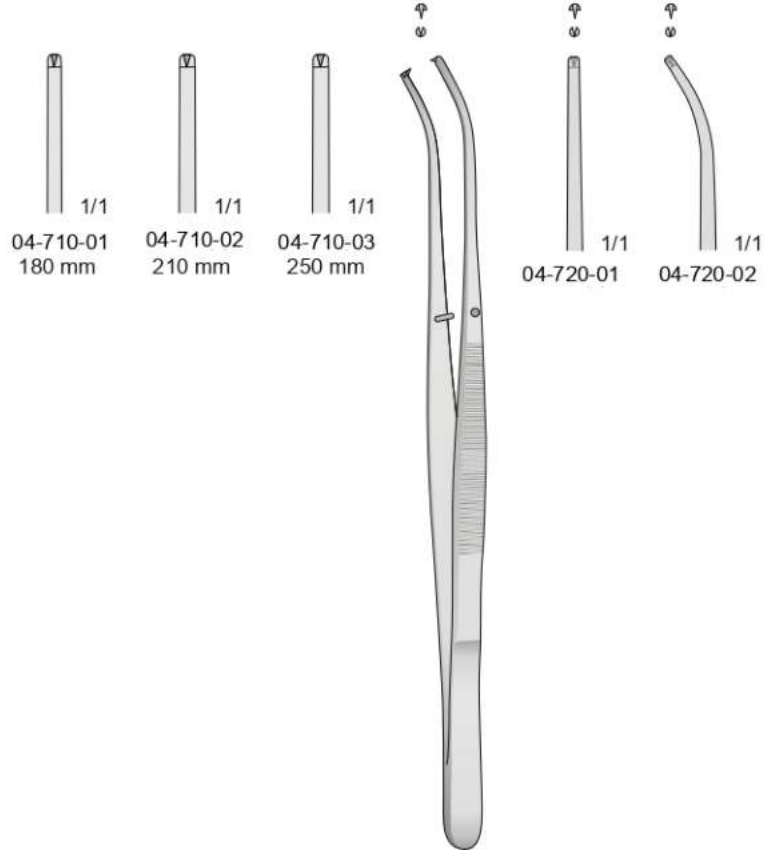


POTTS-SMITH
04-690

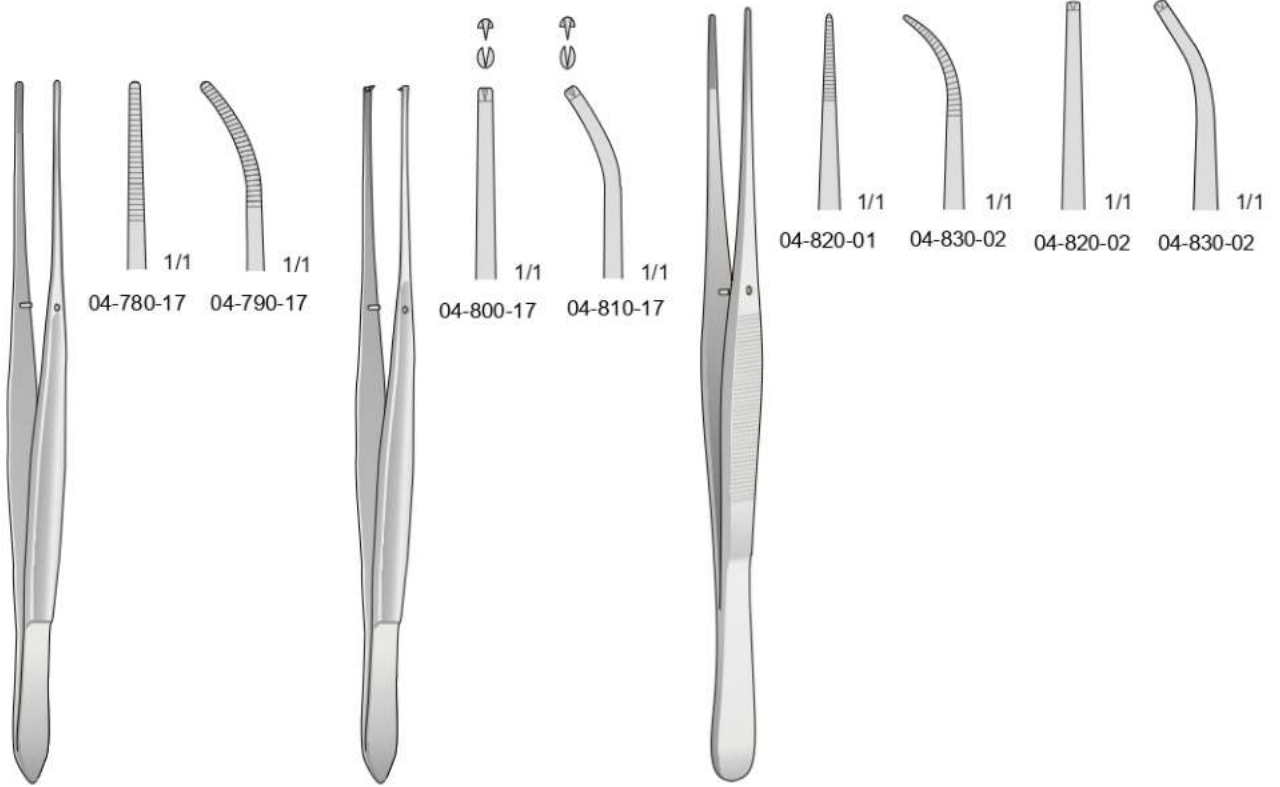
POTTS-SMITH
04-710

04-680

1 x 2 Denti
1 x 2 Teeth
1 x 2 Zähne
1 x 2 Dents
1 x 2 Dientes



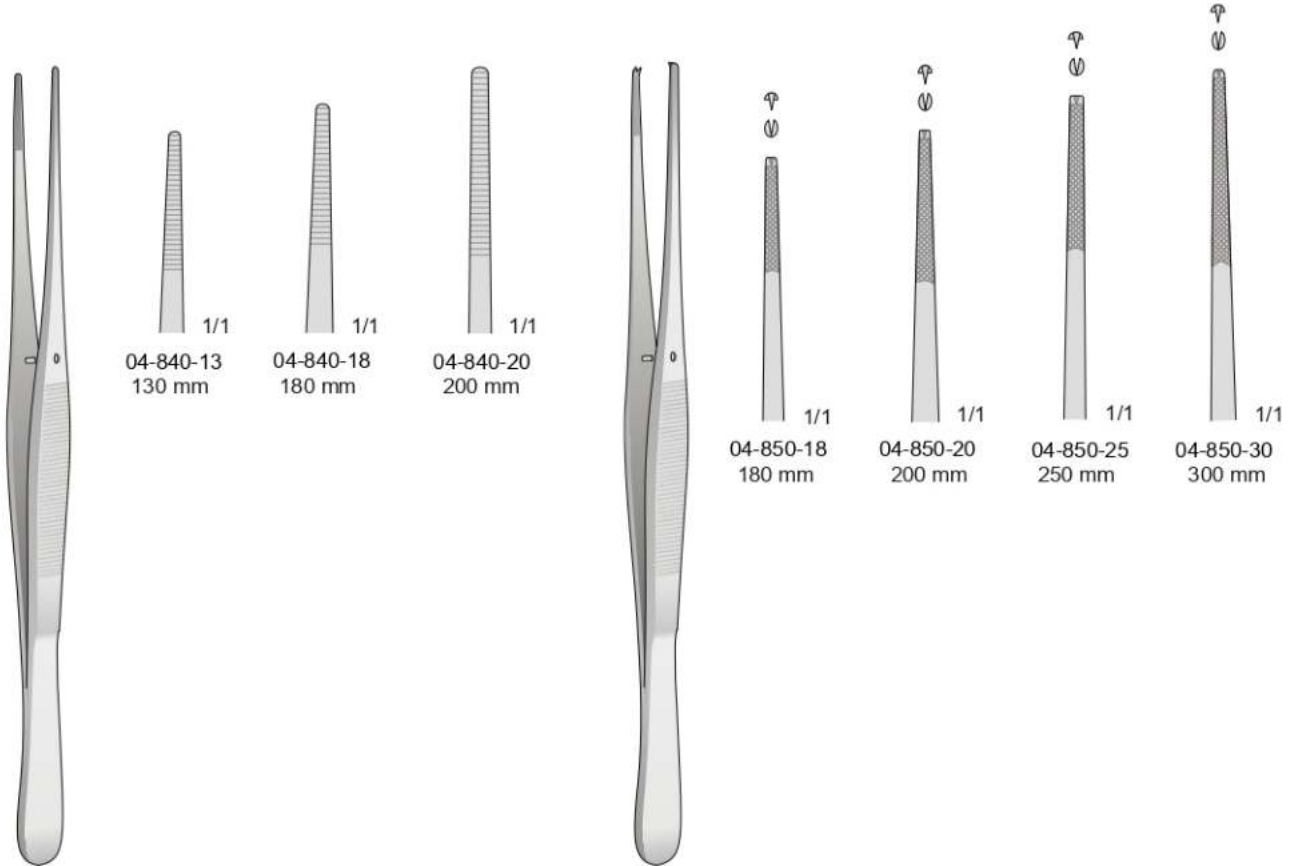
SEMKEN
04-720
150 mm



CUSHING
04-780
175 mm

CUSHING
04-800
175 mm

04-820
200 mm

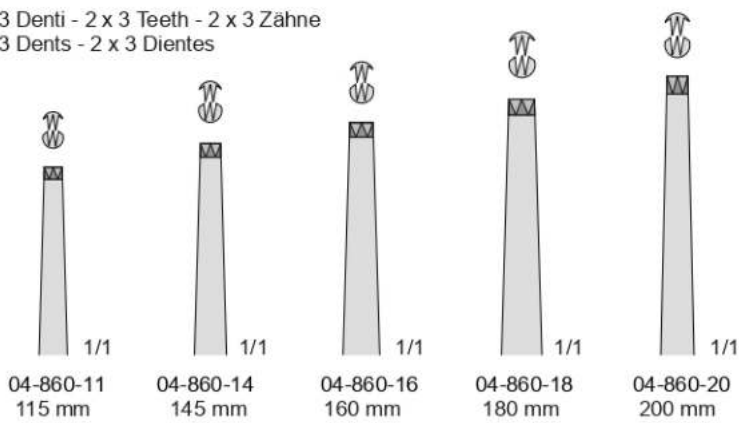


04-840

04-850



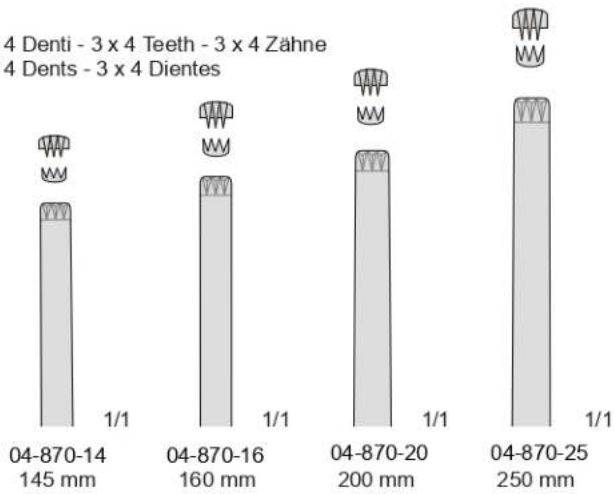
2 x 3 Denti - 2 x 3 Teeth - 2 x 3 Zähne
2 x 3 Dents - 2 x 3 Dientes



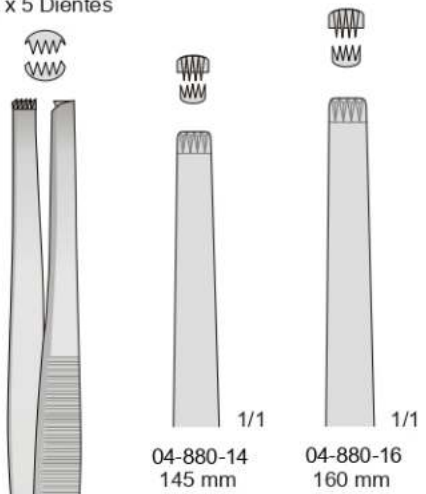
04-860

4 x 5 Denti
4 x 5 Teeth
4 x 5 Zähne
4 x 5 Dents
4 x 5 Dientes

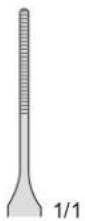
3 x 4 Denti - 3 x 4 Teeth - 3 x 4 Zähne
3 x 4 Dents - 3 x 4 Dientes



04-870



04-880



1/1

GERALD
04-890-18
180 mm



1/1

GERALD
04-900-18
180 mm



1/1

GERALD
04-910-18
180 mm



1/1

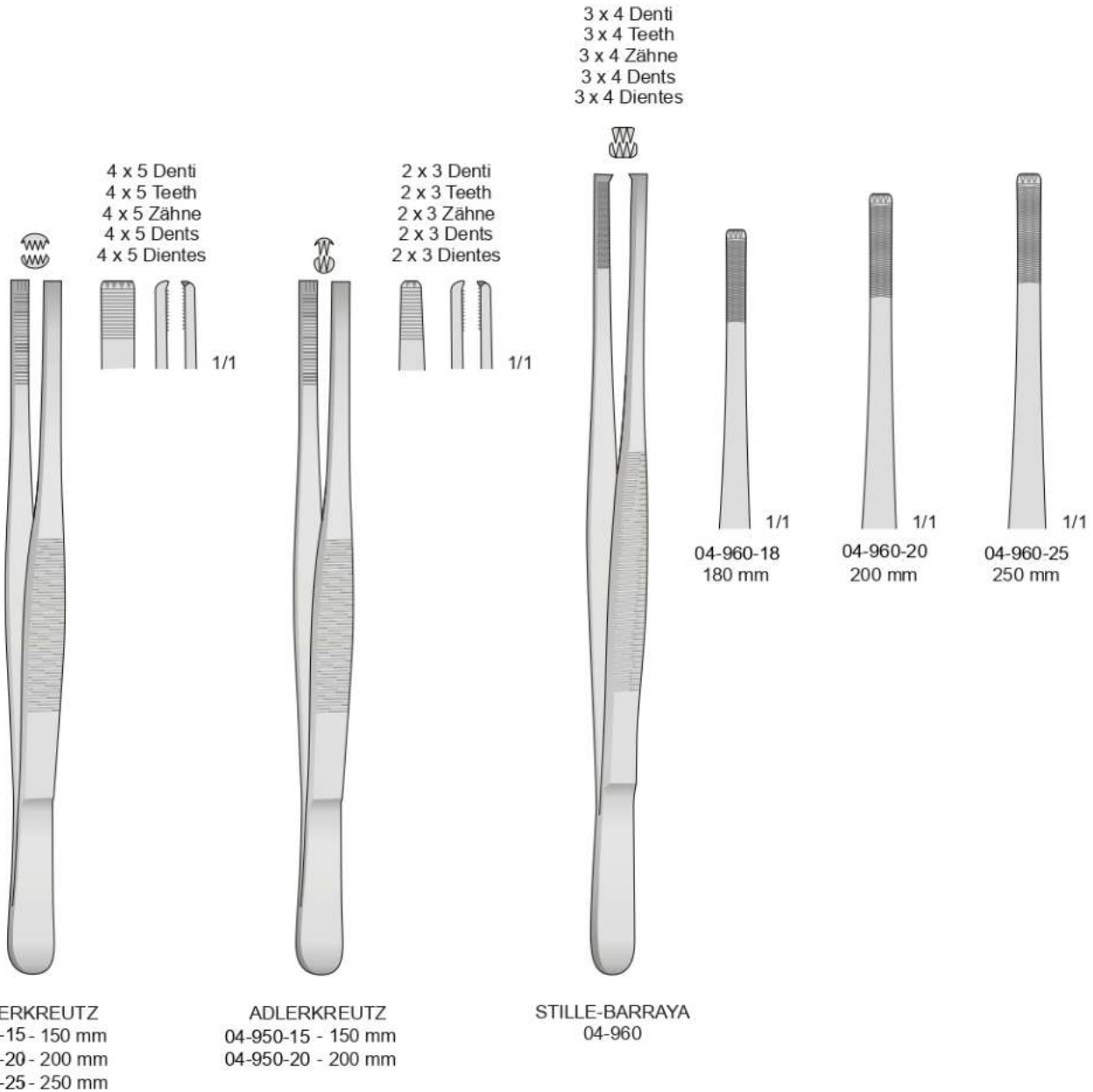
GERALD
04-920-18
180 mm

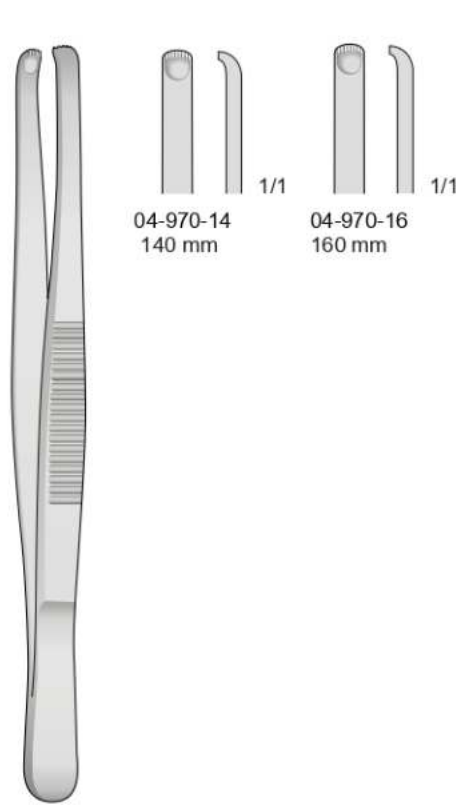


1/1

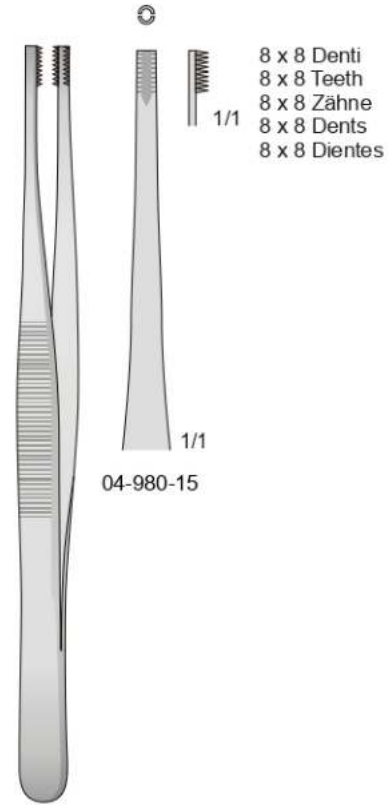
GERALD-BROWN
04-930-18
180 mm

Pinzette per vasi e per tumori
Pincers vasculaires et pour tumeurs

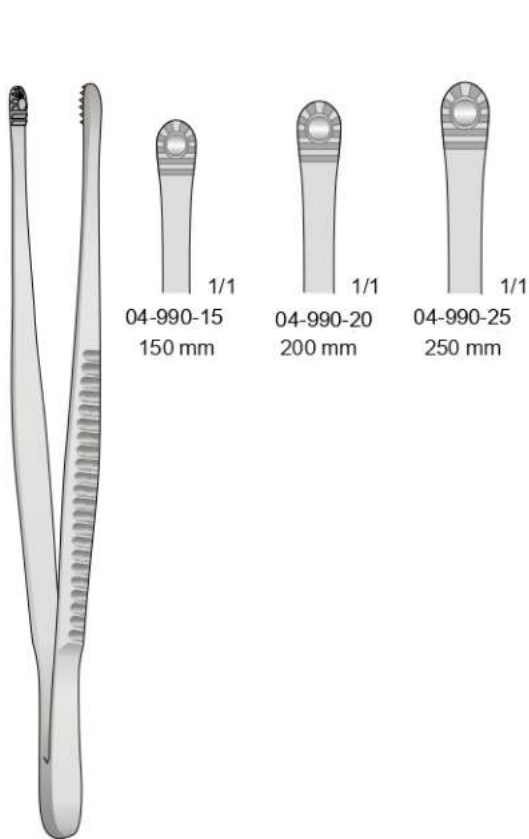




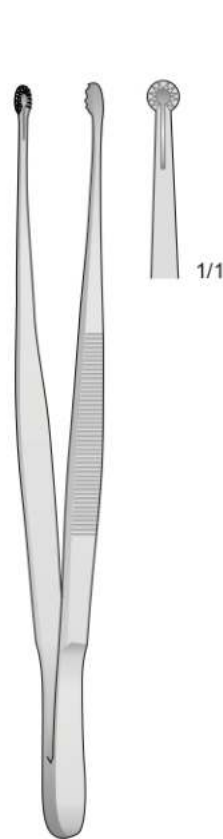
DURANTE
04-970



BROWN
04-980
150 mm



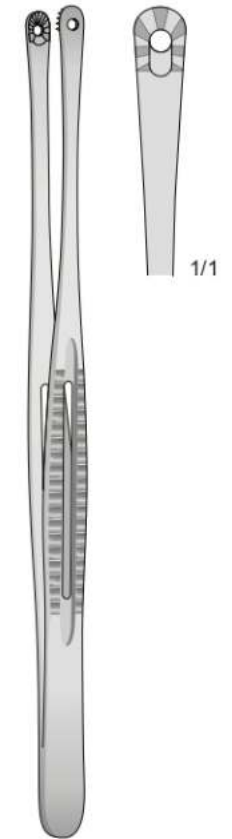
RUSSIAN
04-990



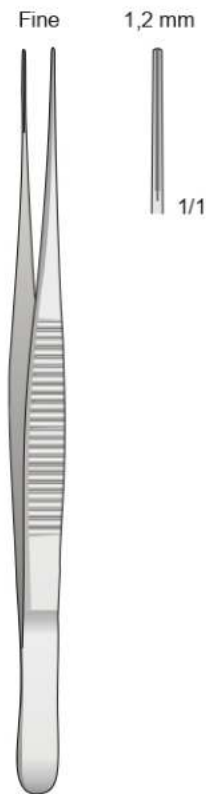
SELMAN
04-1000-15
150 mm



SINGLEY-TUTTLE
04-1010-23
230 mm



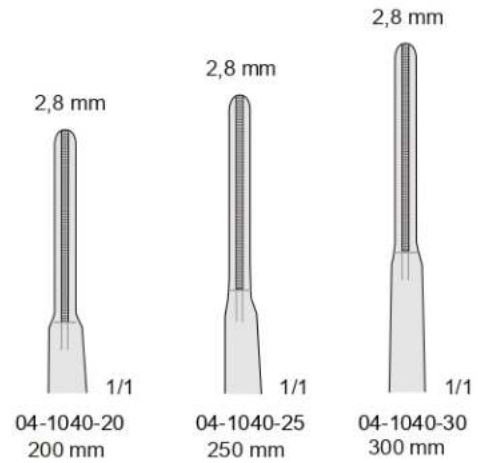
MAYO-RUSSIAN
04-1020-23
230 mm



DE BAKEY
04-1030-19
195 mm



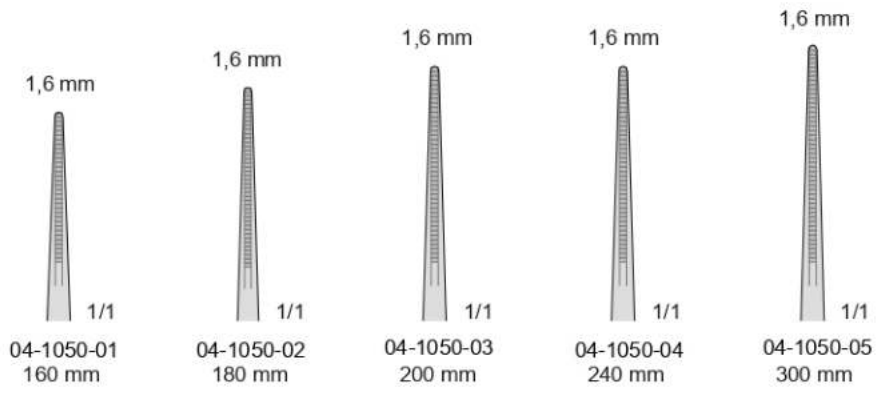
DE BAKEY
04-1040



04-1040-20
200 mm

04-1040-25
250 mm

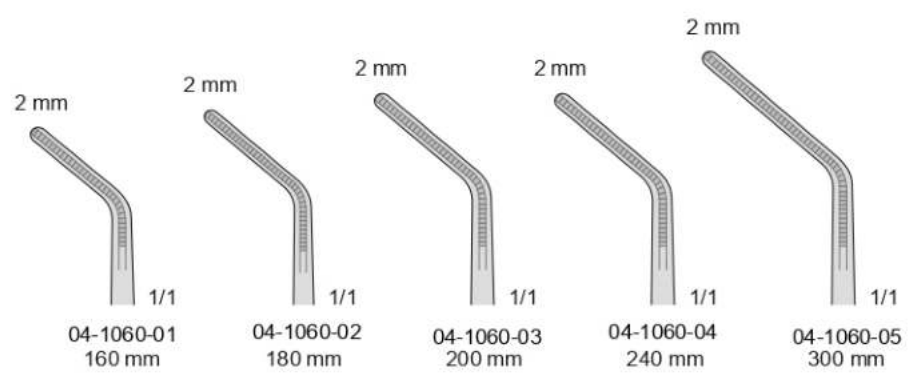
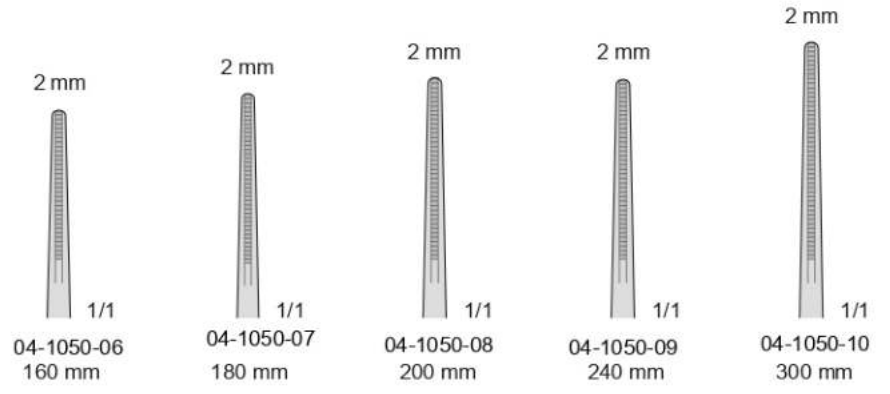
04-1040-30
300 mm



Pinzette atraumatiche
Non-traumatic vascular tissue forceps
Atraumatische pinzetten
Pincés atraumáticas
Pinzas atraumaticas



DE BAKEY
04-1050/1060

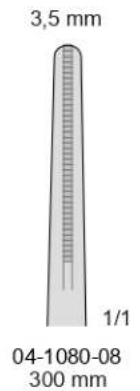
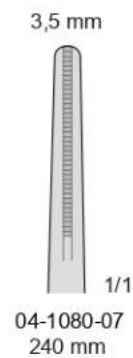
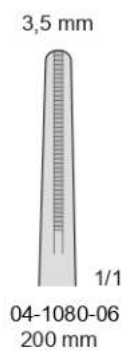
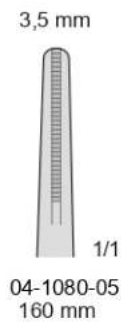
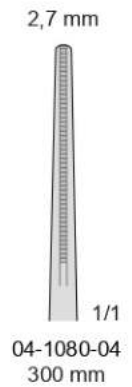
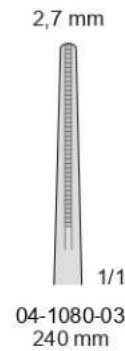
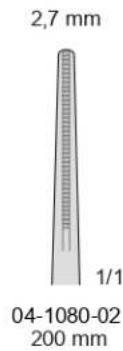
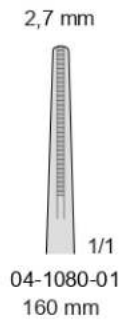




Pinzette atraumatiche
Atraumatische pinzetten
Atraumatic vascular tissue forceps
Pincés atraumatiques
Pinzas atraumaticas



DE BAKEY
04-1070/1080





Pinze da Fissazione-oftalmica - Fixier und fasspinzetten
Fixation and Grasping forceps - Pinzas de fijación y de aprehensión

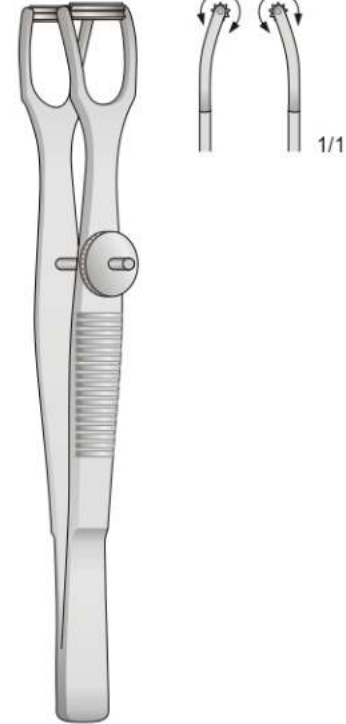


GRAEFE
04-1090-11
110 mm

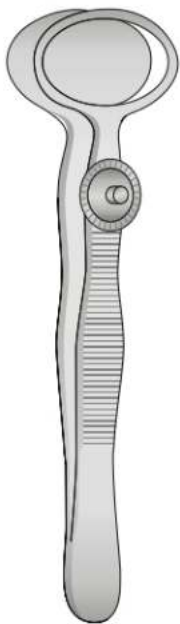


GRAEFE
04-1100-11
110 mm

Pinzetta-Columella
con stop



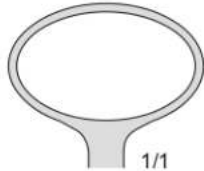
COTTLE
04-1110-10
100 mm



DESMARRES
04-1120
90 mm



1/1
04-1120-20
20 mm



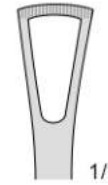
1/1
04-1020-26
26 mm



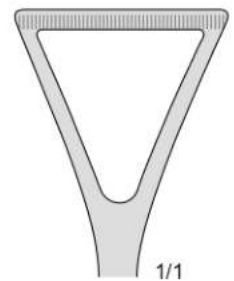
1/1
04-1120-31
31 mm



DUVAL
04-1130



1/1
04-1130-14
140 mm



1/1
04-1130-20
200 mm

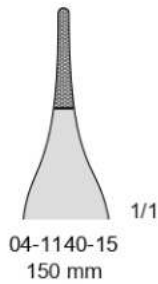
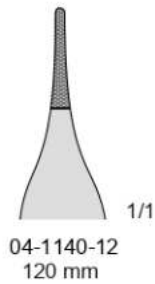
Pinze intestinali
Intestinal forceps
Darmpinzetten
Pincés pour préhension de l'intestin
Pinzas intestinales



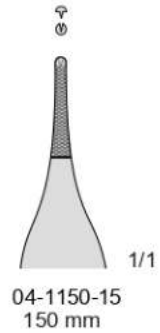
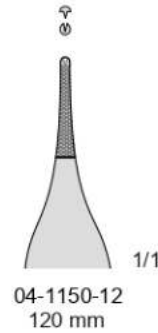
Con punta al carburo di tungsteno - Tungsten-carbide forceps
Mit hartmetalleinsätzen - Avec plaquettes en carbure de tungstène - Pinzas con tungsteno



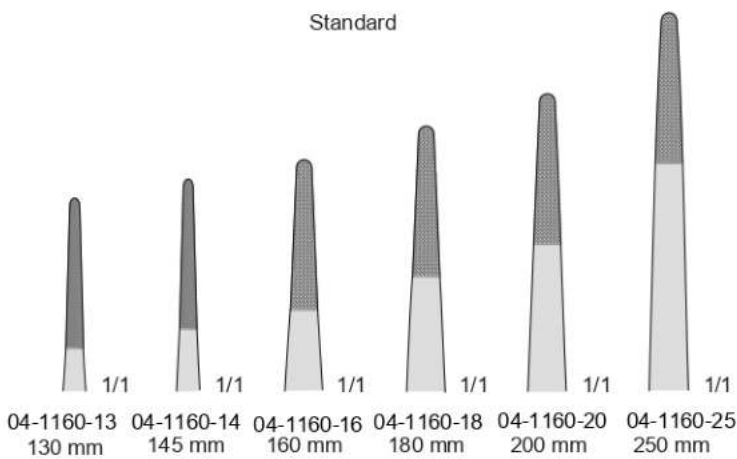
ADSON
04-1140



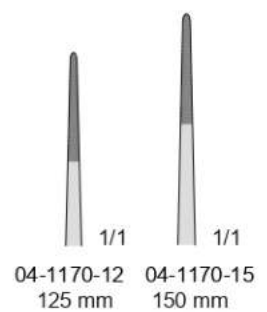
ADSON
04-1150

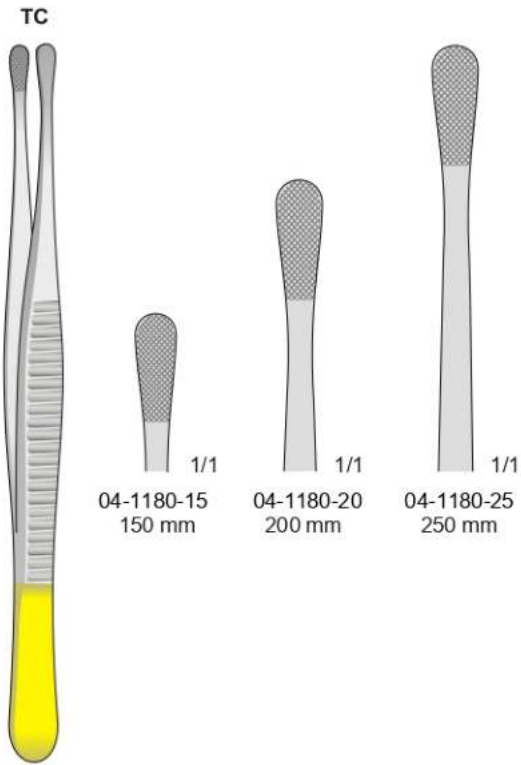


04-1160

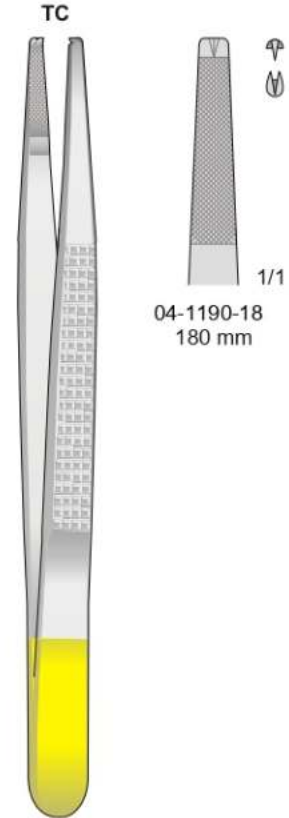


SEMKEN
04-1170

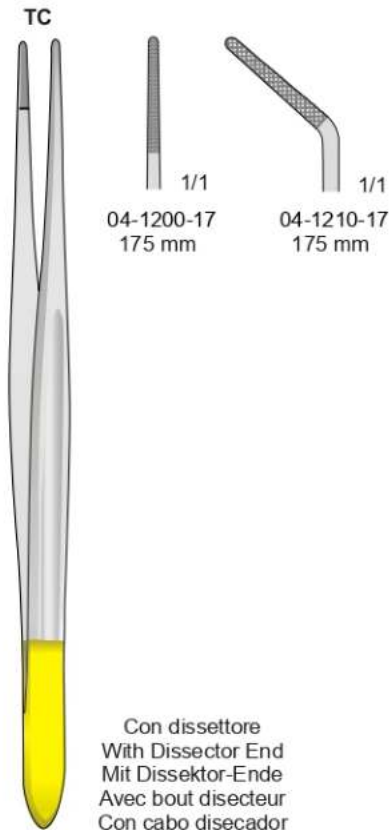




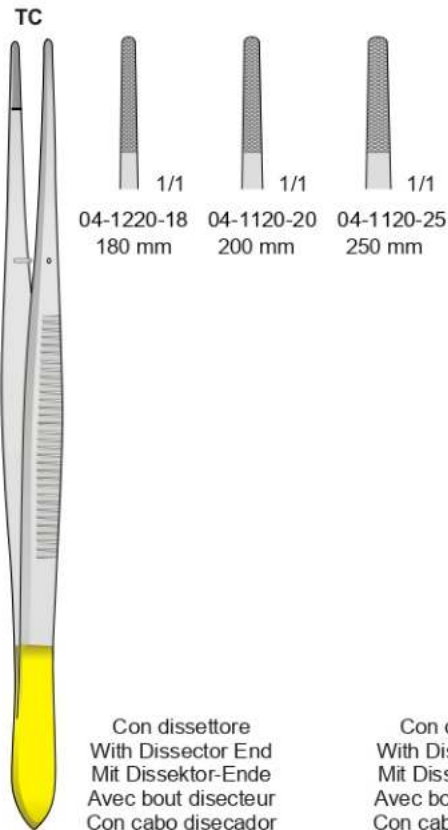
WANGENSTEEN
04-1180



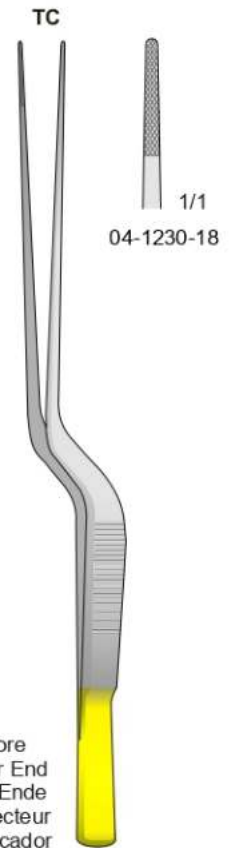
BONNEY
04-1190
180 mm



CUSHING
04-1200
175 mm



POTTS-SMITH
04-1220



TAYLOR
04-1230
185 mm

Con punta al carburo di tungsteno
Tungsten-carbide forceps
Mit hartmetalleinsätzen
Avec plaquettes en carbure de tungstène
Pinzas con tungsteno

TC

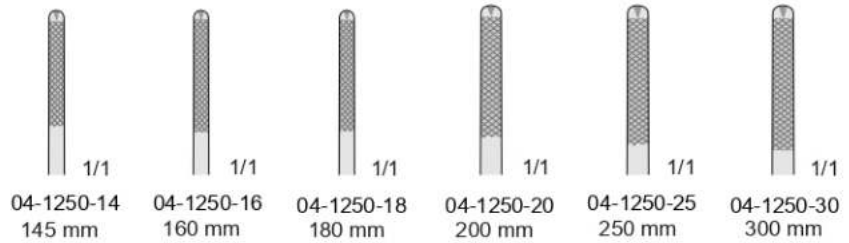


DE BAKEY
04-1240-18
180 mm

TC



04-1250

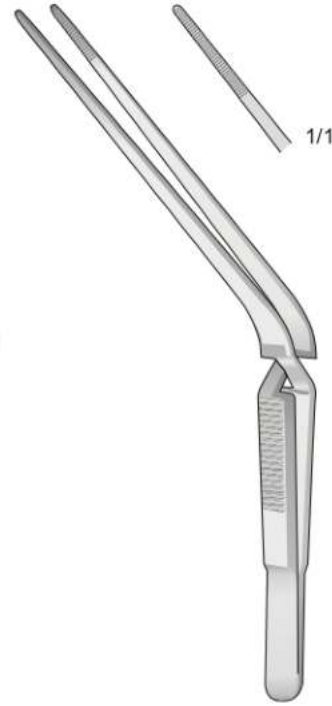




TROELTSCH
04-1260-11
110 mm



TROELTSCH
04-1270-11
110 mm



TROELTSCH
04-1280-13
130 mm



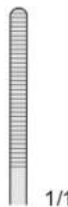
LUCAE
04-1290-14
140 mm



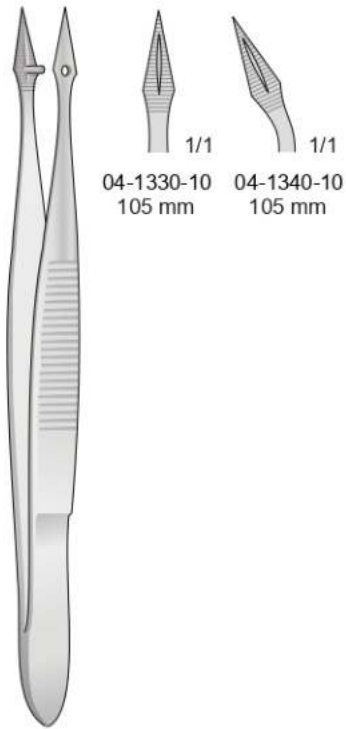
LUCAE
04-1300-14
140 mm



JANSEN
04-1310-16
160 mm



GRÜENWALD
04-1320-20
200 mm



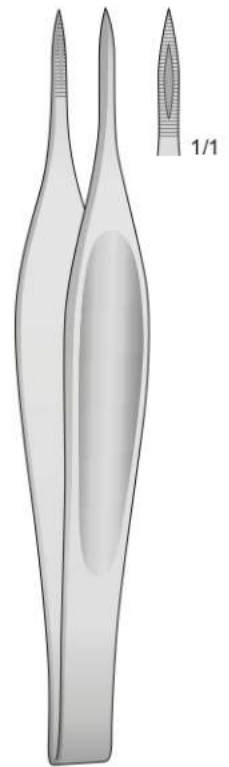
HUNTER
04-1330



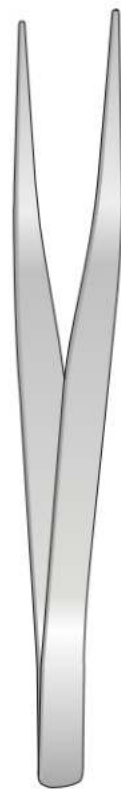
FEICHENFELD
04-1350-07
75 mm



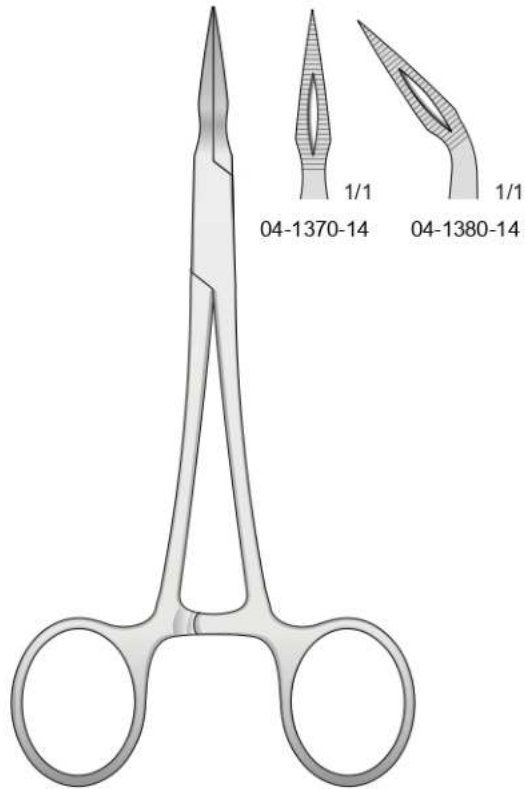
FEICHENFELD
04-1350-09
90 mm



FEICHENFELD
04-1350-11
115 mm



04-1360-15
150 mm



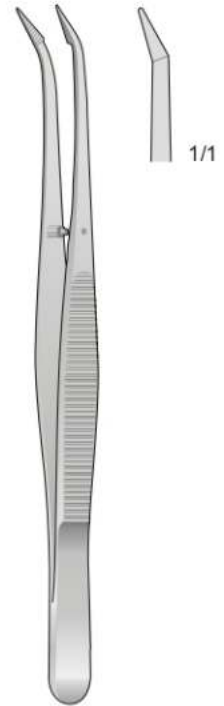
STIEGLITZ
04-1370
140 mm



KÜHNE
04-1390-10
105 mm



LITTAUER
04-1400-08
85 mm



BARRAQUER
04-1410-10
105 mm



04-1420-09
90 mm



04-1430-09
90 mm



BERGH
04-1440-10
105 mm



BEER
04-1450-09
90 mm



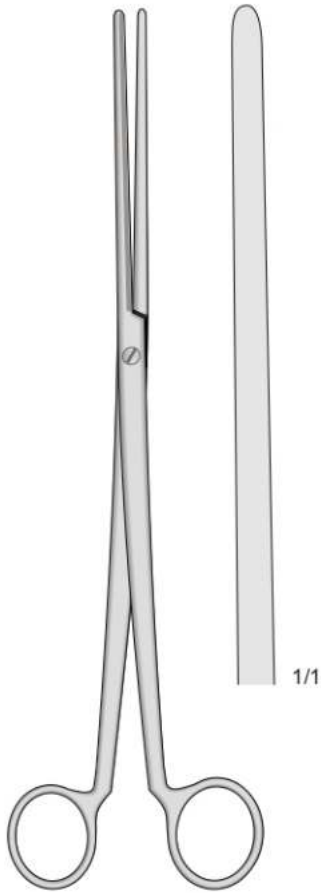
SAFE TOOL
MANUFACTURER & EXPORTER

Hemostatic Forceps Towel Clamps

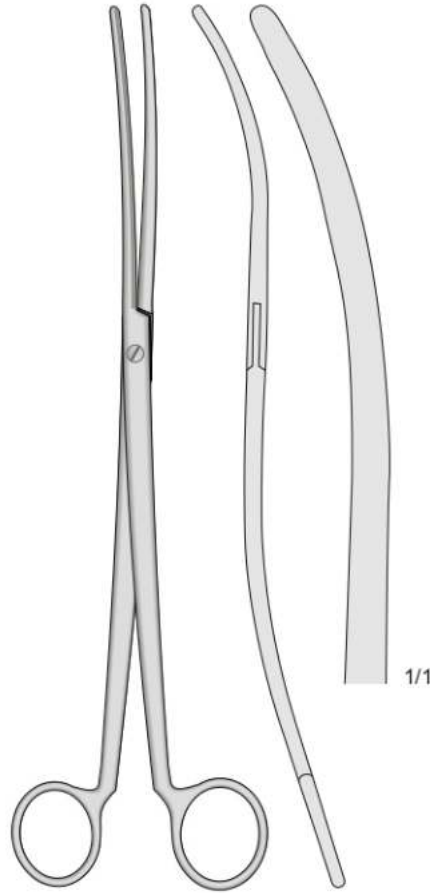


www.safetool.com.pk

***Surgical
Instruments***

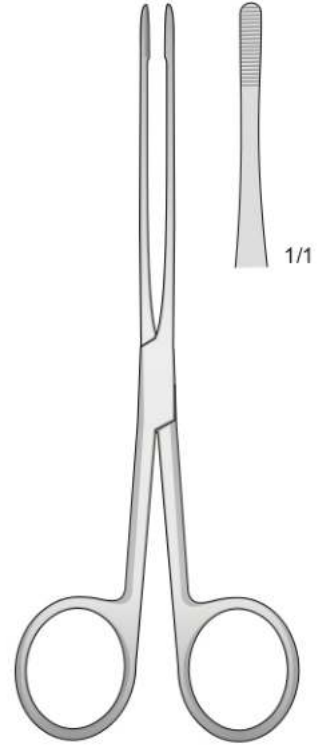


COLLIN
ST-7601
260 mm

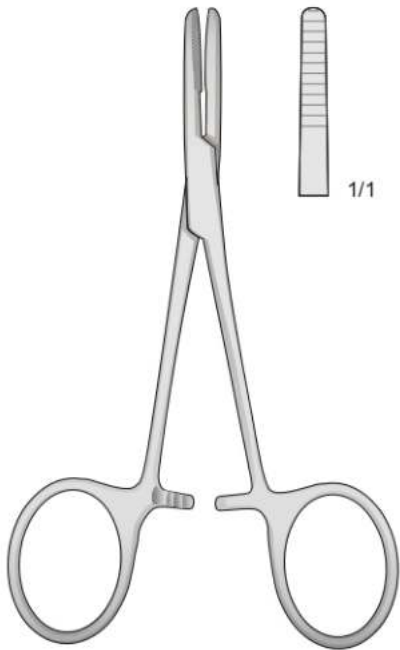


COLLIN
ST-7602
260 mm

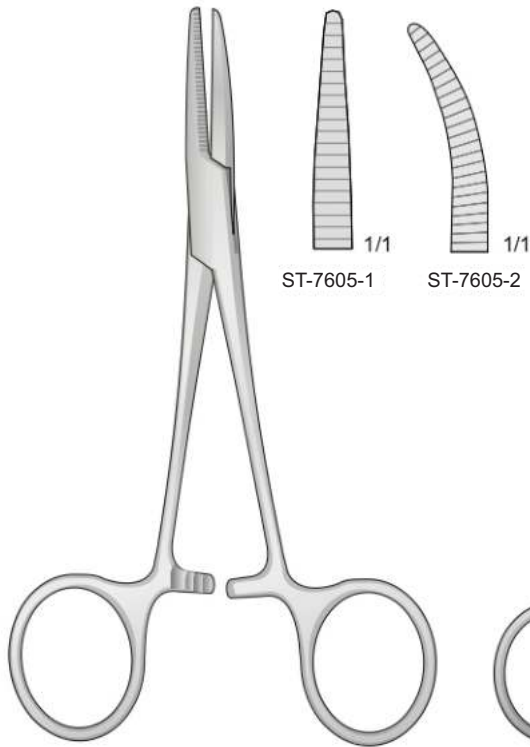
Pinze Sinus
Sinus forceps
Sinus klemmen
Pinces à Sinus
Pinzas para seno



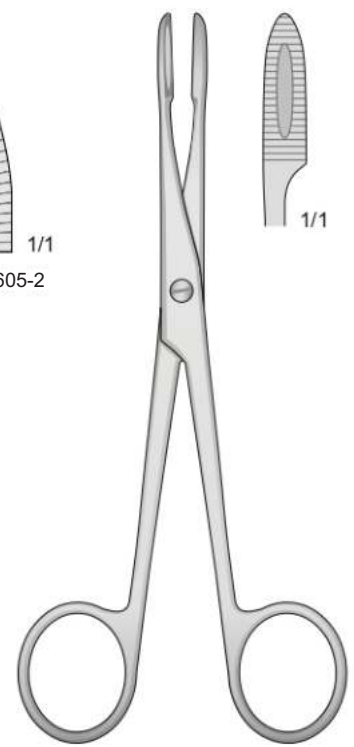
LISTER
ST-7603
150 mm



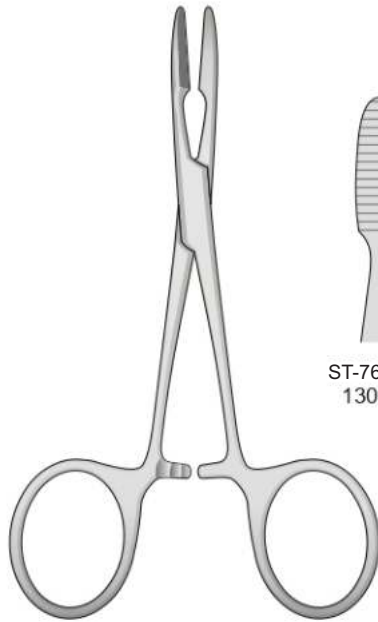
TERRIER
ST-7604
130 mm



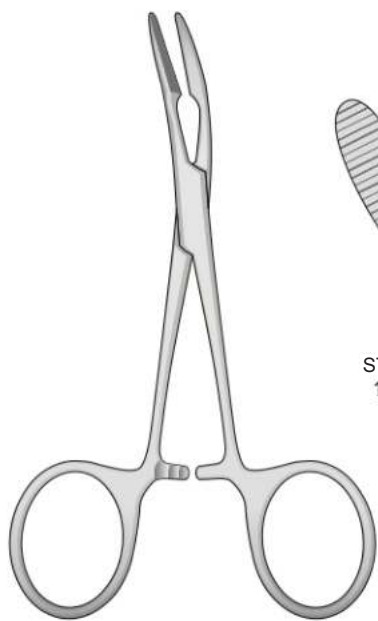
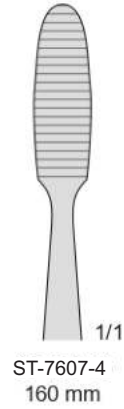
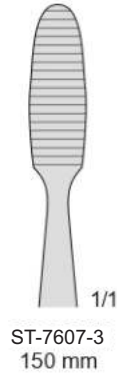
JONES
ST-7605
150 mm



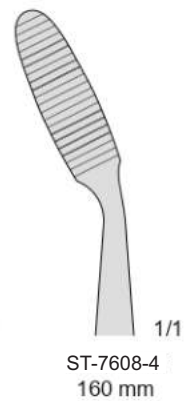
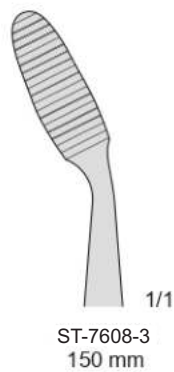
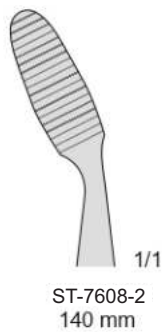
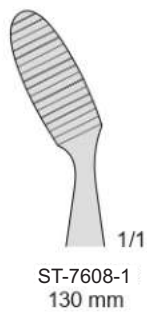
GROSS
ST-7606-1 - 130 mm
ST-7606-2 - 160 mm

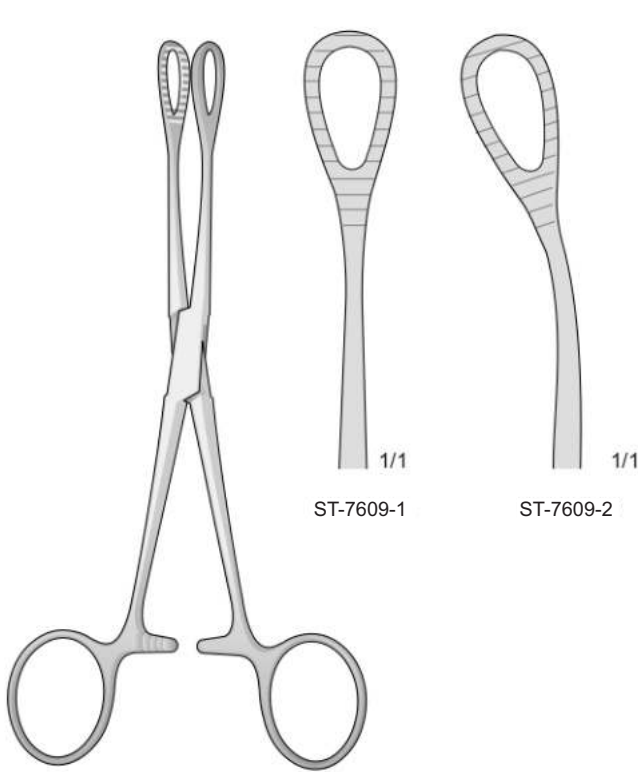


PEAN-MURPHY
ST-7607



PEAN-MURPHY
ST-7608

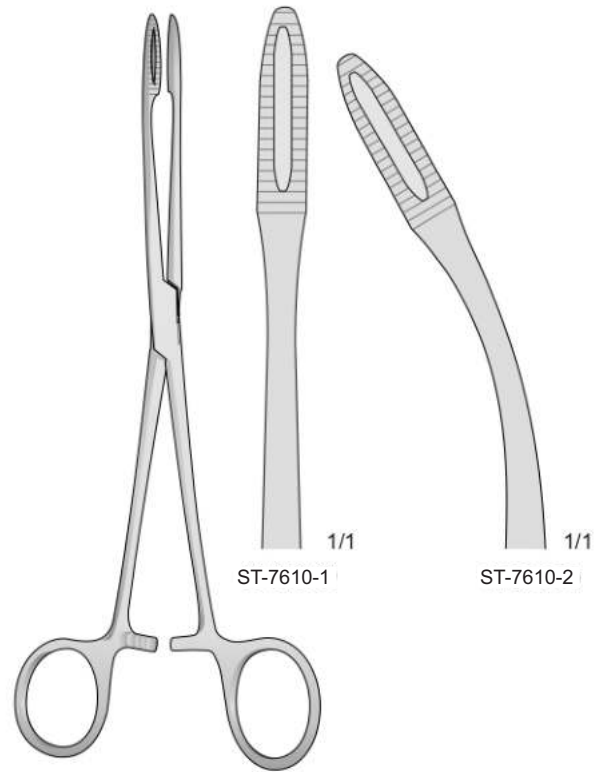




ST-7609-1 1/1

ST-7609-2 1/1

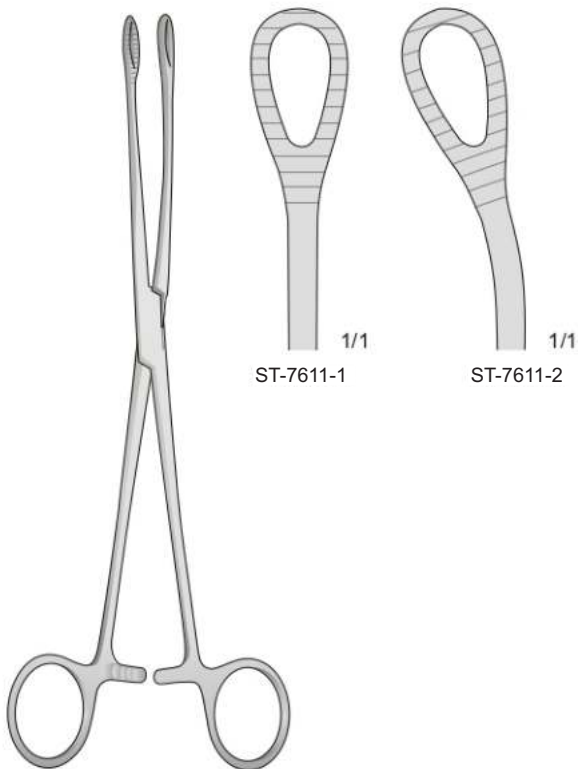
FOERSTER-BALLENGER
ST-7609
180 mm



ST-7610-1 1/1

ST-7610-2 1/1

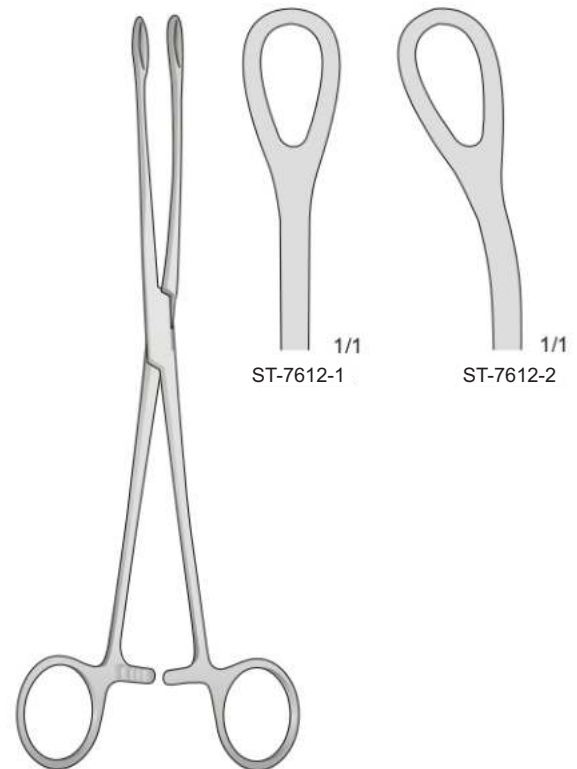
GROSS
ST-7610
200 mm



ST-7611-1 1/1

ST-7611-2 1/1

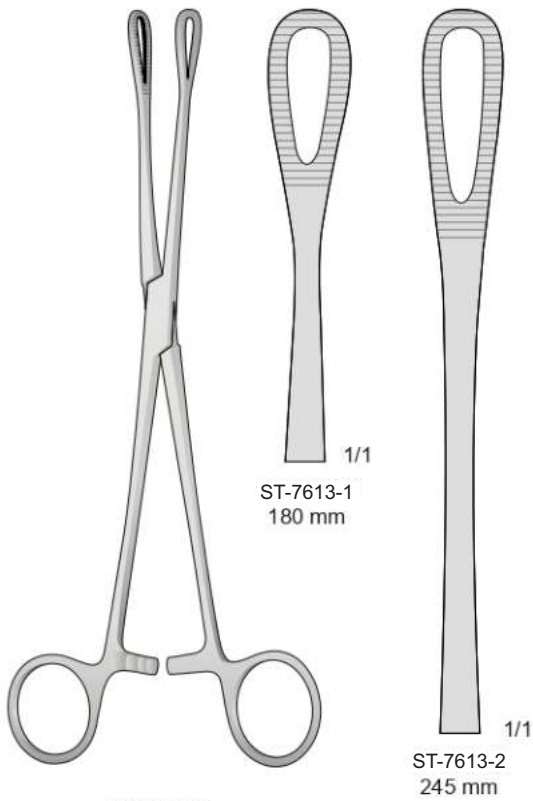
FOERSTER-BALLENGER
ST-7611
240 mm



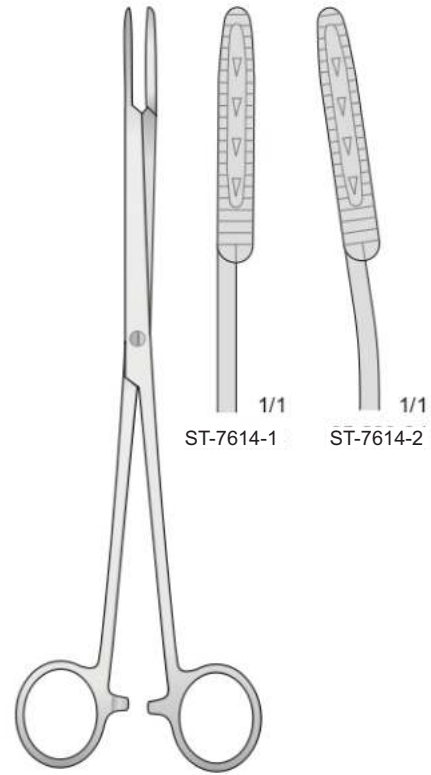
ST-7612-1 1/1

ST-7612-2 1/1

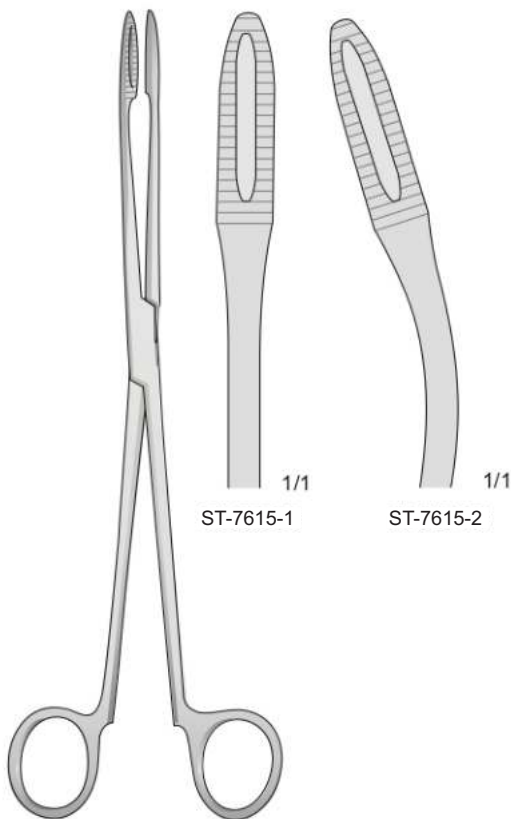
FOERSTER-BALLENGER
ST-7612
240 mm



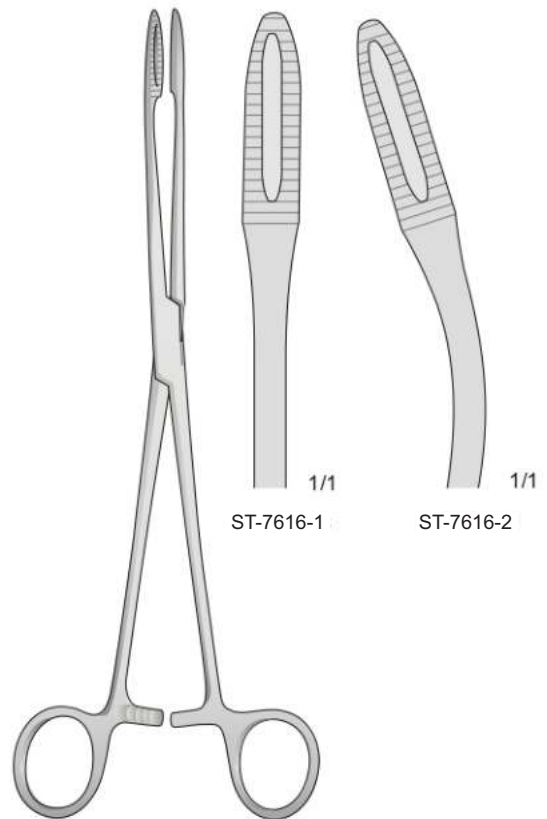
RAMPLEY
ST-7613



MAIER
ST-7614
245 mm

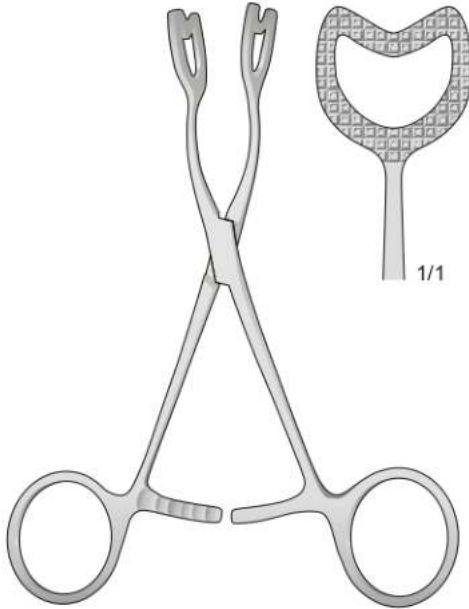


MAIER
ST-7615
265 mm

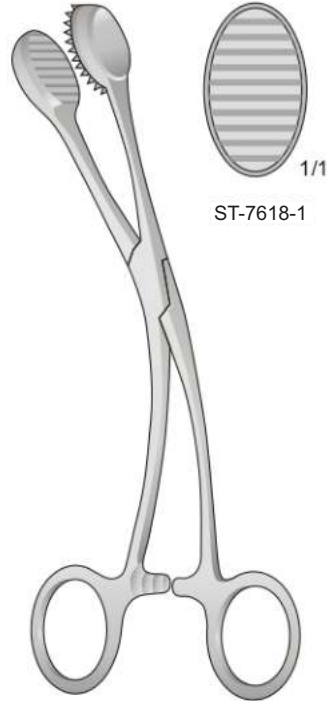


MAIER
ST-7616
265 mm

Gommini di ricambio 2 pezzi - Pair, Rubber jaws, only
 Paar, Gummipolster, Allein - Paire, mors en caotchouc, seuls
 Par, Bocas de goma, sueltas



ST-7617
140 mm

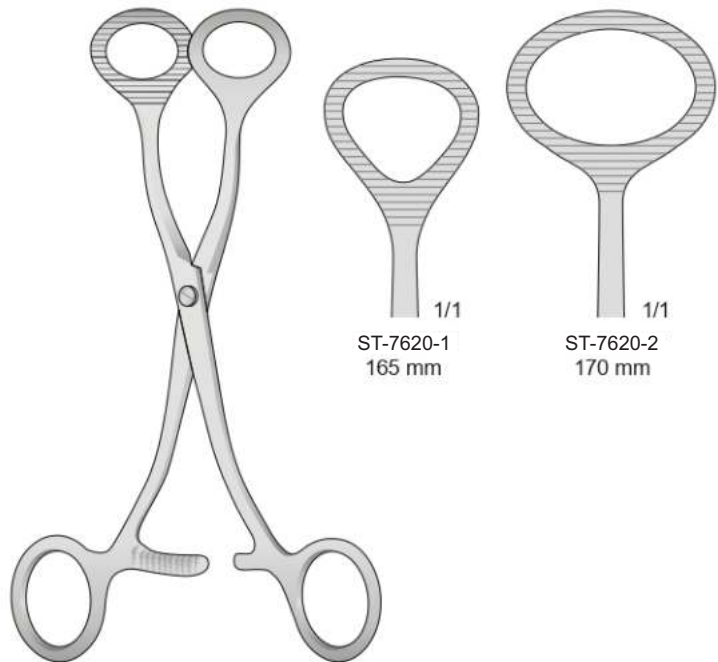


YOUNG
ST-7618
160 mm

Gommini di ricambio 2 pezzi - Pair, Rubber jaws, only
 Paar, Gummipolster, Allein - Paire, mors en caotchouc, seuls
 Par, Bocas de goma, sueltas



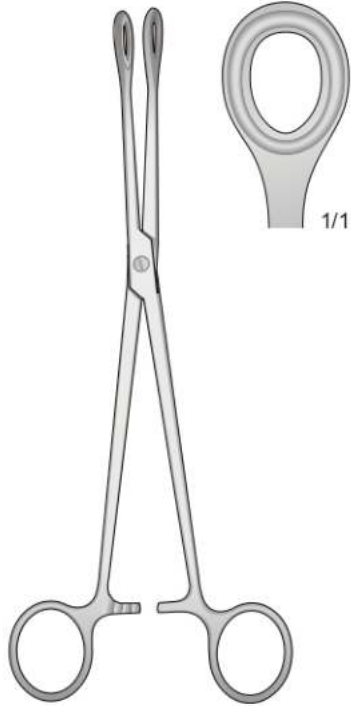
CHILD
ST-7619
240 mm



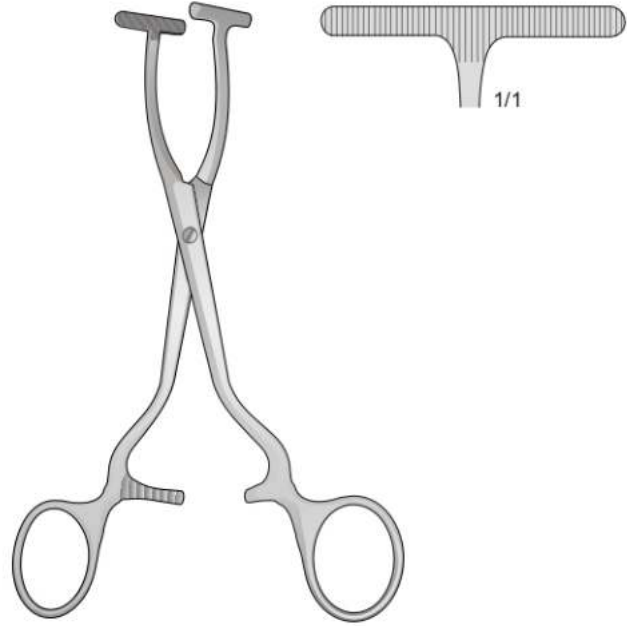
COLLIN
ST-7620



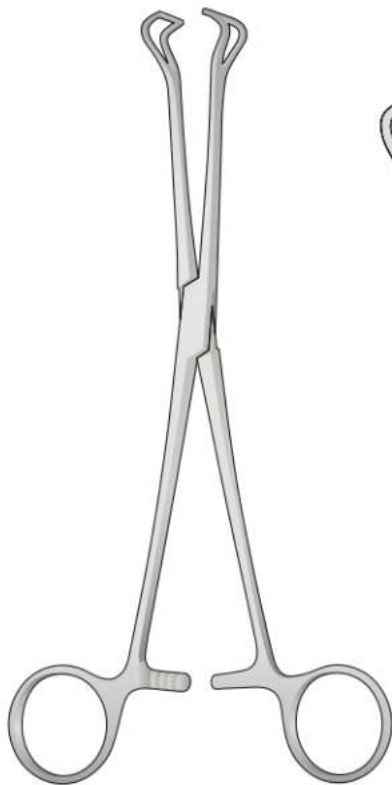
Pinza per batuffoli e tamponi
Cotton swab-sponge holding forceps
Tupfer-Schwammzangen - Pincés à tampons et éponges
Pinzas para tampones porta esponjas



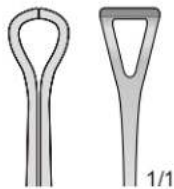
ST-7621
230 mm



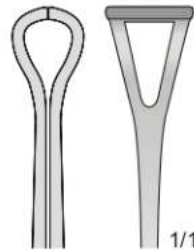
ST-7622
150 mm



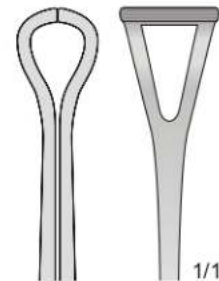
ST-7623
05-400



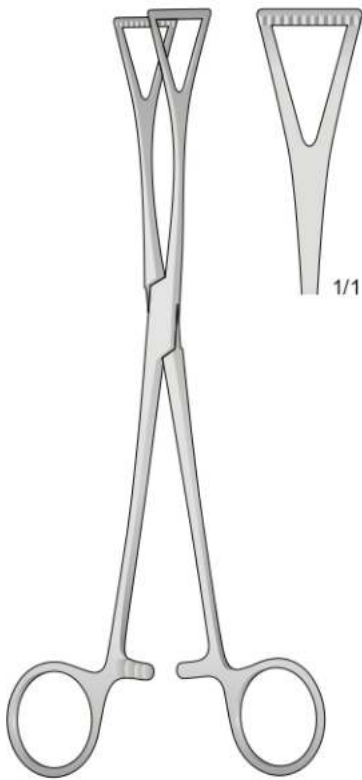
ST-7623-1
155 mm



ST-7623-2
180 mm

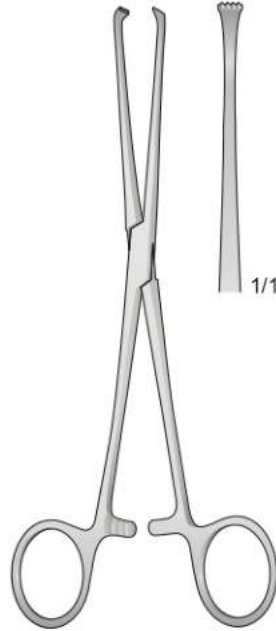


ST-7623-3
240 mm

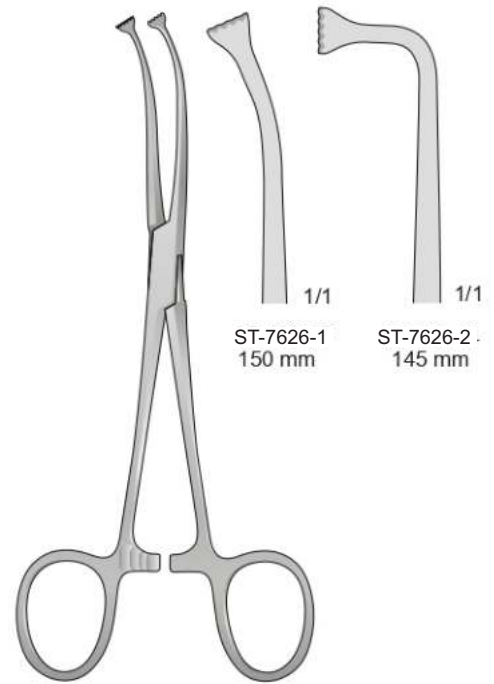


DUVAL
ST-7624
185 mm

4 x 5 denti
4 x 5 teeth
4 x 5 zähne
4 x 5 dents
4 x 5 dientes



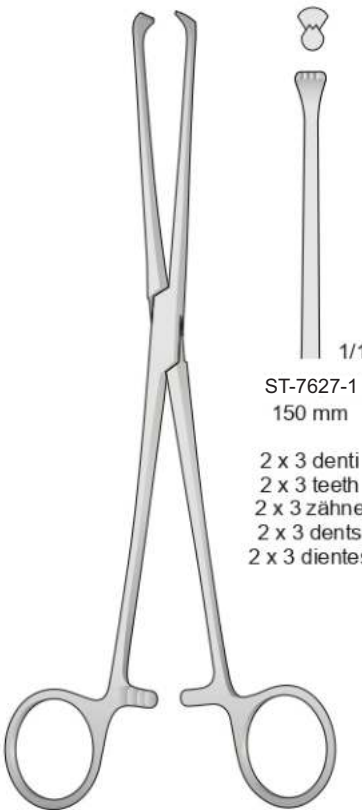
BABY-ALLIS
ST-7625
130 mm



ALLIS
ST-7626

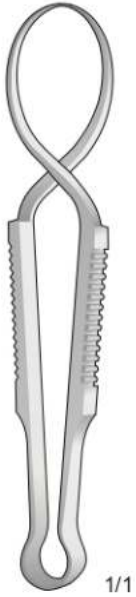
ST-7626-1
150 mm

ST-7626-2
145 mm



ALLIS
ST-7627

ST-7627-1 150 mm	ST-7627-2 150 mm	ST-7627-3 150 mm	ST-7627-4 160 mm	ST-7627-5 200 mm	ST-7627-6 220 mm	ST-7627-7 250 mm
2 x 3 denti 2 x 3 teeth 2 x 3 zähne 2 x 3 dents 2 x 3 dientes	3 x 4 denti 3 x 4 teeth 3 x 4 zähne 3 x 4 dents 3 x 4 dientes	4 x 5 denti 4 x 5 teeth 4 x 5 zähne 4 x 5 dents 4 x 5 dientes	5 x 6 denti 5 x 6 teeth 5 x 6 zähne 5 x 6 dents 5 x 6 dientes	5 x 6 denti 5 x 6 teeth 5 x 6 zähne 5 x 6 dents 5 x 6 dientes	5 x 6 denti 5 x 6 teeth 5 x 6 zähne 5 x 6 dents 5 x 6 dientes	5 x 6 denti 5 x 6 teeth 5 x 6 zähne 5 x 6 dents 5 x 6 dientes



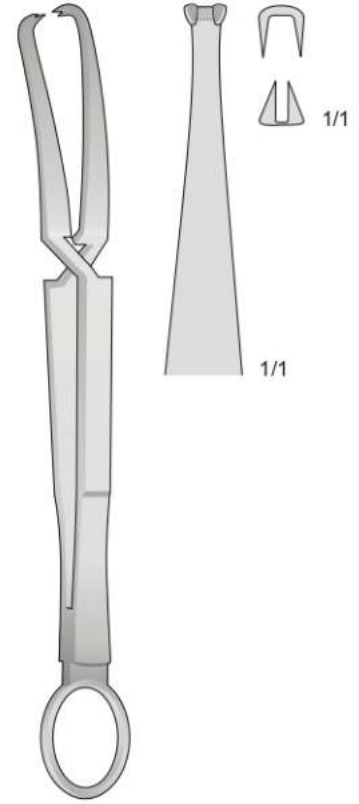
SCHAEDDEL
ST-7628
85 mm



JONES
ST-7629
90 mm



FAURE
ST-7630
85 mm



DOYEN
ST-7631
180 mm

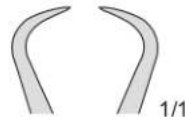


1/1



1/1

ST-7632-1
90 mm



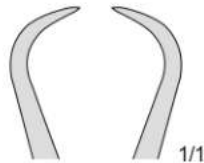
1/1

ST-7632-2
100 mm



1/1

ST-7632-3
110 mm



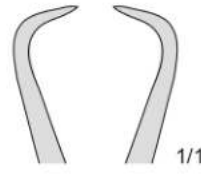
1/1

ST-7632-4
130 mm



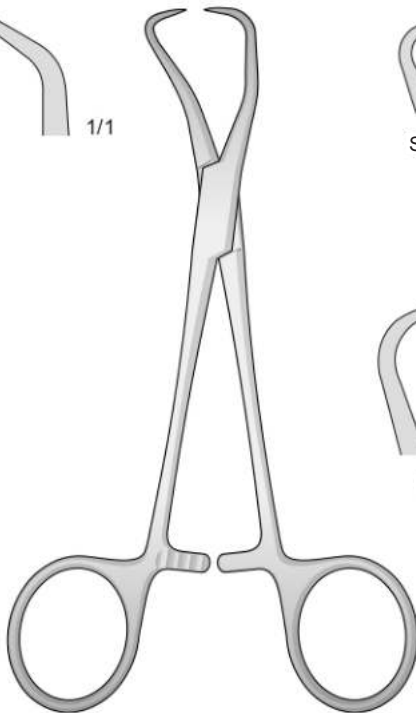
1/1

ST-7632-5
135 mm

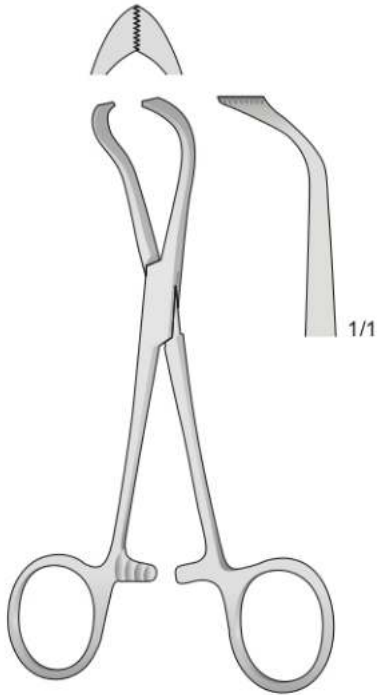


1/1

ST-7632-6
140 mm

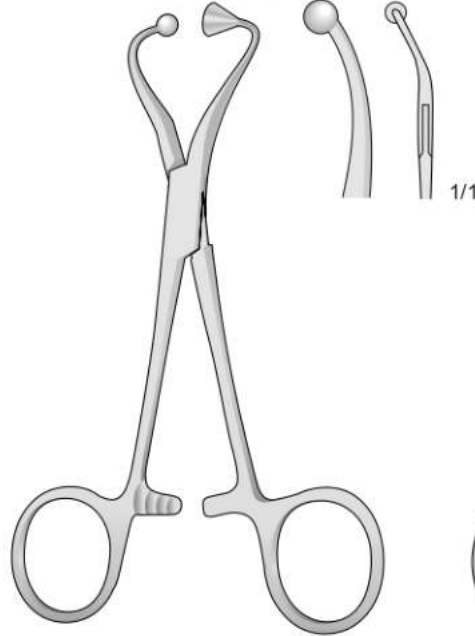


BACKHAUS
ST-7632



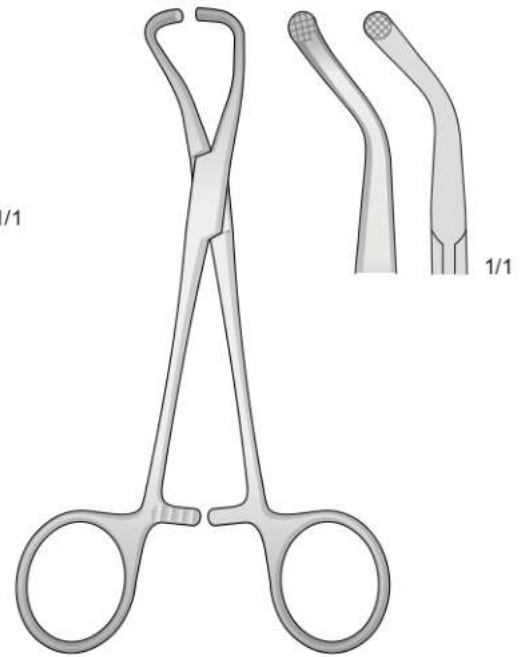
LORNA
ST-7633
100 mm

Per teli di carta
For paper cloths
Für Papiertücher
Pour Champs en papier



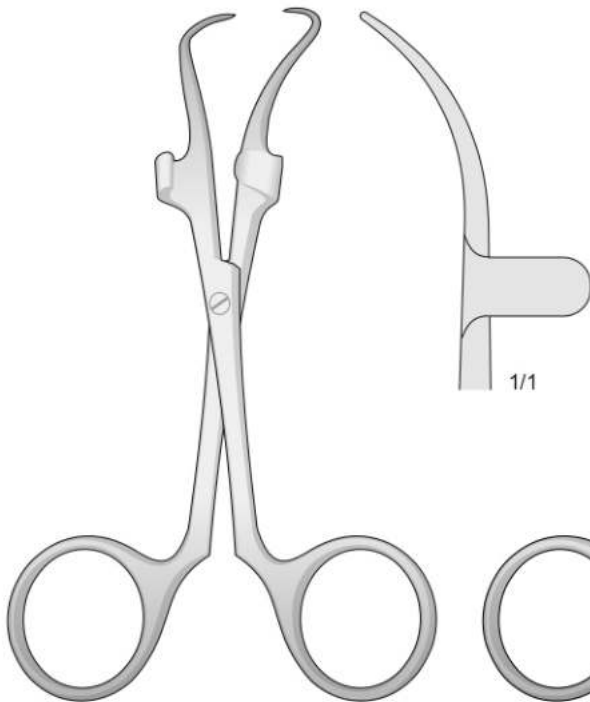
ST-7634
115 mm

Per teli di carta
For paper cloths
Für Papiertücher
Pour Champs en papier

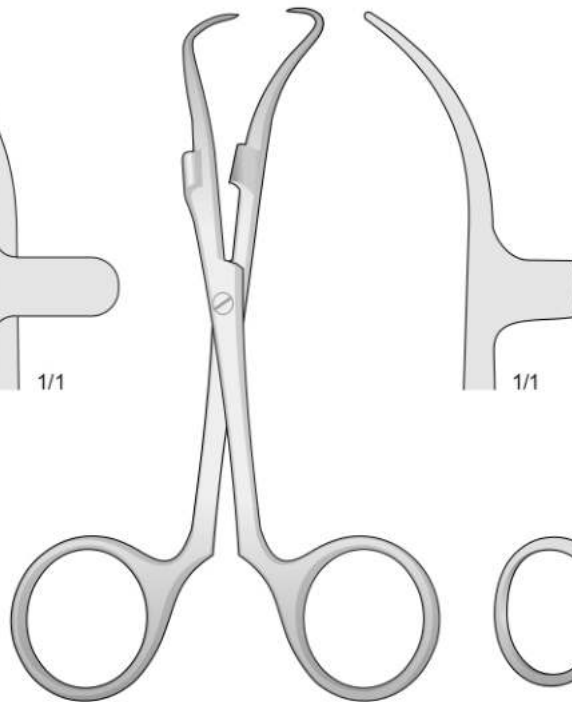


ST-7635
130 mm

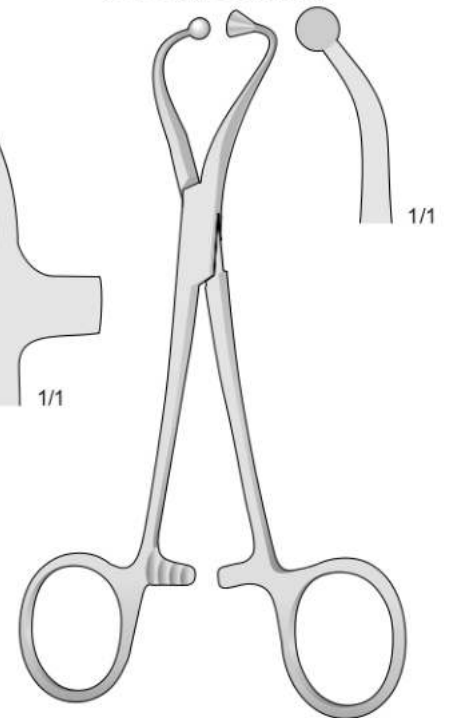
Per teli di carta
For paper cloths
Für Papiertücher
Pour Champs en papier



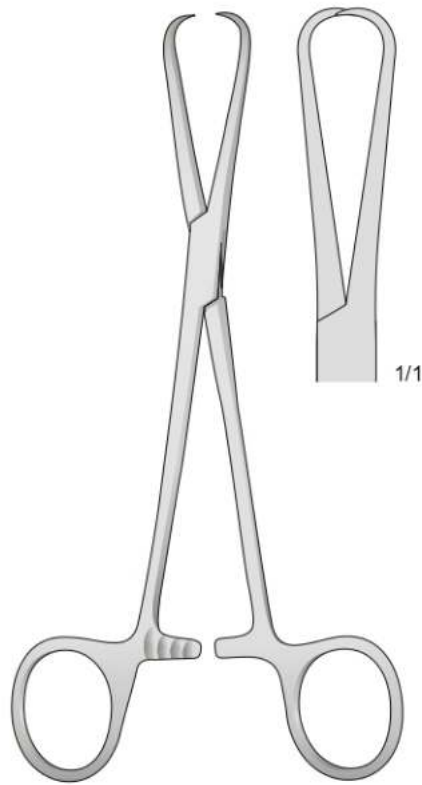
ROBIN
ST-7636
140 mm



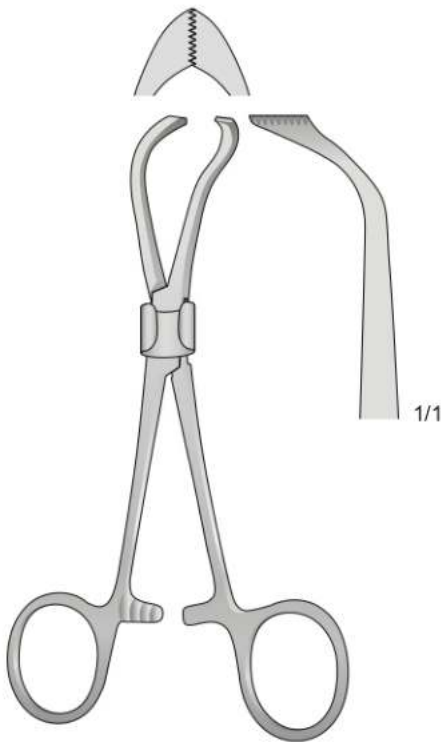
ROBIN
ST-7637
140 mm



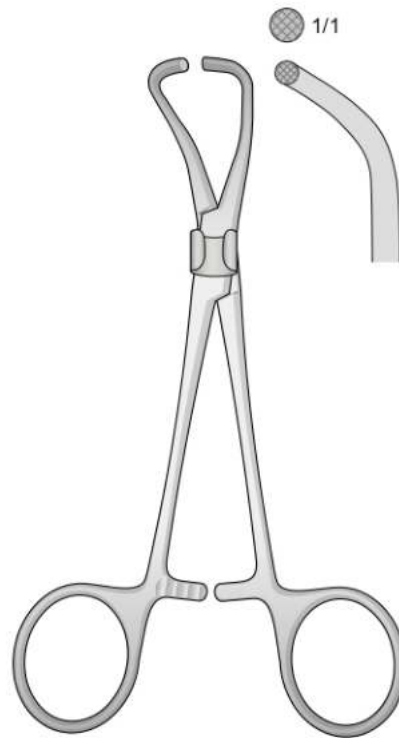
ST-7638
140 mm



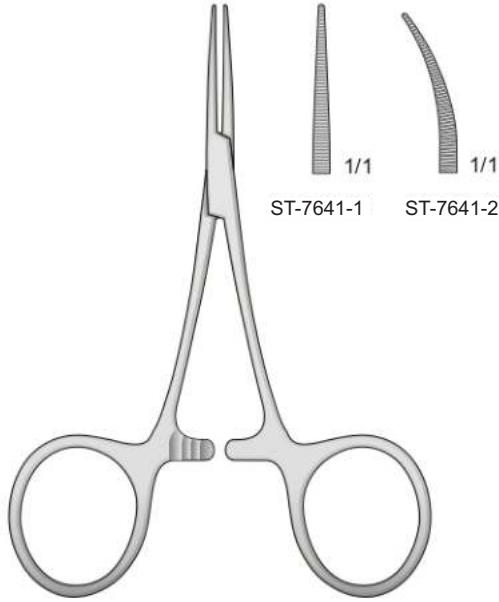
BERNHARD
ST-7639
165 mm



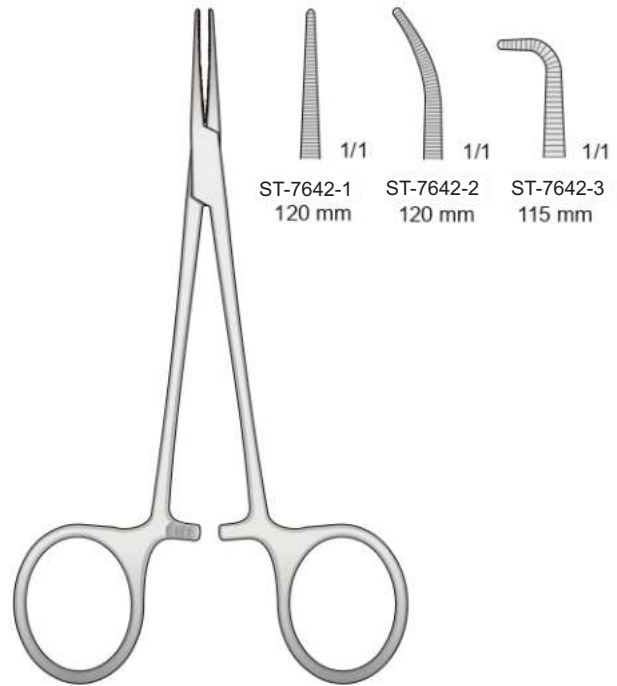
ST-7639-1 Ø 9 mm ST-7639-3 Ø 12 mm
ST-7639-2 Ø 14 mm ST-7639-4 Ø 17 mm
100 mm



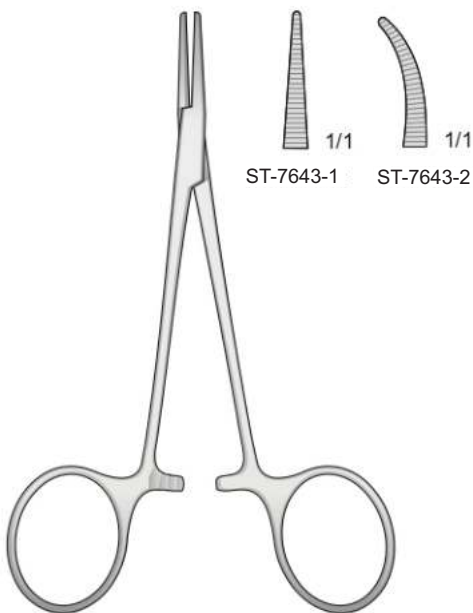
ST-7640-1 Ø 9 mm ST-7640-3 Ø 12 mm
ST-7640-2 Ø 14 mm ST-7640-4 Ø 17 mm
130 mm
ST-7640



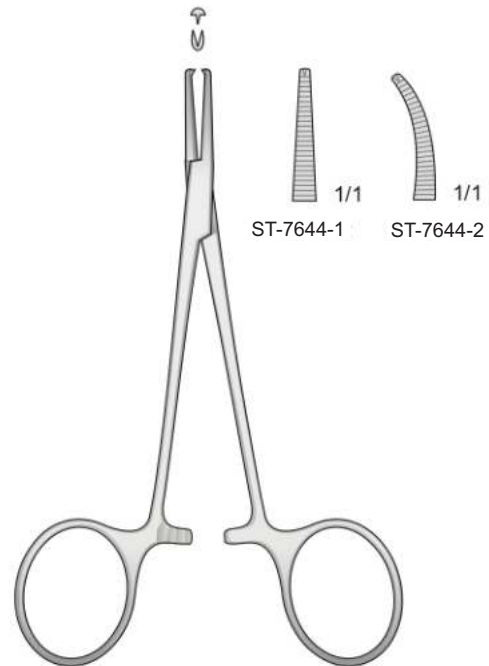
HARTMANN-BABY-MOSQUITO
ST-7641
95 mm



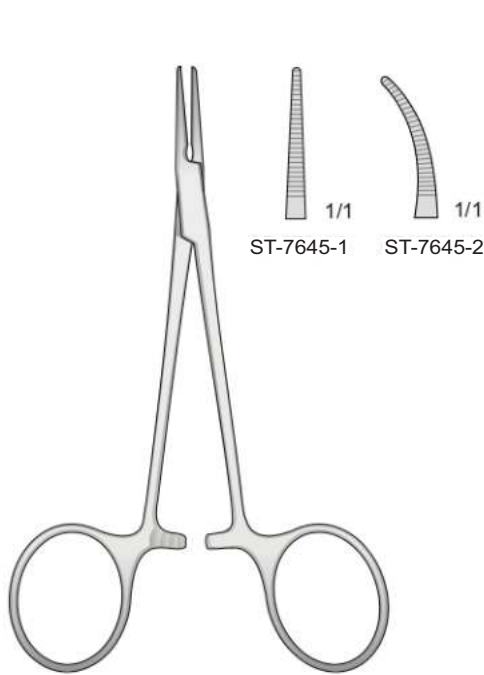
MICRO-HALSTED
ST-7642



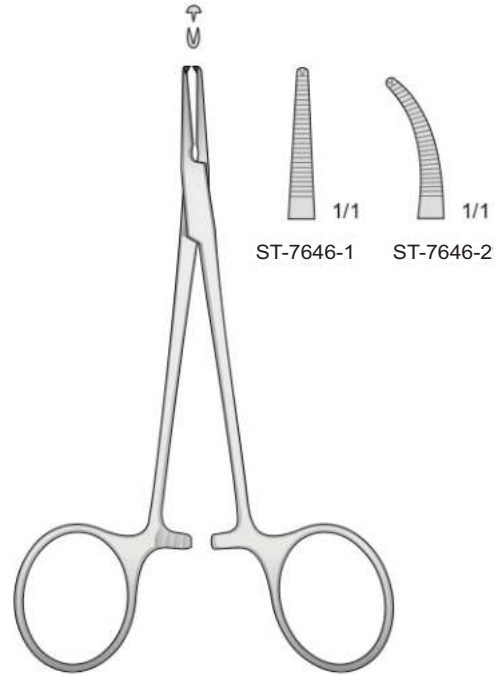
HALSTED-MOSQUITO
ST-7643
120 mm



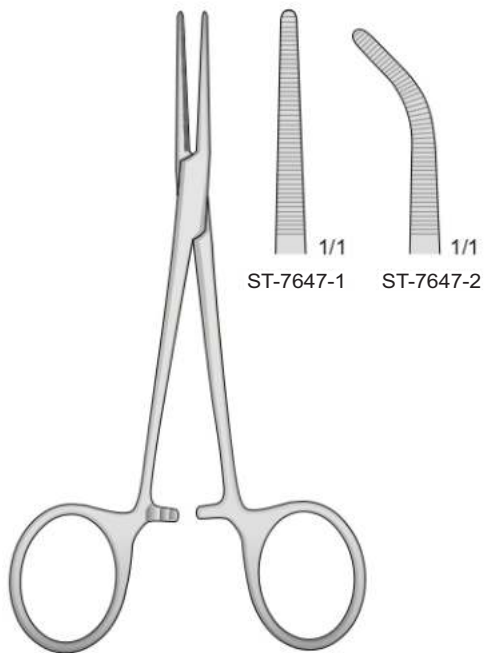
HALSTED-MOSQUITO
ST-7644
120 mm



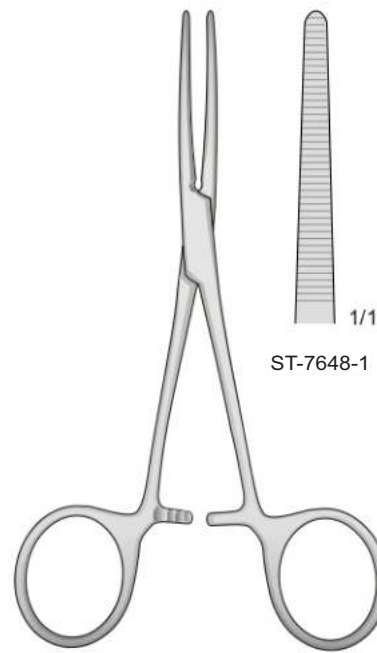
HALSTED
ST-7645
125 mm



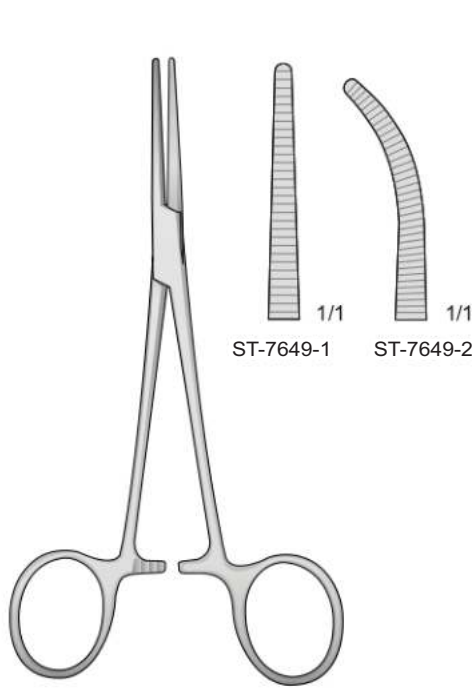
HALSTED
ST-7646
125 mm



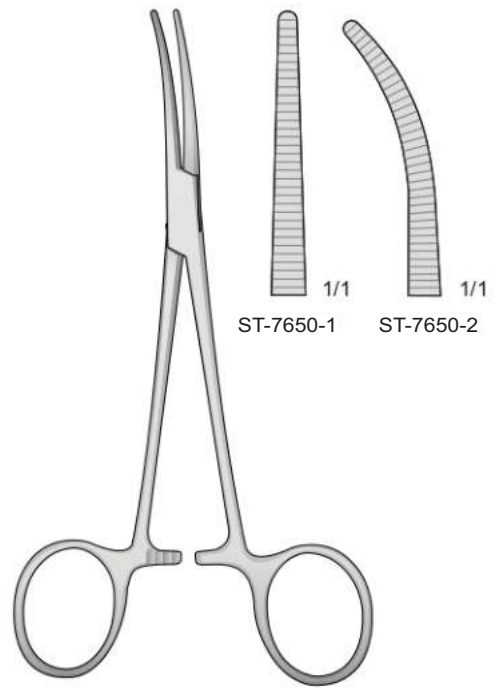
GIDEF
05-710
140 mm



PEAN
ST-7648
140 mm

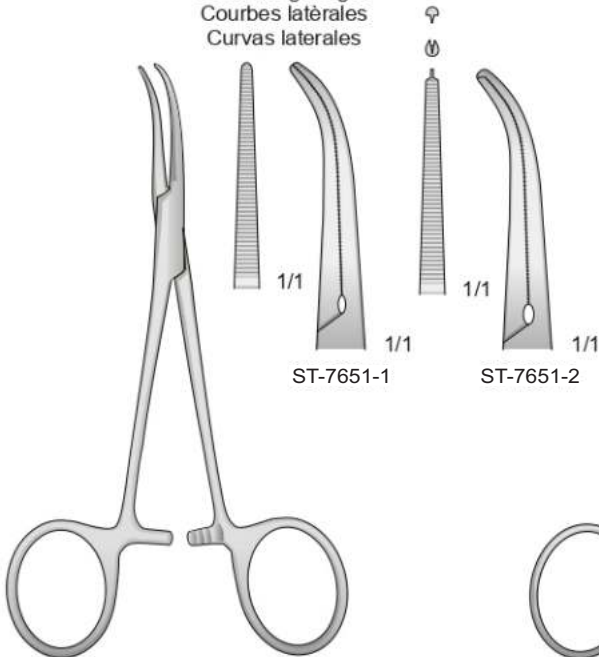


CRILE
ST-7649
140 mm

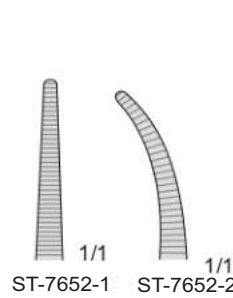


CRILE
ST-7650
160 mm

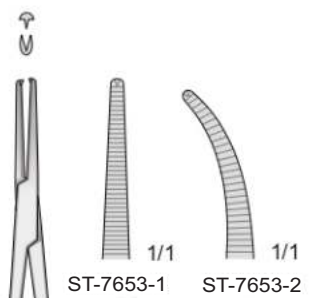
Curve sul lato
Curved to side
Seitwärts gebogen
Courbes latérales
Curvas laterales



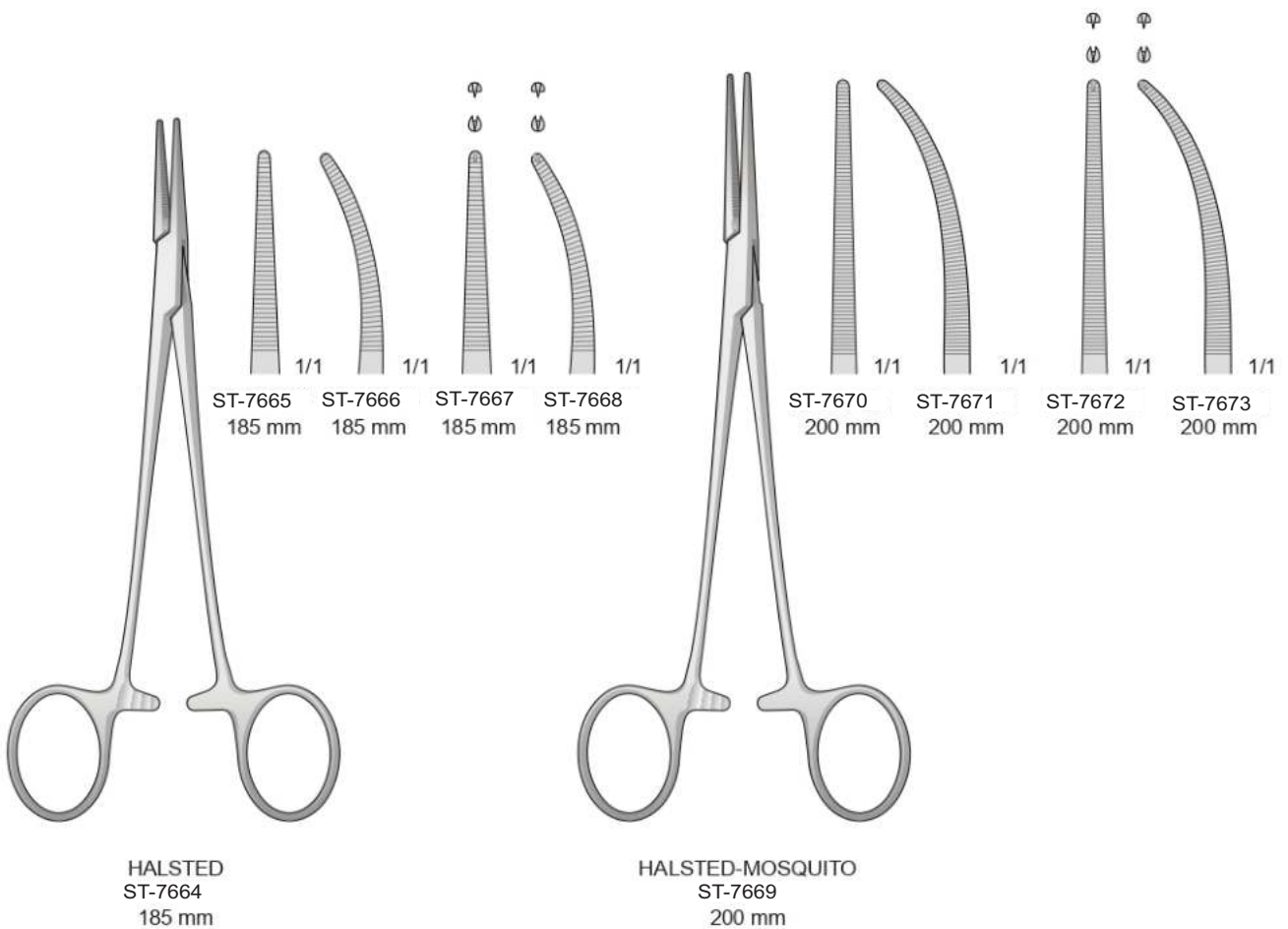
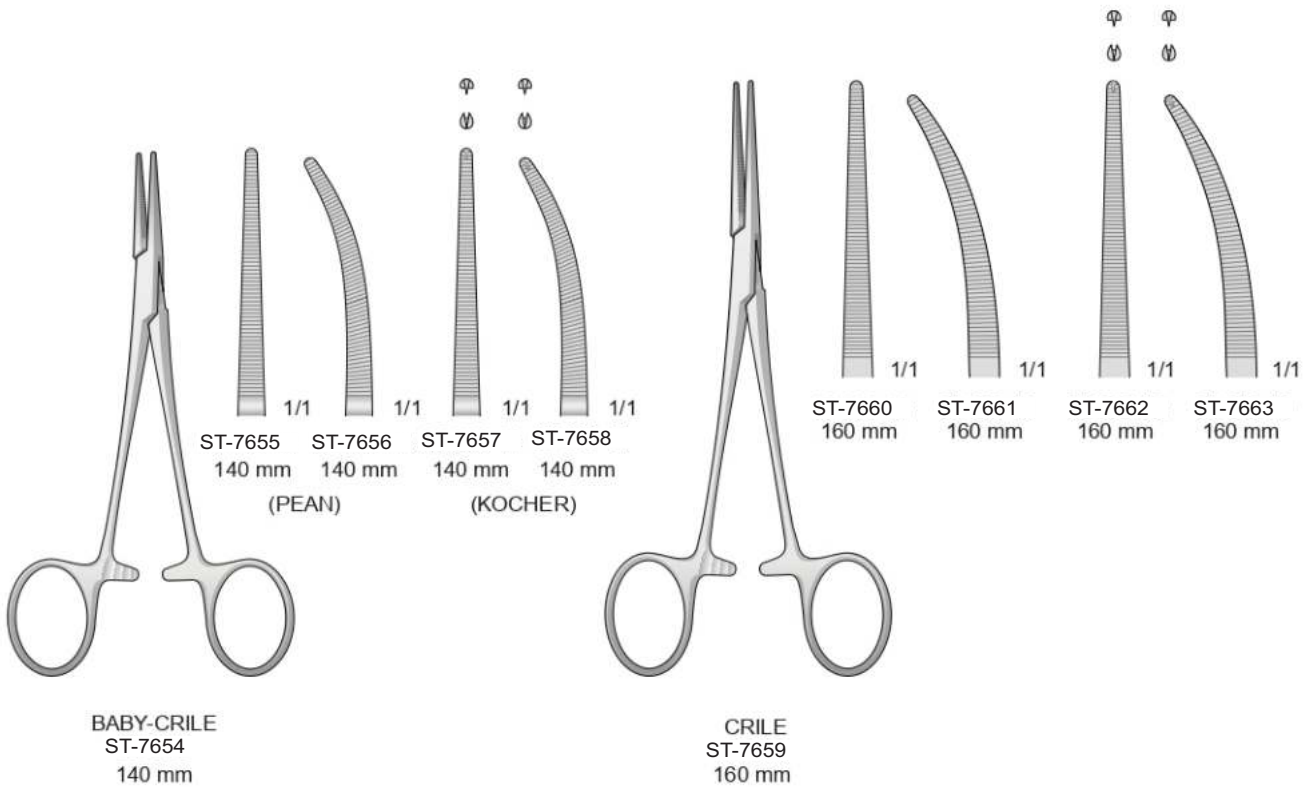
DANDY
ST-7651
140 mm

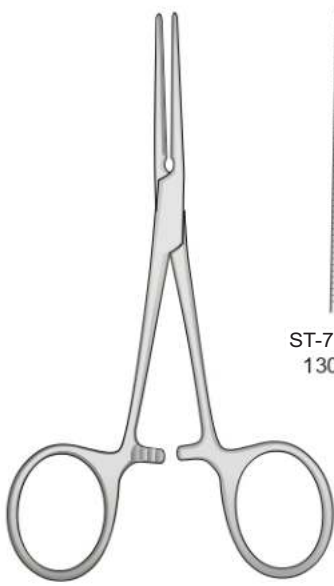


LERICHE
ST-7652
150 mm

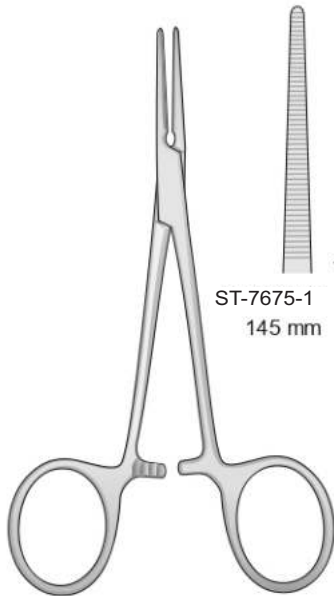
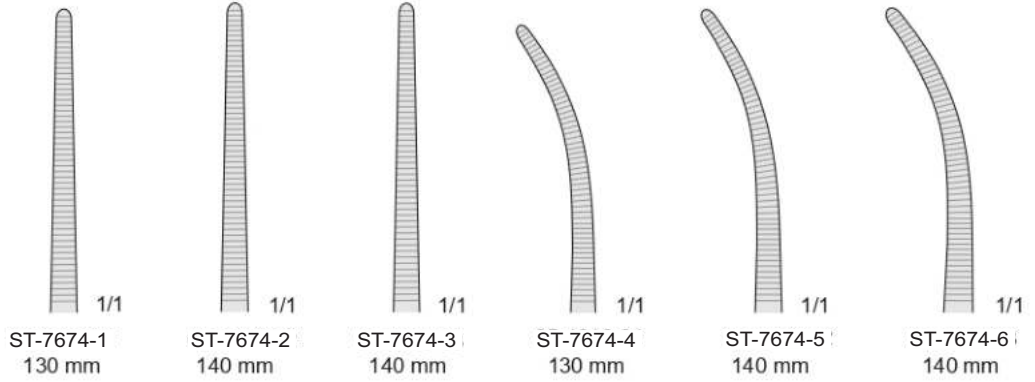


LERICHE
ST-7653
150 mm

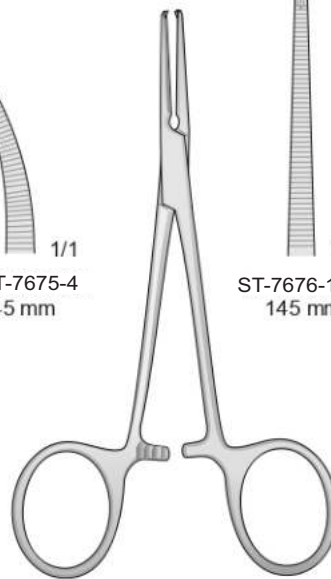
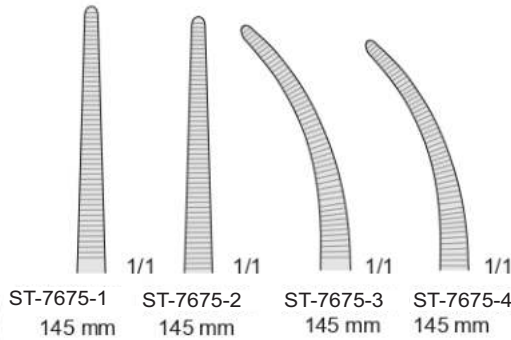




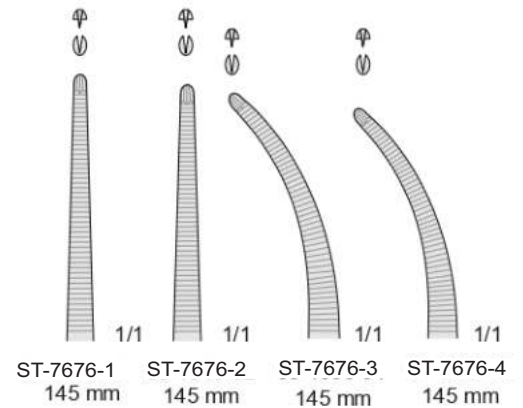
PEAN
ST-7674

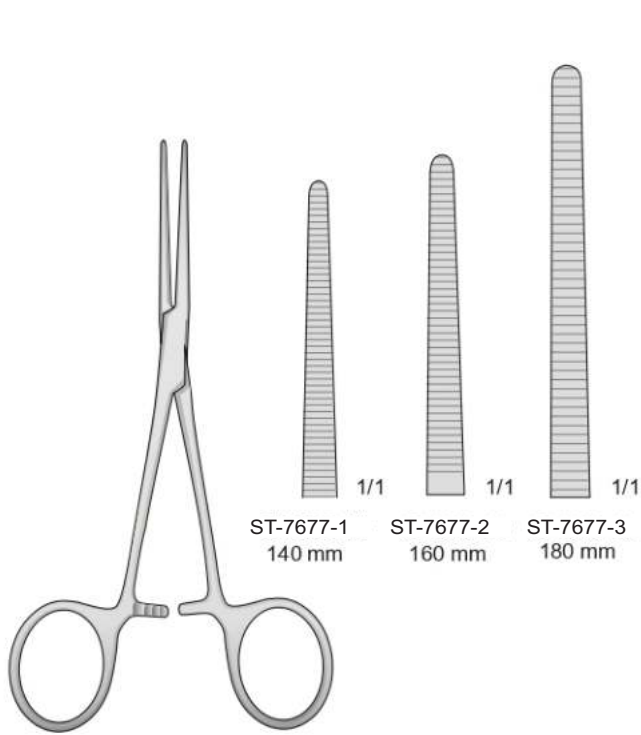


PEAN
ST-7675

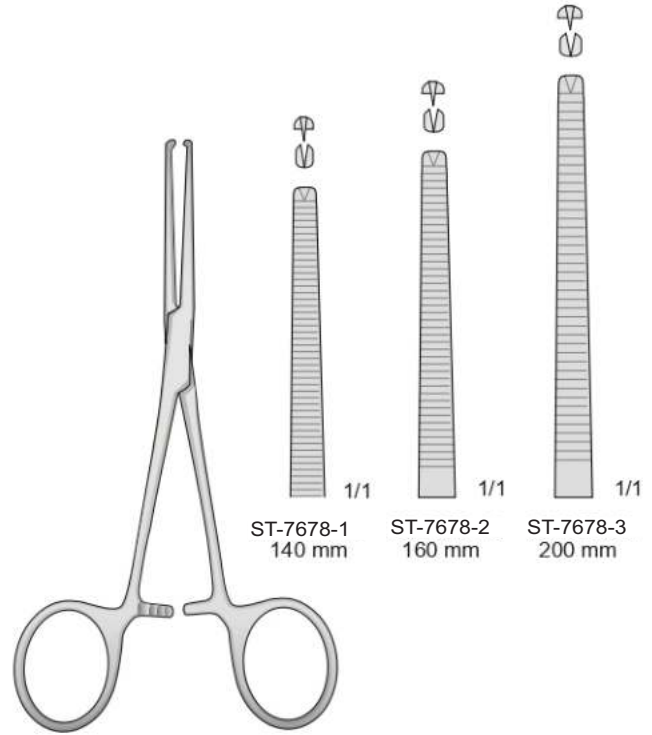


KOCHER
ST-7676

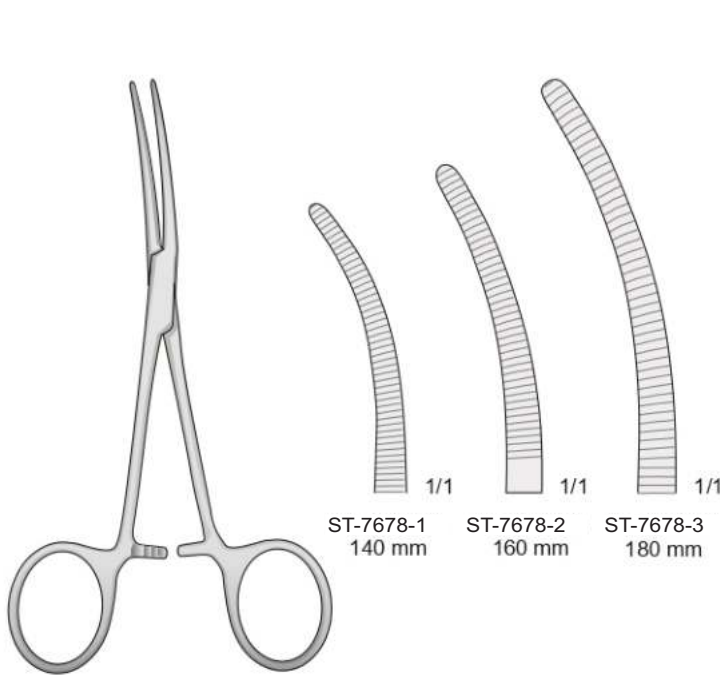




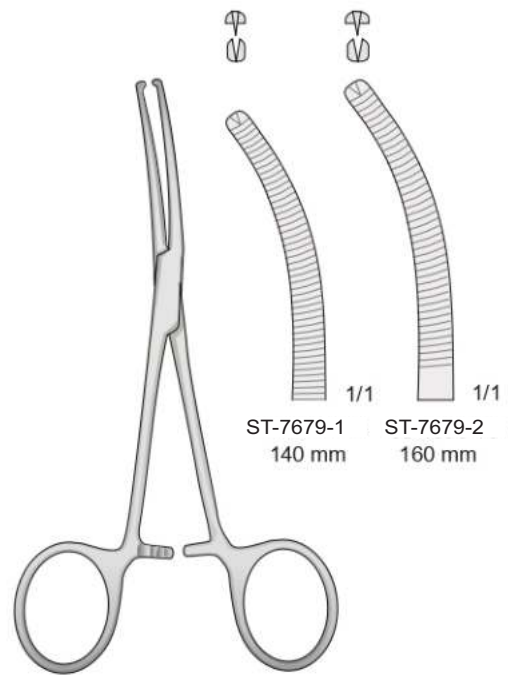
ROCHESTER-PEAN
ST-7677



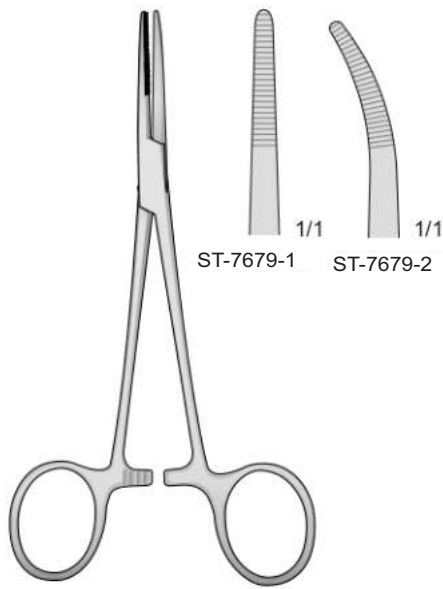
KOCHER-OCHSNER
ST-7678



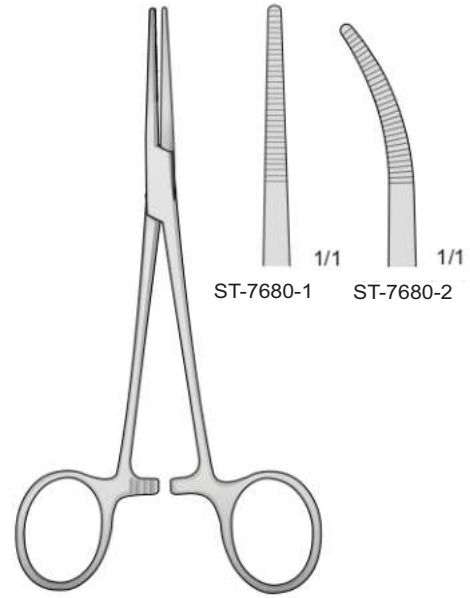
ROCHESTER-PEAN
ST-7678



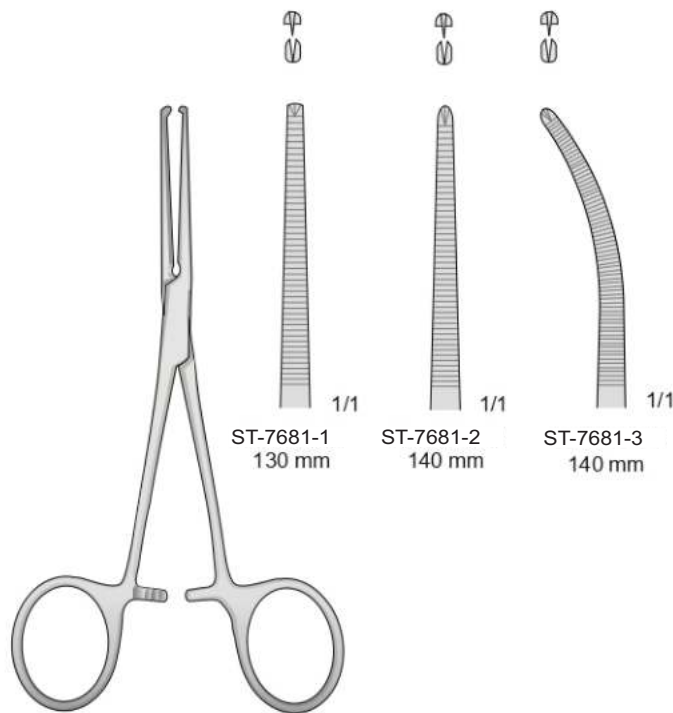
KOCHER-OCHSNER
ST-7679



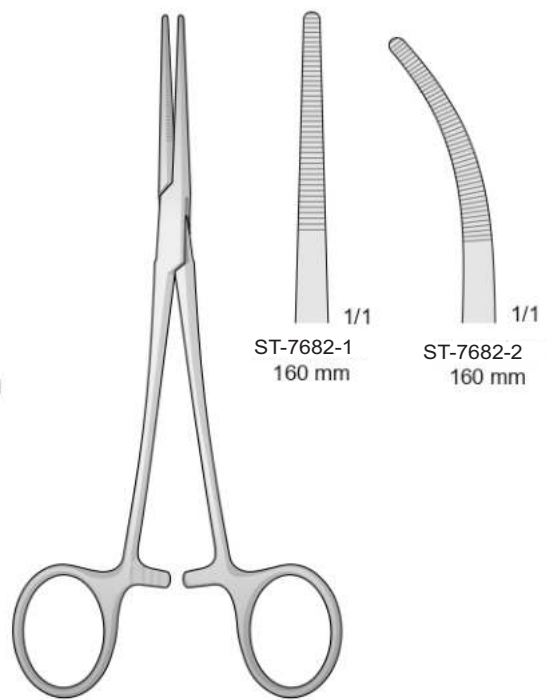
KELLY
ST-7679
140 mm



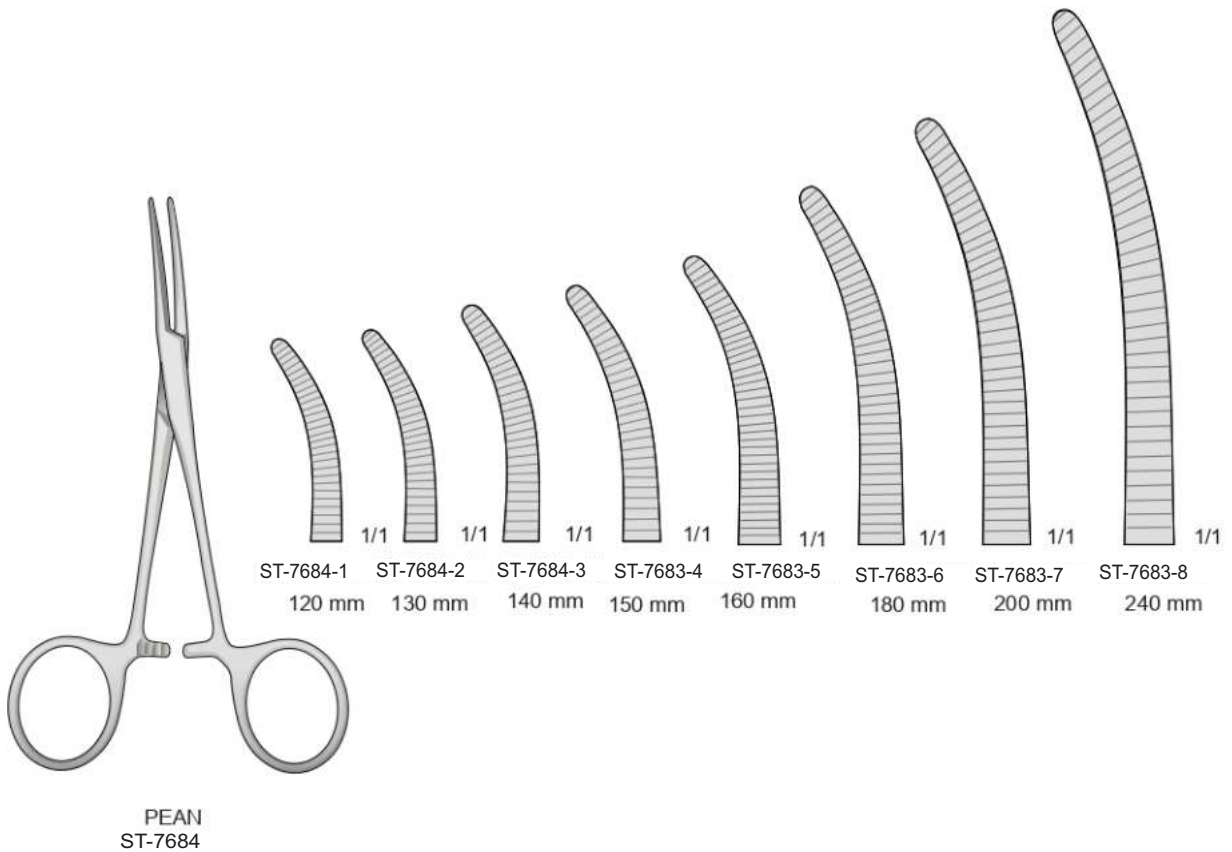
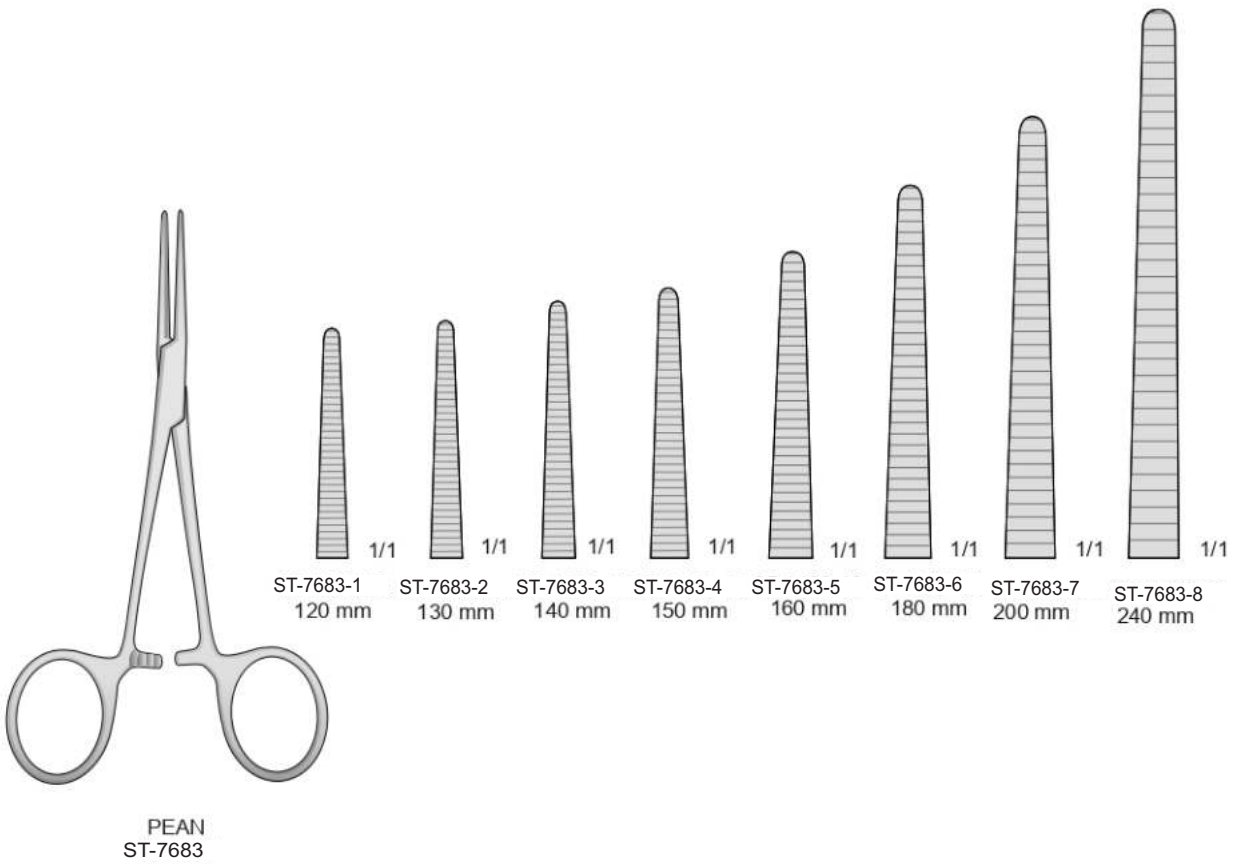
KELLY
ST-7680
140 mm

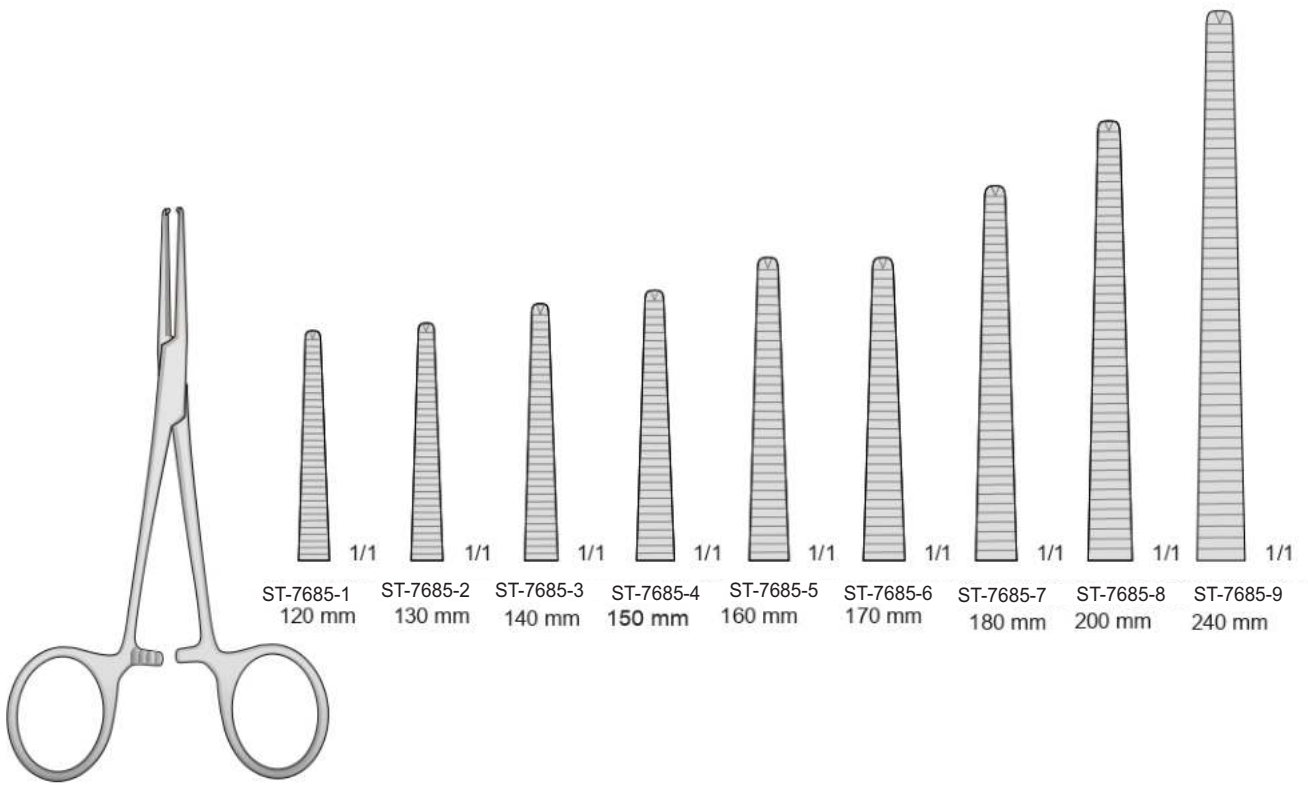


KOCHER
ST-7681

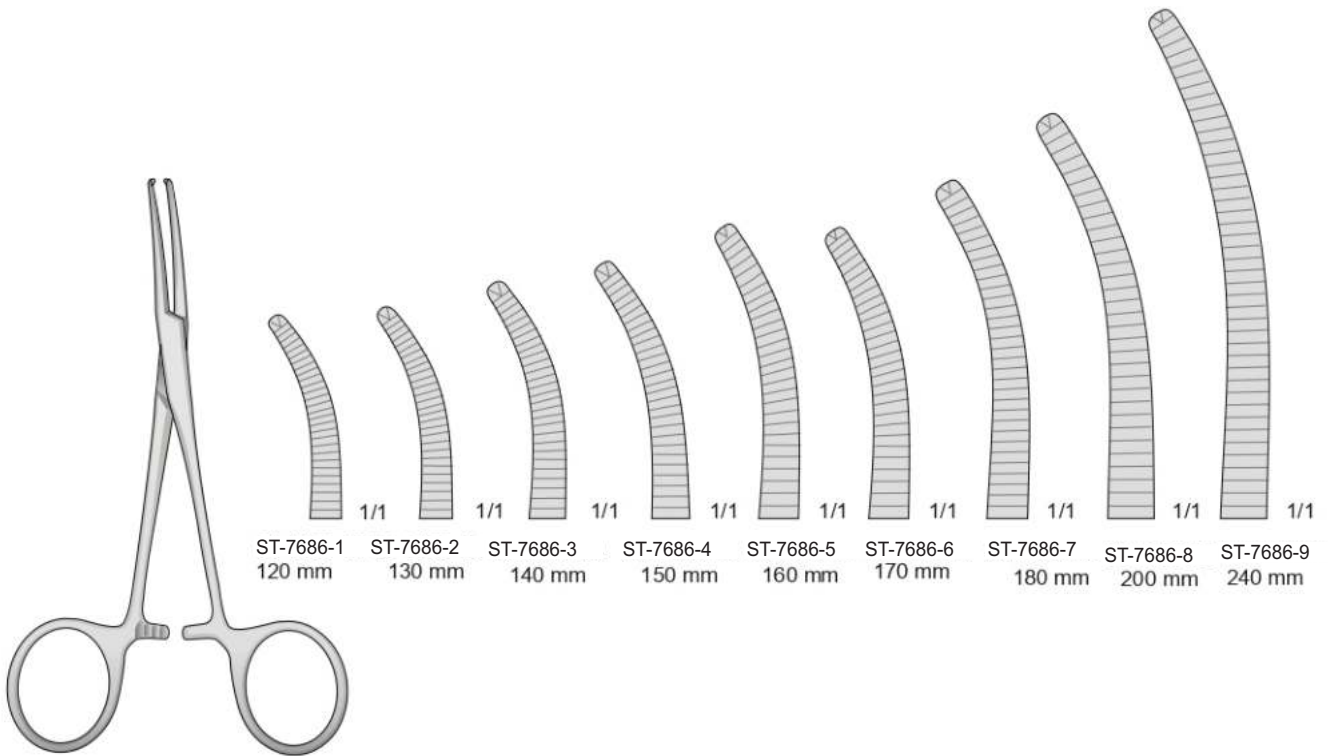


RANKIN
ST-7682

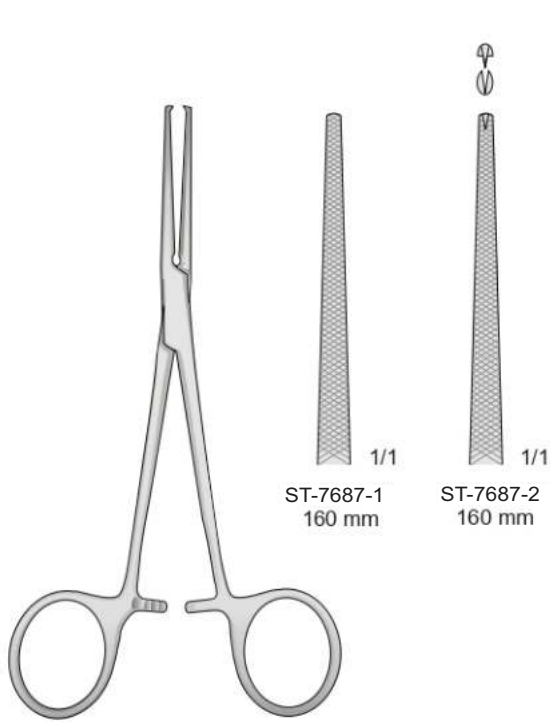




KOCHER
ST-7685



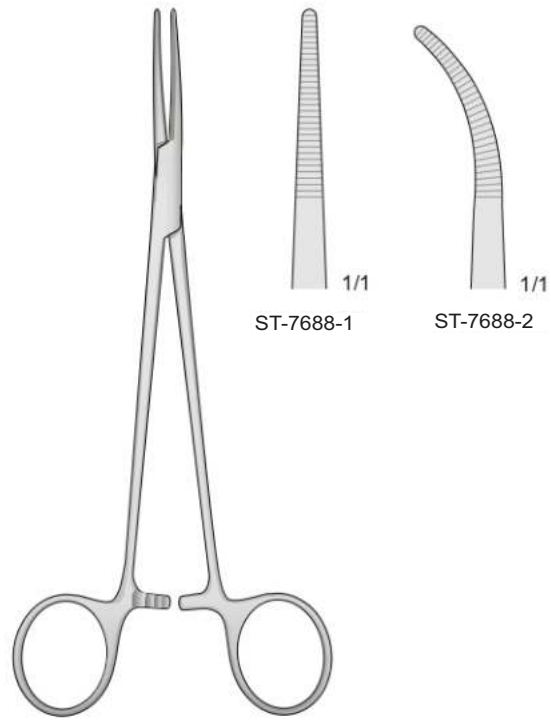
KOCHER
ST-7686



DIXON-LOVELACE
ST-7687

ST-7687-1
160 mm

ST-7687-2
160 mm

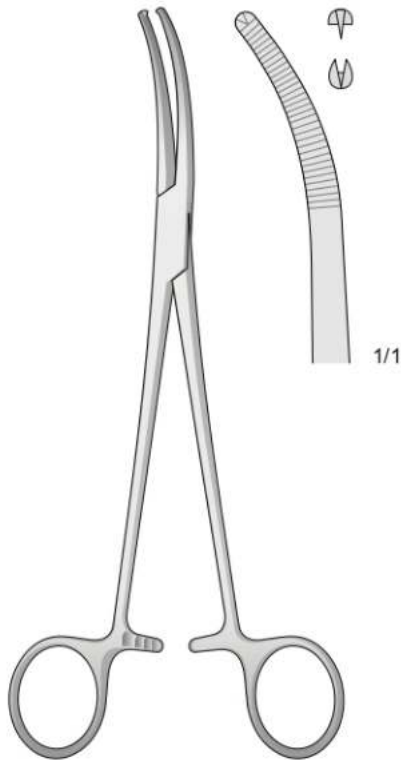


BIRKETT
ST-7688
180 mm

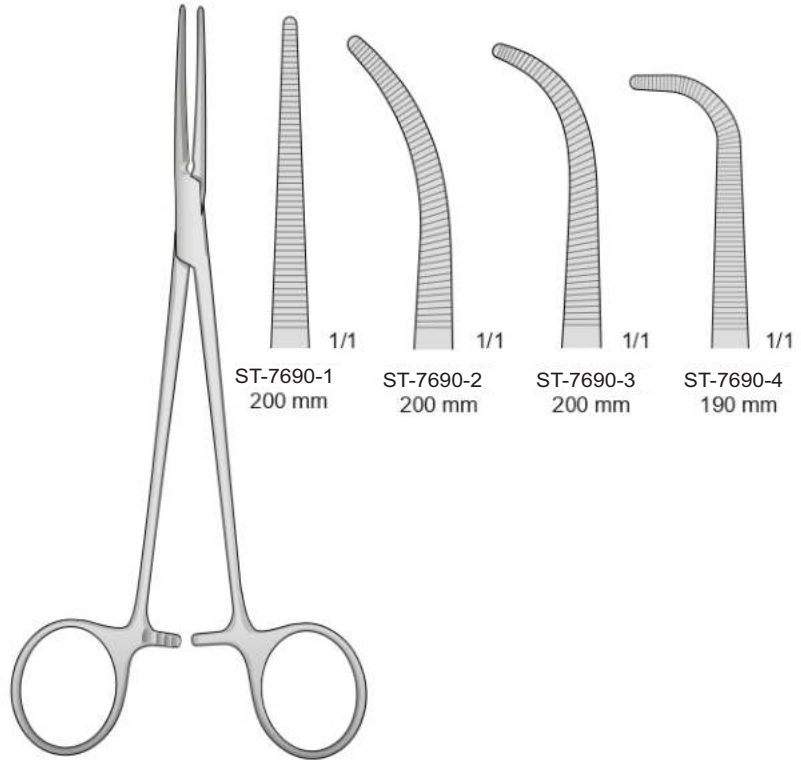
ST-7688-1

ST-7688-2

Pinza per peritoneo - Peritoneal clamps forceps
Pritoneum klemmen - Pincas-camps pour les péritoine
Pinzas-clamps para peritoneo



MIKULICZ
ST-7689
190 mm



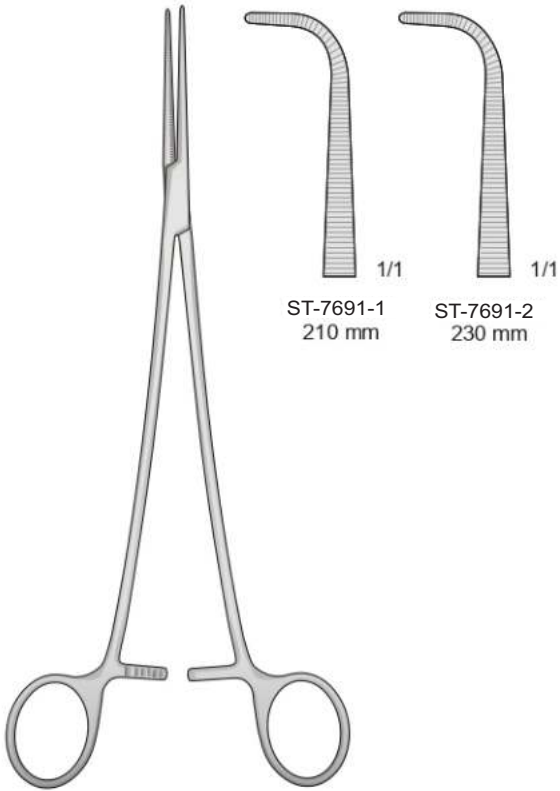
HEISS
ST-7690

ST-7690-1
200 mm

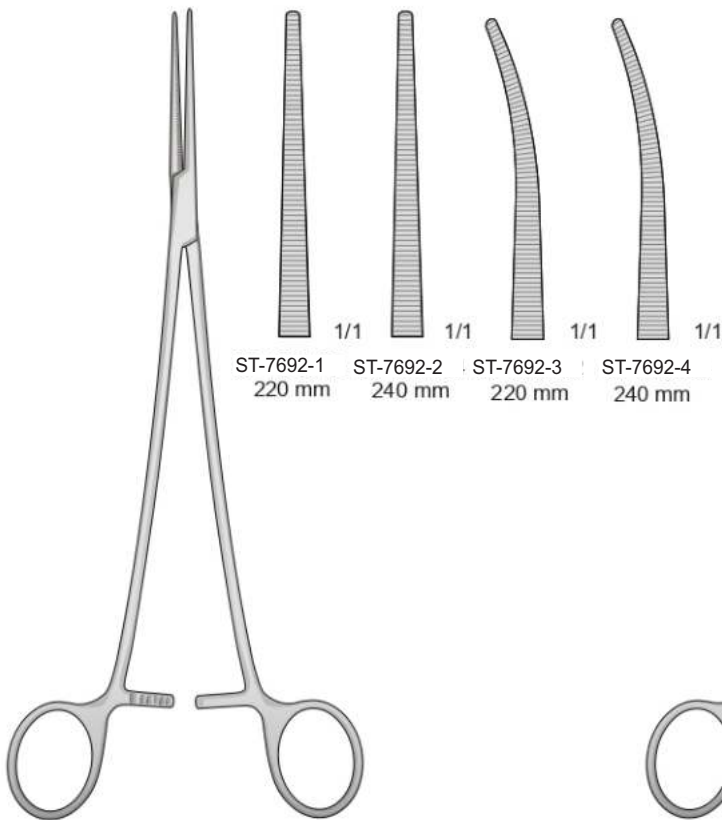
ST-7690-2
200 mm

ST-7690-3
200 mm

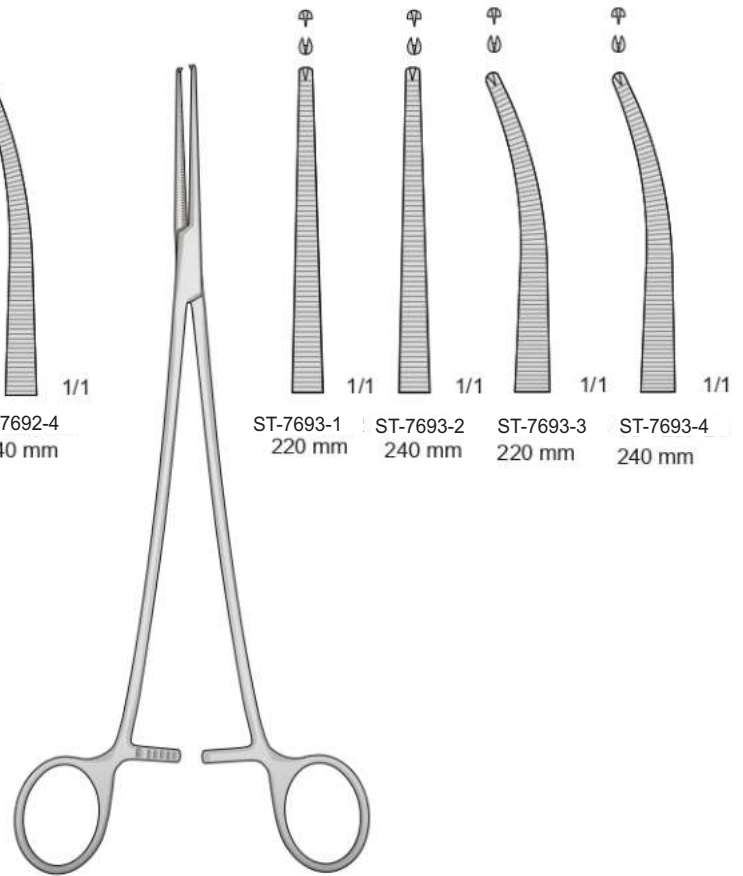
ST-7690-4
190 mm



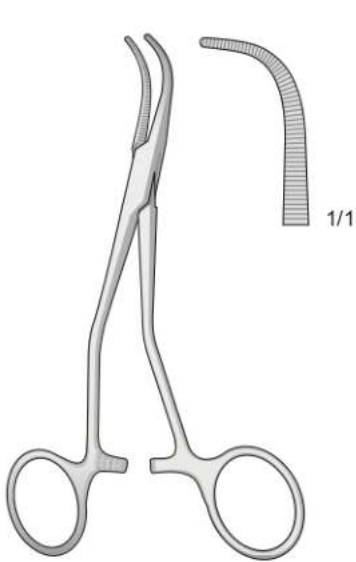
BENGOLEA
ST-7691



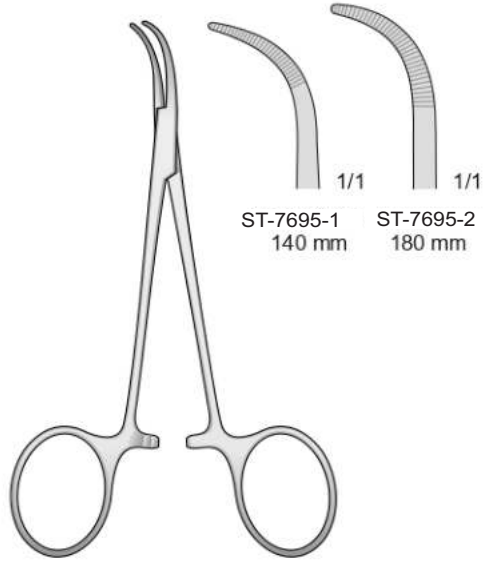
BENGOLEA
ST-7692



BENGOLEA
ST-7693



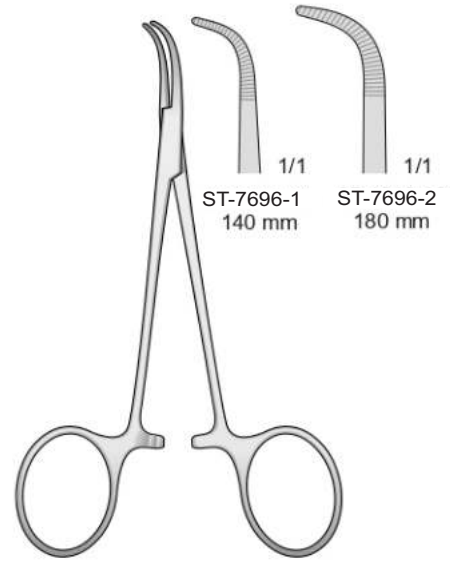
ST-7694
130 mm



BABY-MIXTER
ST-7695

ST-7695-1
140 mm

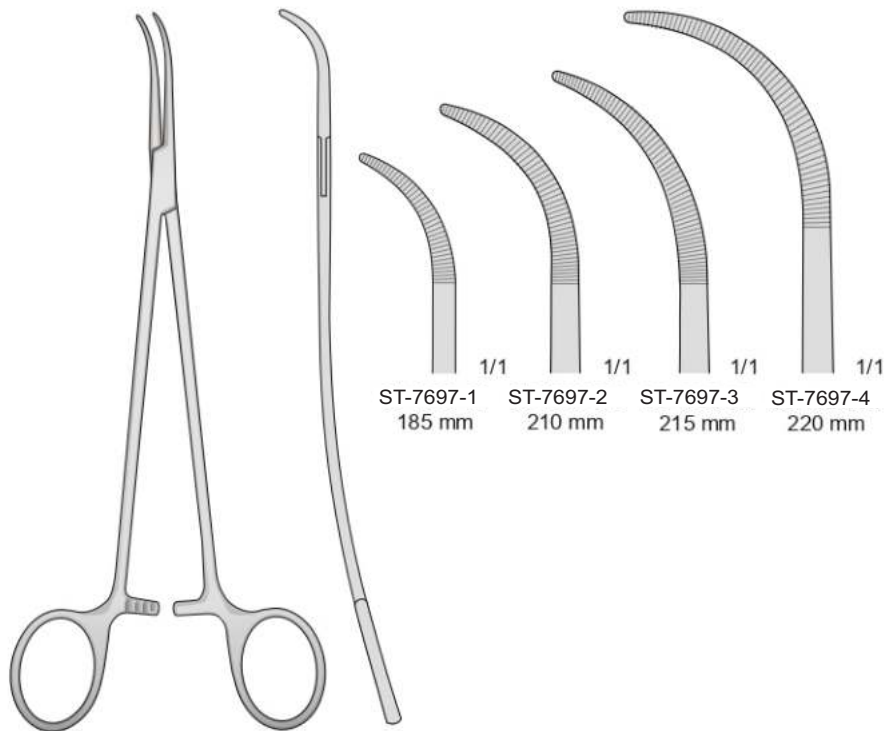
ST-7695-2
180 mm



BABY-ADSON
ST-7696

ST-7696-1
140 mm

ST-7696-2
180 mm



ST-7697

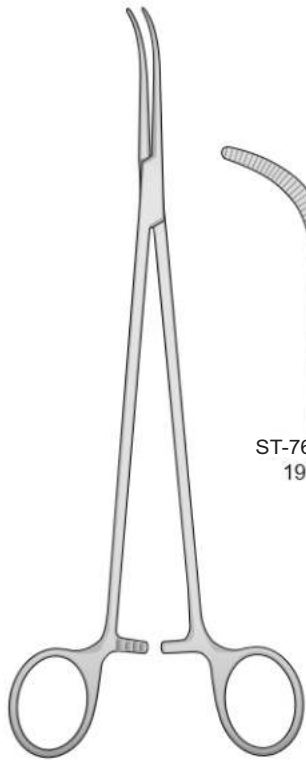
ST-7697-1
185 mm

ST-7697-2
210 mm

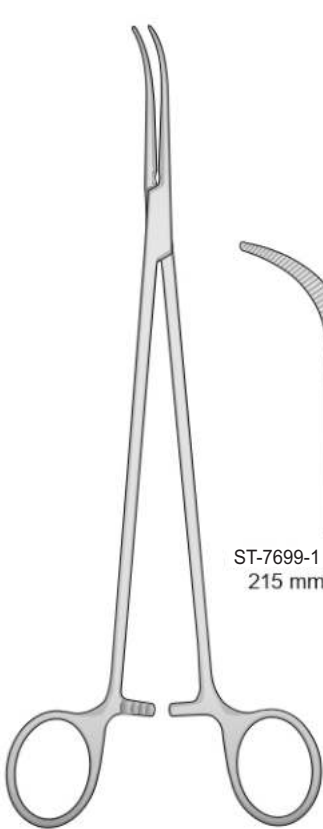
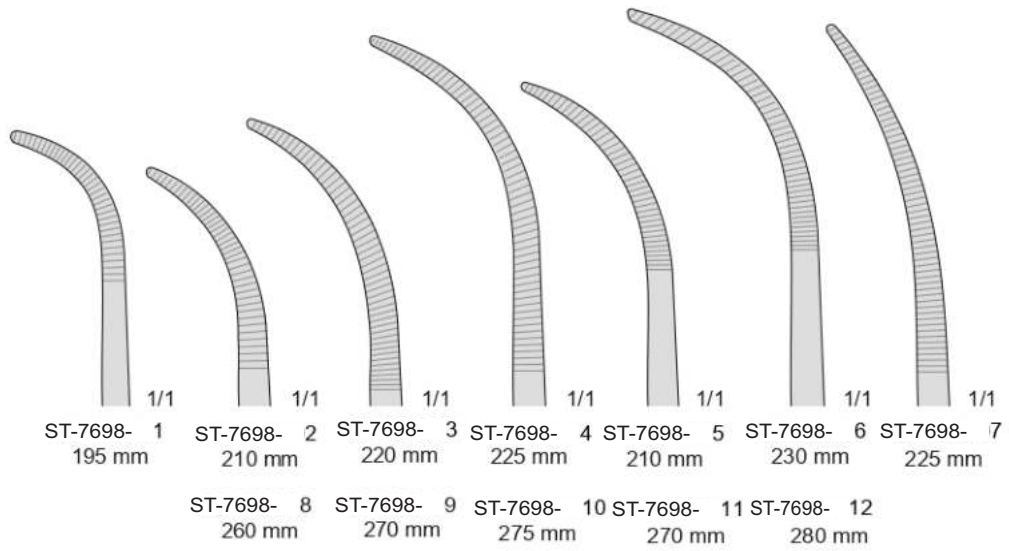
ST-7697-3
215 mm

ST-7697-4
220 mm

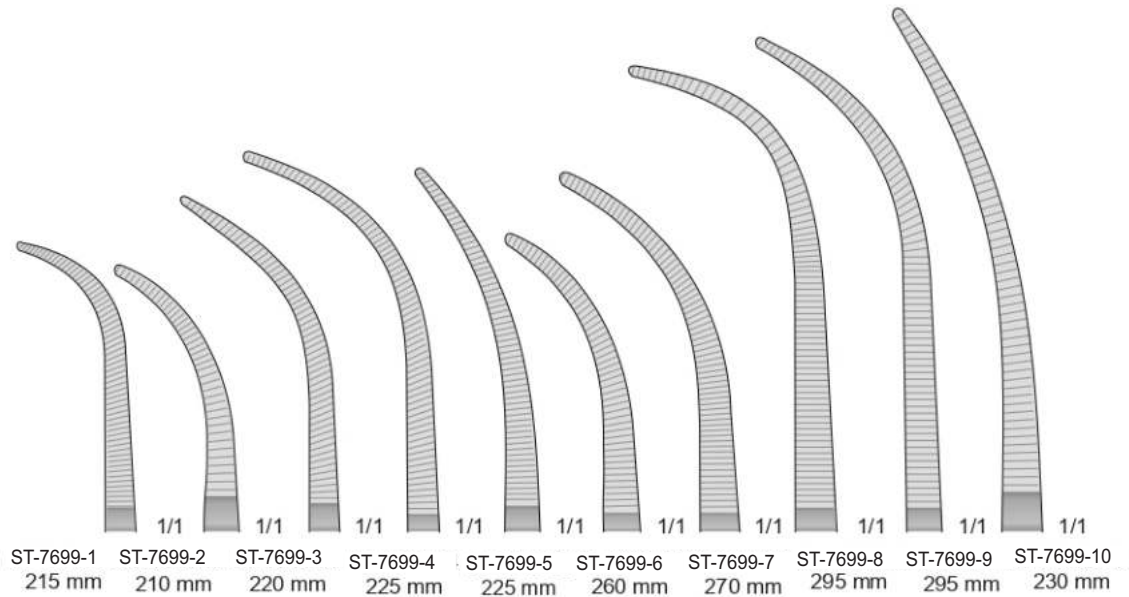
Passafili

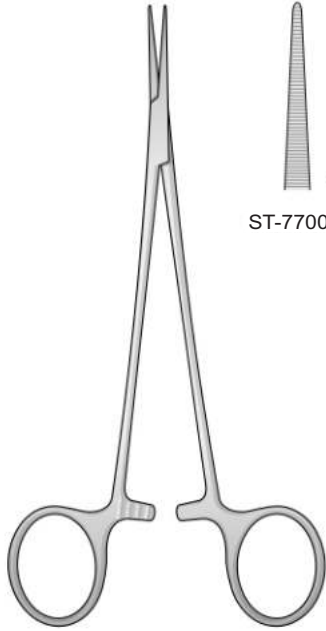


OVERHOLT-GEISSENDORFER
ST-7698

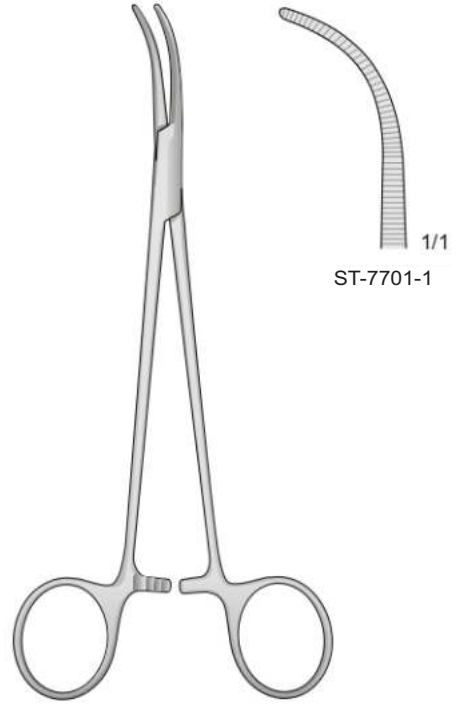
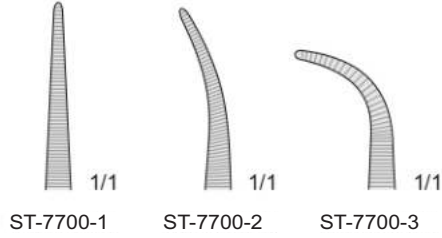


OVERHOLT
ST-7699



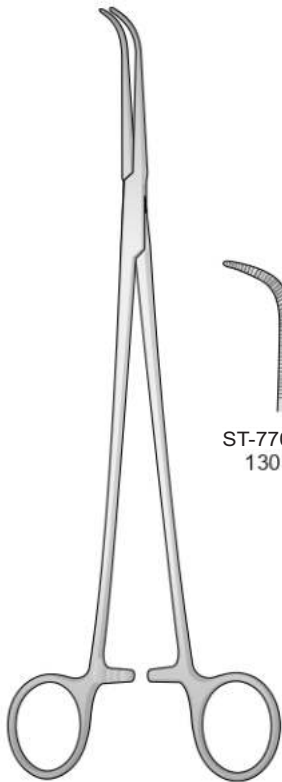


ST-7700
160 mm

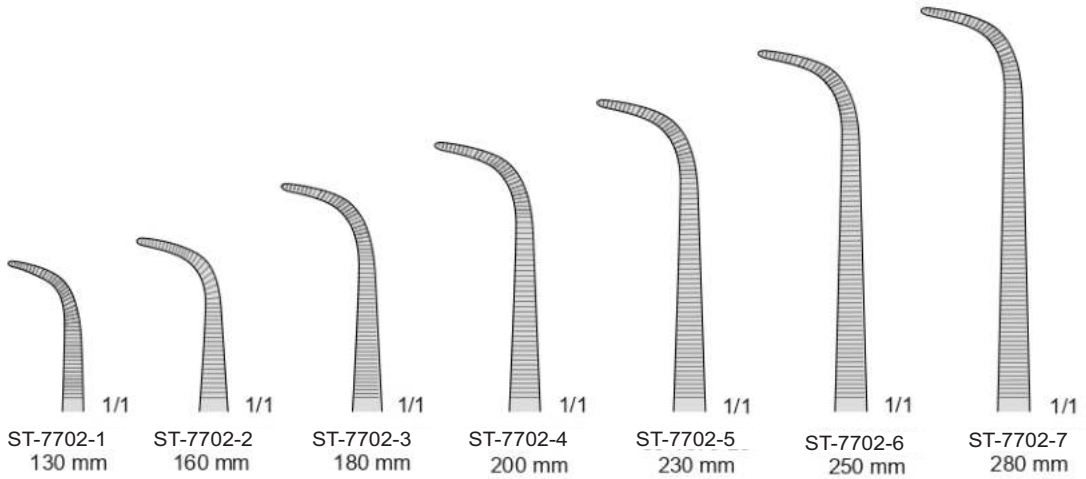


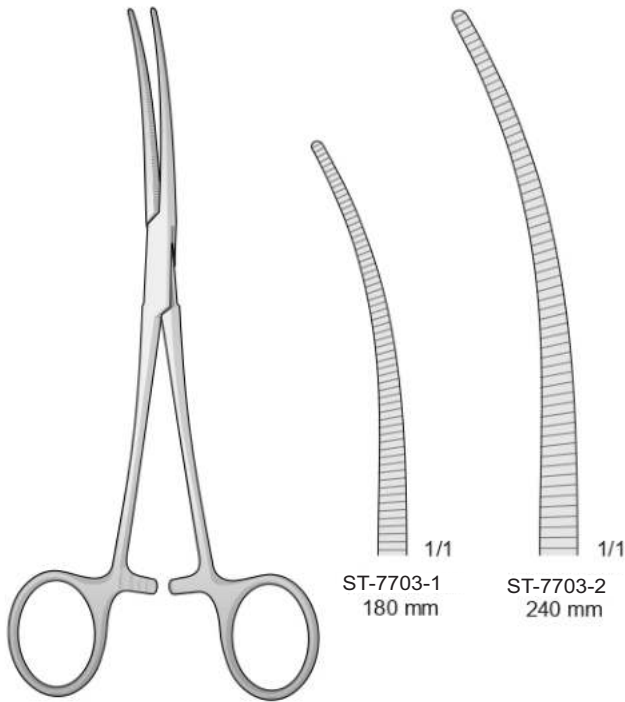
ROCHESTER-PEAN
ST-7701
180 mm

ST-7701-1
1/1

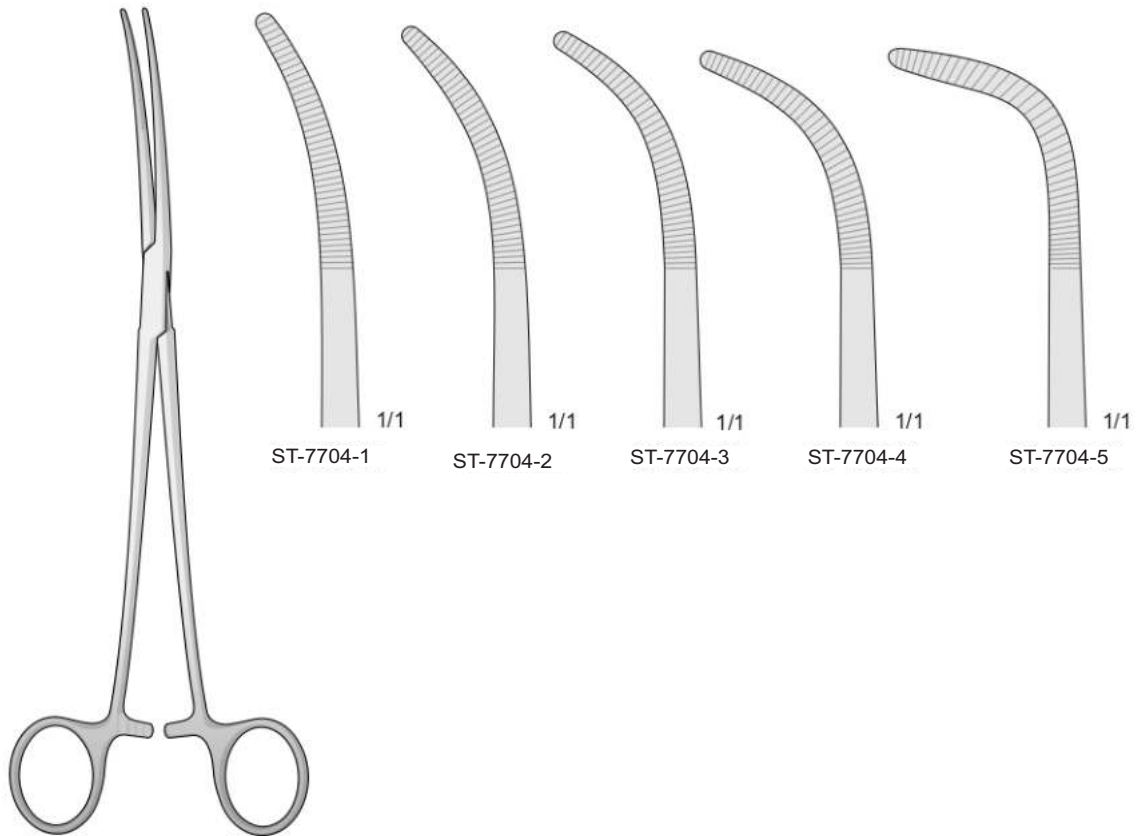


GEMINI
ST-7702

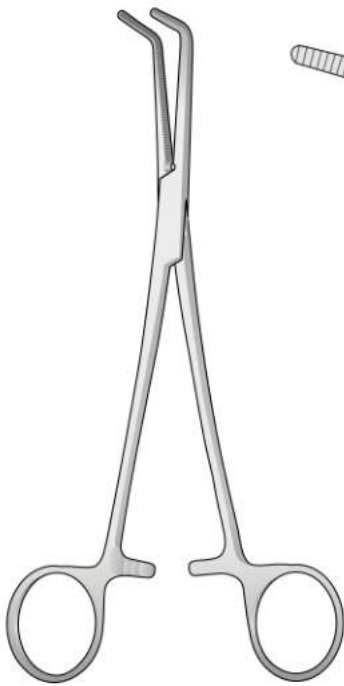




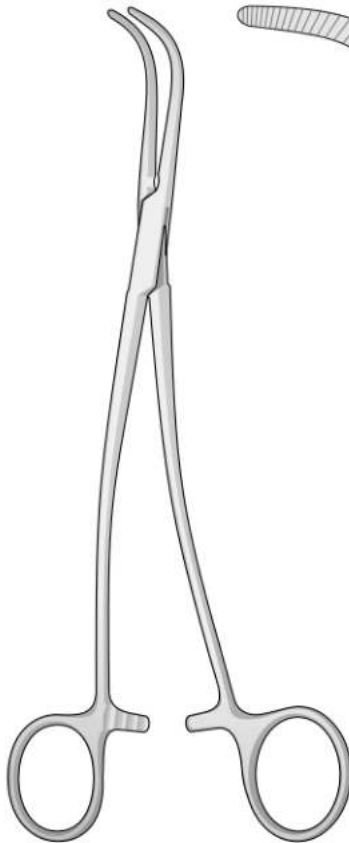
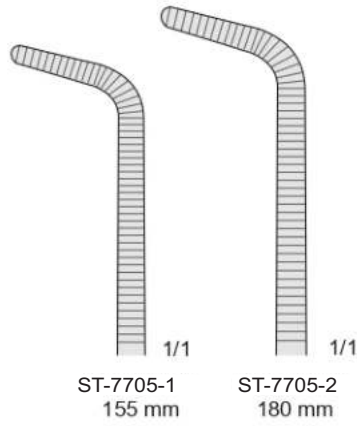
CRAFOORD
ST-7703



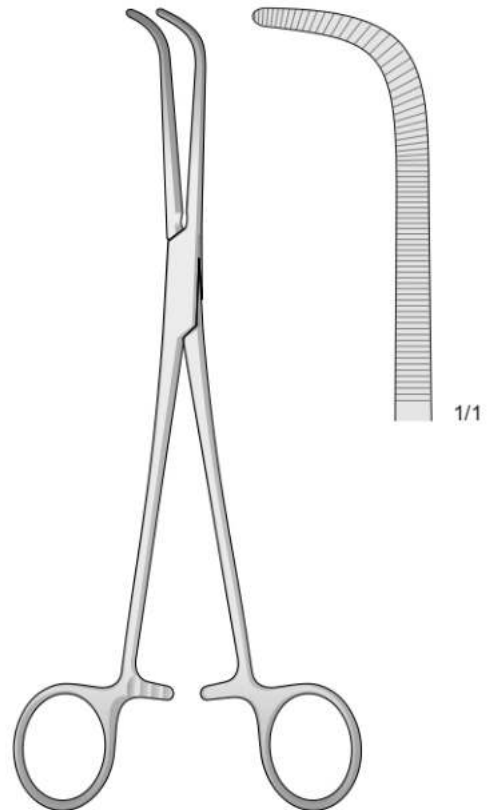
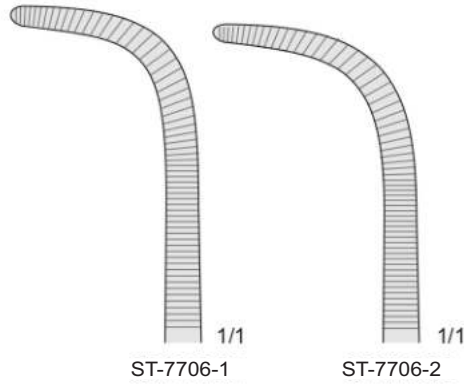
RUMEL
ST-7704
240 mm



MIXTER
ST-7705



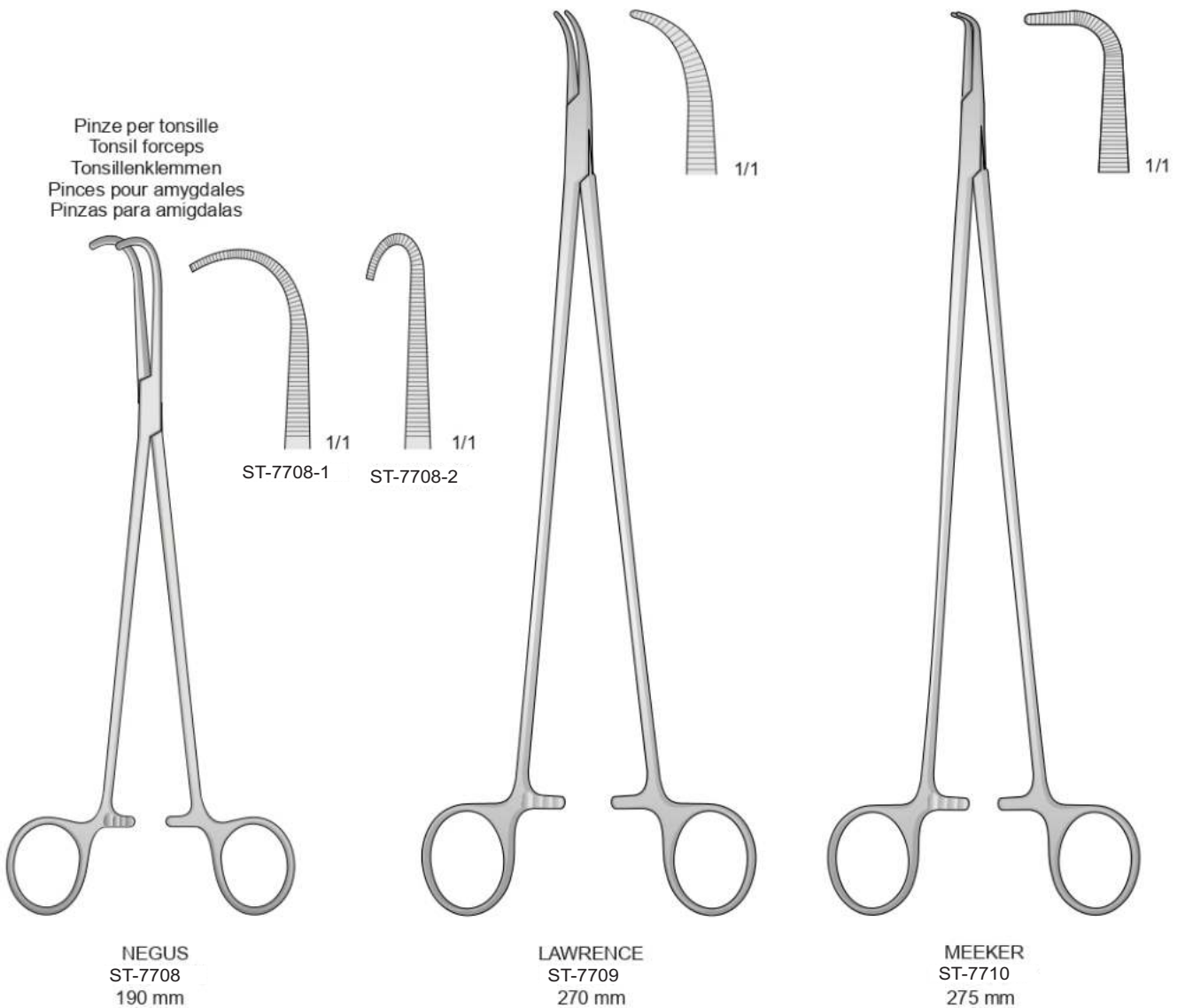
GRAY
ST-7706
220 mm

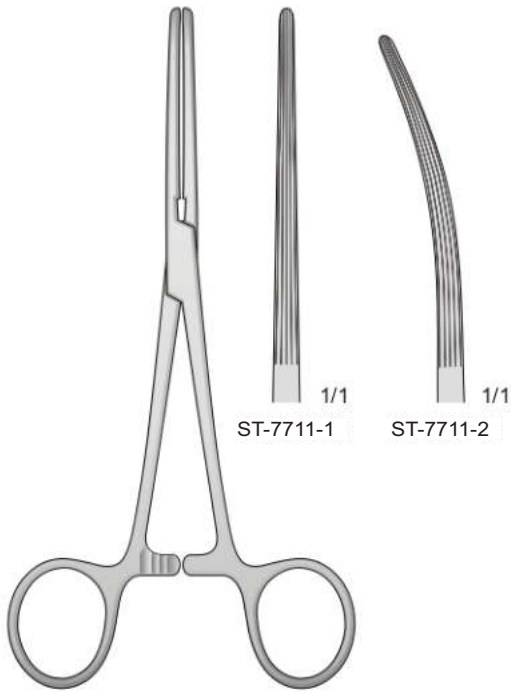


WIKSTROEM
ST-7707
205 mm

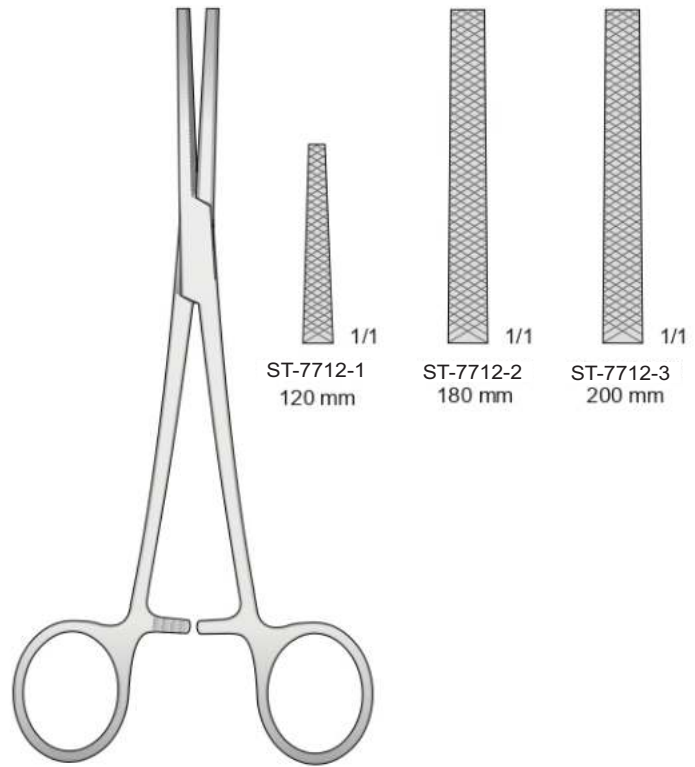


Pinze per tonsille
Tonsil forceps
Tonsillenklammen
Pinces pour amygdales
Pinzas para amígdalas



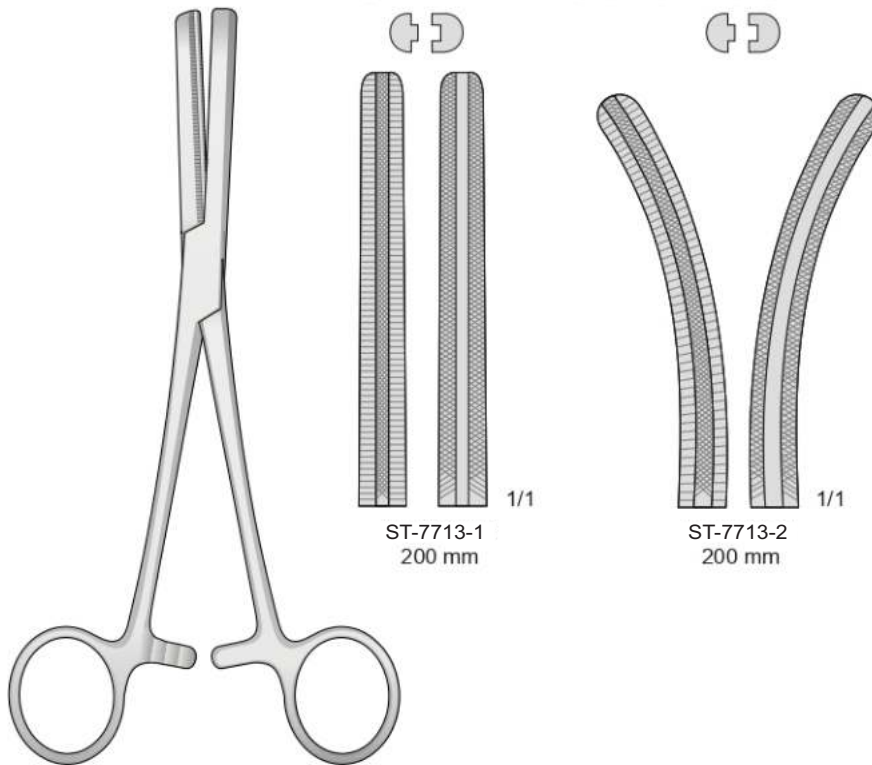


BAINBRIDGE
ST-7711
150 mm

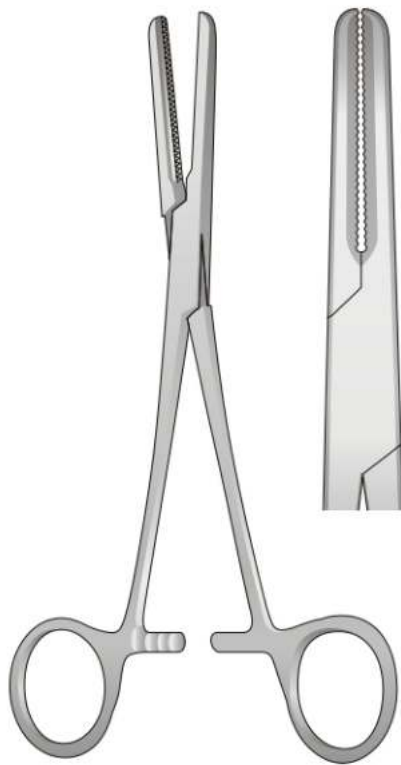


ST-7712

Angiotribe - Druckklemmen
Angiotribes - Pinzas-clamps para presión progresiva



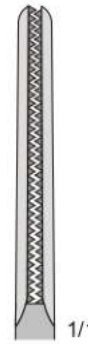
FERGUSON
ST-7713



ST-7714



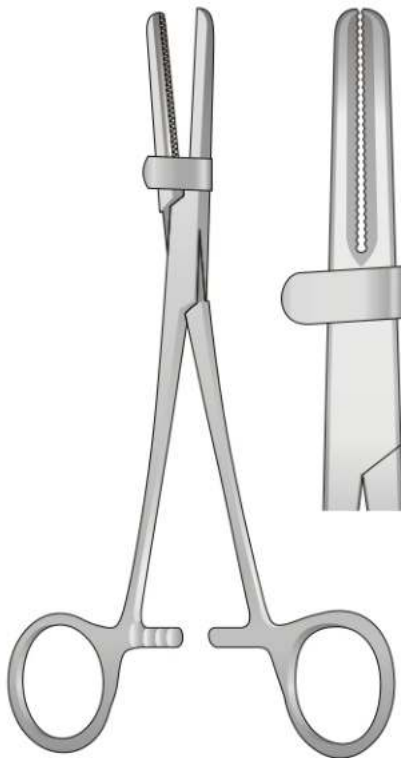
ST-7714-1
150 mm



ST-7714-2
180 mm



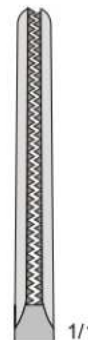
ST-7714-3
200 mm



ST-7714



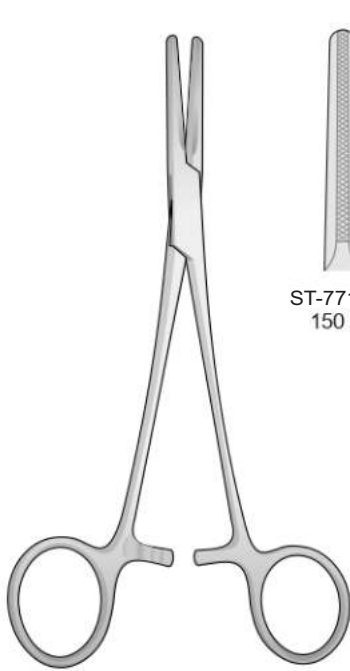
ST-7714-1
150 mm



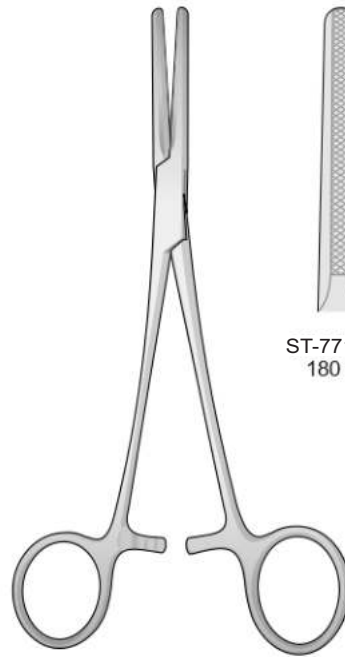
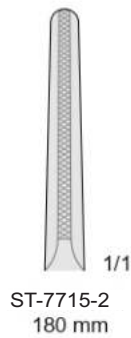
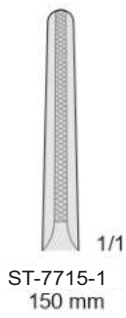
ST-7714-2
180 mm



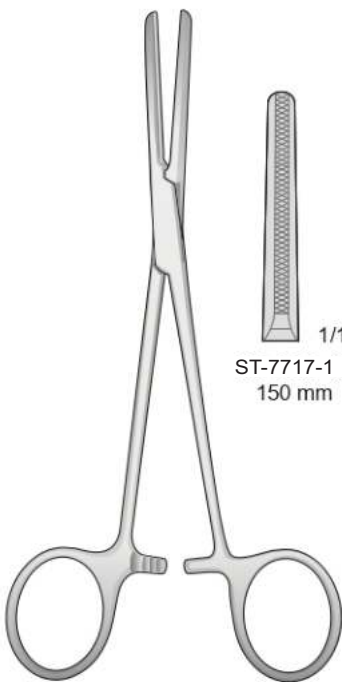
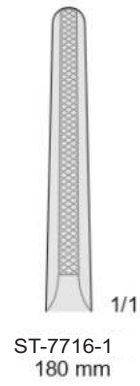
ST-7714-3
200 mm



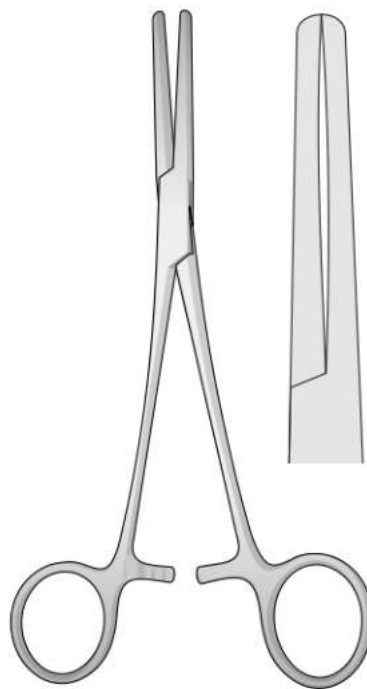
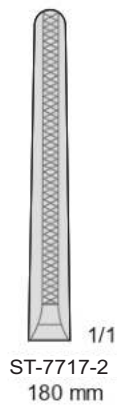
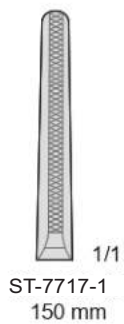
ST-7715



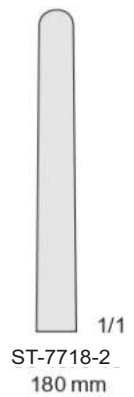
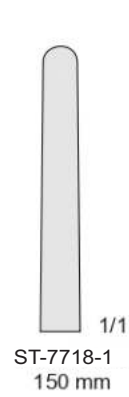
ST-7716
180 mm



ST-7717

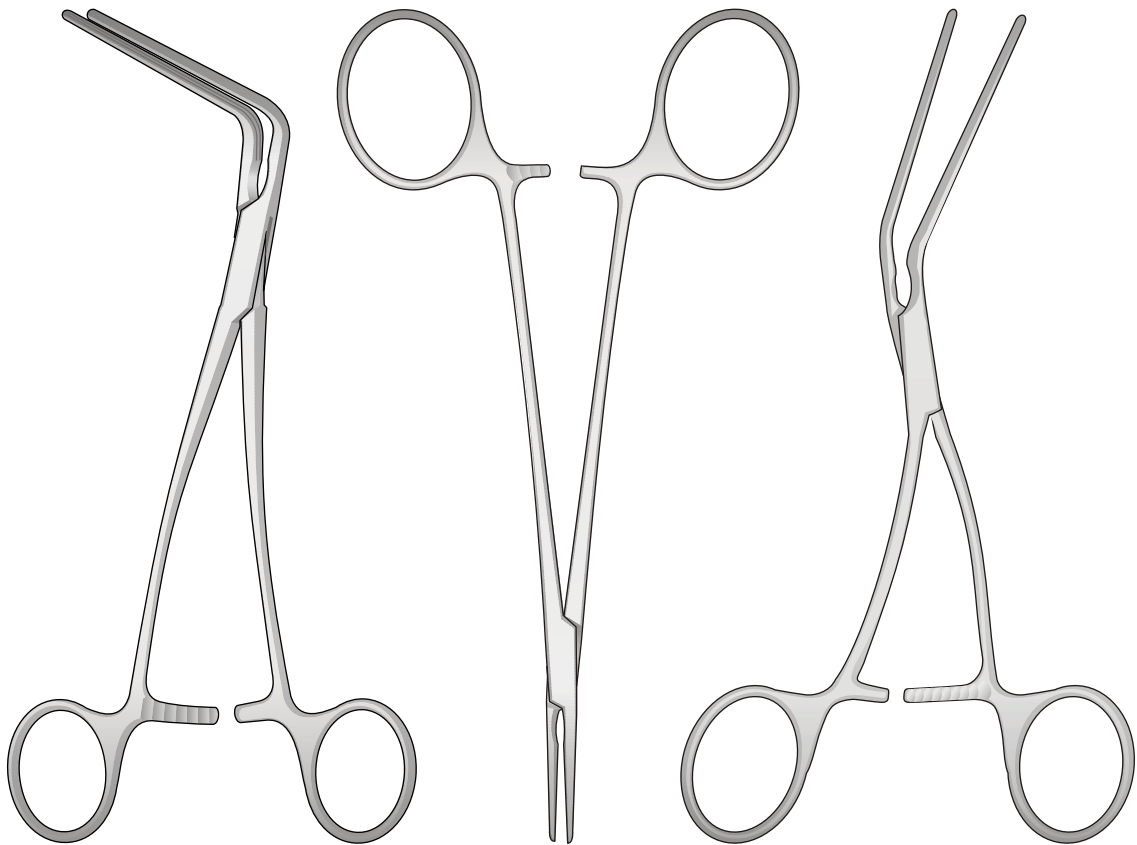


ST-7718





SAFE TOOL
MANUFACTURER & EXPORTER



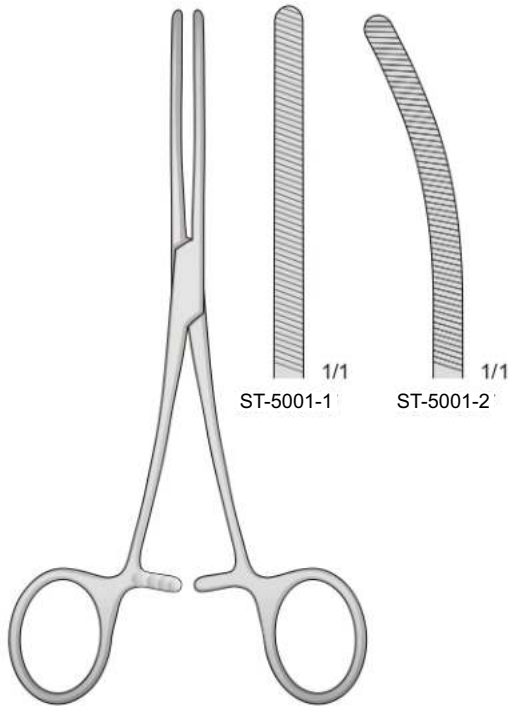
Atraumatic Vascular Clamps instruments



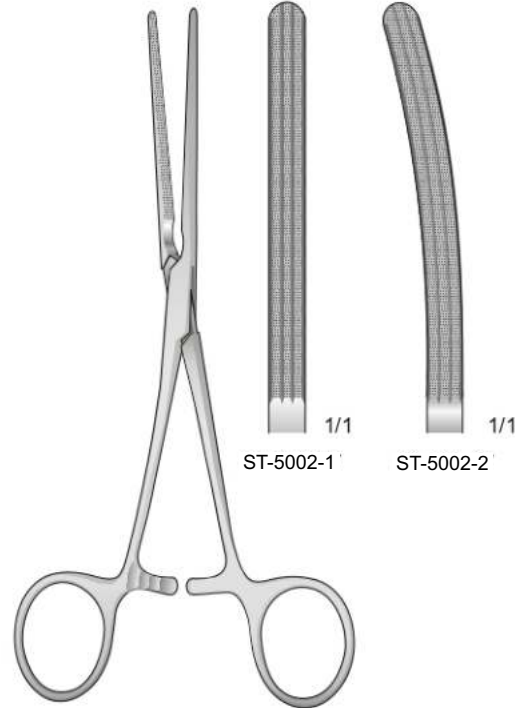
www.safetool.com.pk

***Surgical
Instruments***

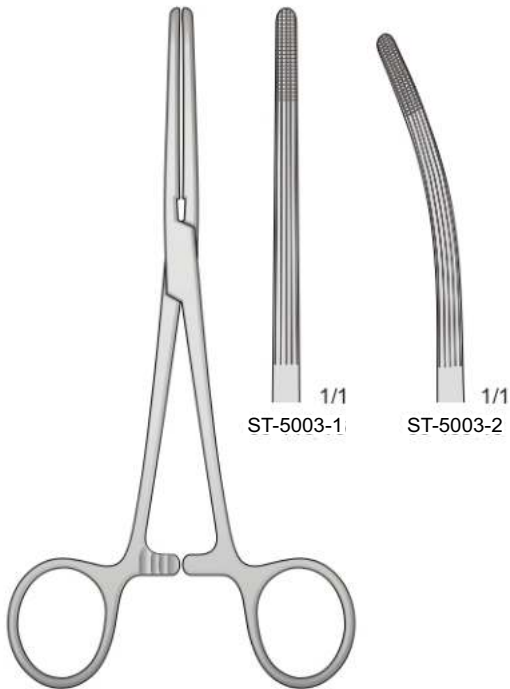
Atraumatiche - Atraumatic
Atraumatische - Atraumatiques - Atraumáticas



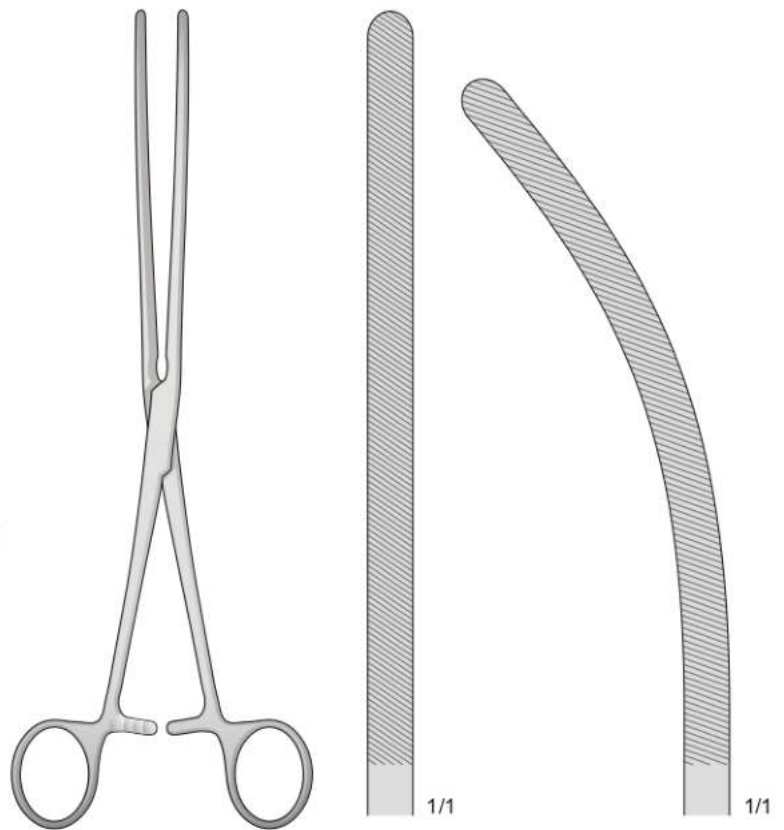
DOYEN
ST-5001
170 mm



DOYEN
ST-5002
170 mm



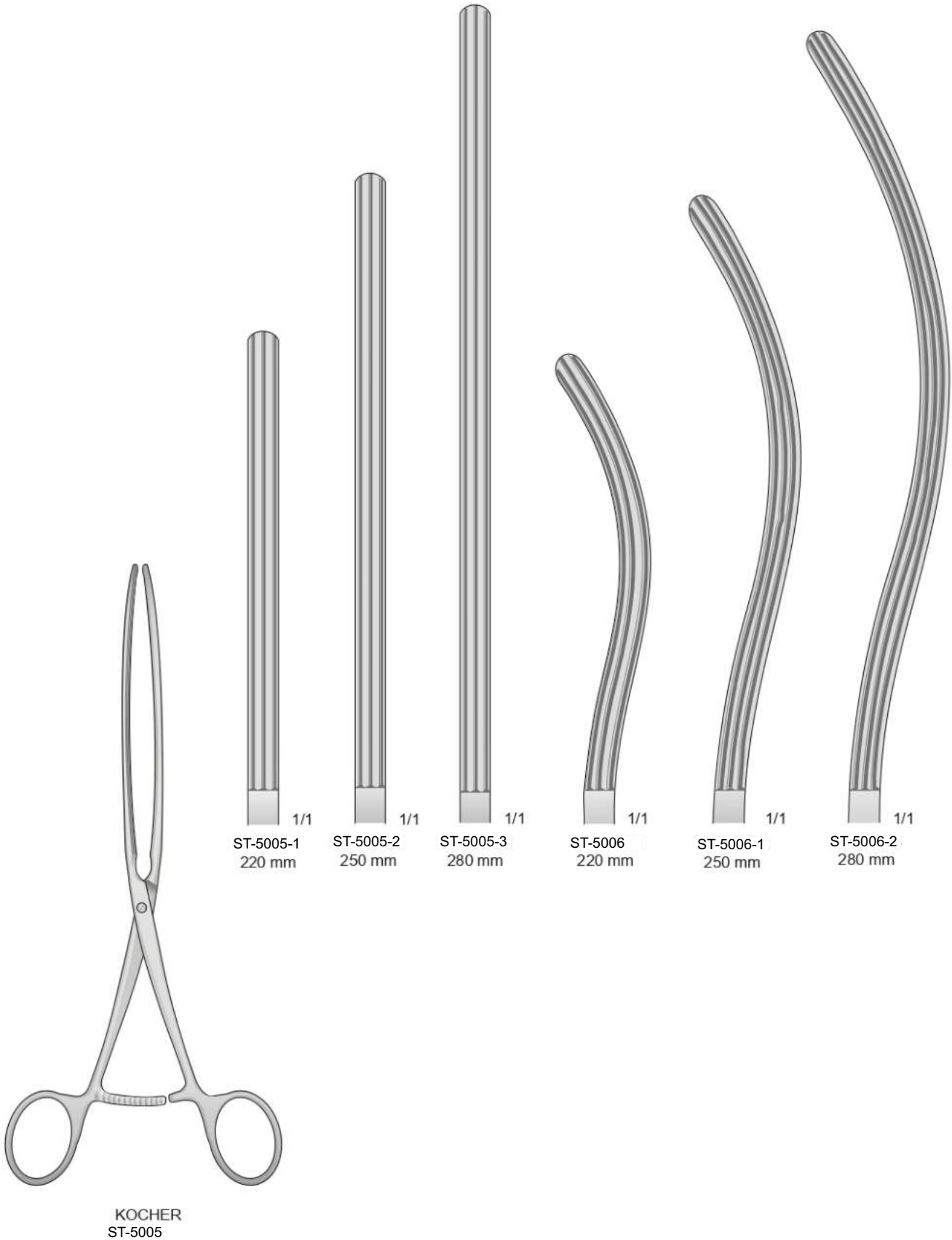
ROCHESTER-CARMALT
ST-5003
160 mm



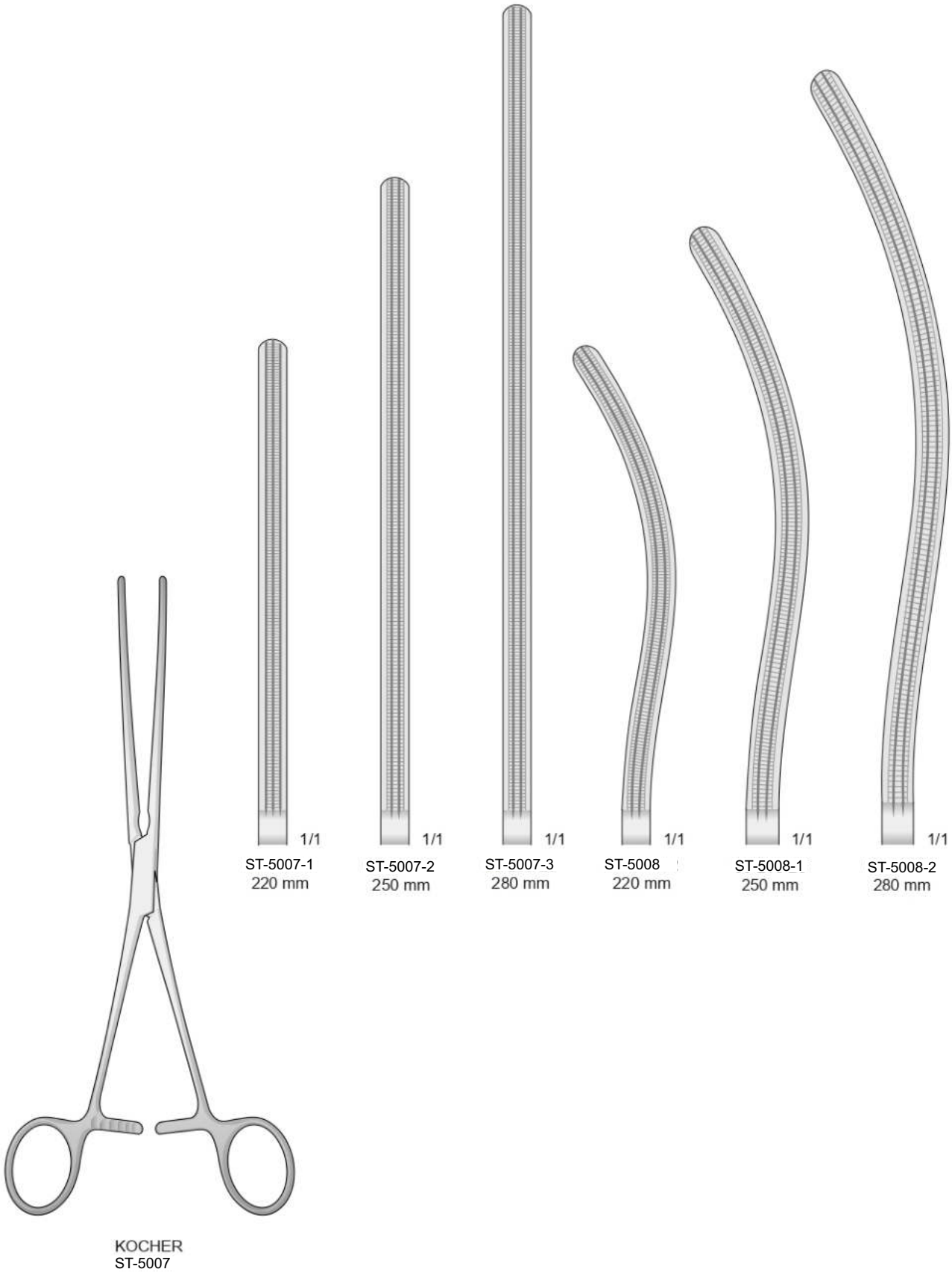
DOYEN
ST-5004
230 mm

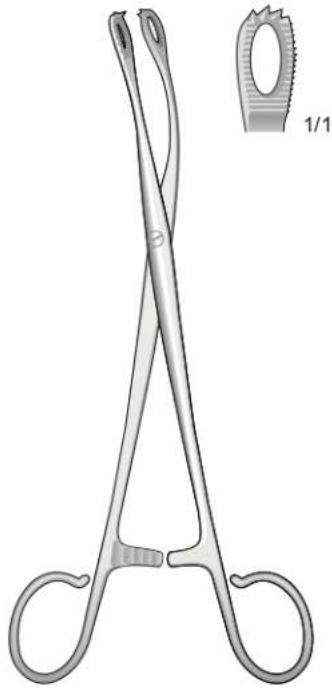


Elastiche - Elastisch - Elastich - Elastic - Elasticas

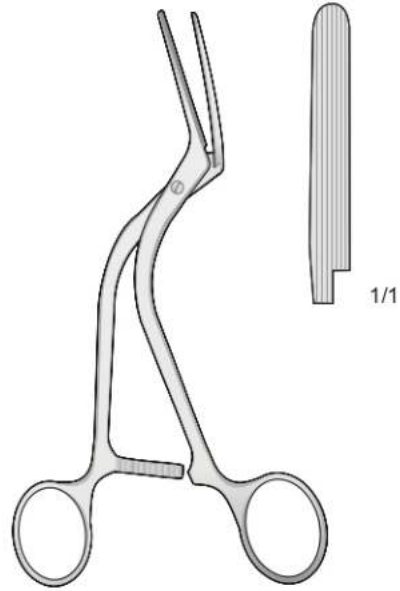


Atraumatiche - Atraumatic
Atraumatische - Atraumatiques - Atraumáticas

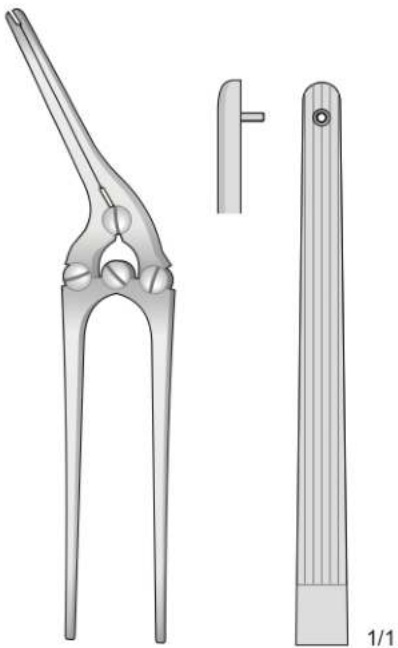




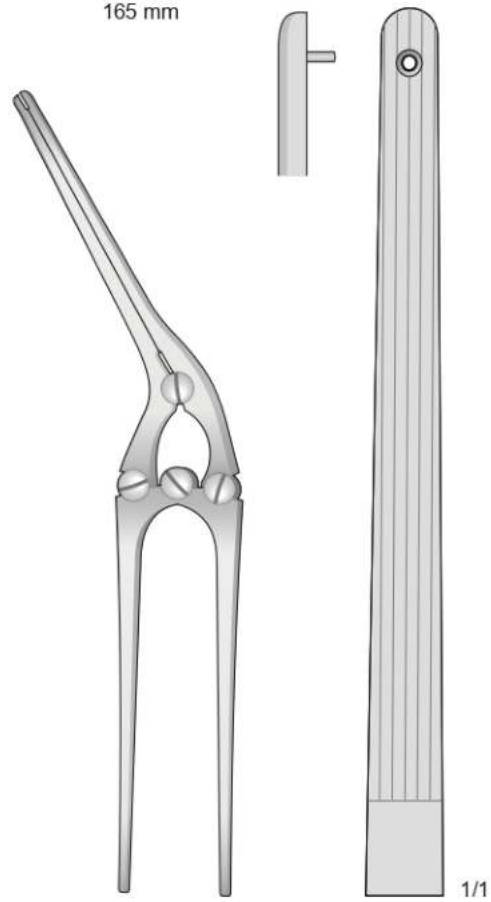
BLOHMKE
ST-5011
200 mm



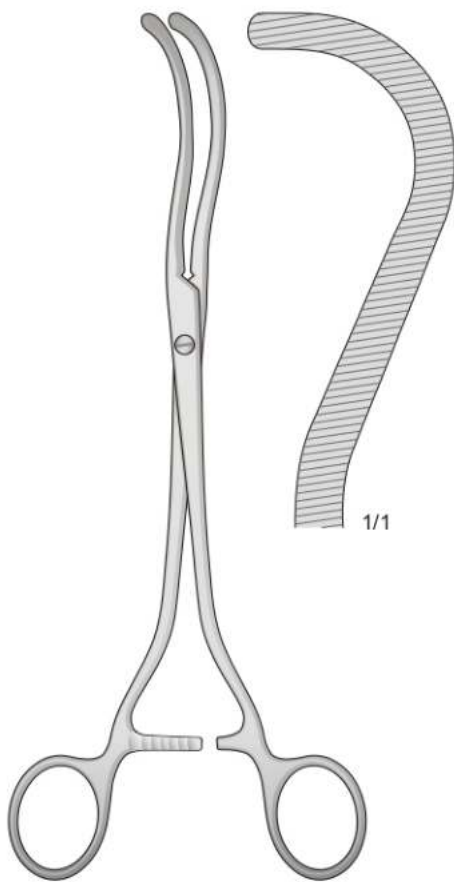
HÖPFNER
ST-5012
165 mm



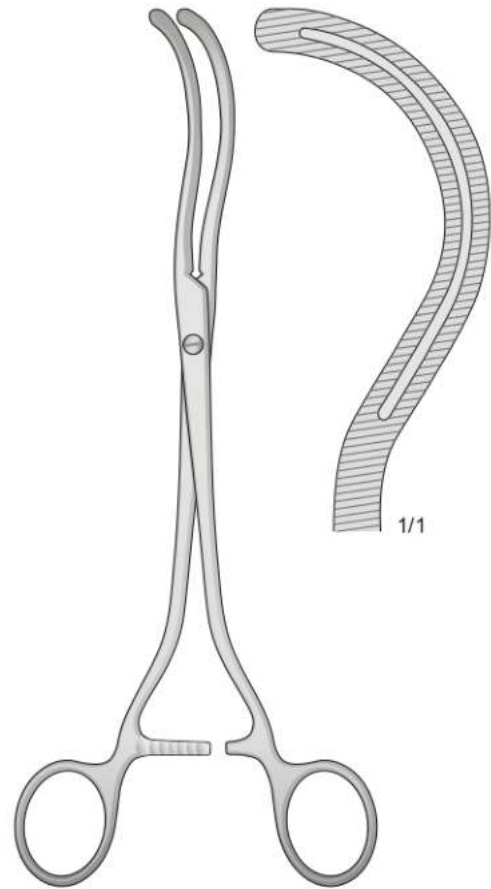
PAYR
ST-5009
200 mm



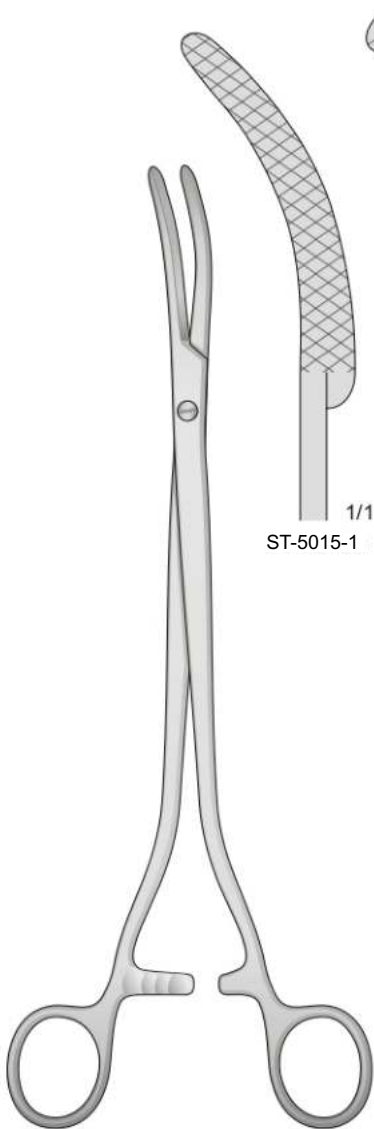
PAYR
ST-5010
280 mm



GUYON
ST-5013
235 mm

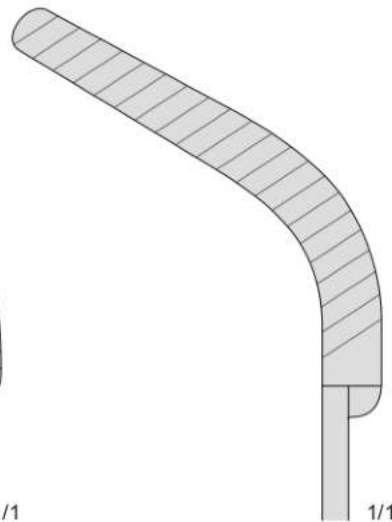


STILLE
ST-5014
240 mm

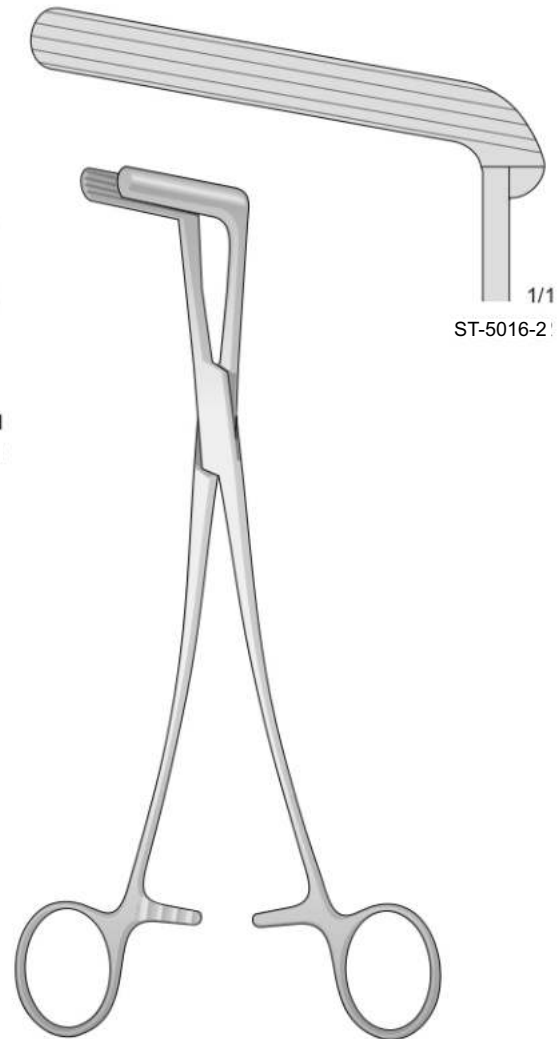


ST-5015-1

WERTHEIM
ST-5015
260 mm



ST-5016-1

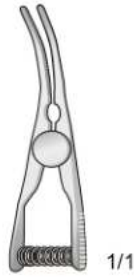


ST-5016-2

WERTHEIM
ST-5016
235 mm



ST-5024-1
35 mm



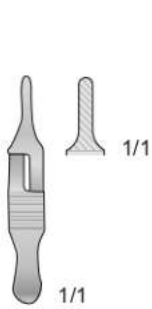
ST-5025-1
35 mm



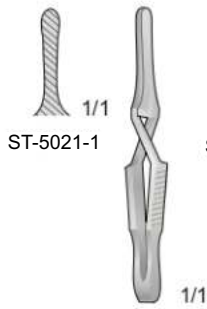
ST-5024-2
45 mm



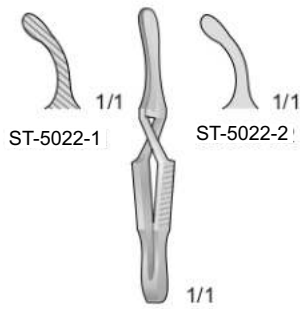
ST-5025-2
45 mm



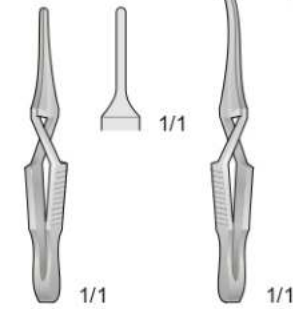
ST-5020
30 mm



DIFFENBACH
ST-5021
40 mm



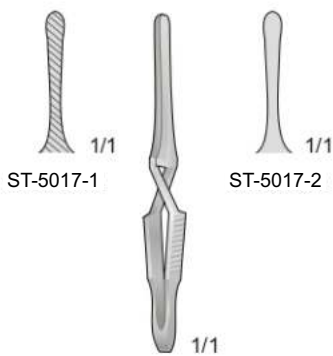
DIFFENBACH
ST-5022
40 mm



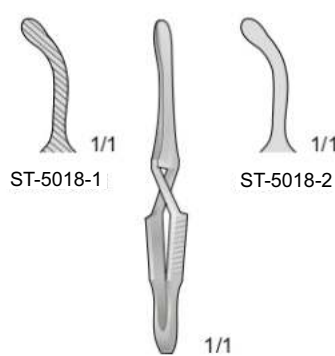
ST-5023-1
40 mm



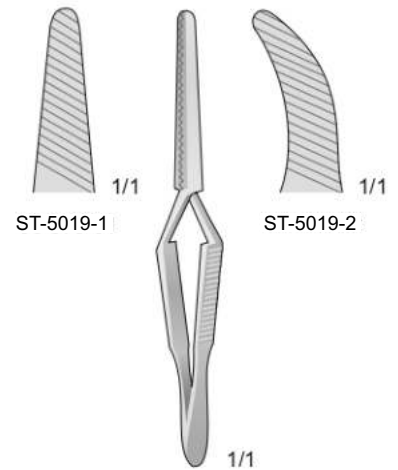
ST-5023-2
45 mm



DIFFENBACH
ST-5017
45 mm



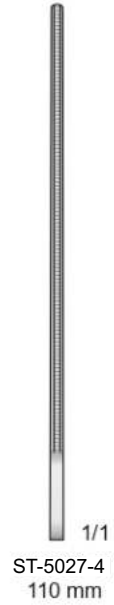
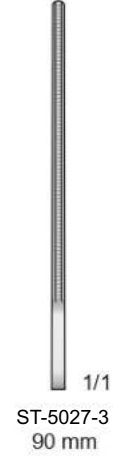
DIFFENBACH
ST-5018
45 mm



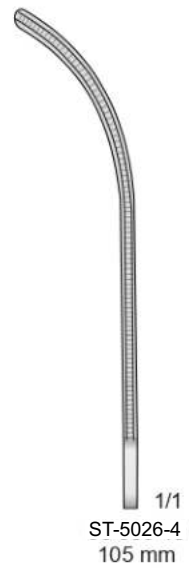
DIFFENBACH
ST-5019
60 mm



GLOVER
ST-5027

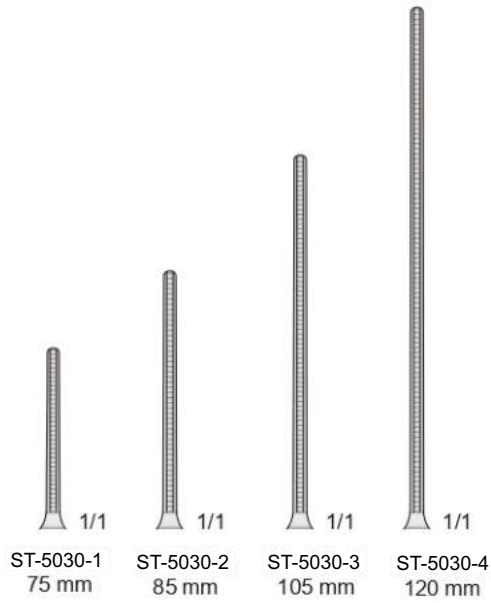


GLOVER
ST-5026





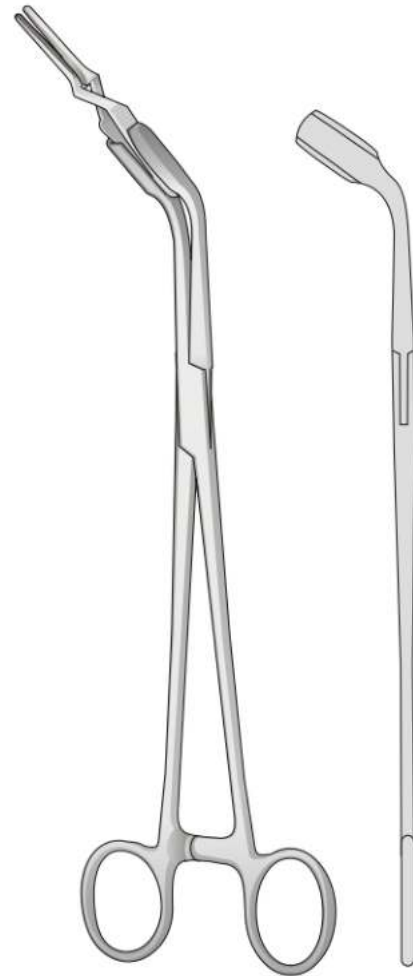
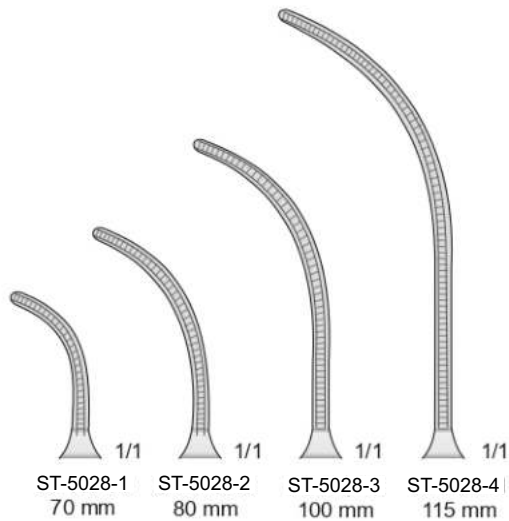
ST-5030



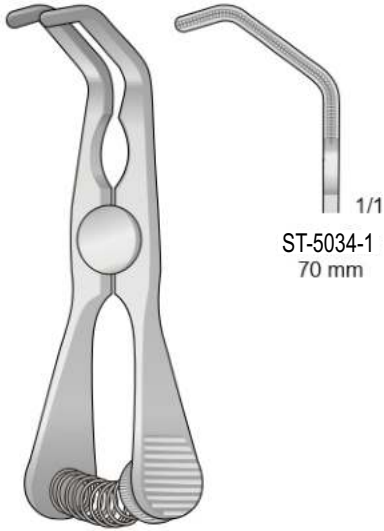
Pinza per applicare e rimuovere Bulldog clamps
Zange zum ansetzen der Bulldogklemmen
Forceps for applying and removing Bulldog clamps
Pinces pour applicateur clamps Bulldog
Pinzas de aplicación para pinzas Bulldog



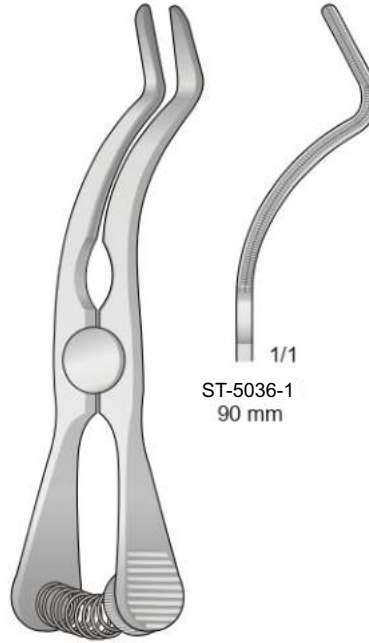
ST-5028



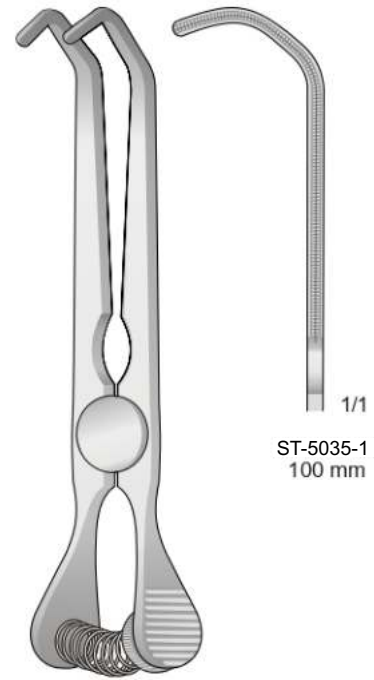
ST-5029
230 mm



DE BAKY-SATINSKY
ST-5034
70 mm



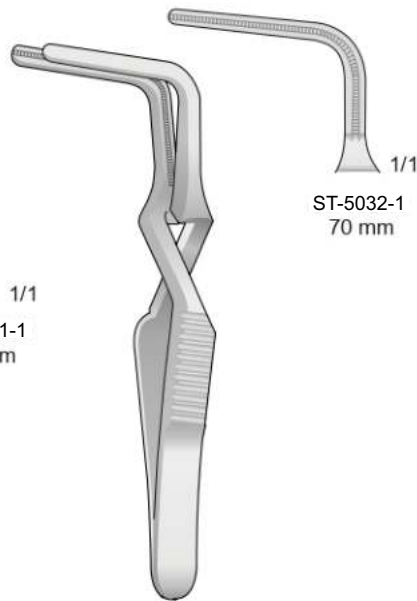
DE BAKY-CAROTIS
ST-5036
90 mm



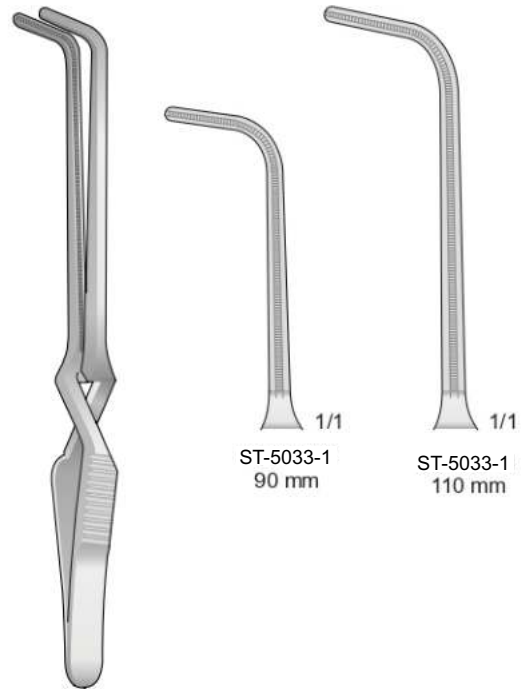
DE BAKY-SATINSKY
ST-5035
100 mm



GLOVER
ST-5031
50 mm



SANTULLI
ST-5032
70 mm



06-460

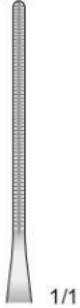
ST-5033-1
90 mm

ST-5033-1
110 mm



Pinze atraumatiche per neonati e bambini
Atraumatic Vessel clamps for babys and children
Atraumatische Gefäßklemmen für Säuglinge und Kinder
Pinces vasculaires atraumatiques pour enfants
Pinzas vasculares atraumáticas para niños

Modelli estremamente fini
Delicate - Fein - Fins - Finas



ST-5037-1
140 mm



ST-5037-2
140 mm



ST-5037-3
140 mm



ST-5037-4
130 mm



ST-5037-5
140 mm



ST-5037-6
130 mm



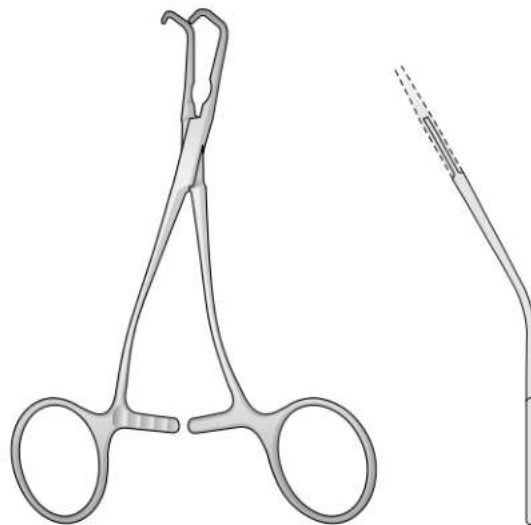
ST-5037-7
130 mm



ST-5037-8
140 mm

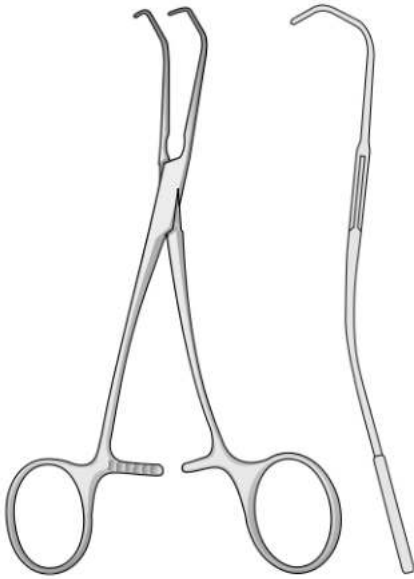


ST-5037-9
135 mm

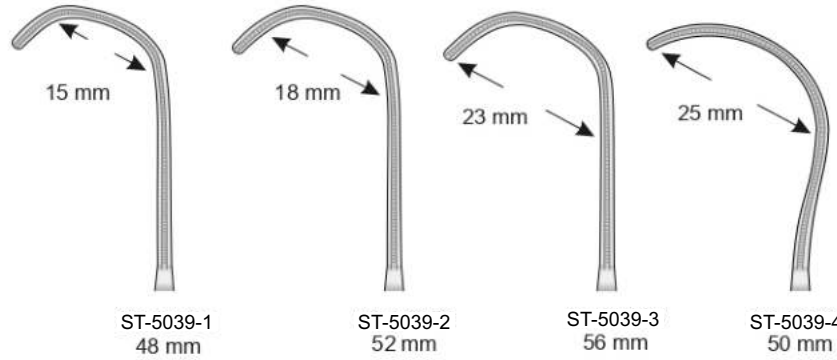


ST-5037
130 mm

Atraumatic
Atraumatic
Atraumatische
Atraumatiques
Atraumaticas



CASTANEDA
ST-5039
155 mm

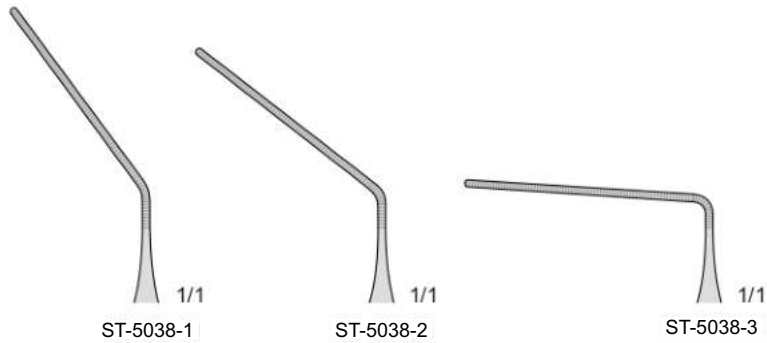


ST-5039-1
48 mm

ST-5039-2
52 mm

ST-5039-3
56 mm

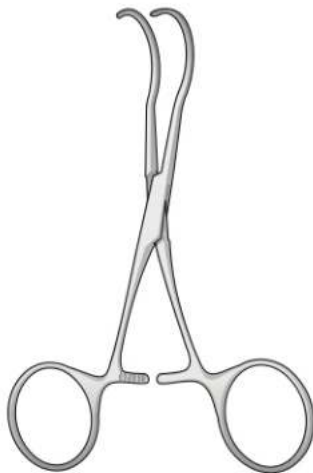
ST-5039-4
50 mm



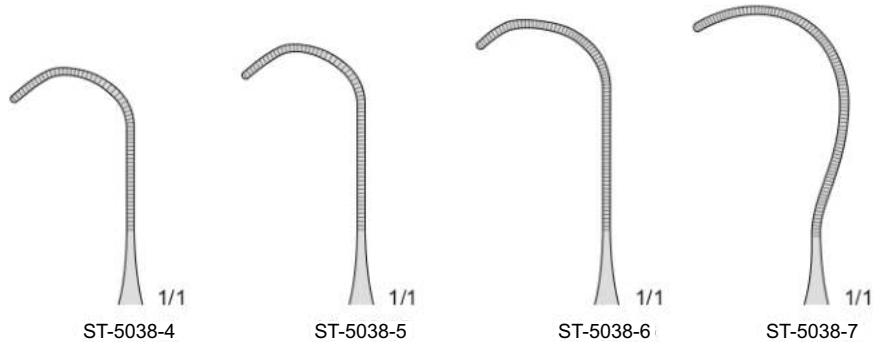
ST-5038-1

ST-5038-2

ST-5038-3



CASTANEDA
ST-5038
120 mm



ST-5038-4

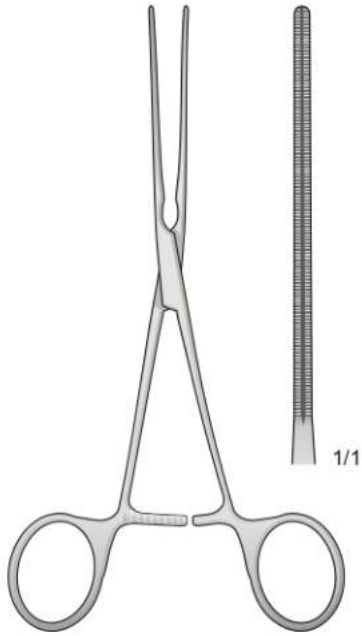
ST-5038-5

ST-5038-6

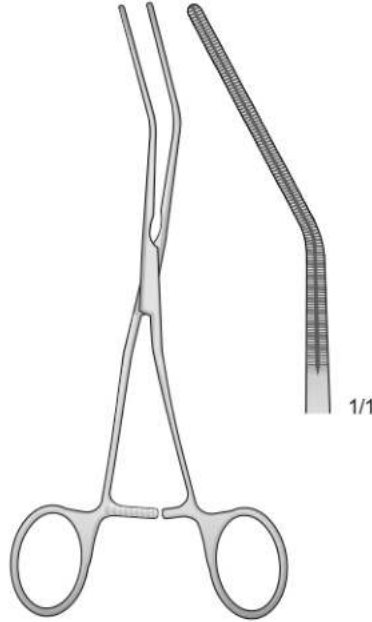
ST-5038-7



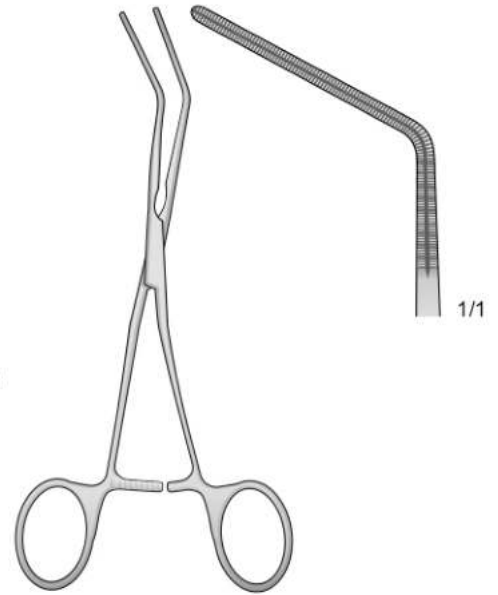
Pinze per neonati e bambini
Atraumatic vessel clamps for babys and children
Sugling - und Kinderklemmen
Pinces-clamps pour nouveaux-nes et enfants
Pinzas vasculares atraumaticas para nios



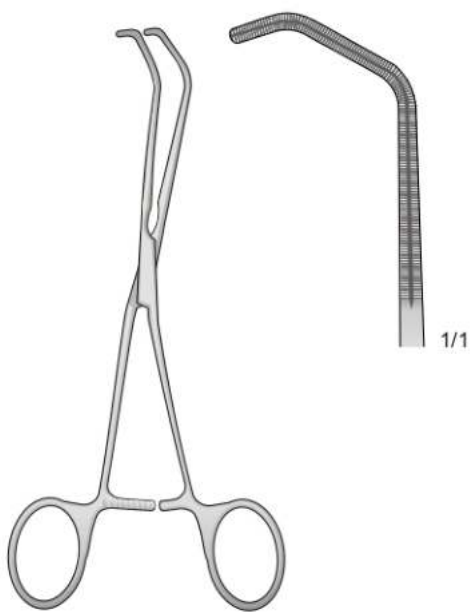
ST-5042
165 mm



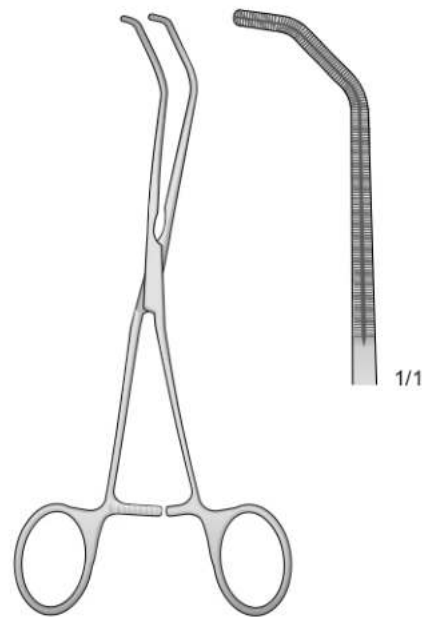
ST-5043
160 mm



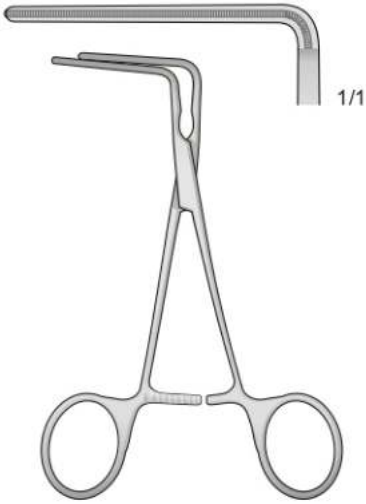
ST-5044
150 mm



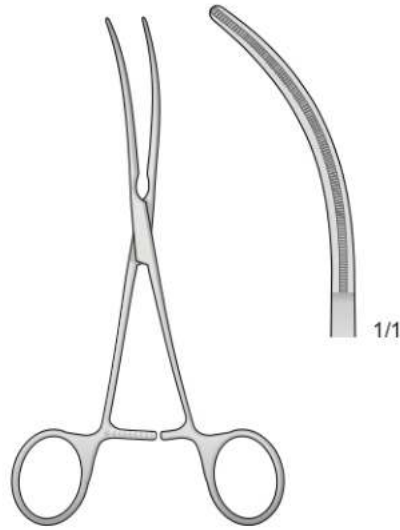
ST-5040
150 mm



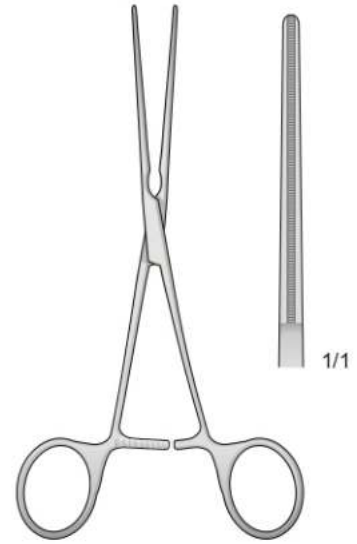
ST-5041
155 mm



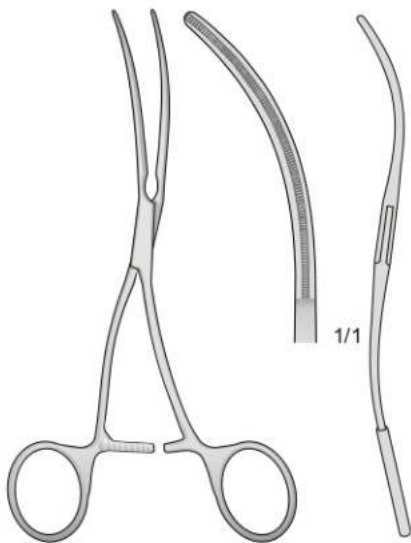
De BAKEY
ST-5047
100 mm



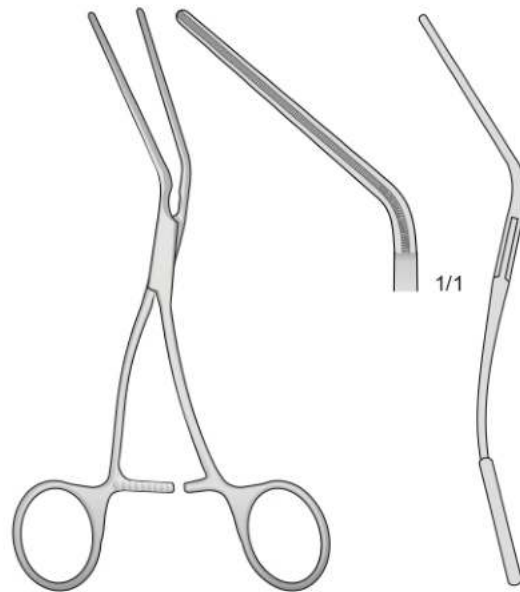
De BAKEY
ST-5048
110 mm



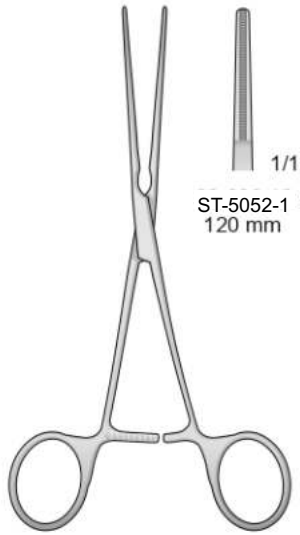
De BAKEY
ST-5049
120 mm



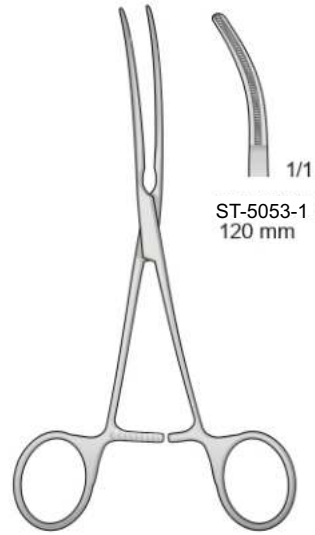
De BAKEY
ST-5045
120 mm



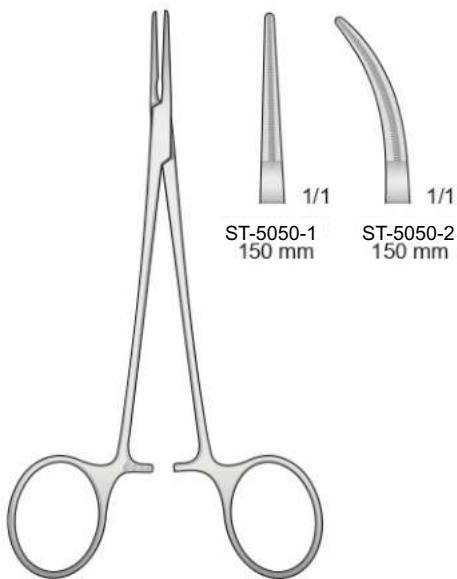
De BAKEY
ST-5046
130 mm



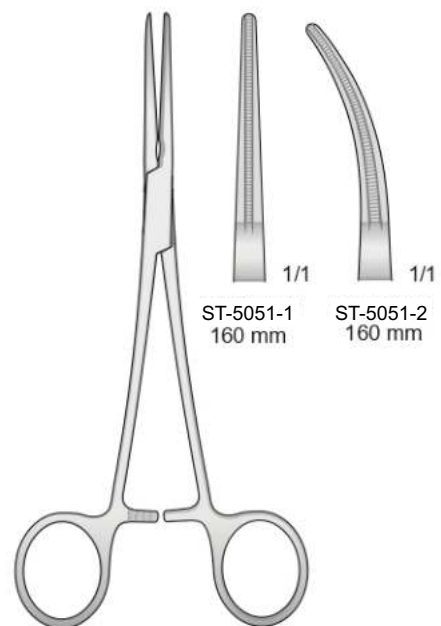
De BAKEY - MOSQUITO
ST-5052
120 mm



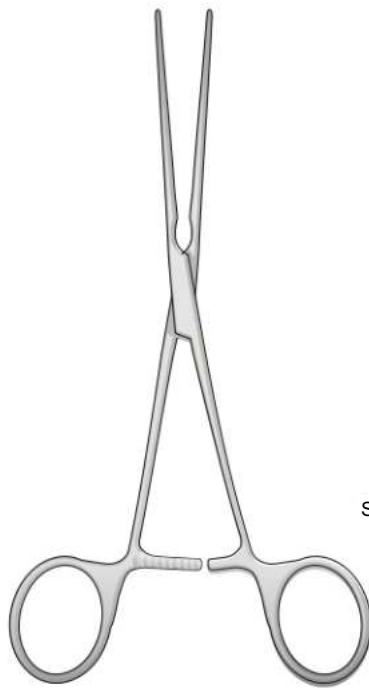
De BAKEY - MOSQUITO
ST-5053
120 mm



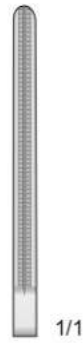
De BAKEY - MOSQUITO
ST-5050
150 mm



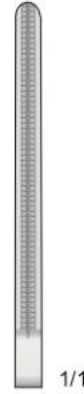
De BAKEY - RANKIN
ST-5051
160 mm



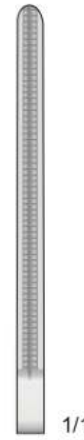
De BAKEY - PEAN
ST-5055



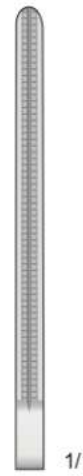
ST-5055-1
140 mm



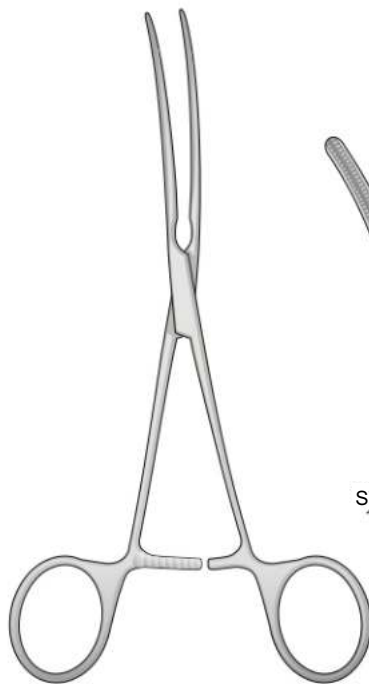
ST-5055-2
160 mm



ST-5055-3
180 mm



ST-5055-4
200 mm



De BAKEY - PEAN
ST-5054



ST-5054-1
140 mm



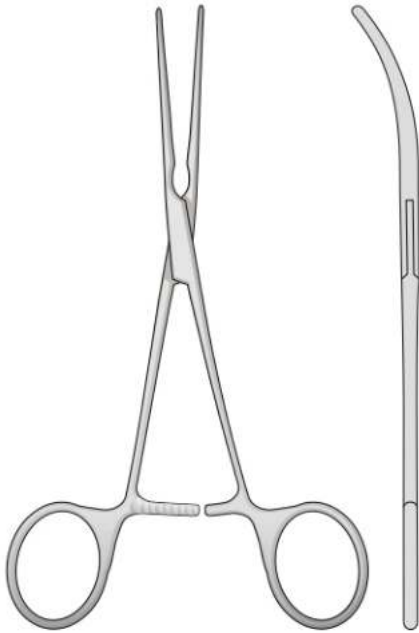
ST-5054-2
160 mm



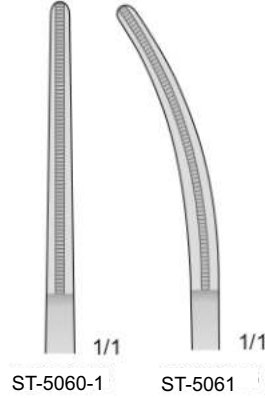
ST-5054-3
180 mm



ST-5054-4
200 mm

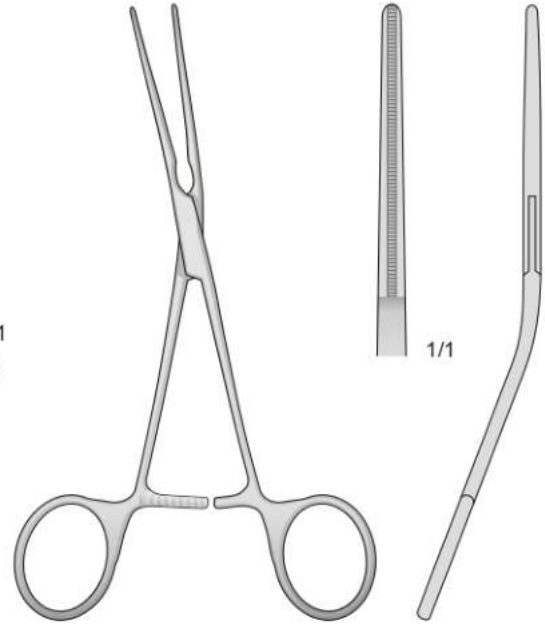


De BAKEY
ST-5060
165 mm

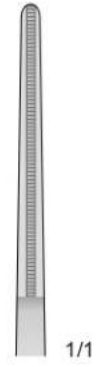


ST-5060-1

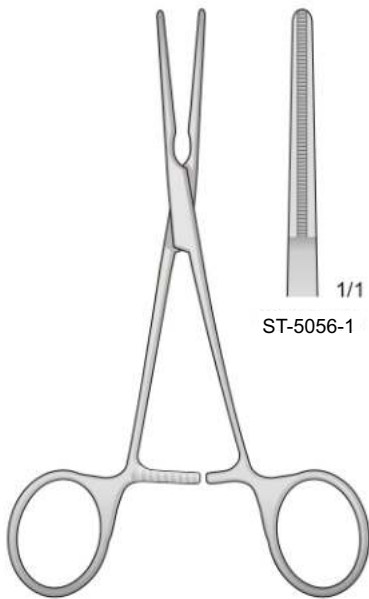
ST-5061



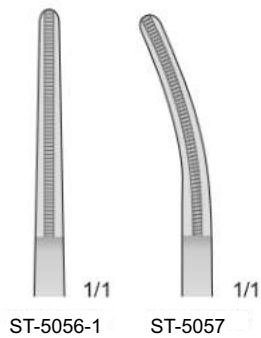
De BAKEY
ST-5062
165 mm



1/1

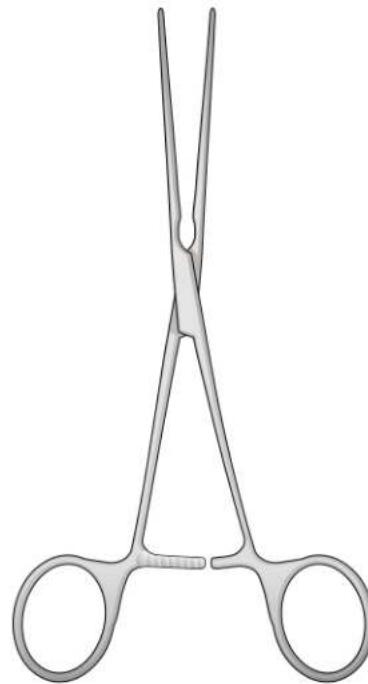


De BAKEY - BAINBRIDGE
ST-5056
155 mm

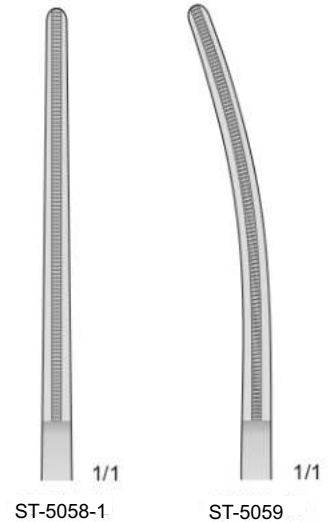


ST-5056-1

ST-5057

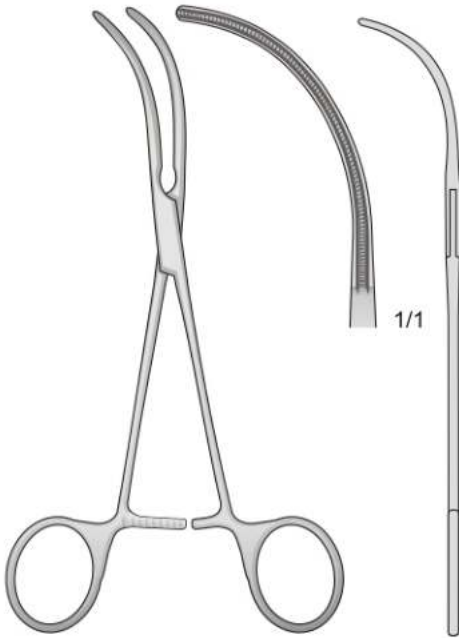


De BAKEY - BAINBRIDGE
ST-5058
180 mm

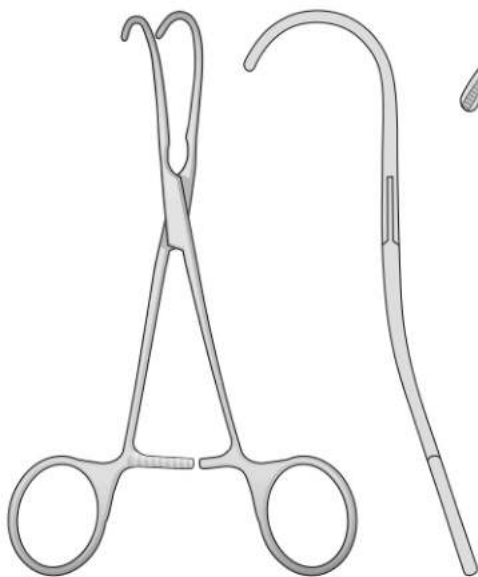


ST-5058-1

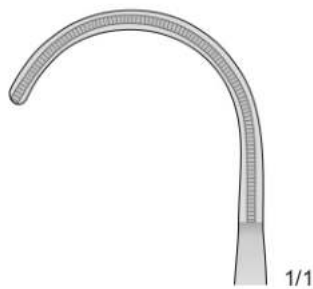
ST-5059



De BAKEY
ST-5064
160 mm



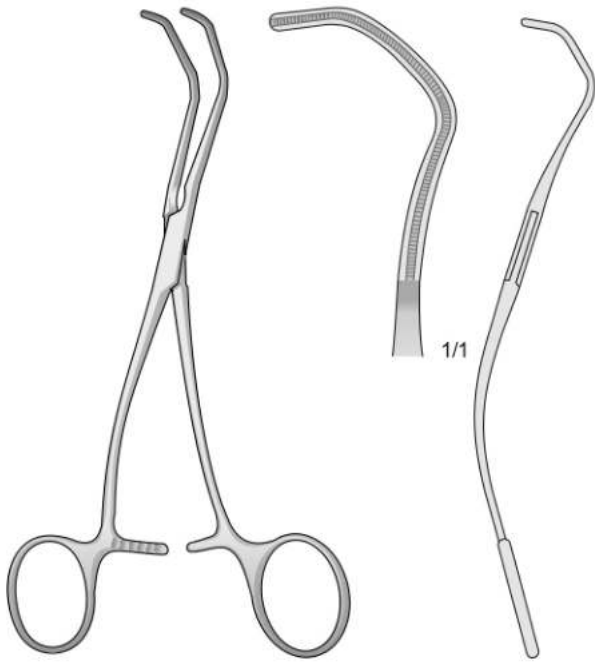
De BAKEY
ST-5063
150 mm



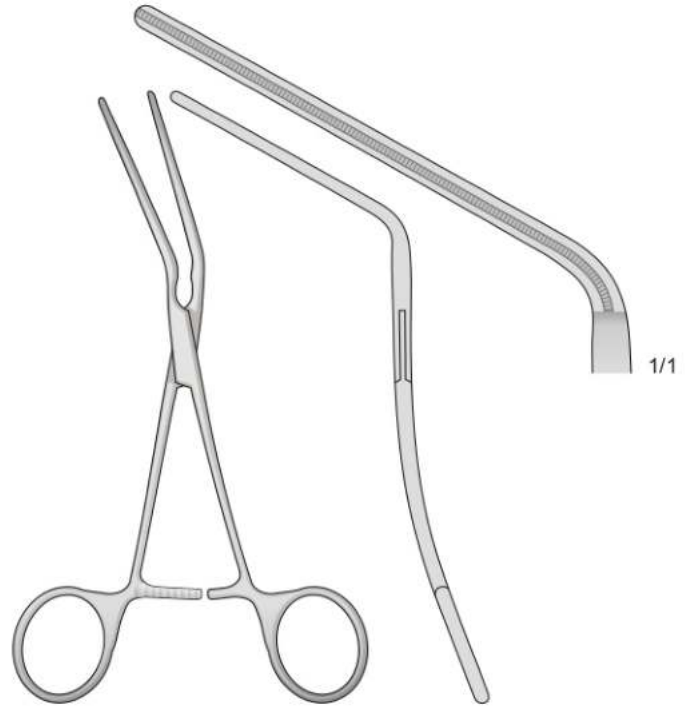
ST-5063-1



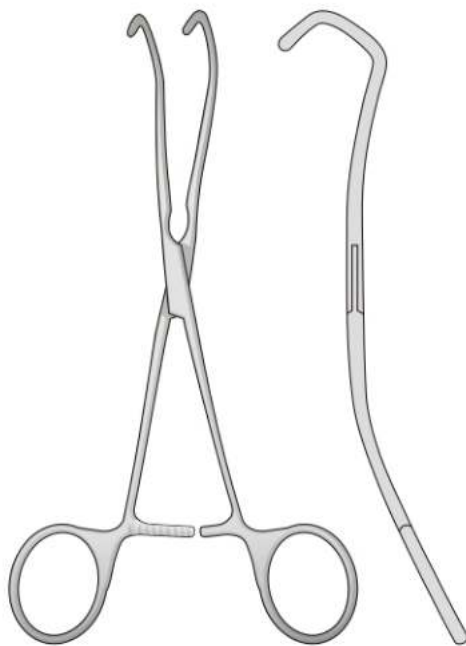
ST-5063-2



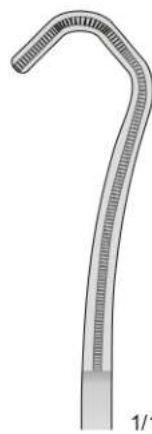
De-BAKEY
ST-5066
170 mm



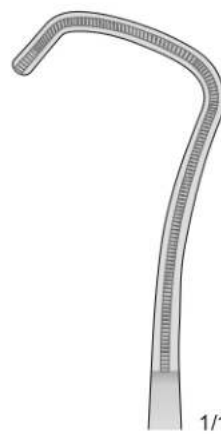
De BAKEY
ST-5067
165 mm



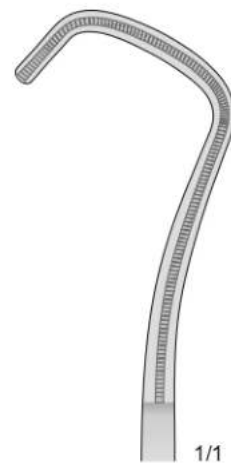
DERRA
ST-5065
170 mm



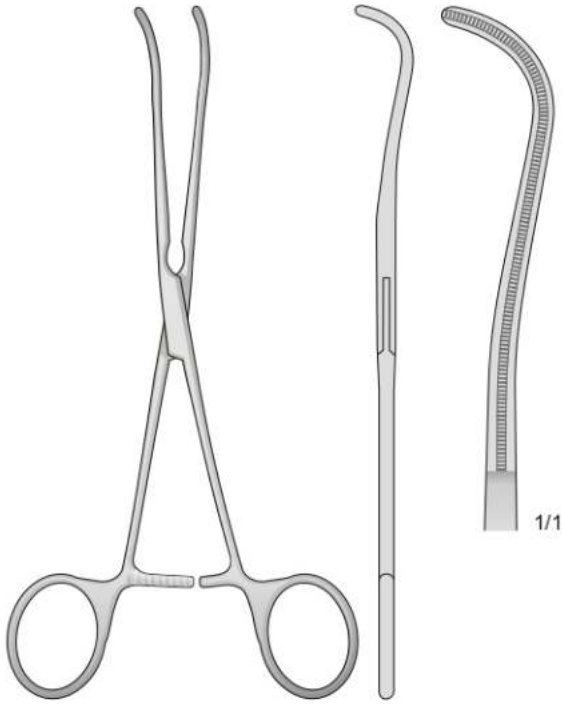
ST-5065-1



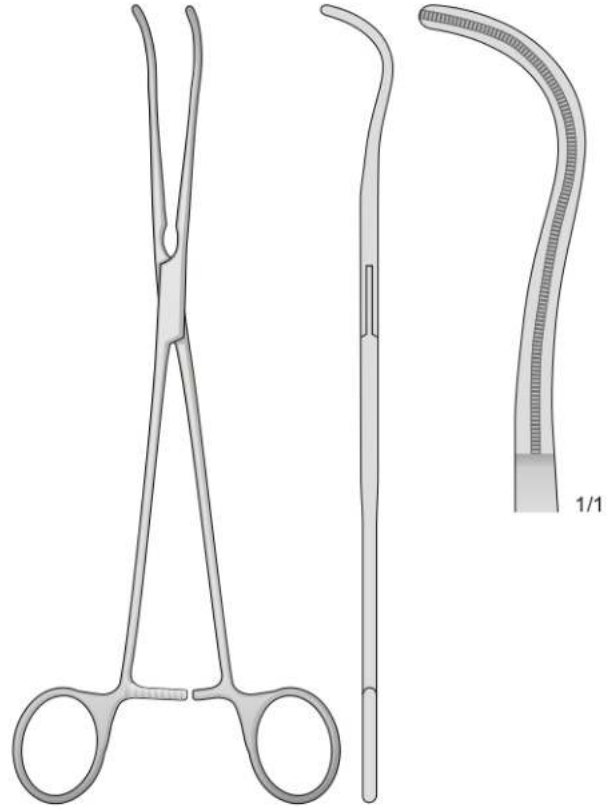
ST-5065-2



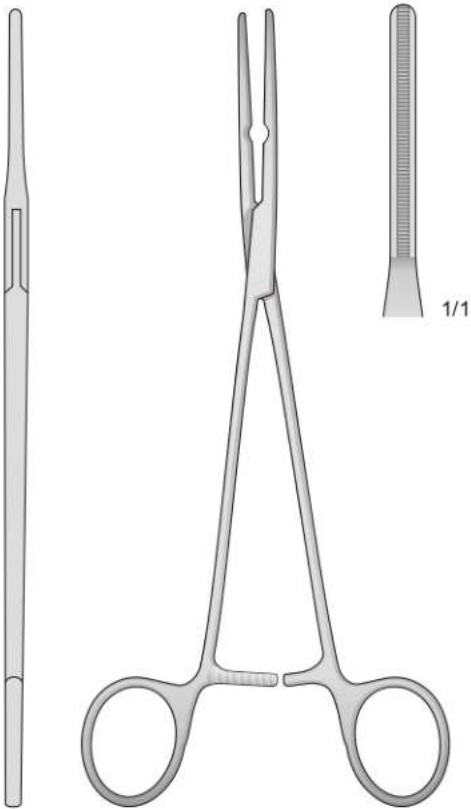
ST-5065-3



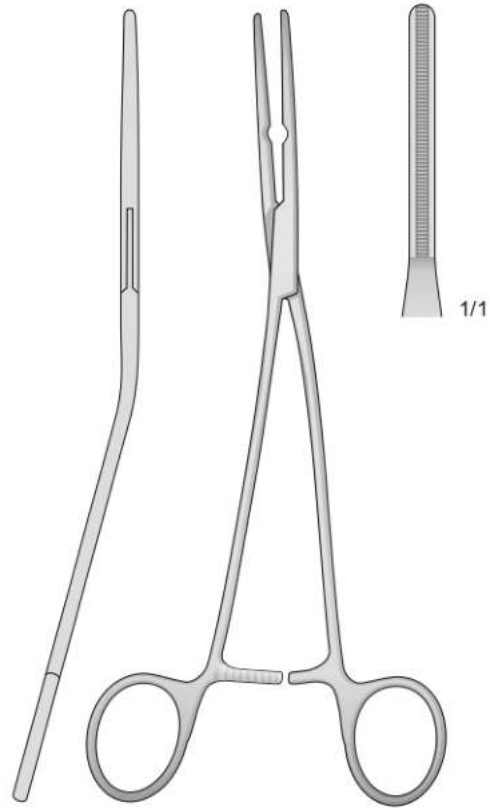
De BAKEY
ST-5070
190 mm



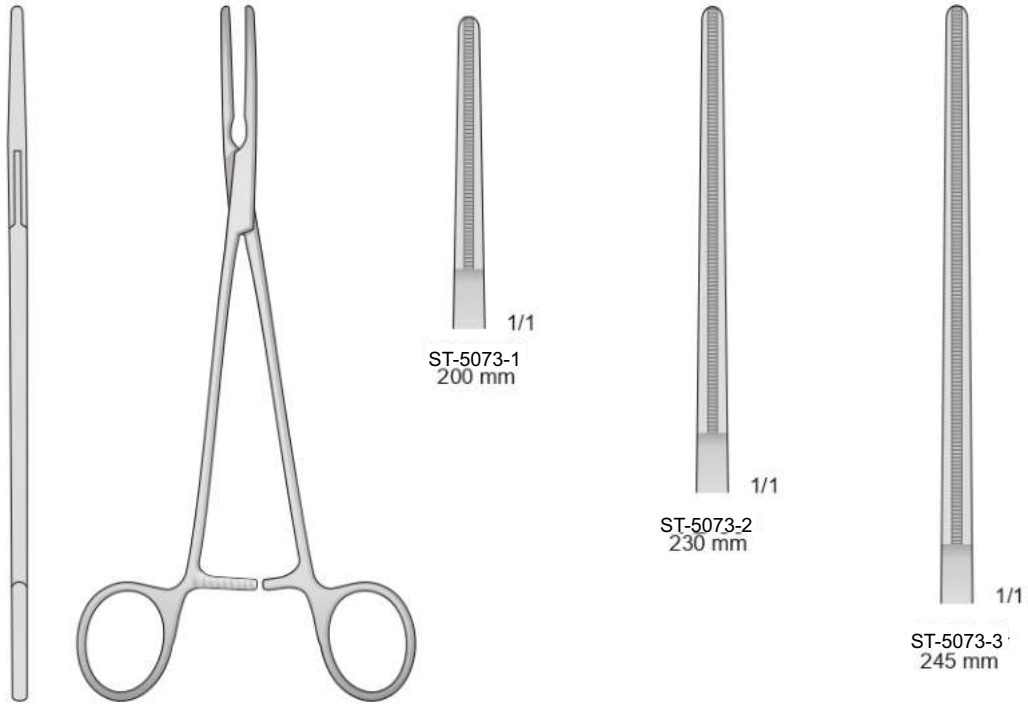
De BAKEY
ST-5071
230 mm



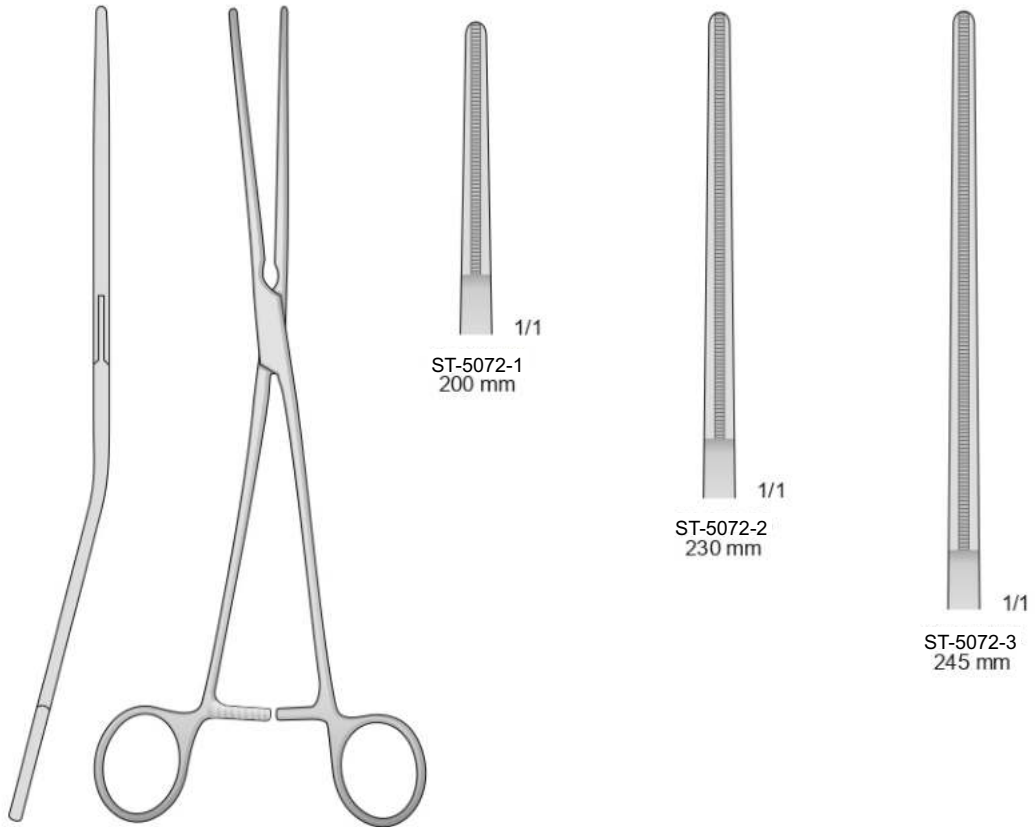
De BAKEY
ST-5068
215 mm



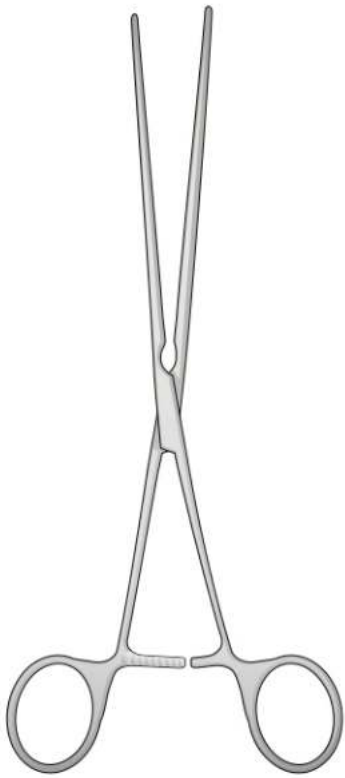
De BAKEY
ST-5069
215 mm



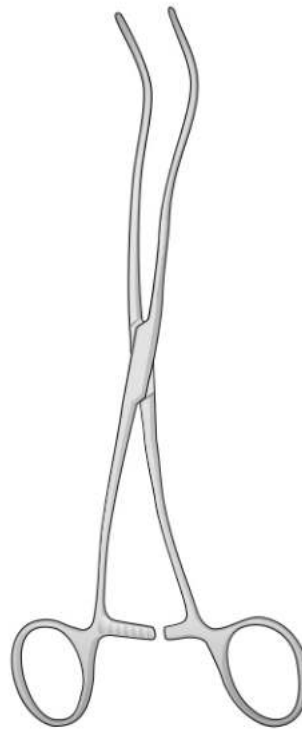
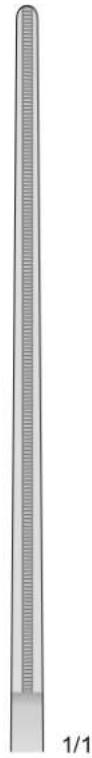
De BAKEY
ST-5073



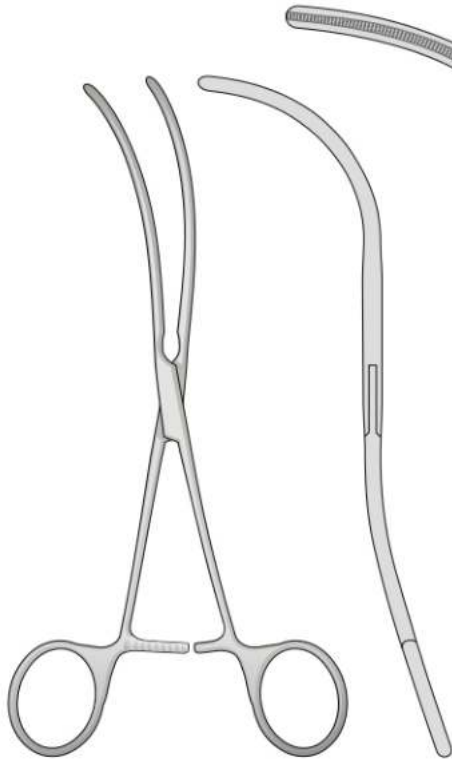
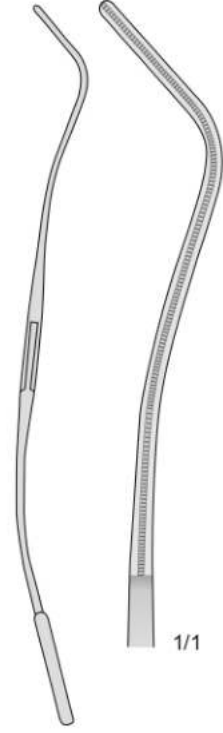
De BAKEY
ST-5072



De BAKEY
ST-5076
220 mm

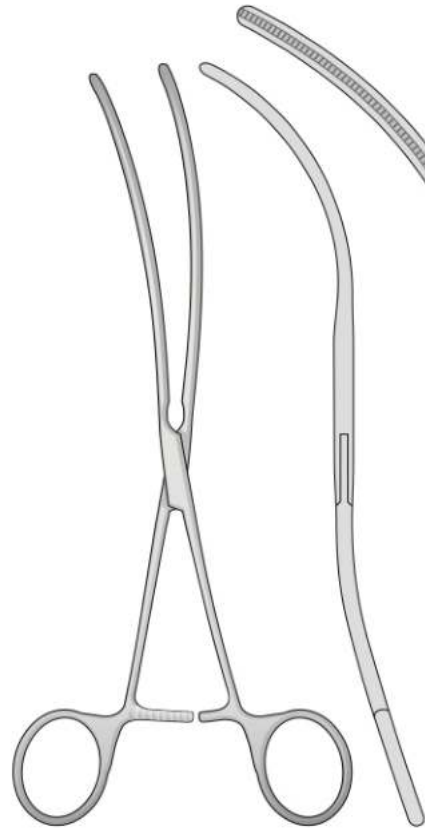


De BAKEY
ST-5077
200 mm



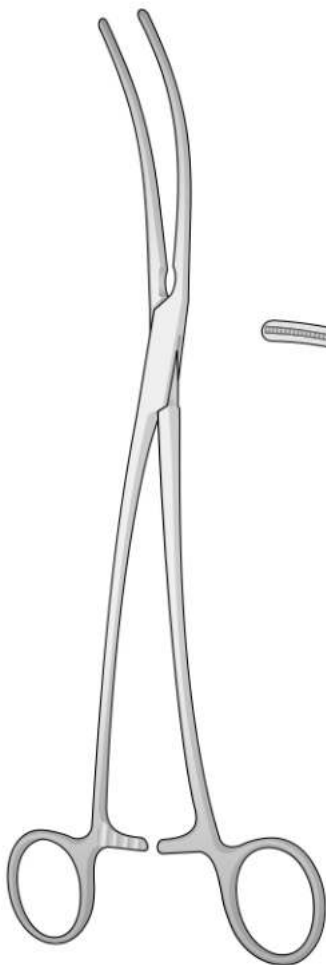
De BAKEY
ST-5074 -
180 mm

1/1
ST-5074-1

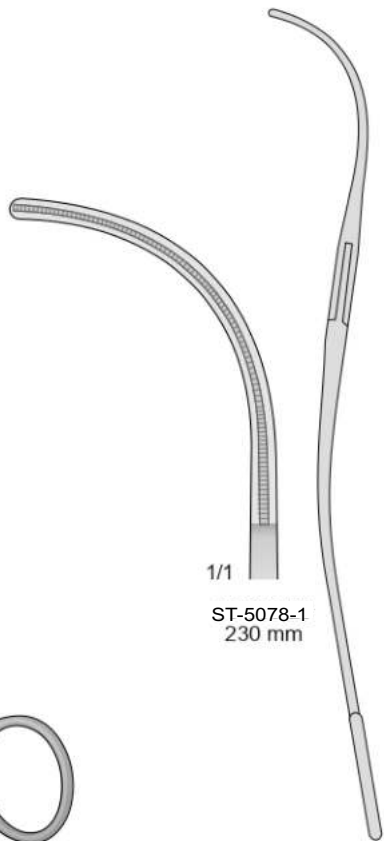


De BAKEY
ST-5075
200 mm

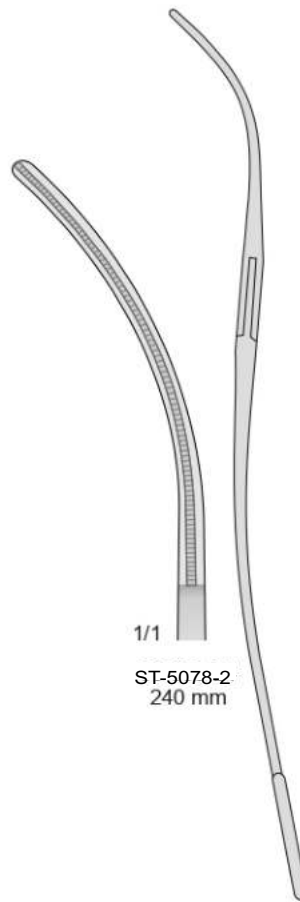
1/1
ST-5075-1



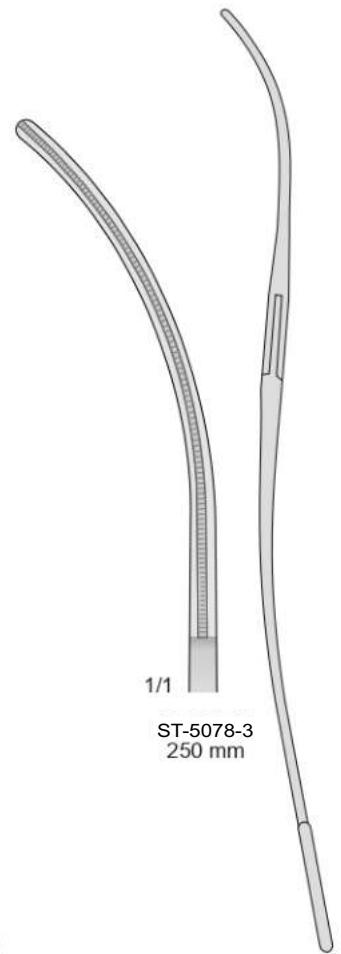
De BAKEY-BAHNSON
ST-5078



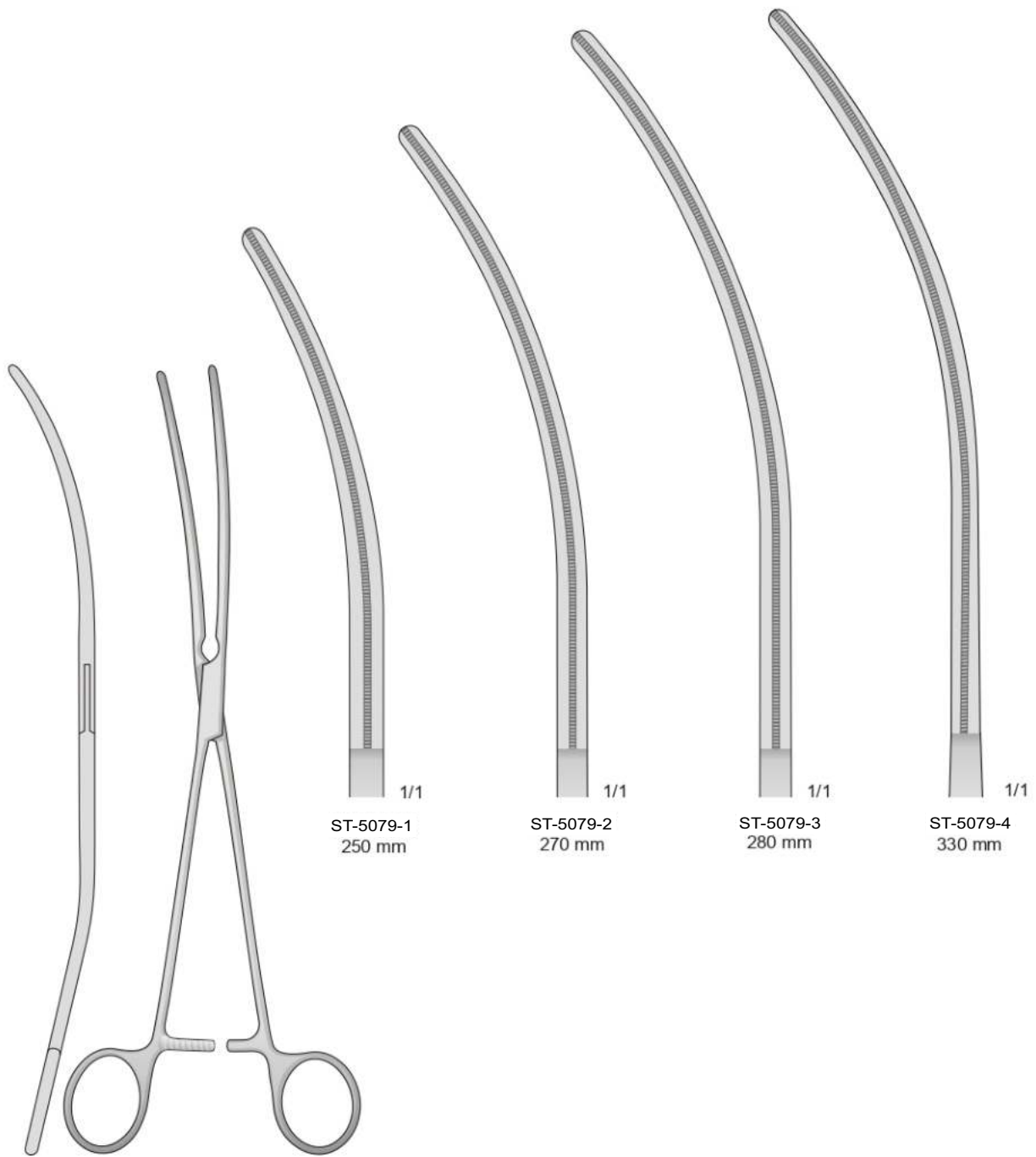
1/1
ST-5078-1
230 mm



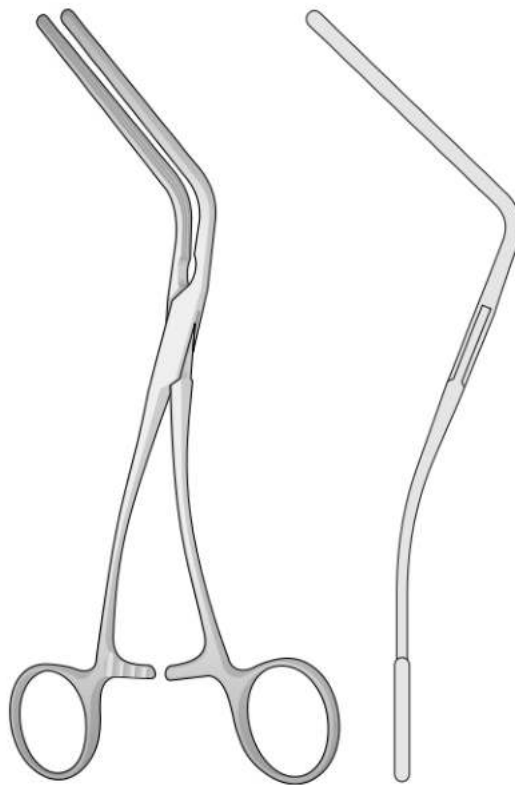
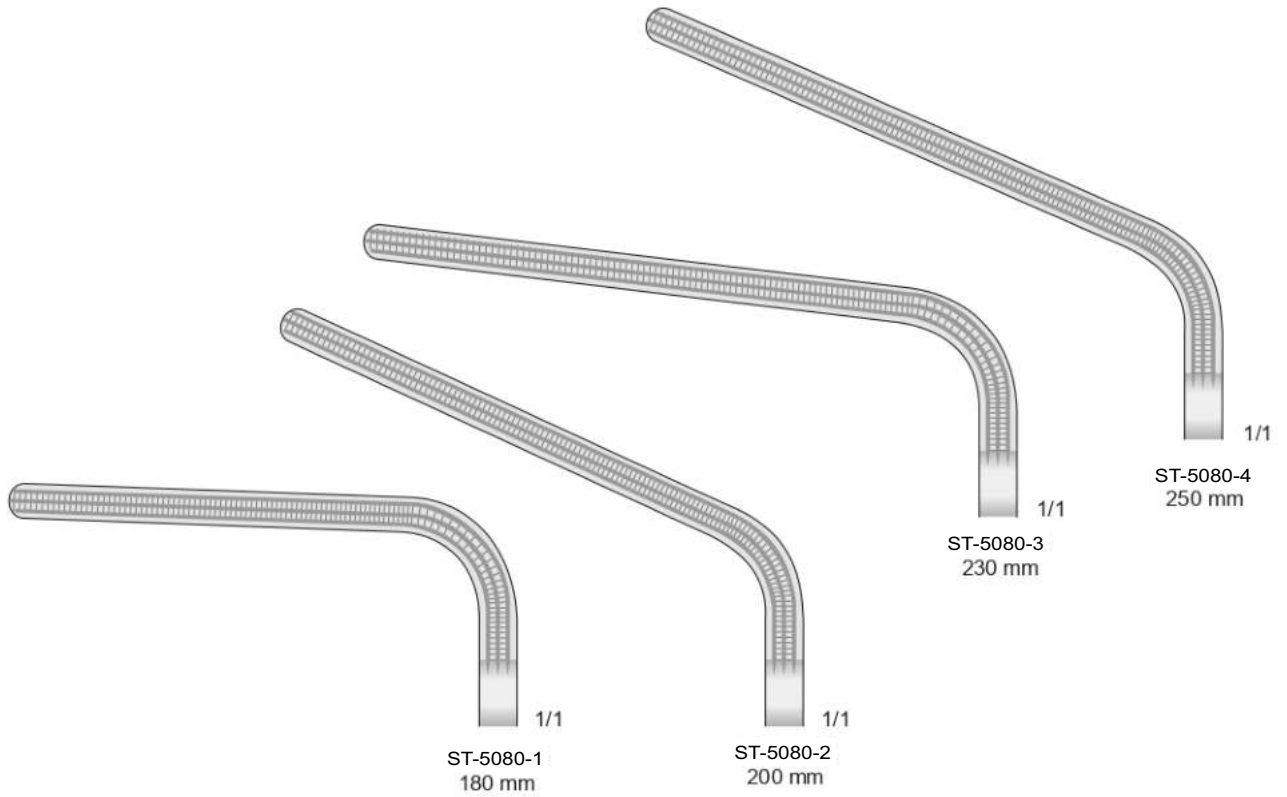
1/1
ST-5078-2
240 mm



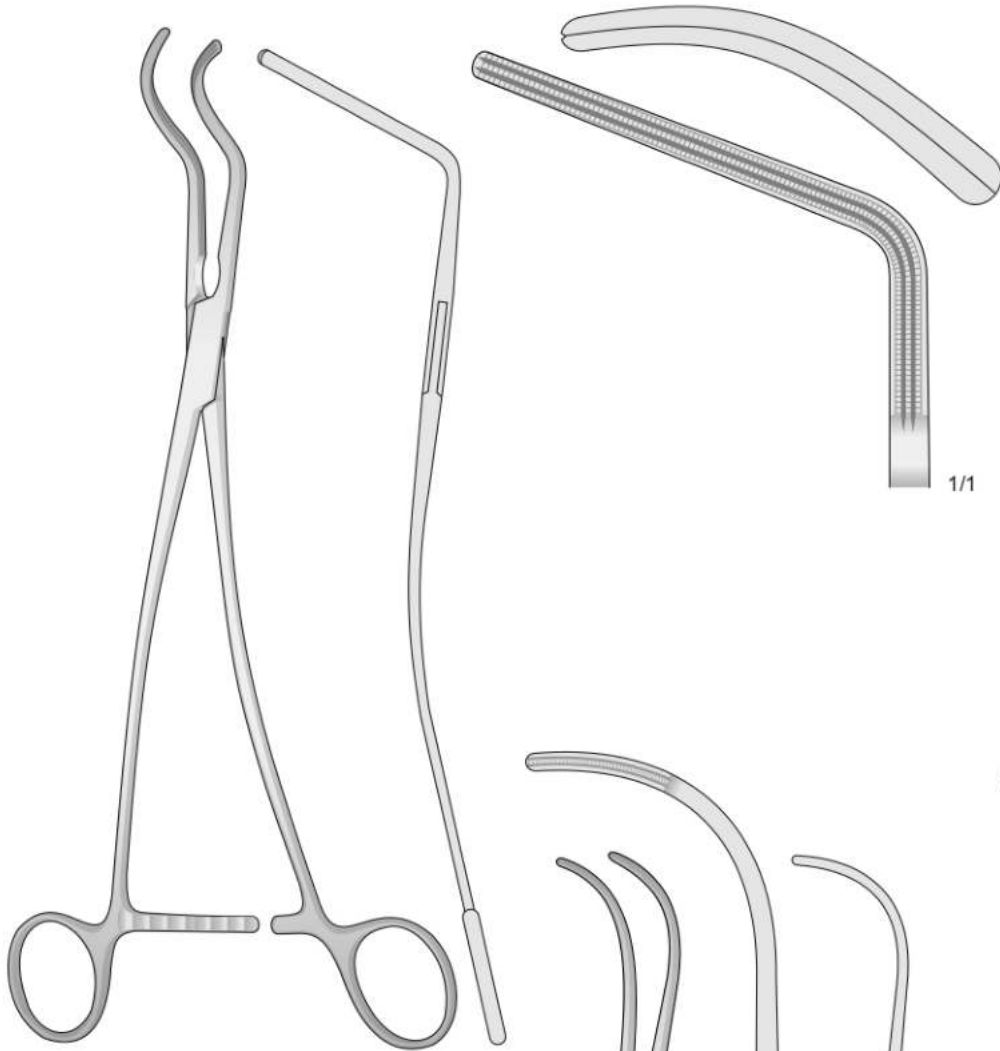
1/1
ST-5078-3
250 mm



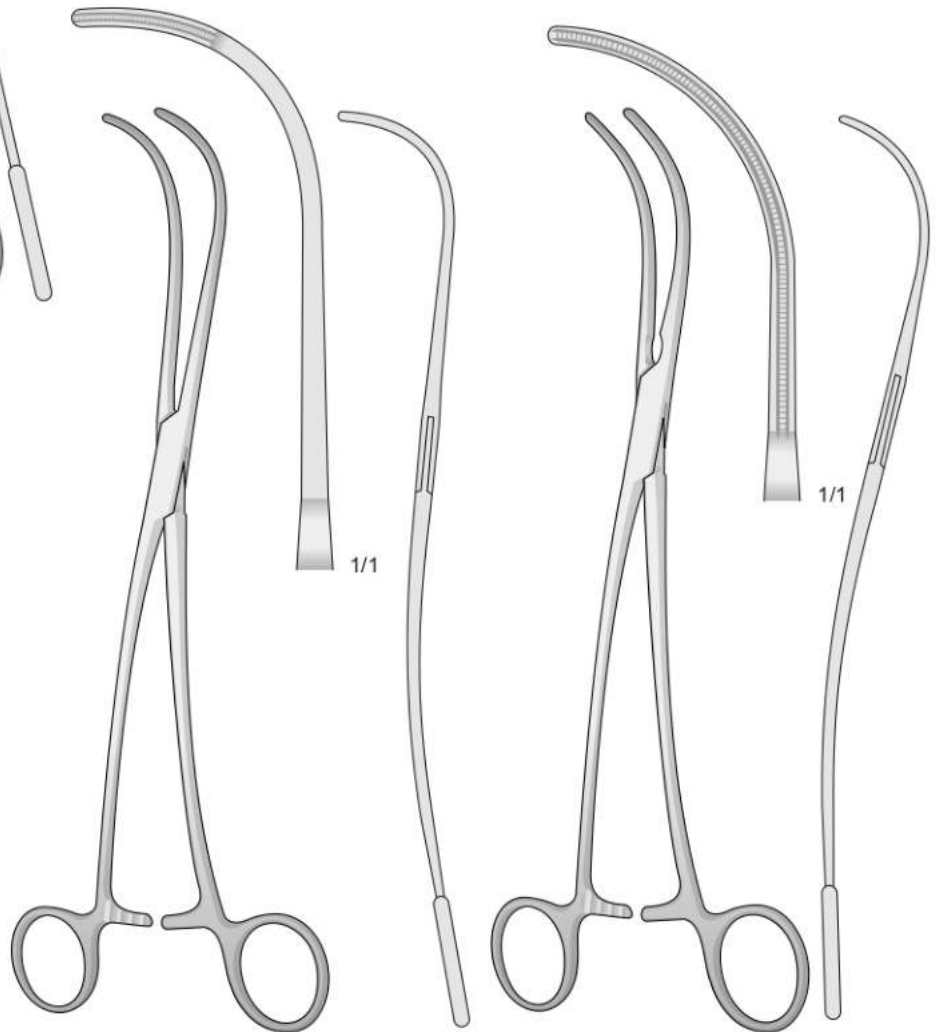
De BAKEY
ST-5079



MORRIS-De BAKEY
ST-5080



De BAKEY
ST-5081
270 mm

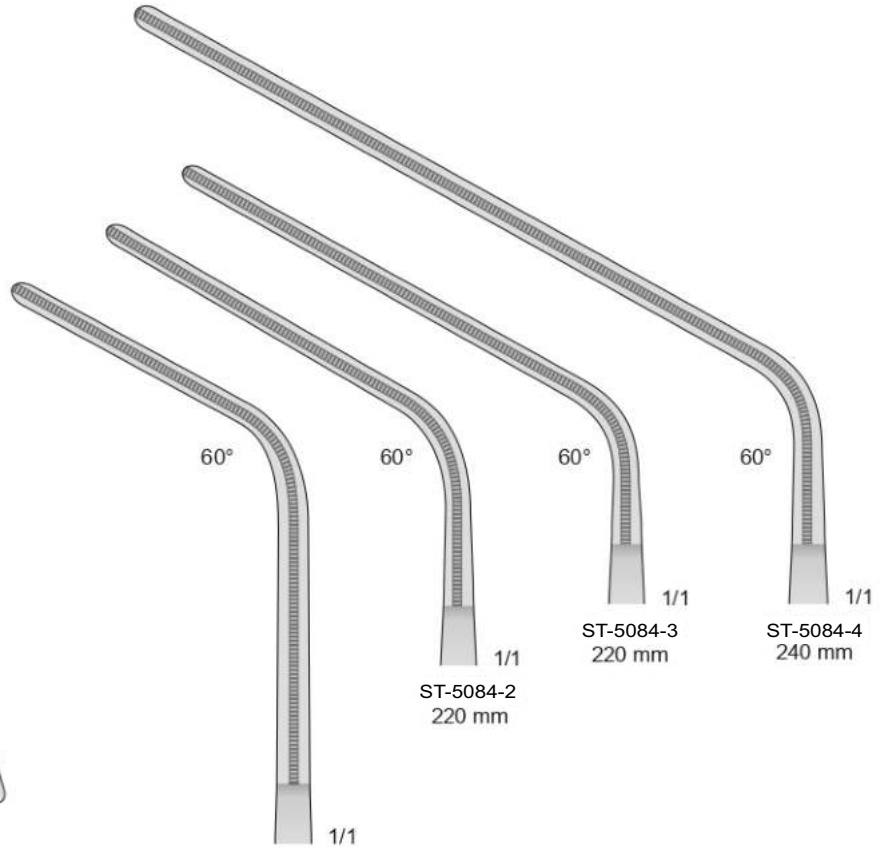


De BAKEY
ST-5082
240 mm

De BAKEY
ST-5083
240 mm



De BAKEY
ST-5084



ST-5084-1
230 mm

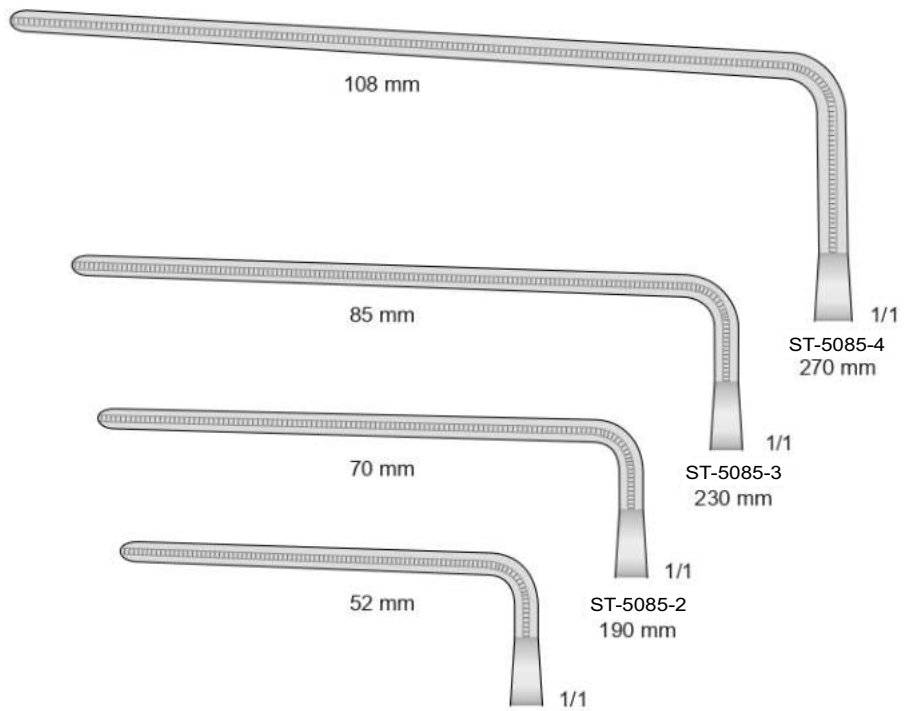
ST-5084-2
220 mm

ST-5084-3
220 mm

ST-5084-4
240 mm



De-BAKEY
ST-5085



ST-5085-1
180 mm

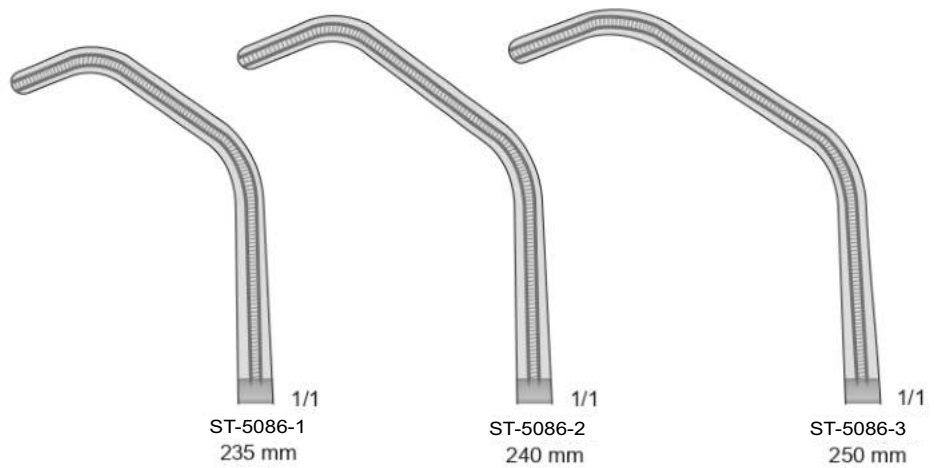
ST-5085-2
190 mm

ST-5085-3
230 mm

ST-5085-4
270 mm



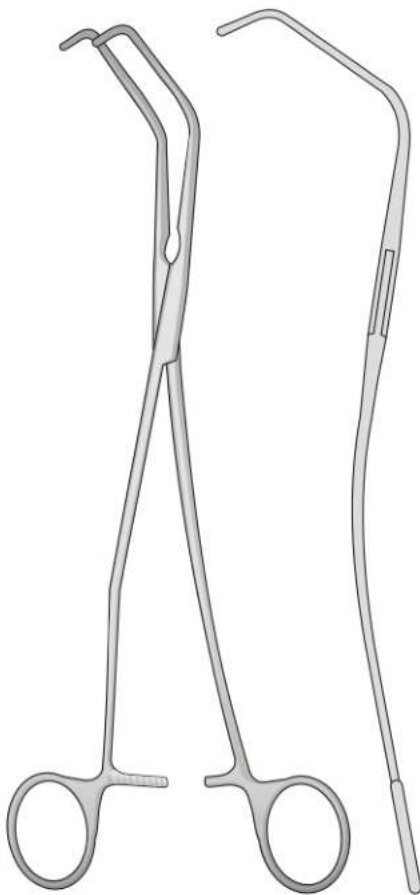
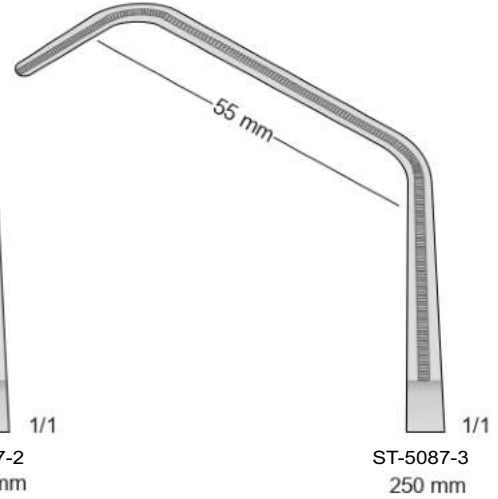
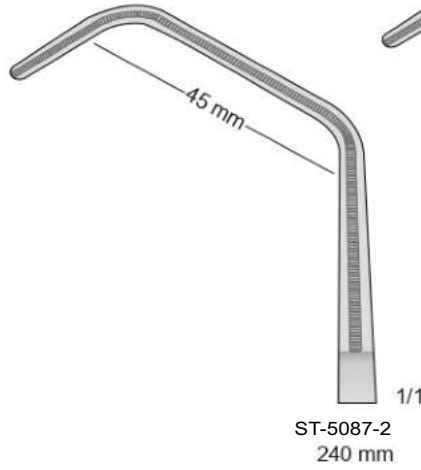
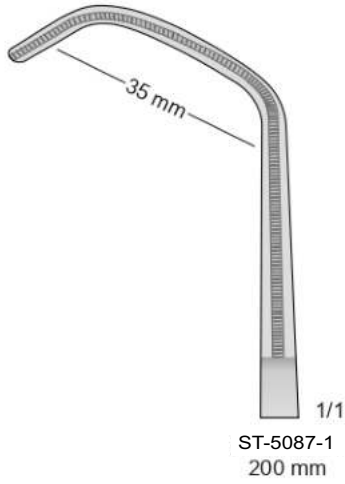
De BAKEY-SATINSKY
ST-5086



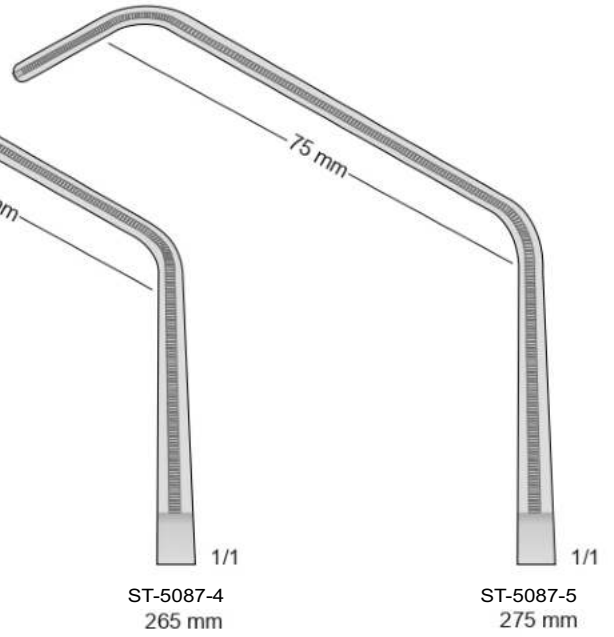
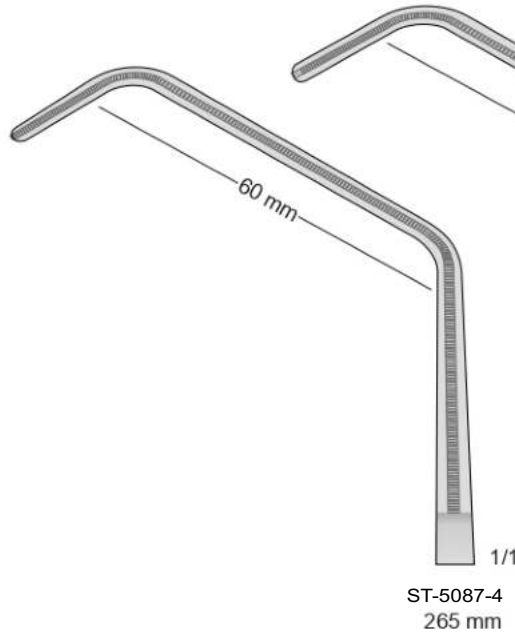
1/1
ST-5086-1
235 mm

1/1
ST-5086-2
240 mm

1/1
ST-5086-3
250 mm

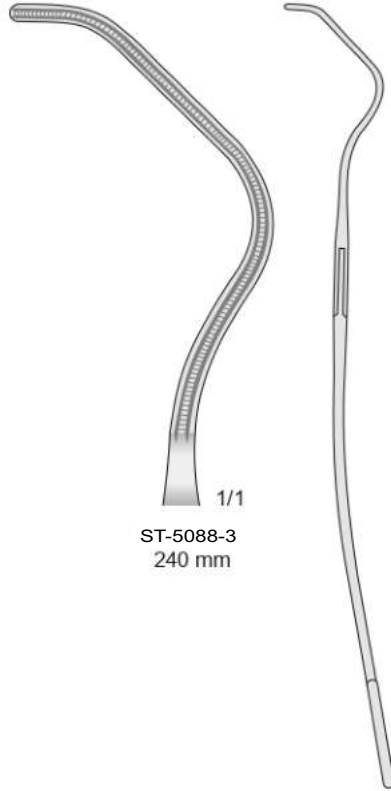


De-BAKEY
ST-5087

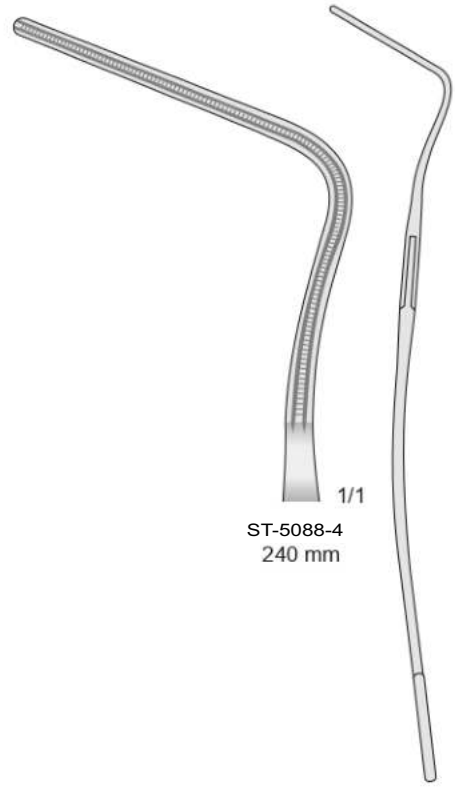




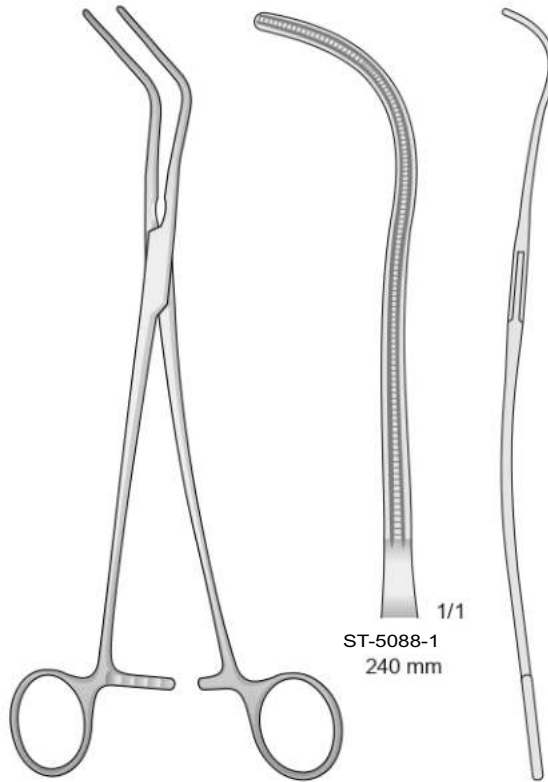
1/1
ST-5088-2
240 mm



1/1
ST-5088-3
240 mm

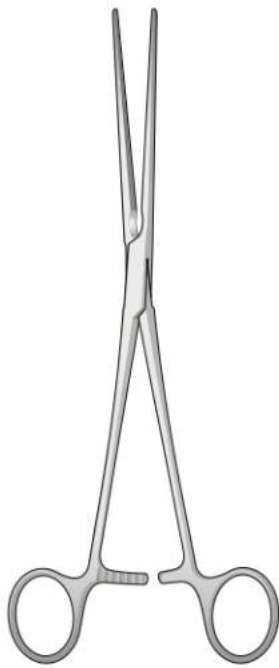


1/1
ST-5088-4
240 mm



1/1
ST-5088-1
240 mm

De BAKEY-HARKEN
ST-5088



De BAKEY
ST-5088



1/1
ST-5088-1
215 mm



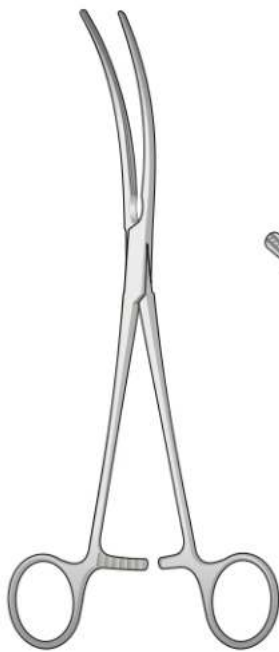
1/1
ST-5088-2
230 mm



1/1
ST-5088-3
270 mm



1/1
ST-5088-4
315 mm



De BAKEY
ST-5089



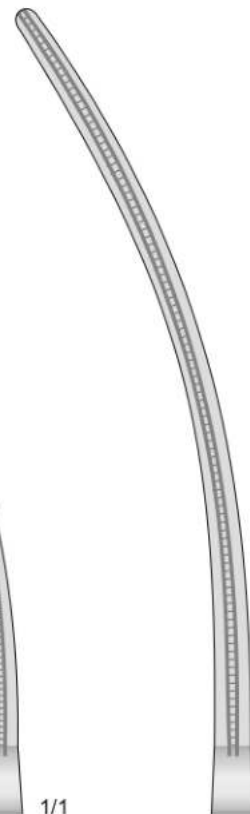
1/1
ST-5089-1
215 mm



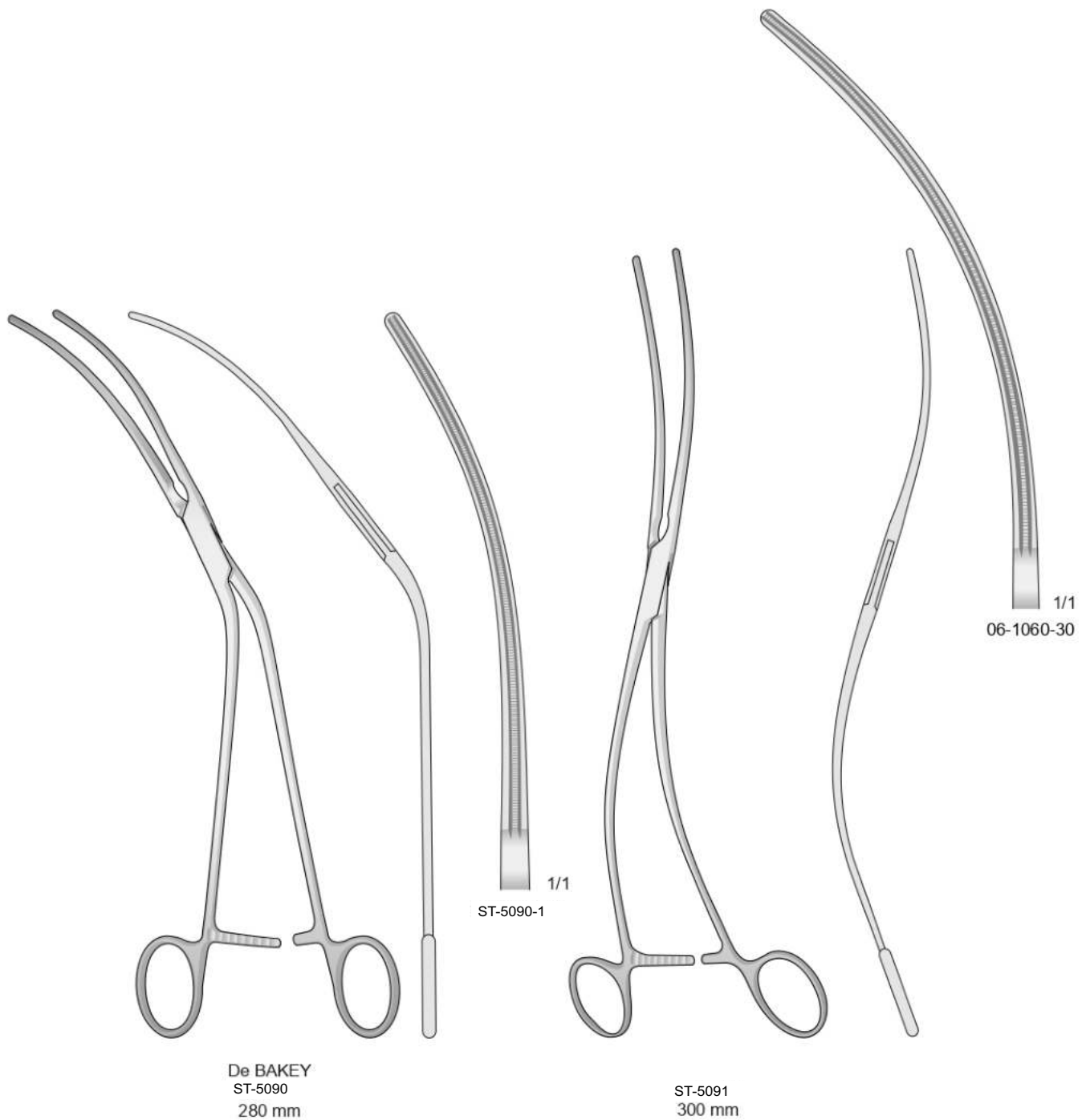
1/1
ST-5089-2
230 mm

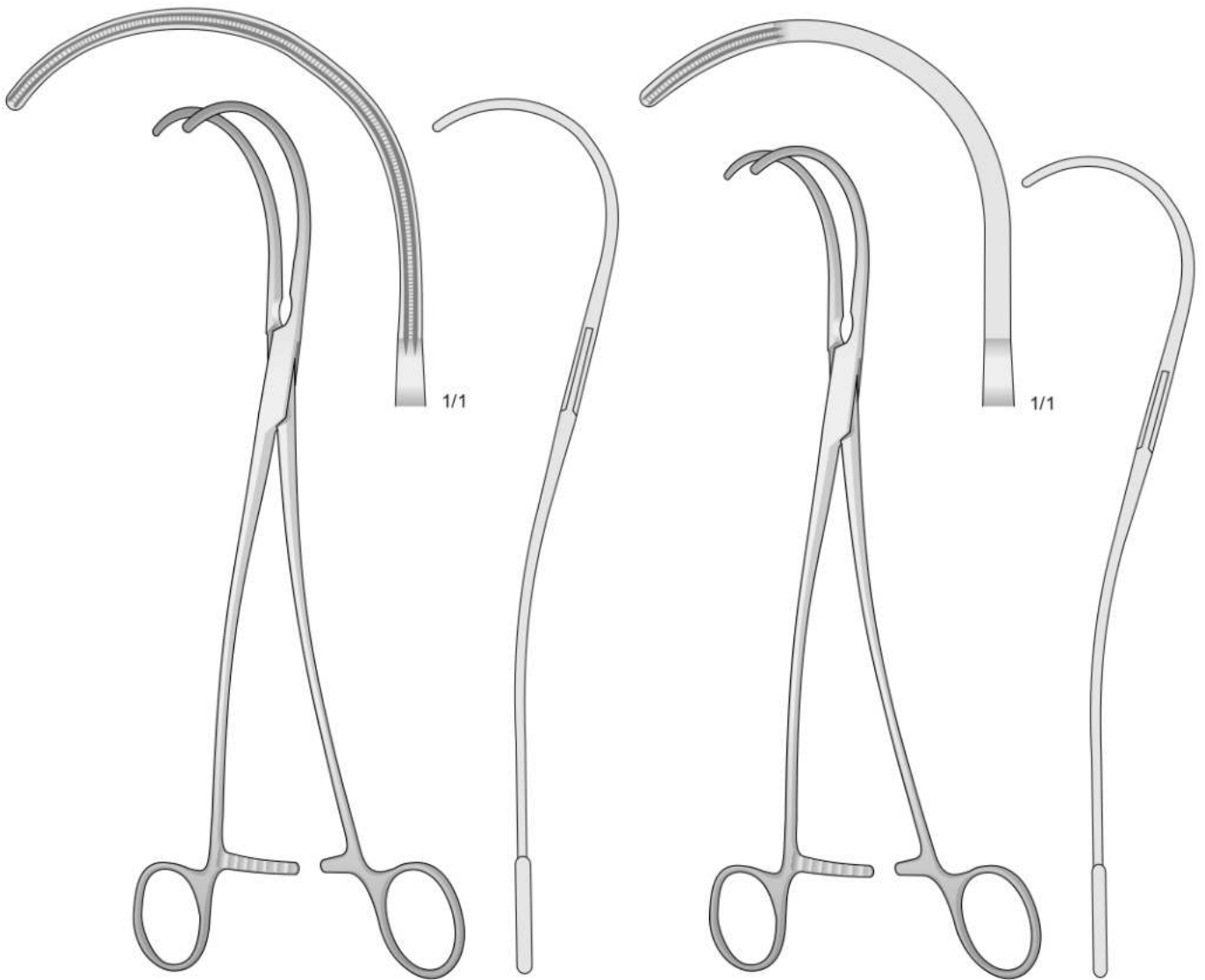


1/1
ST-5089-3
270 mm



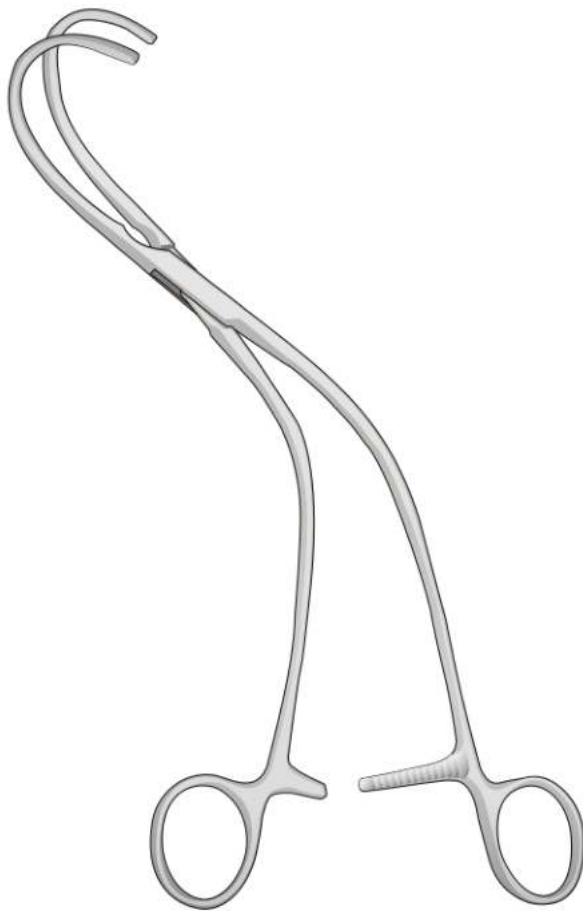
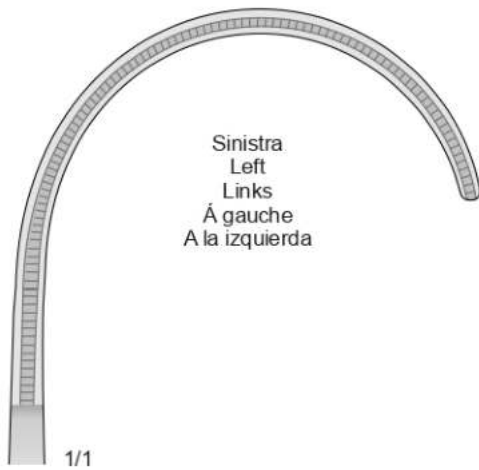
1/1
ST-5089-4
310 mm



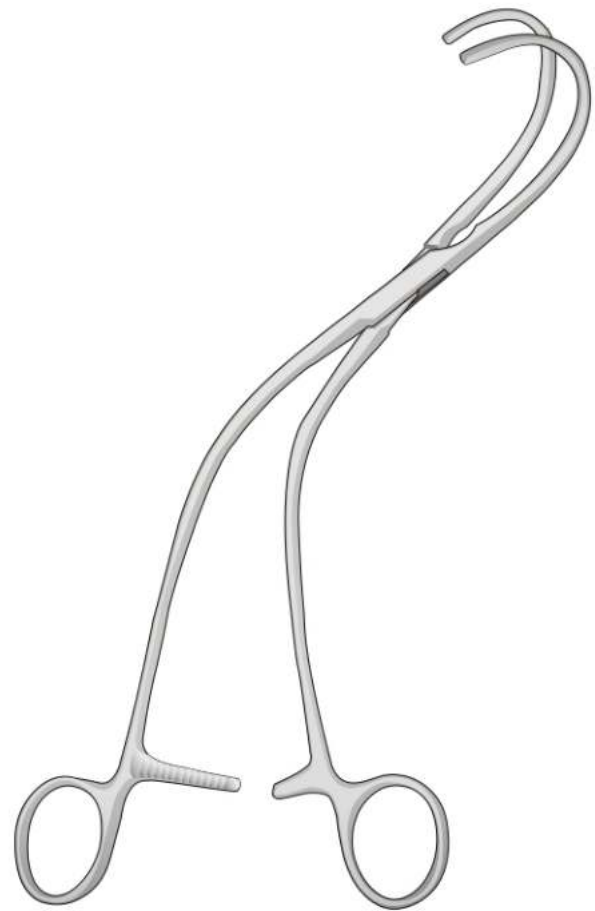


De BAKEY
ST-5092
260 mm

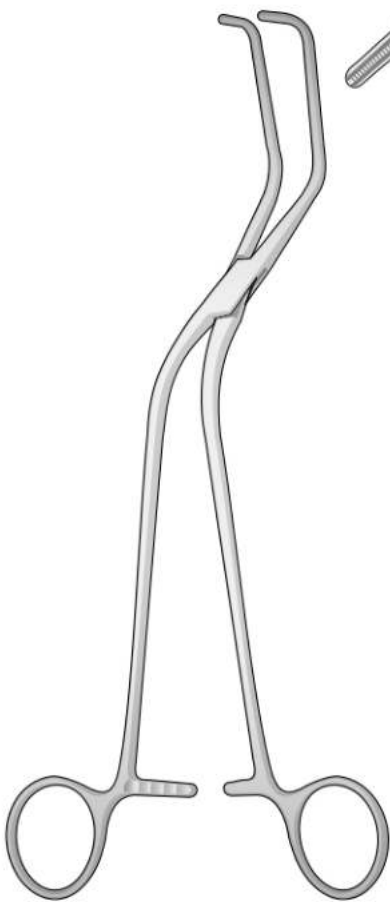
De BAKEY
ST-5093
250 mm



WEBER
ST-5094
260 mm



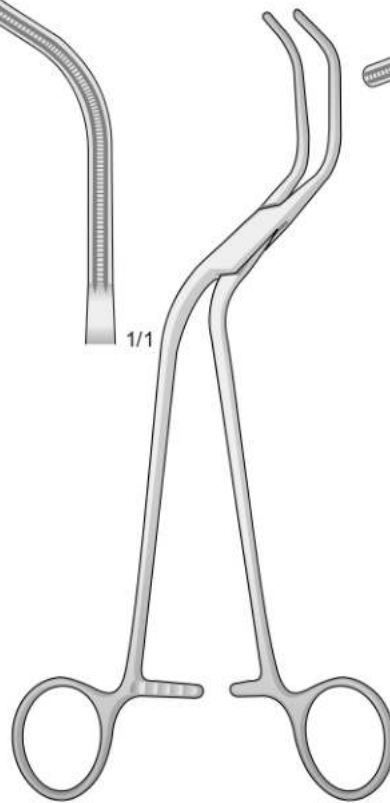
WEBER
ST-5095
260 mm



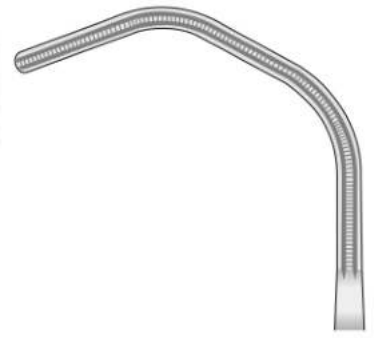
OCHSNER
ST-5096
235 mm



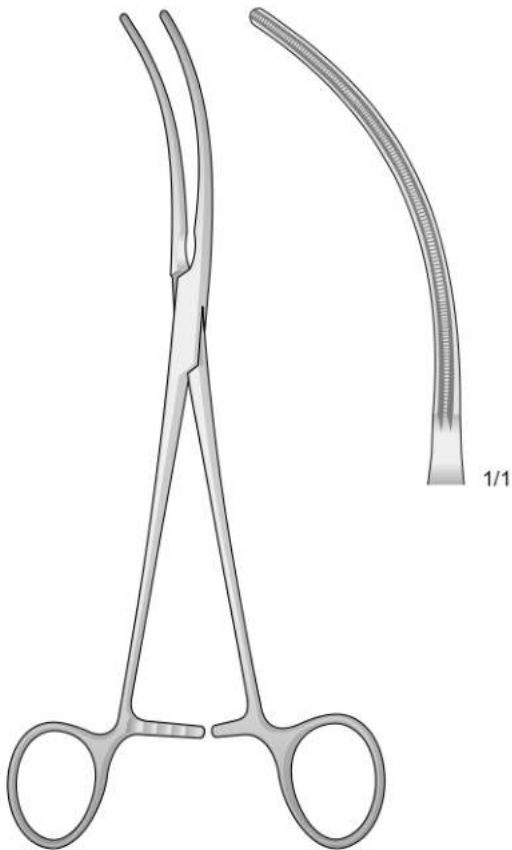
1/1



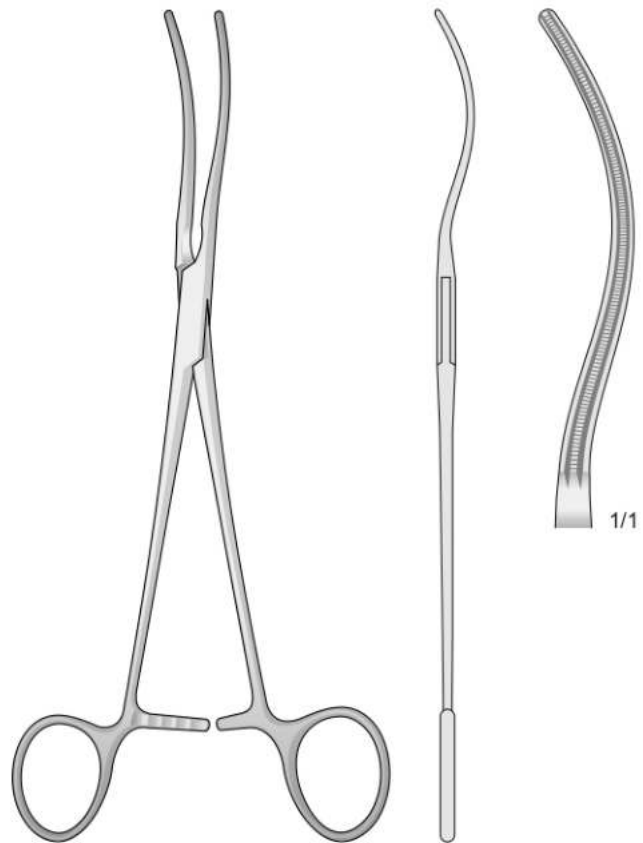
DIETRICH
ST-5097
210 mm



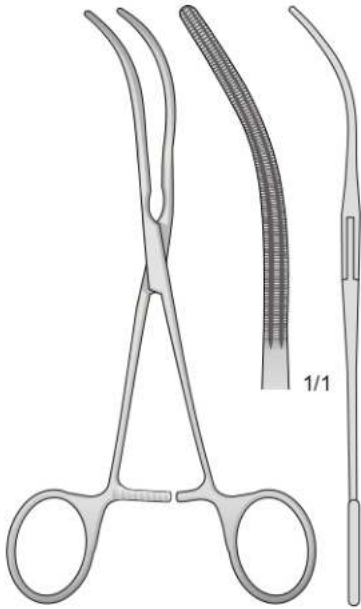
1/1



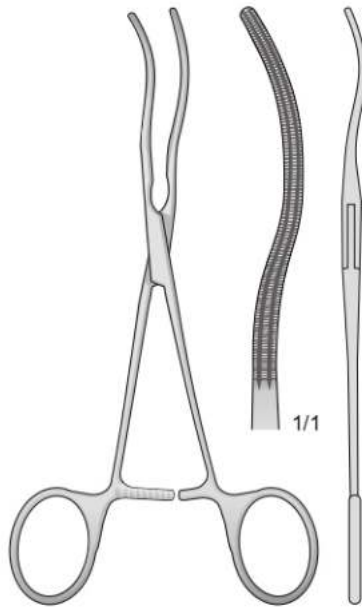
POTTS
ST-5097
220 mm



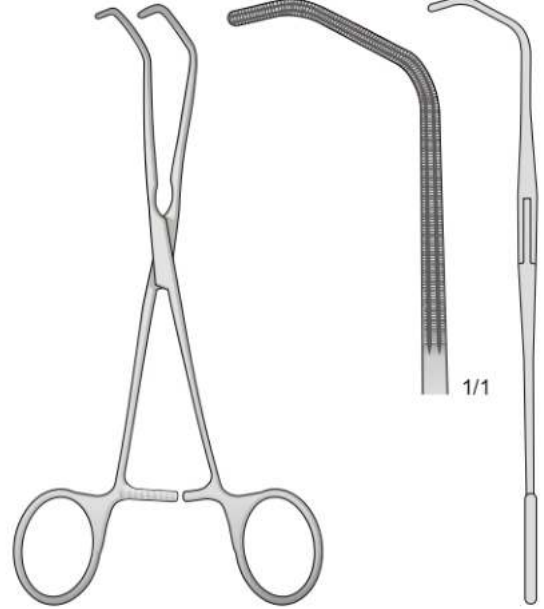
POTTS
ST-5098
220 mm



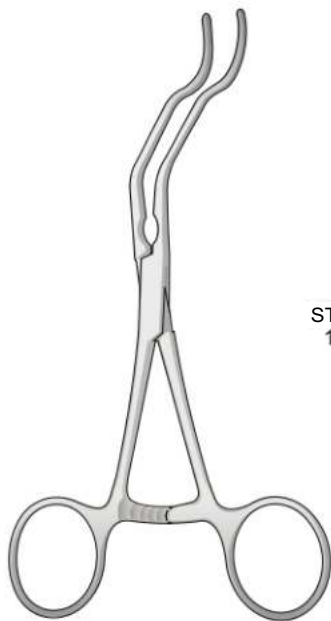
GLOVER
06-1140-17
170 mm



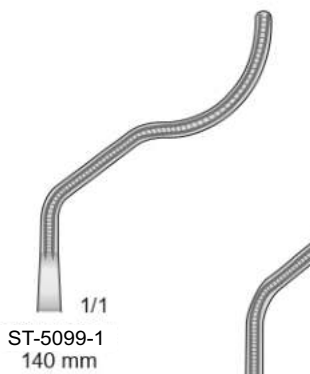
06-1150-17
170 mm



BECK
06-1160-17
170 mm



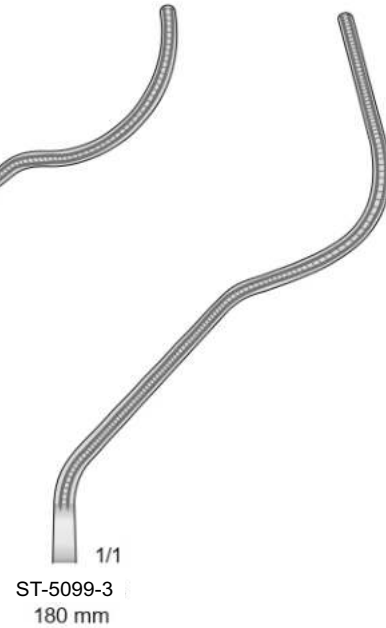
GREGORY
ST-5099



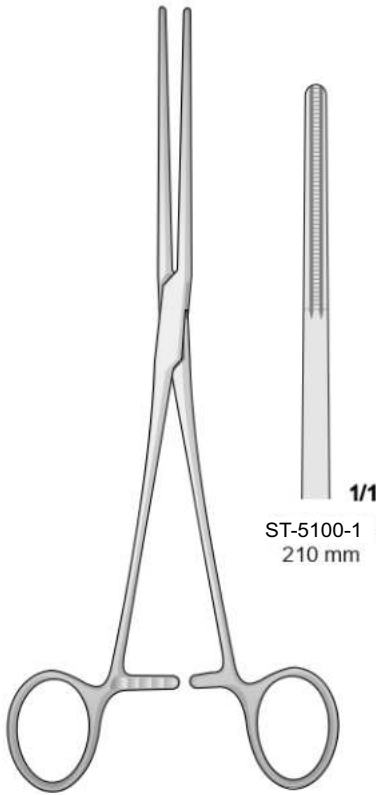
ST-5099-1
140 mm



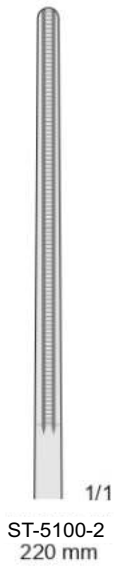
ST-5099-2
160 mm



ST-5099-3
180 mm



POTTS
ST-5100

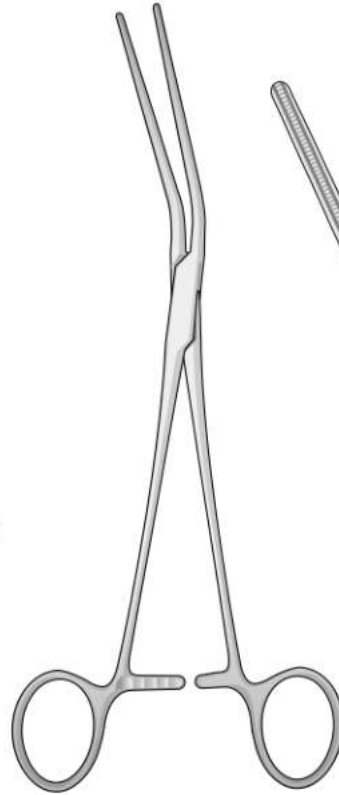


ST-5100-2
220 mm

ST-5100-1
210 mm

1/1

1/1



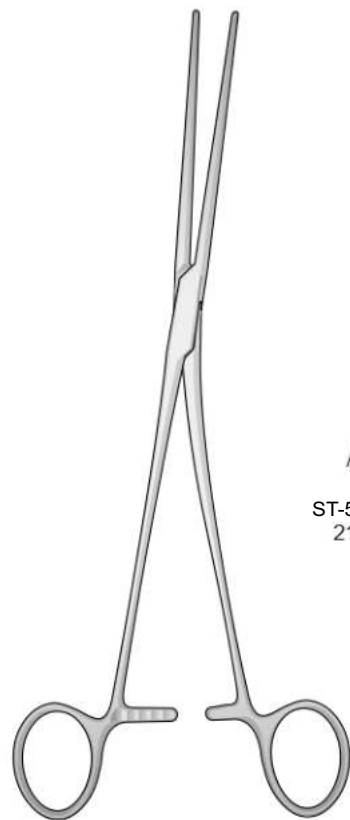
POTTS
ST-5101

ST-5101-1
210 mm

ST-5101-2
220 mm

1/1

1/1



POTTS
ST-5102

ST-5102-1
210 mm

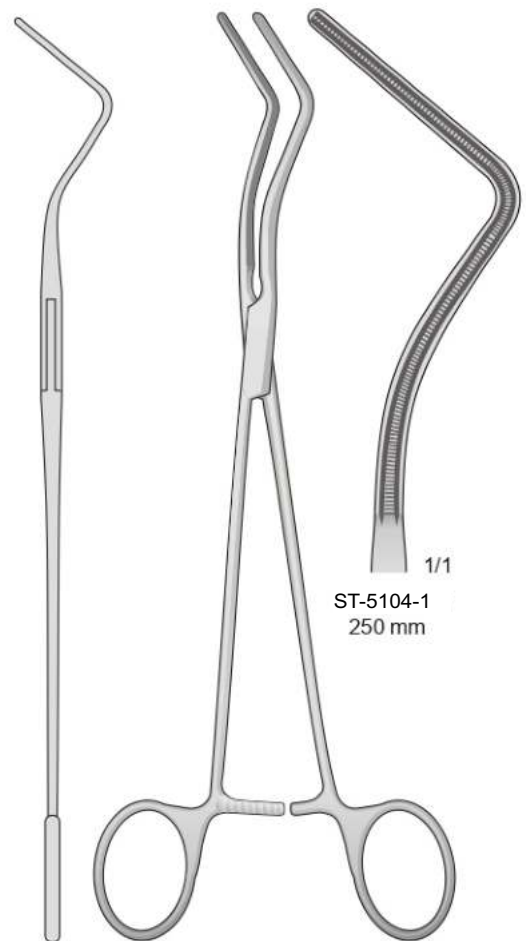
ST-5102-2
220 mm

1/1

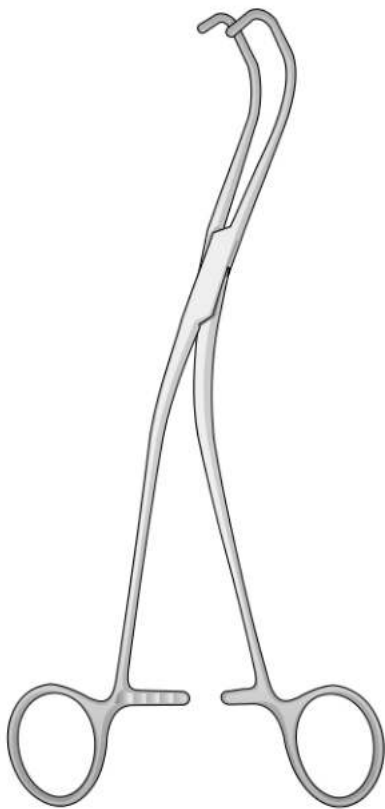
1/1



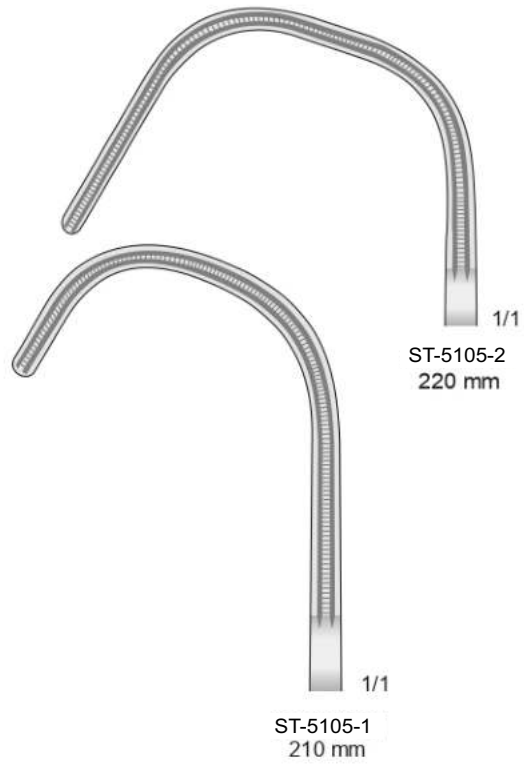
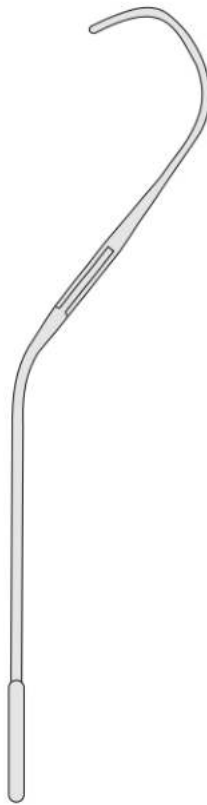
LEES
ST-5103



LEES
ST-5104
250 mm

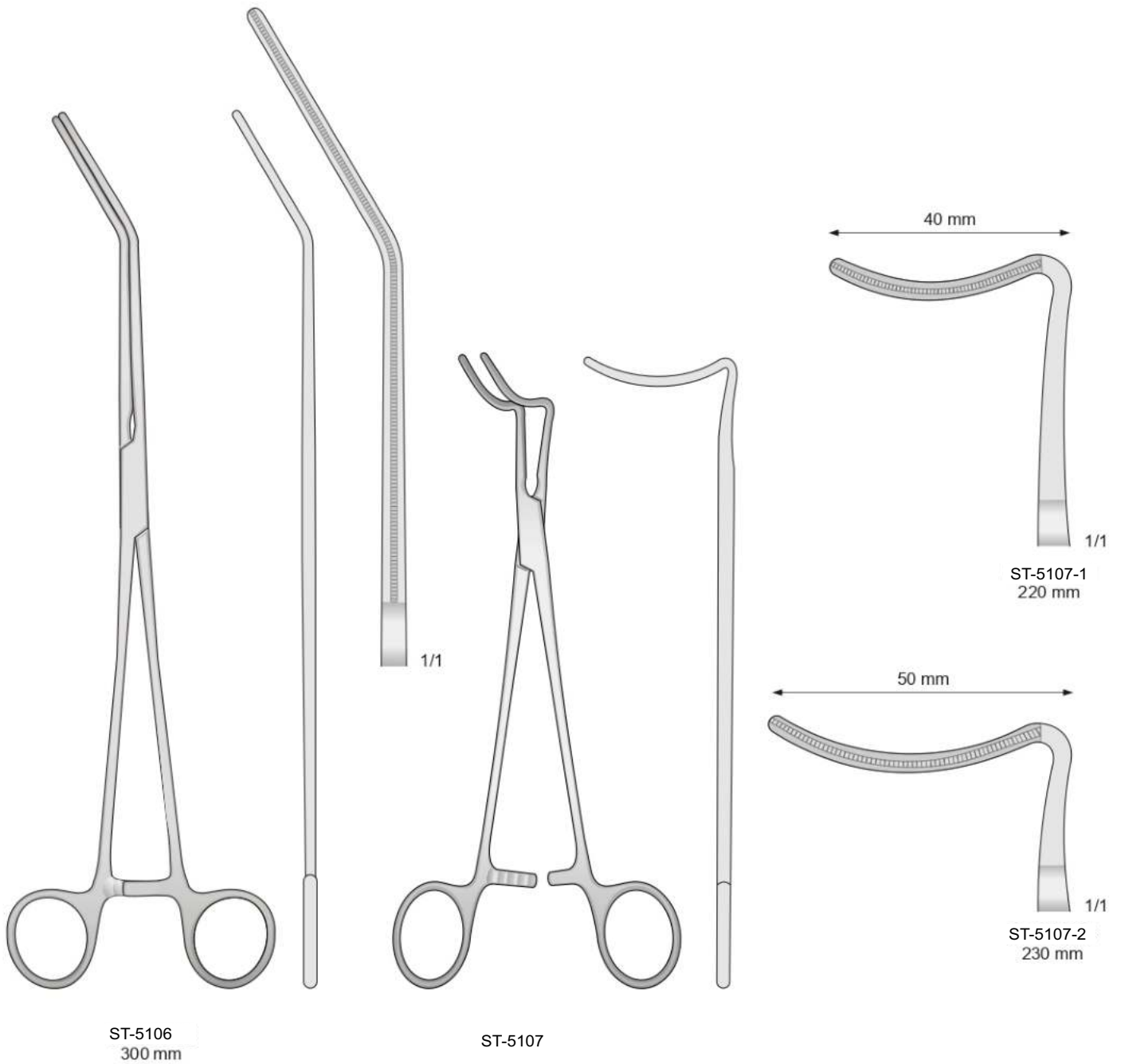


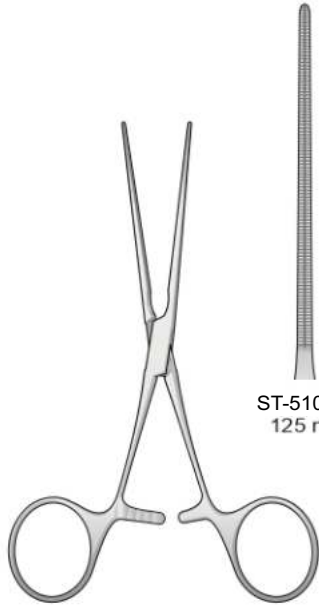
LAMBERT-KAY
ST-5105



ST-5105-1
210 mm

ST-5105-2
220 mm



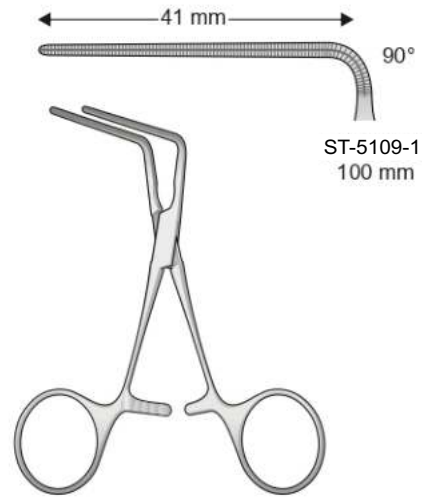


ST-5108-1
125 mm

COOLEY
ST-5108

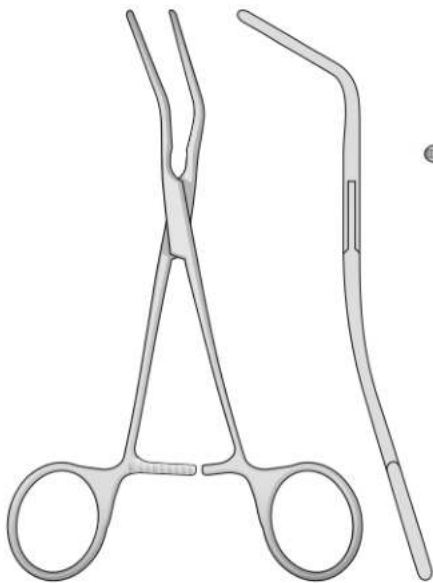


ST-5108-2
115 mm

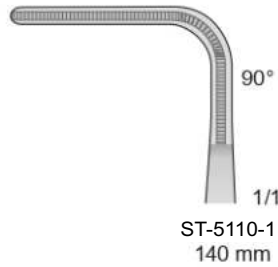


ST-5109-1
100 mm

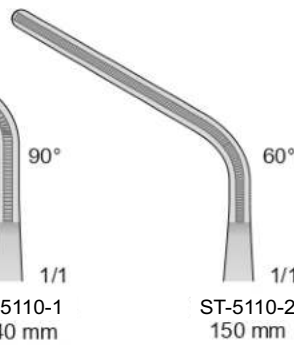
COOLEY
ST-5109



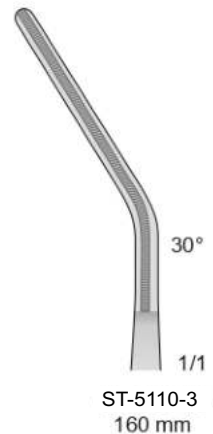
COOLEY
ST-5110



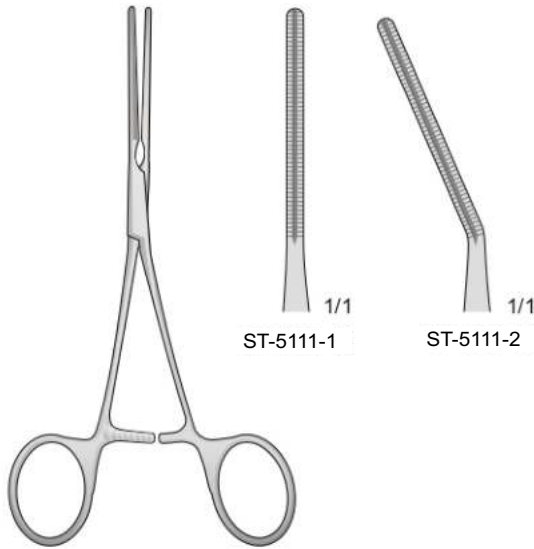
ST-5110-1
140 mm



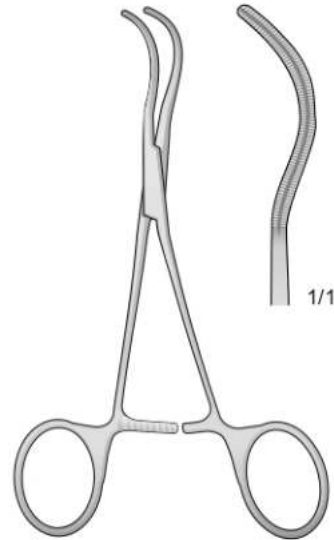
ST-5110-2
150 mm



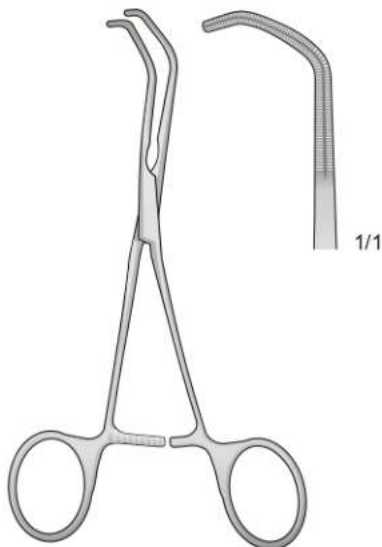
ST-5110-3
160 mm



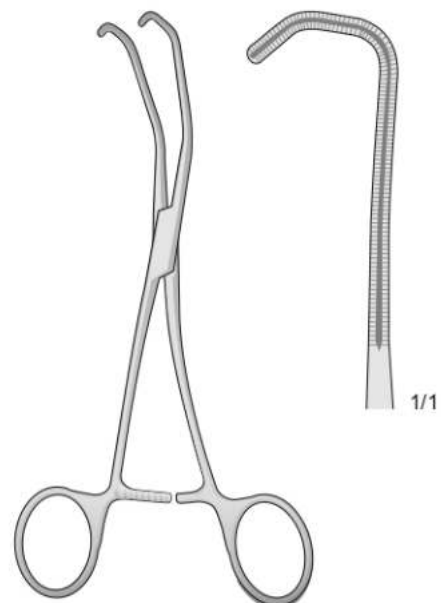
COOLEY
ST-5111
140 mm



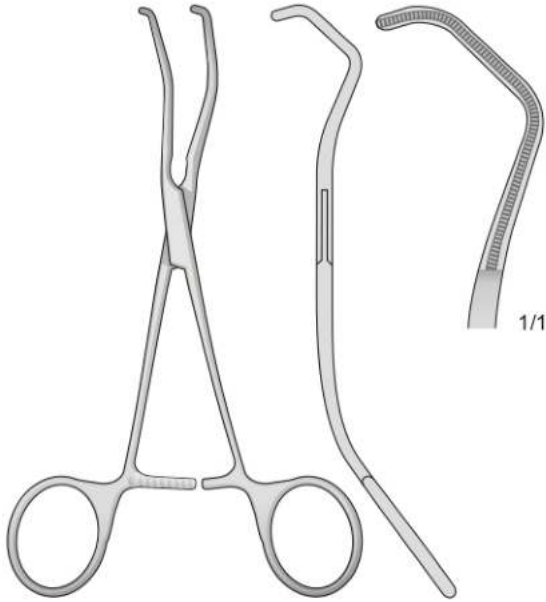
COOLEY
ST-5112
140 mm



COOLEY
ST-5113
140 mm



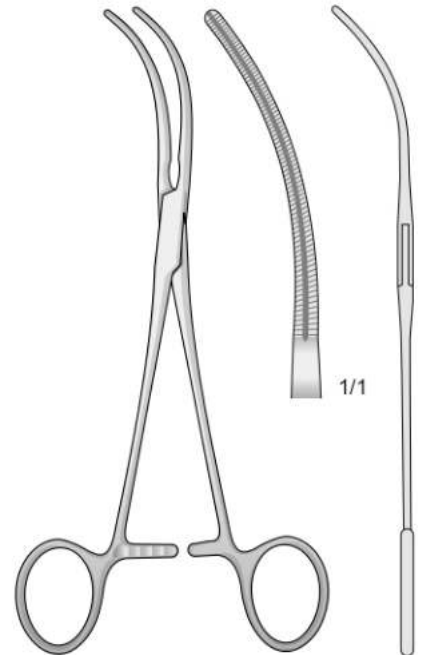
COOLEY
ST-5114
160 mm



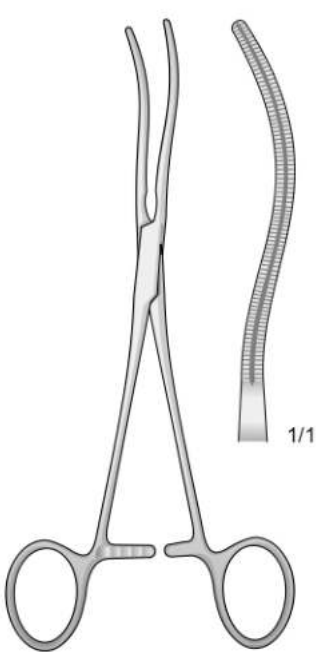
COOLEY
ST-5115
160 mm



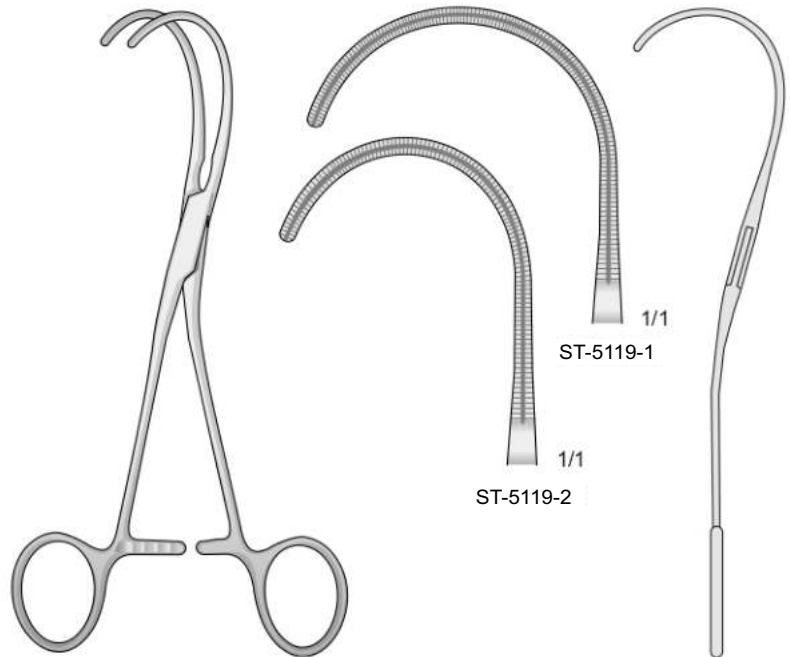
COOLEY
ST-5116
170 mm



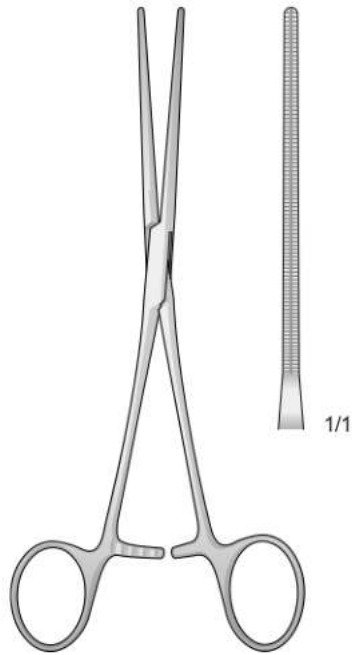
COOLEY
ST-5117
170 mm



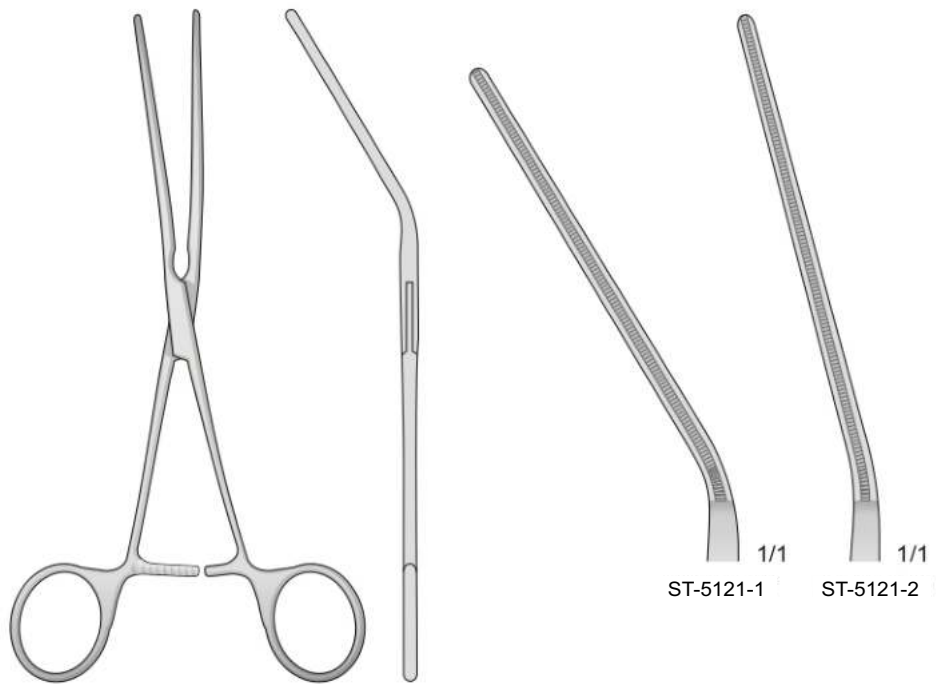
COOLEY
ST-5118
170 mm



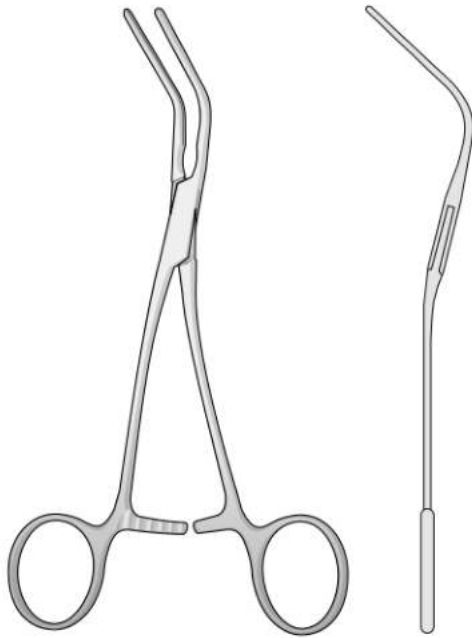
COOLEY
ST-5119
170 mm



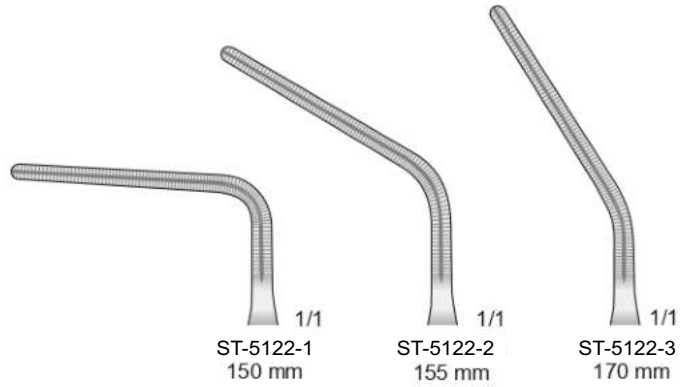
COOLEY
ST-5120
170 mm



LELAND - JONES
ST-5121
190 mm



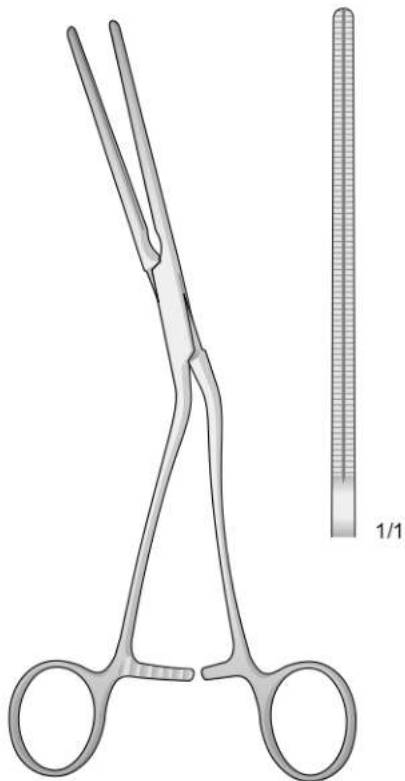
COOLEY
ST-5122



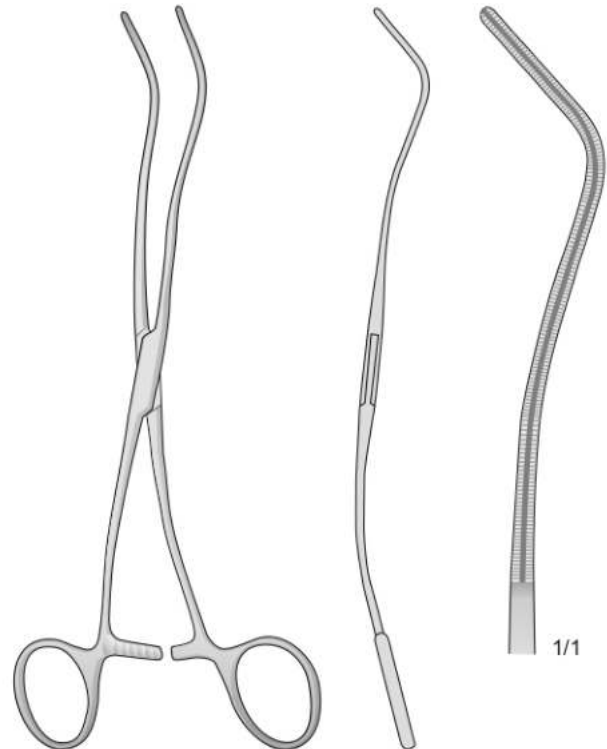
ST-5122-1
150 mm

ST-5122-2
155 mm

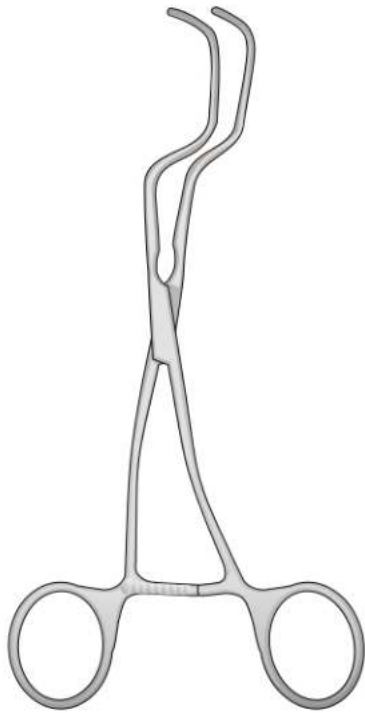
ST-5122-3
170 mm



COOLEY
ST-5123
210 mm



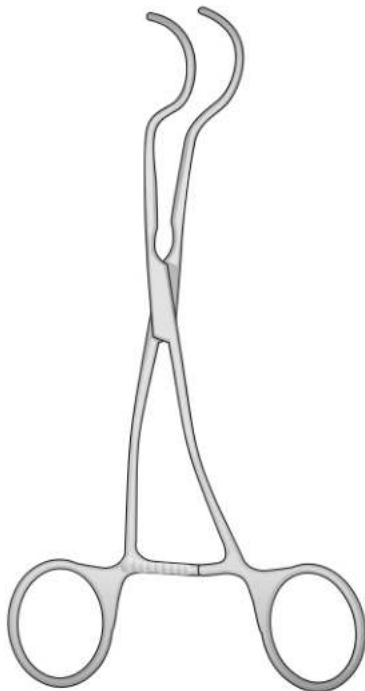
COOLEY
ST-5124
200 mm



DALE
ST-5125
185 mm



1/1
ST-5125-1
185 mm



DALE
ST-5126



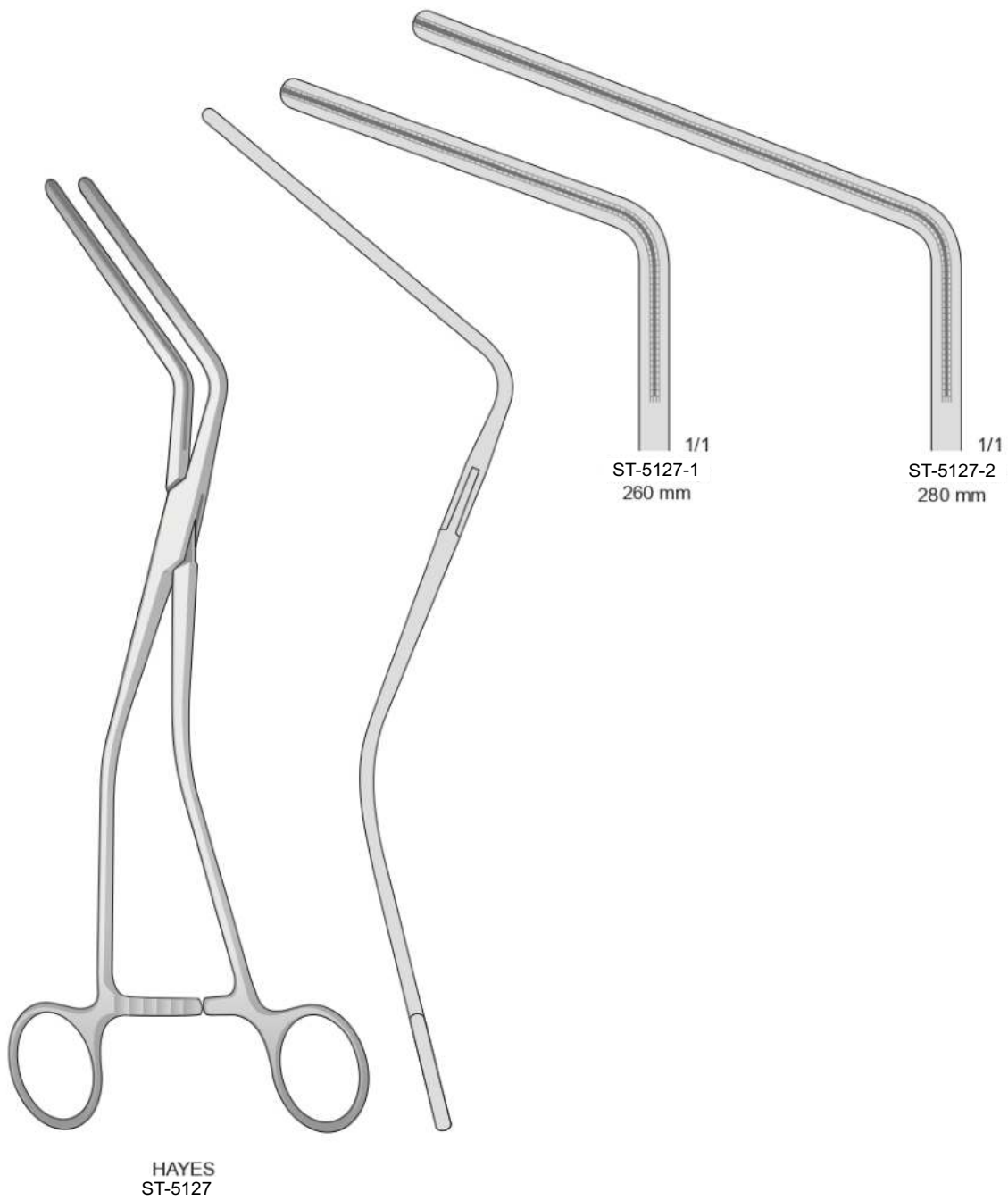
1/1
ST-5126-1
170 mm



1/1
ST-5126-2
175 mm

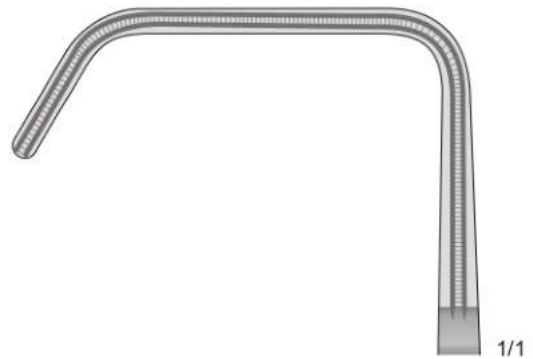


1/1
ST-5126-3
185 mm





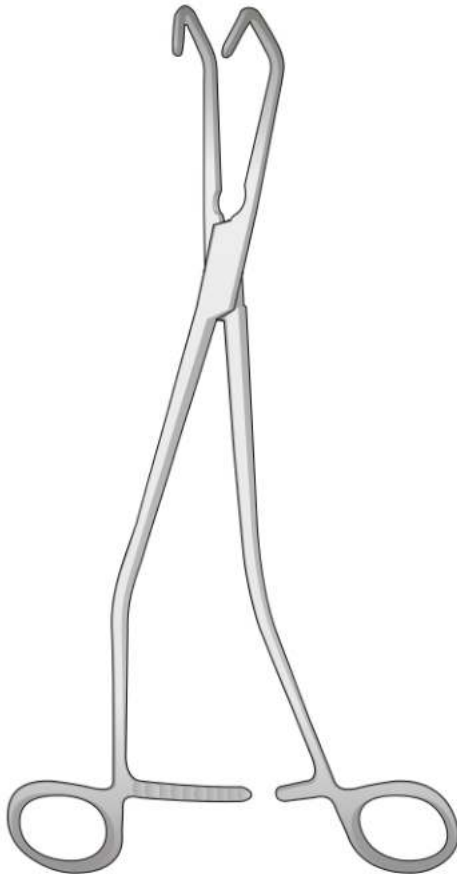
ST-5128-1
40 mm



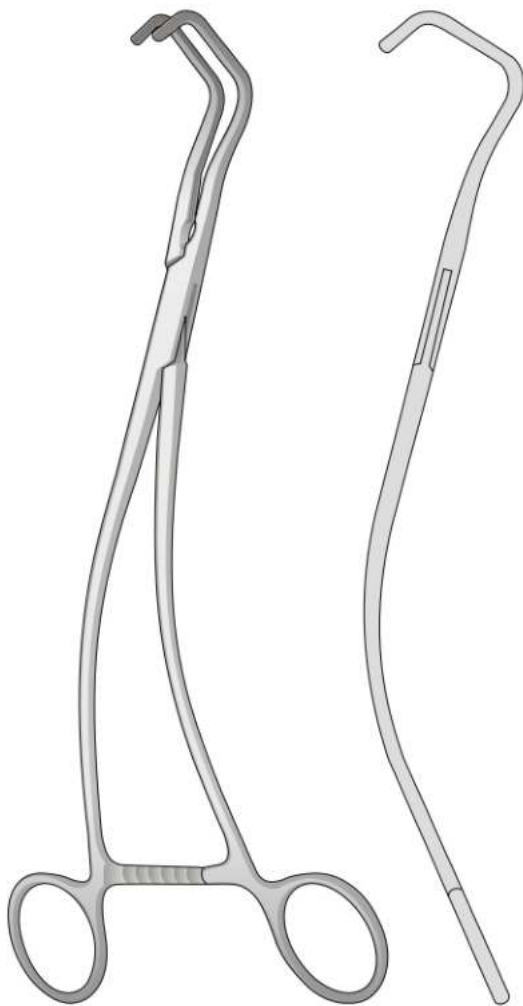
ST-5128-2
50 mm



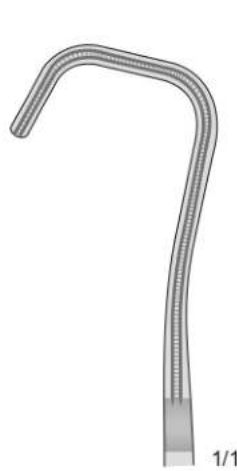
ST-5128-3
60 mm



HOPT
ST-5128-1 - 230 mm
ST-5128-2 - 235 mm
ST-5128-3 - 240 mm



URO-TANGENTIAL
ST-5129
260 mm

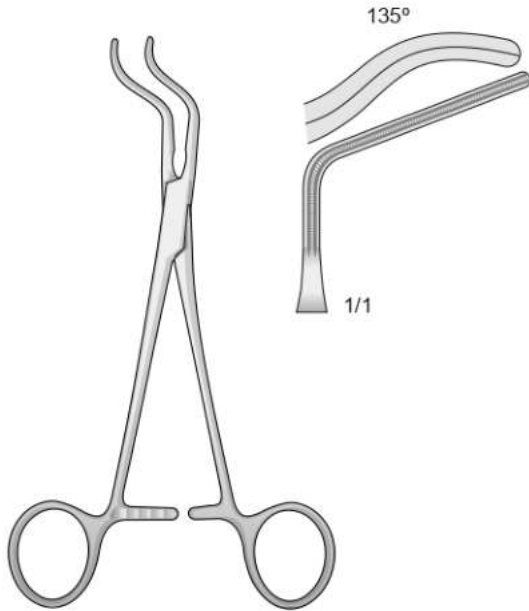


ST-5129-1
260 mm

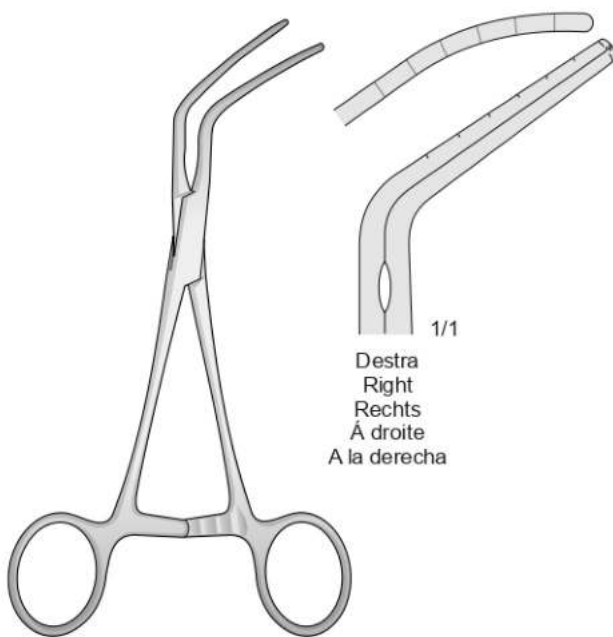


ST-5129-2
260 mm

Per bambini
For children
Kinderklemmen
Pour enfants
Para niños

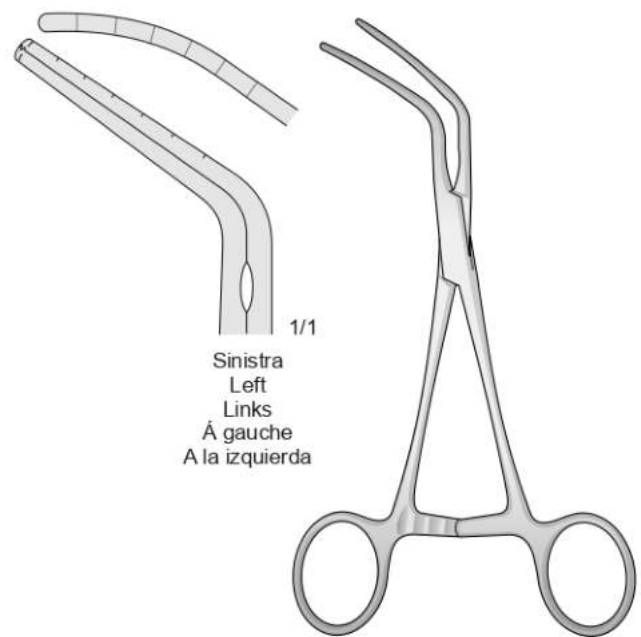


SUBRAMANIAN-MINIATURE
06-1500-15
155 mm



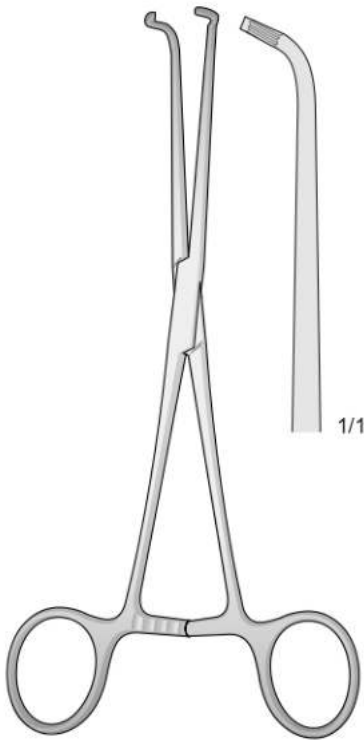
Destra
Right
Rechts
À droite
A la derecha

SUBRAMANIAN
06-1510-16
160 mm

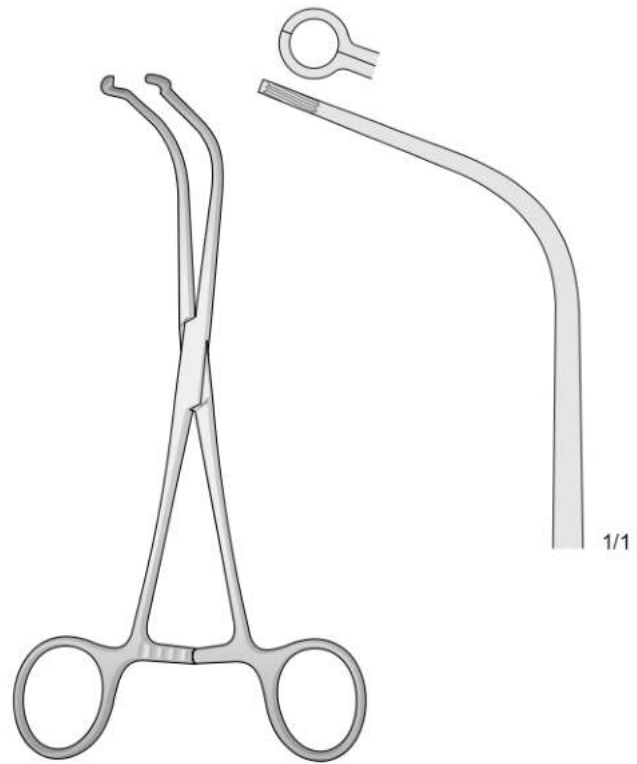


Sinistra
Left
Links
À gauche
A la izquierda

SUBRAMANIAN
06-1520-16
160 mm



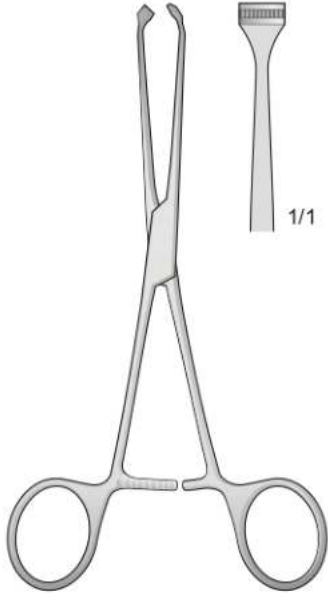
JAVID
06-1530-18
180 mm



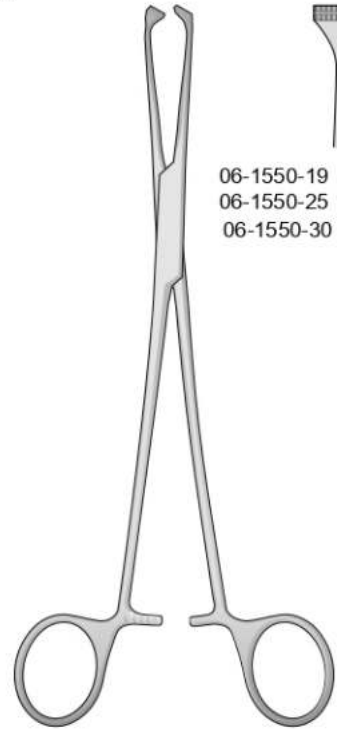
JAVID
06-1530-19
190 mm



Atraumatiche - Atraumatic - Atraumatische
Atraumatique - Atraumáticas

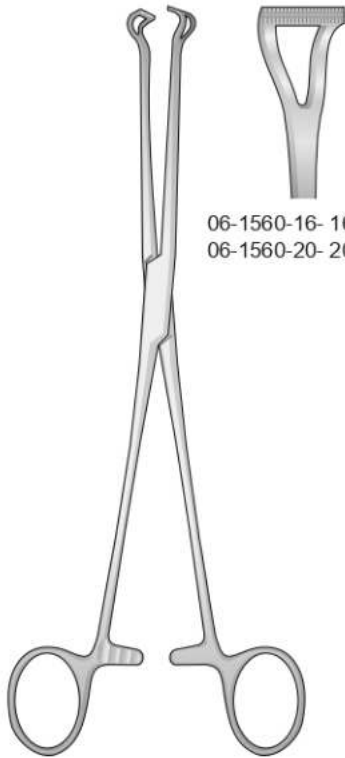


ALLIS
06-1540-15
150 mm



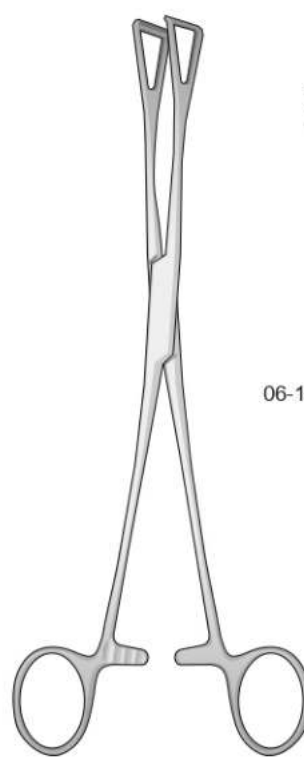
06-1550-19 - 190 mm
06-1550-25 - 250 mm
06-1550-30 - 300 mm

ALLIS
06-1550



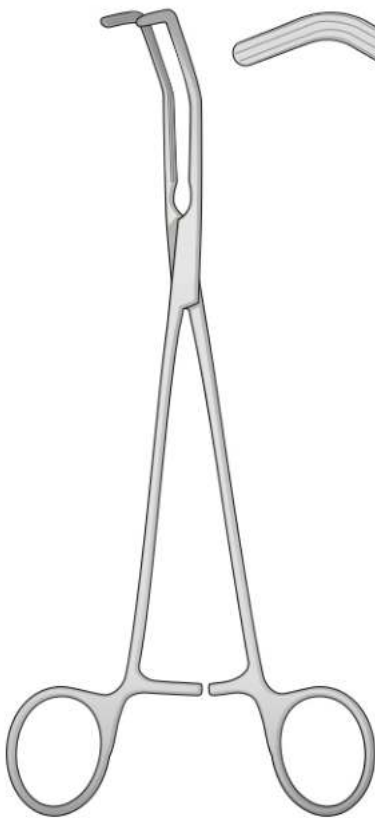
06-1560-16- 160 mm
06-1560-20- 200 mm

BABCOCK
06-1560

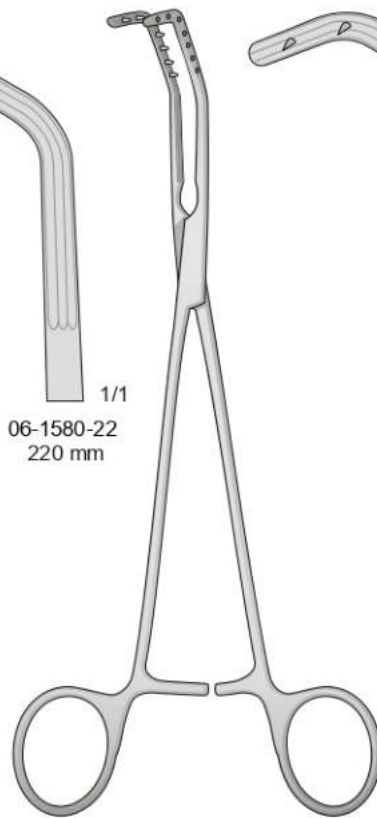


14 mm
18 mm
06-1570-01- 200 mm
06-1570-02- 200 mm

DUVAL
06-1570



PRICE - THOMAS
06-1580
220 mm

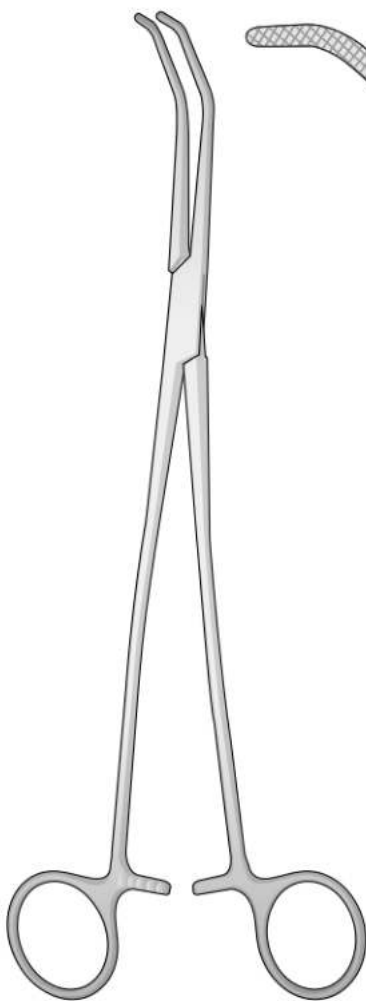


PRICE - THOMAS
06-1590

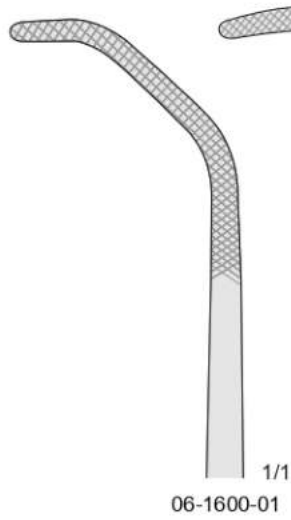
1/1
06-1580-22
220 mm

1/1
06-1590-01
220 mm

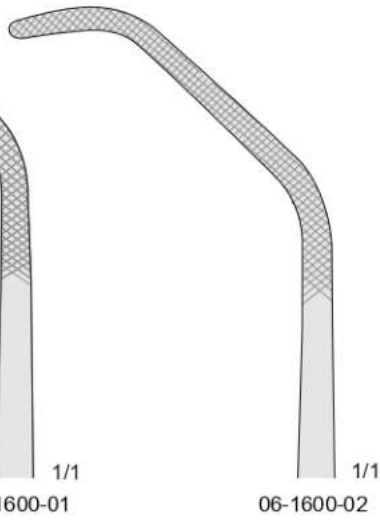
1/1
06-1590-02
220 mm



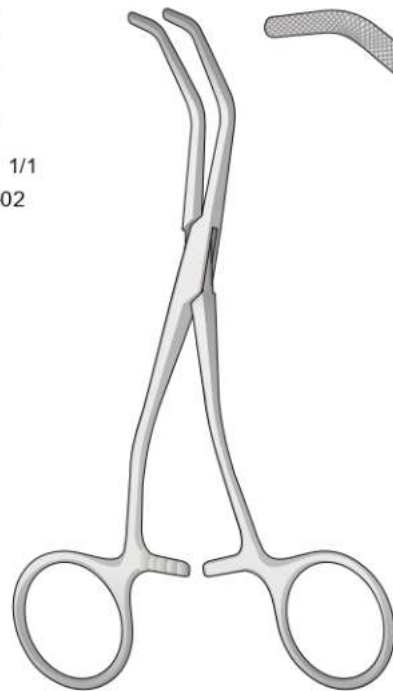
SATINSKY
06-1600
260 mm



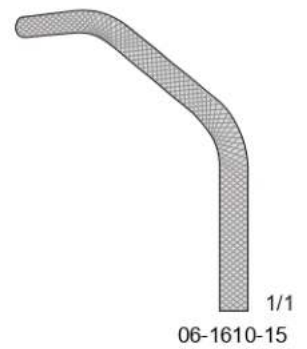
06-1600-01
1/1



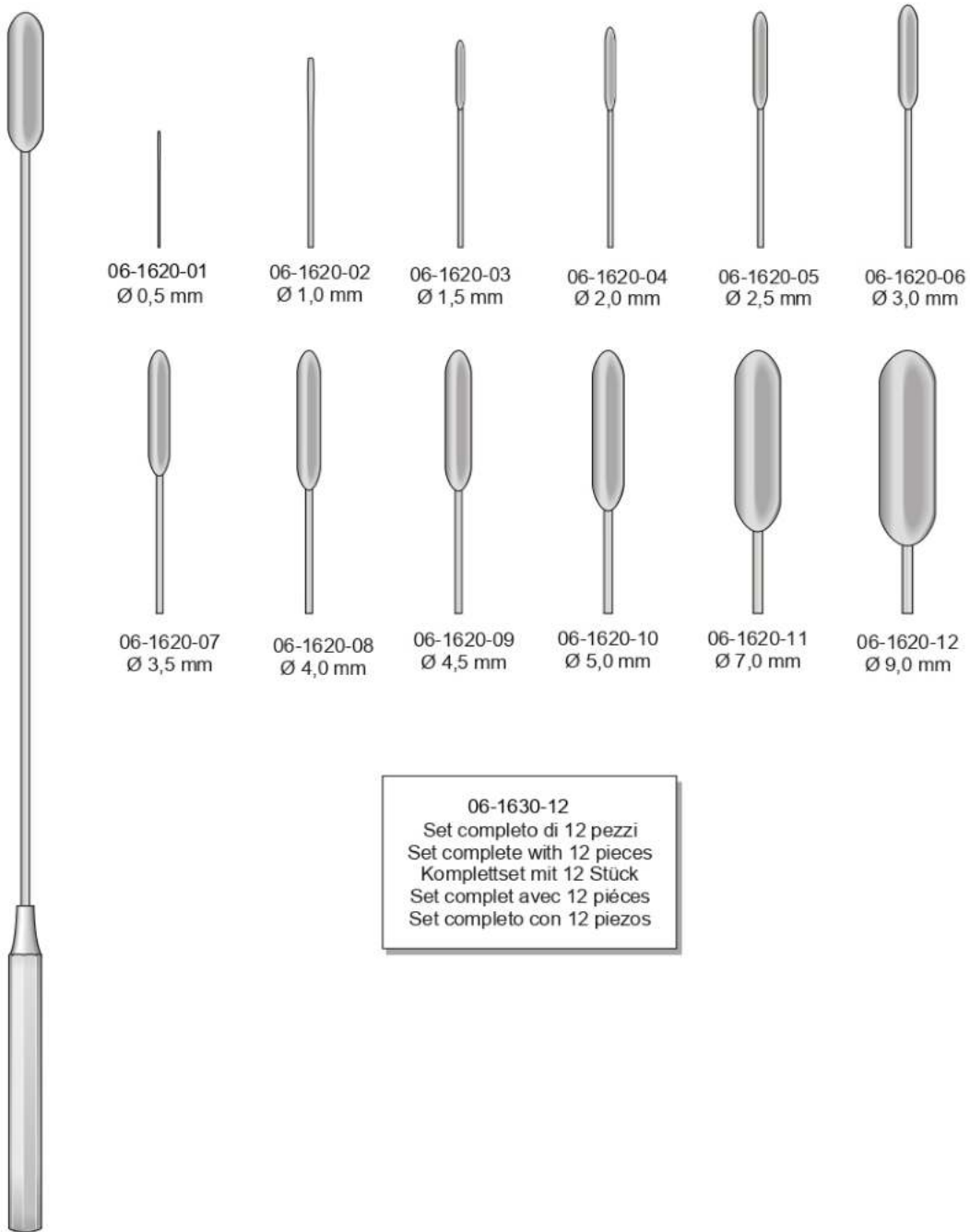
06-1600-02
1/1



BABY-SATINSKY
06-1610
150 mm



06-1610-15
1/1



06-1620-01
Ø 0,5 mm

06-1620-02
Ø 1,0 mm

06-1620-03
Ø 1,5 mm

06-1620-04
Ø 2,0 mm

06-1620-05
Ø 2,5 mm

06-1620-06
Ø 3,0 mm

06-1620-07
Ø 3,5 mm

06-1620-08
Ø 4,0 mm

06-1620-09
Ø 4,5 mm

06-1620-10
Ø 5,0 mm

06-1620-11
Ø 7,0 mm

06-1620-12
Ø 9,0 mm

06-1630-12
Set completo di 12 pezzi
Set complete with 12 pieces
Komplettset mit 12 Stück
Set complet avec 12 pièces
Set completo con 12 piezas

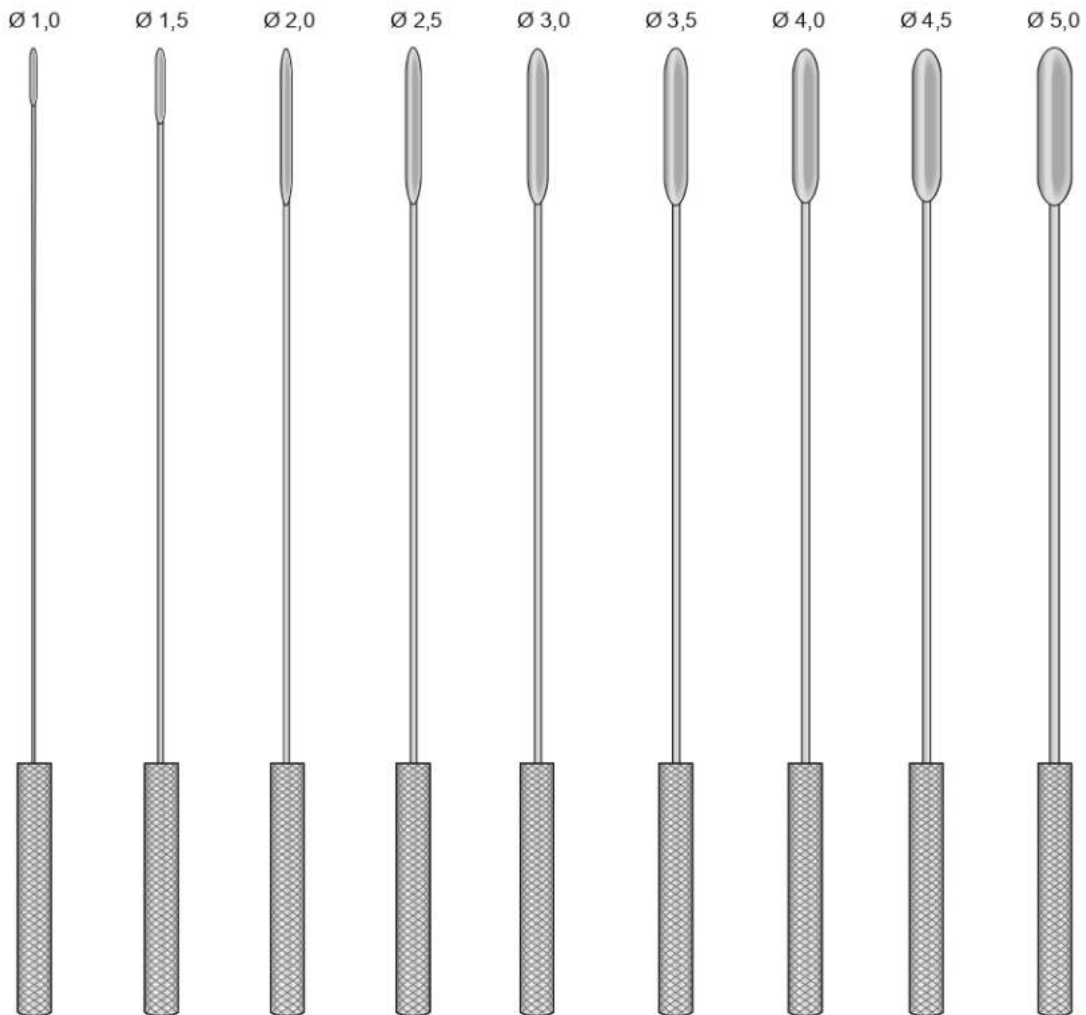
DE BAKEY
06-1620
190 mm

06-1640-01- 140 mm - Ø 1,0
 06-1640-02- 140 mm - Ø 1,5
 06-1640-03- 140 mm - Ø 2,0
 06-1640-04- 140 mm - Ø 2,5
 06-1640-05- 140 mm - Ø 3,0
 06-1640-06- 140 mm - Ø 3,5
 06-1640-07- 140 mm - Ø 4,0
 06-1640-08- 140 mm - Ø 4,5
 06-1640-09- 140 mm - Ø 5,0

06-1640-10- 210 mm - Ø 1,0
 06-1640-11- 210 mm - Ø 1,5
 06-1640-12- 210 mm - Ø 2,0
 06-1640-13- 210 mm - Ø 2,5
 06-1640-14- 210 mm - Ø 3,0
 06-1640-15- 210 mm - Ø 3,5
 06-1640-16- 210 mm - Ø 4,0
 06-1640-17- 210 mm - Ø 4,5
 06-1640-18- 210 mm - Ø 5,0

06-1650-09
 Set completo di 9 pezzi
 Set complete with 9 pieces
 Kompletset mit 9 Stück
 Saet complet avec 9 pièces
 Set completo con 9 piezas

06-1660-09
 Set completo di 9 pezzi
 Set complete with 9 pieces
 Kompletset mit 9 Stück
 Saet complet avec 9 pièces
 Set completo con 9 piezas



GARRETT
06-1640



Ø 2 mm
○ 1/1
06-1670-01

Ø 3 mm
○ 1/1
06-1670-02

Ø 4 mm
○ 1/1
06-1670-03

Ø 6 mm
○ 1/1
06-1670-04

Ø 7 mm
○ 1/1
06-1670-05

Ø 8,5 mm
○ 1/1
06-1670-06

Ø 10 mm
○ 1/1
06-1670-07

Ø 12 mm
○ 1/1
06-1670-08

Ø 14 mm
○ 1/1
06-1670-09

VOLLMAR
06-1670
500 mm



06-1680-12
120 mm



VARADY
06-1690-01
180 mm



VARADY
06-1690-02
180 mm



VARADY
06-1690-03
180 mm

Aghi vascolari malleabili - Gefäßspülkanülen
Ø 3 mm Ø 4 mm Ø 5 mm Ø 6 mm



SCHMID
06-1700-01
150 mm



SCHMID
06-1700-02
150 mm



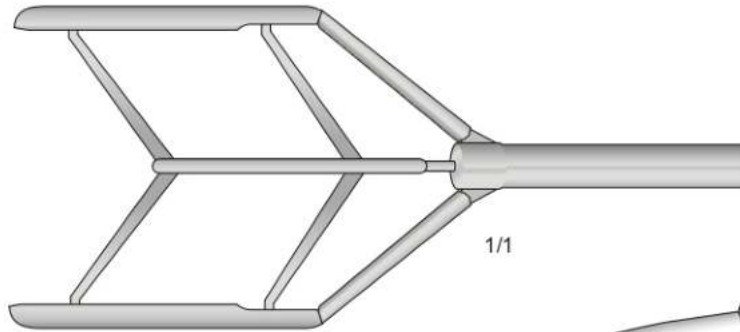
SCHMID
06-1700-03
150 mm



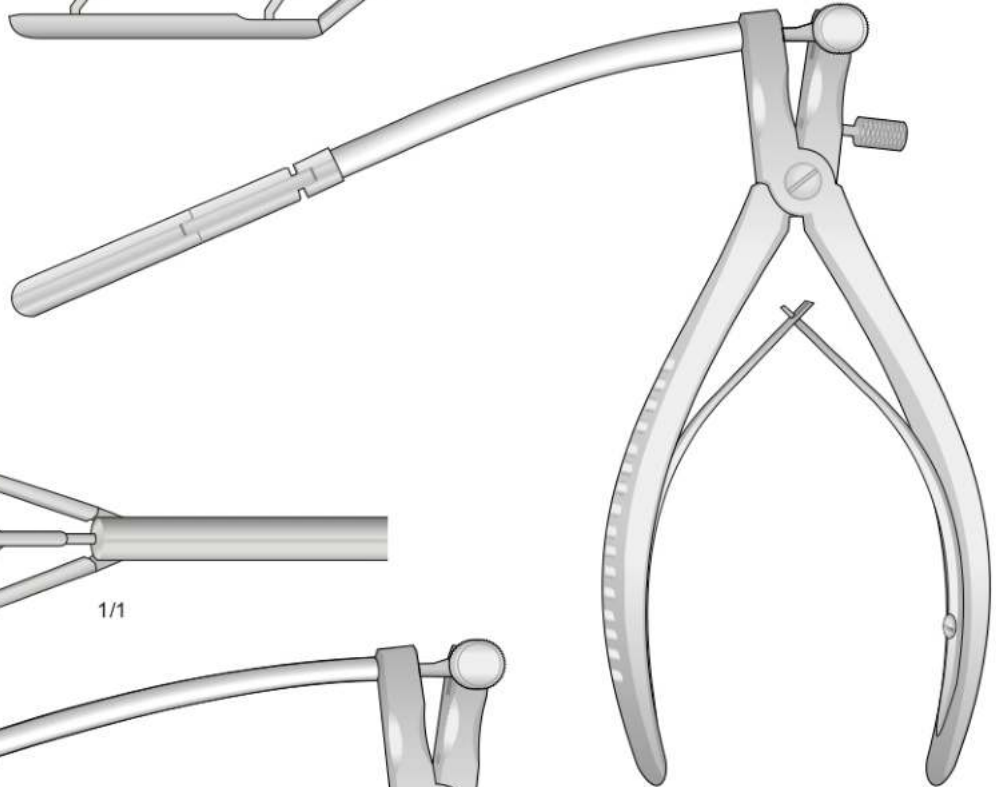
SCHMID
06-1700-04
150 mm



AP. 9-45 mm

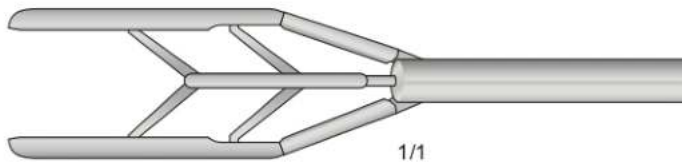


1/1

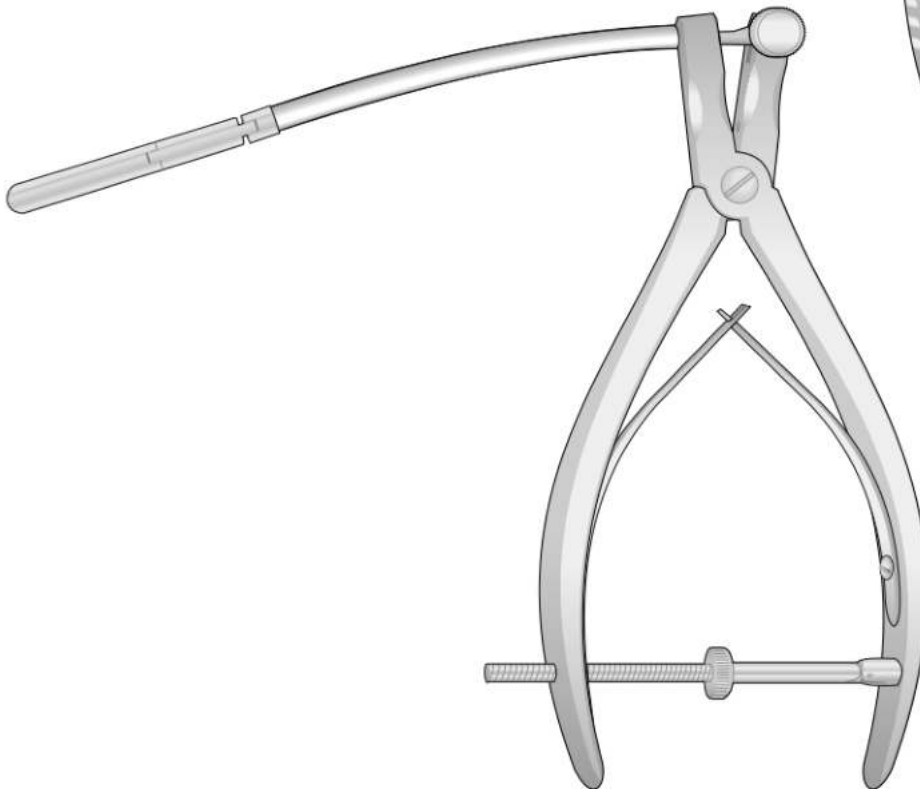


TUBBS
06-1720

AP. 8-15 mm



1/1



COOLEY
06-1710



SAFE TOOL
MANUFACTURER & EXPORTER

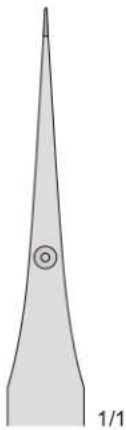
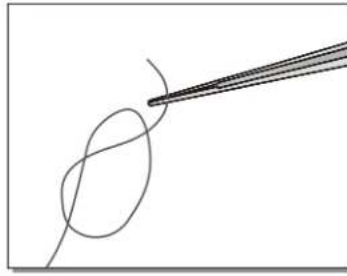


***Needle Holders
Ligature Needles***

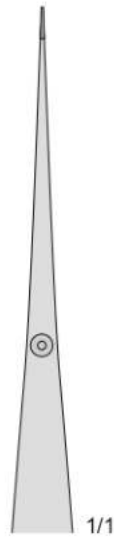


www.safetool.com.pk

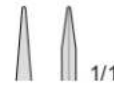
***Surgical
Instruments***



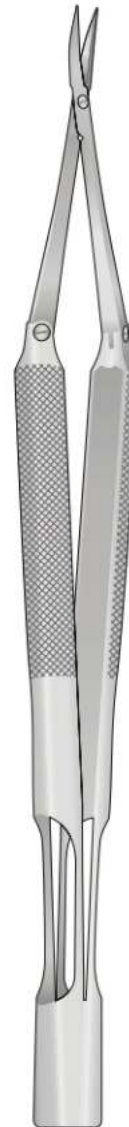
BROCK
ST-8301
130 mm



BROCK
ST-8302
150 mm



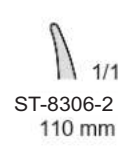
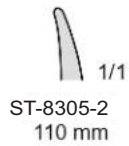
BROCK
ST-8303
150 mm



BROCK
ST-8304
150 mm



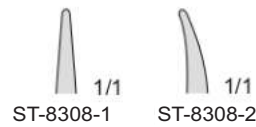
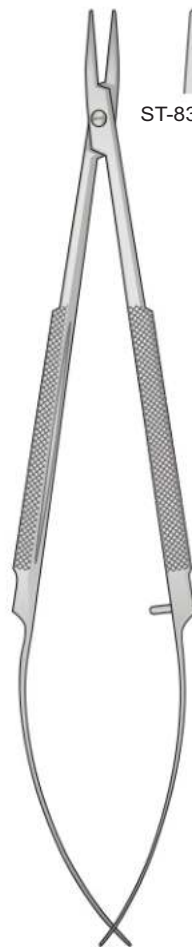
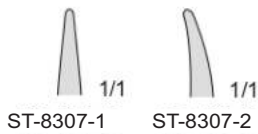
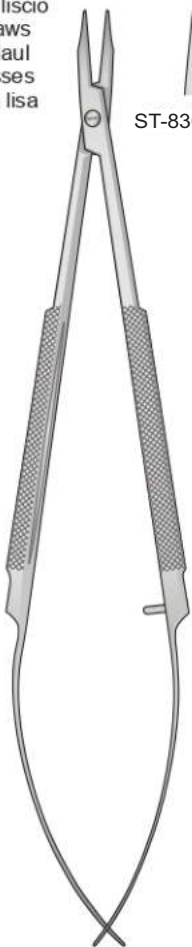
Con morso liscio
Smooth jaws
Glattes Maul
A' mors lisses
Mandibula lisa



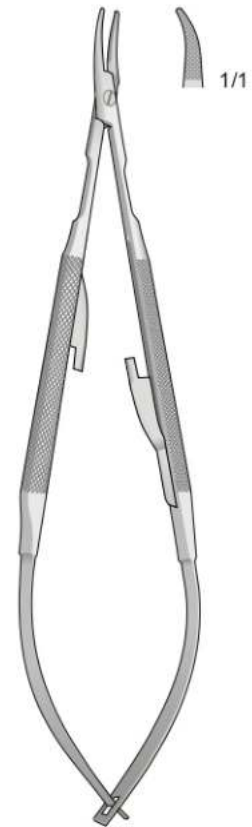
ST-8305
110 mm

ST-8306
110 mm

Con morso liscio
Smooth jaws
Glattes Maul
A' mors lisses
Mandibula lisa



Con morso zigrinato fine
Fine serrated jaws
Feingeriffes Maul
Mors stries fins
Bocas estriadas finas



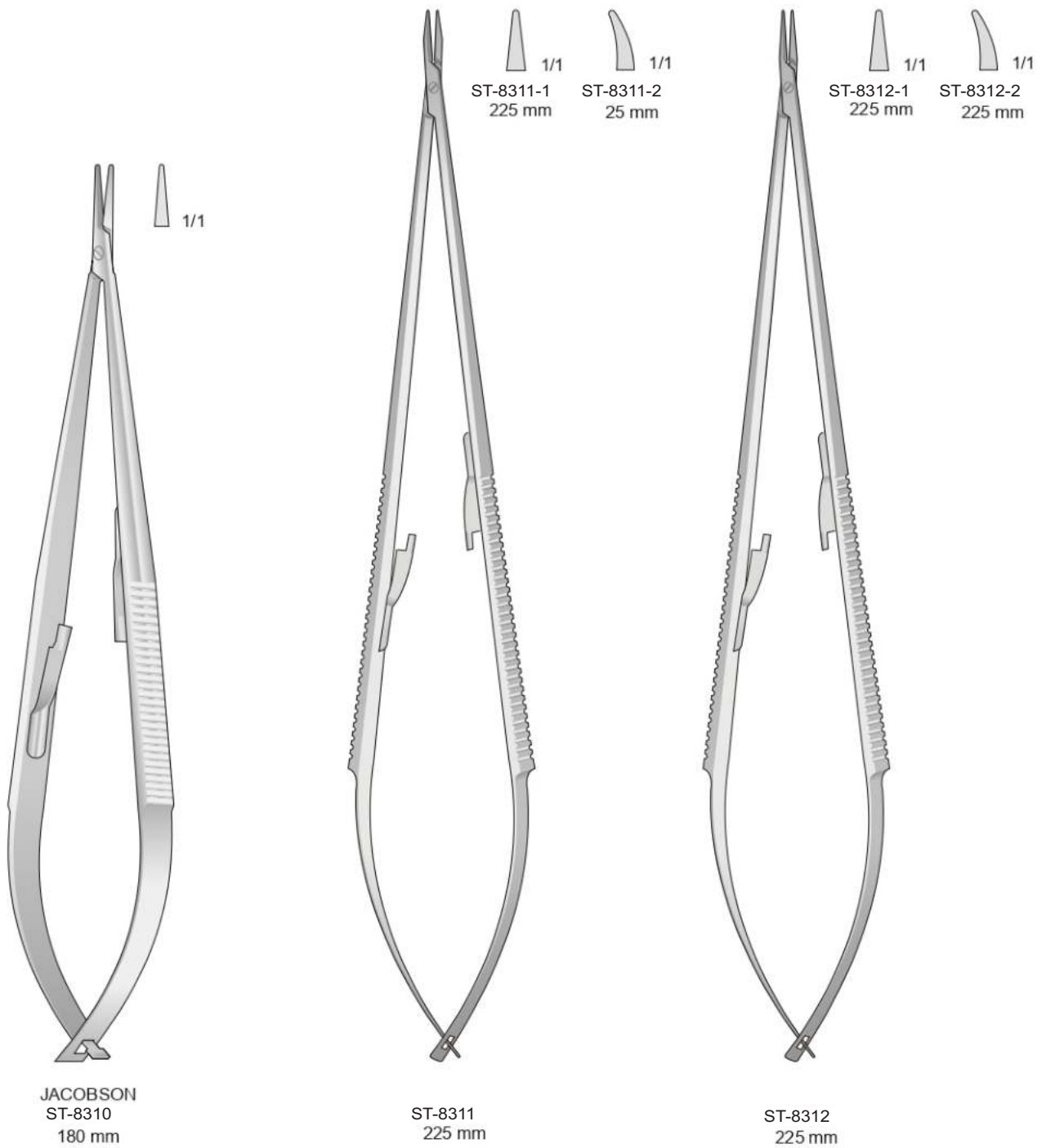
ST-8307
150 mm

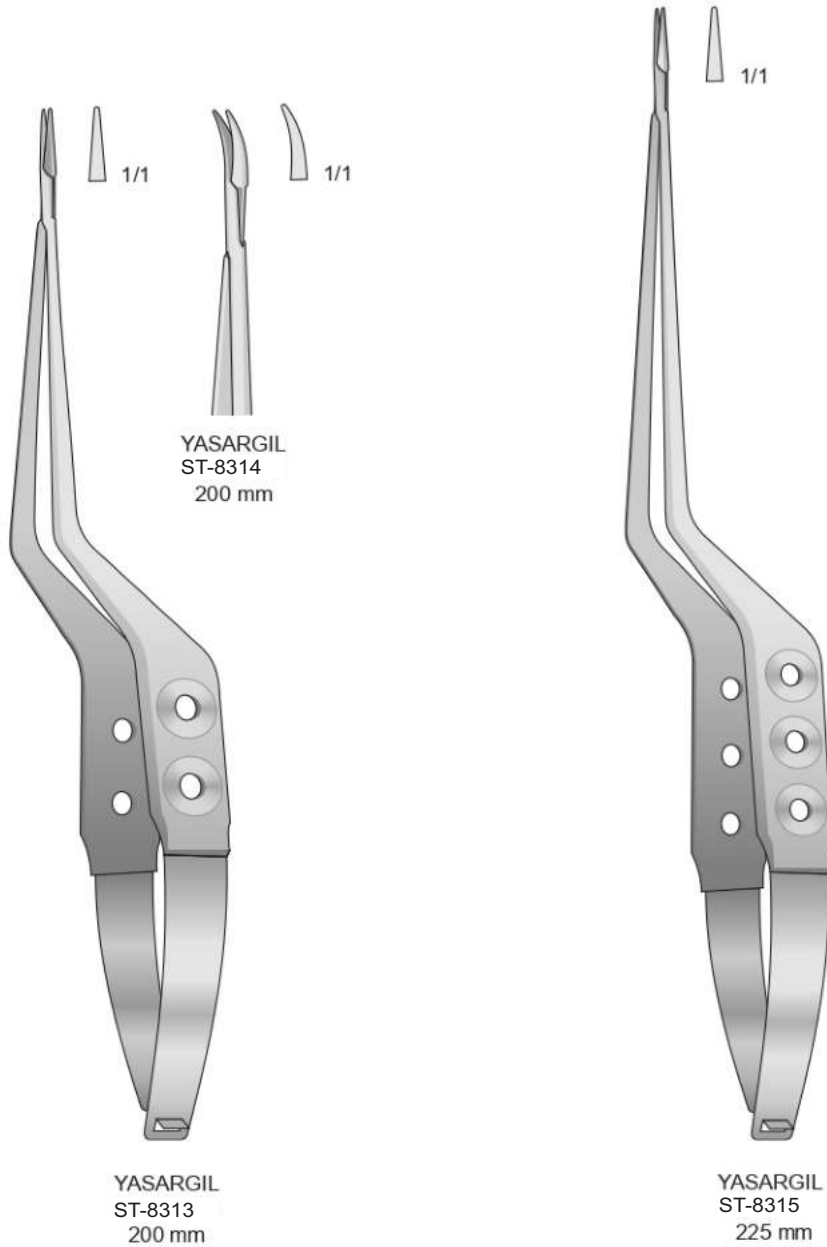
ST-8308
150 mm

BARRAQUER
ST-8309
135 mm



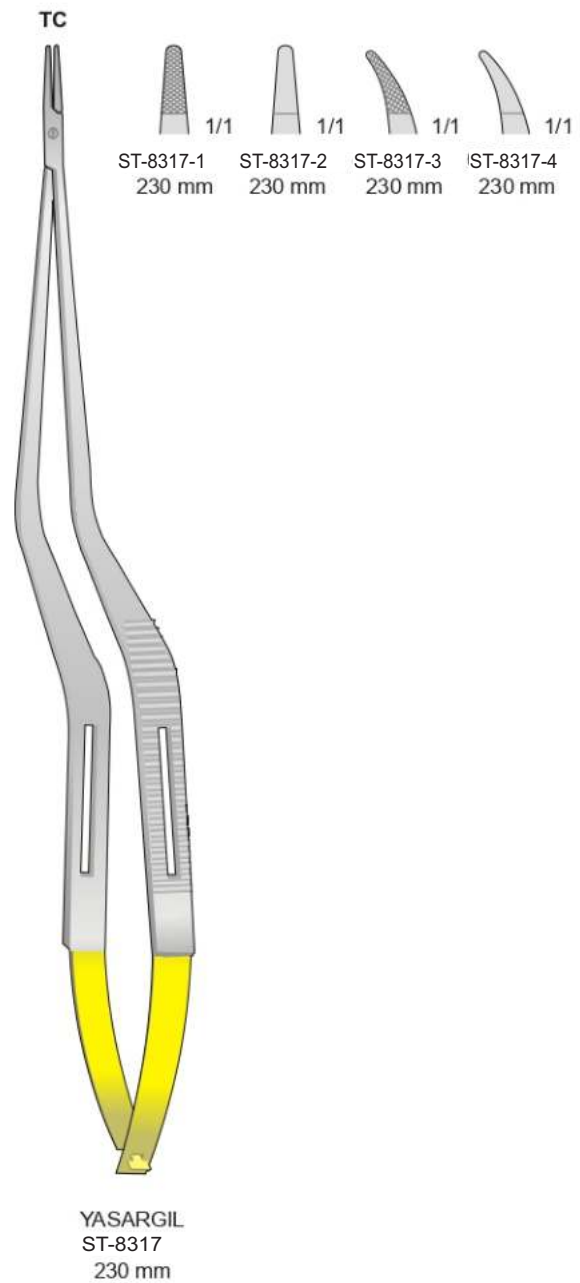
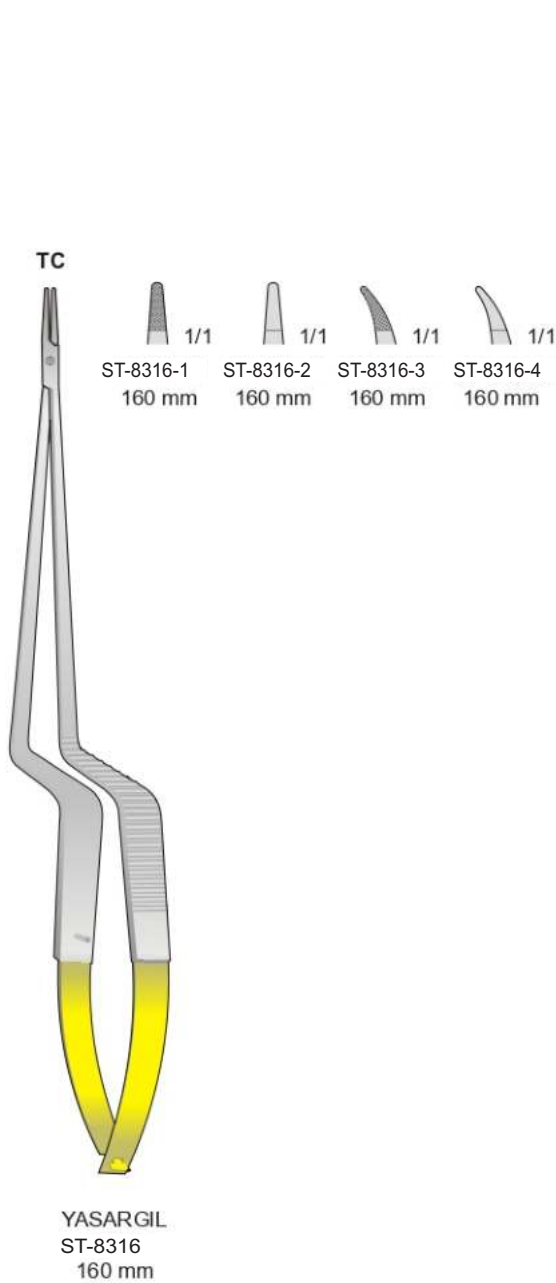
Con morso liscio - Smooth jaws
Glattes Maul - A' mors lisses - Mandibula lisa





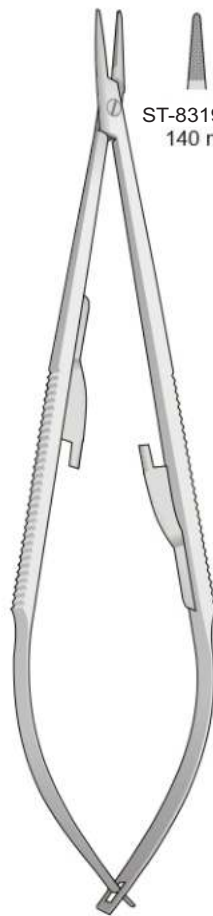
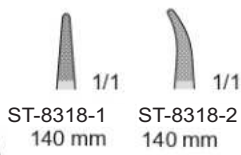


Portaghi con inserti al tungsteno
Needle Holders with tungsten-carbide inserts
Nadelhalter mit Hartmetalleinlagen
Porte aiguilles avec plaquettes en carbure de tungstène
Portaaguja con plaquitas de carburo de tungsteno

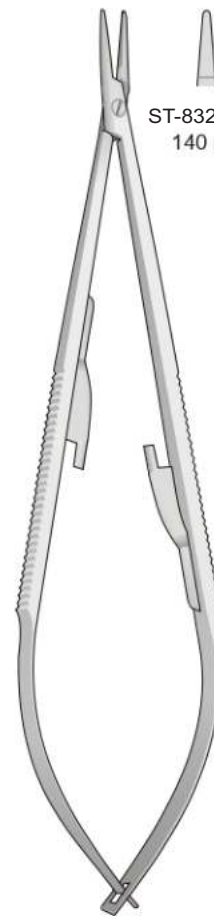
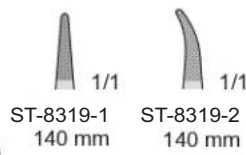




07-330
140 mm



CASTROVIEJO
ST-8319
140 mm



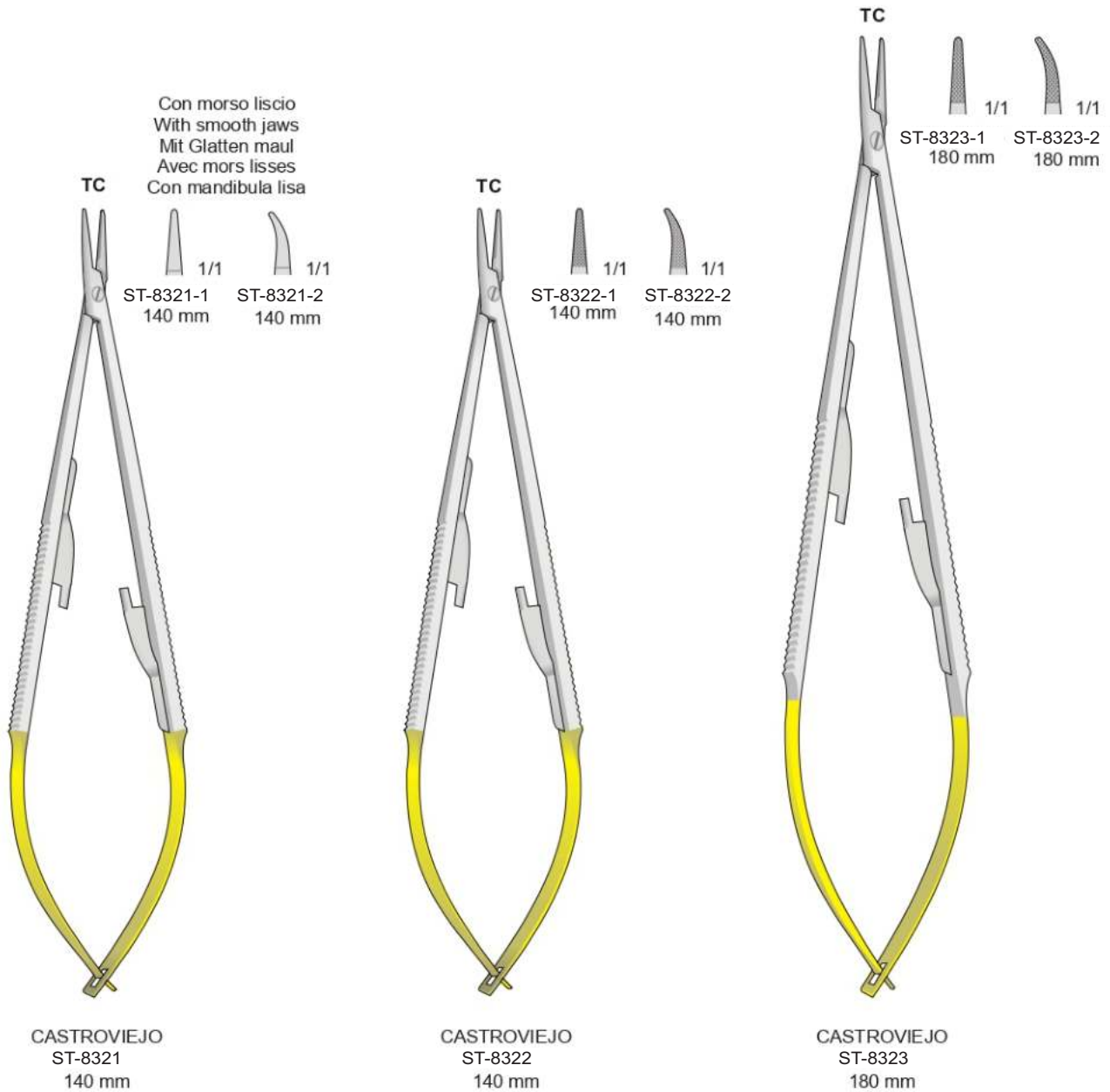
CASTROVIEJO
ST-8320
140 mm

Con morso liscio
With smooth jaws
Mit Glatten maul
Avec mors lisses
Con mandibula lisa

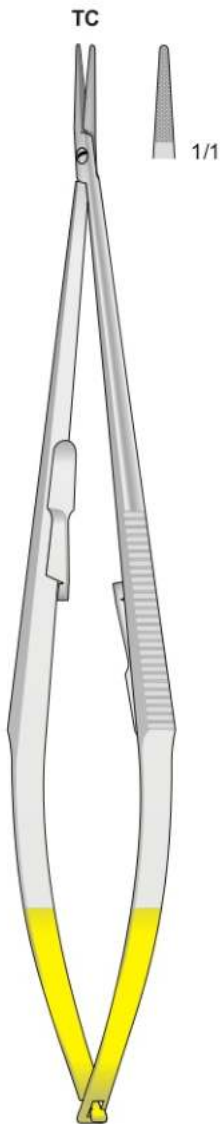
ST-8320-1
140 mm

ST-8320-2
140 mm

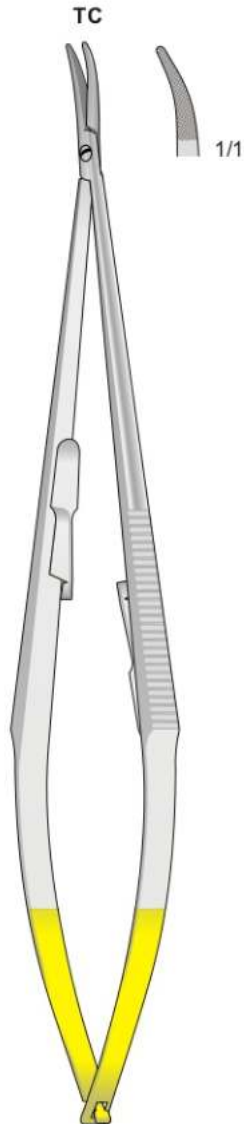
Portaghi con inserti al tungsteno
Needle Holders with tungsten-carbide inserts
Nadelhalter mit Hartmetalleinlagen
Porte aiguilles avec plaquettes en carbure de tungstène
Portaagujas con plaquitas de carburo de tungsteno



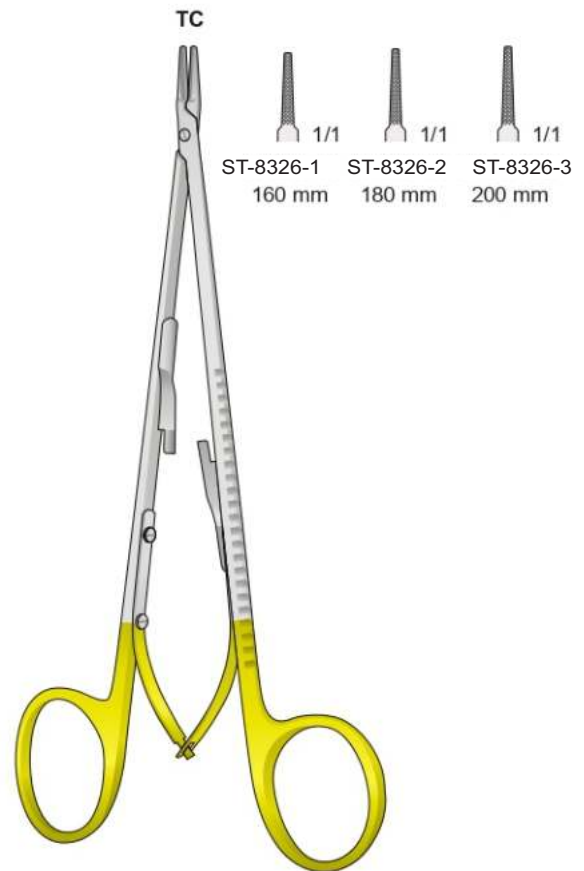
Portaghi con inserti al tungsteno
 Needle Holders with tungsten-carbide inserts
 Nadelhalter mit Hartmetalleinlagen
 Porte aiguilles avec plaquettes en carbure de tungstène
 Portaaguja con plaquitas de carburo de tungsteno



CASTROVIEJO
ST-8324
215 mm

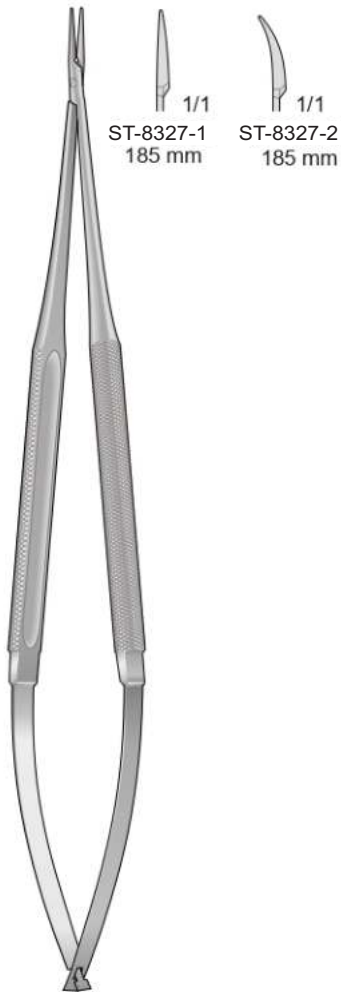


CASTROVIEJO
ST-8325
215 mm



DIETRICH
ST-8326

Con morso liscio
With smooth jaws
Mit Glatten maul
Avec mors lisses
Con mandibula lisa



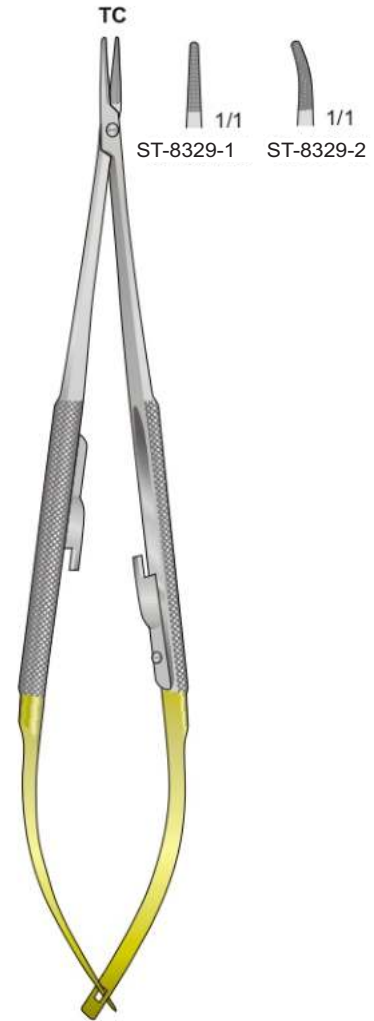
ST-8327
185 mm

Con morso liscio
With smooth jaws
Mit Glatten maul
Avec mors lisses
Con mandibula lisa



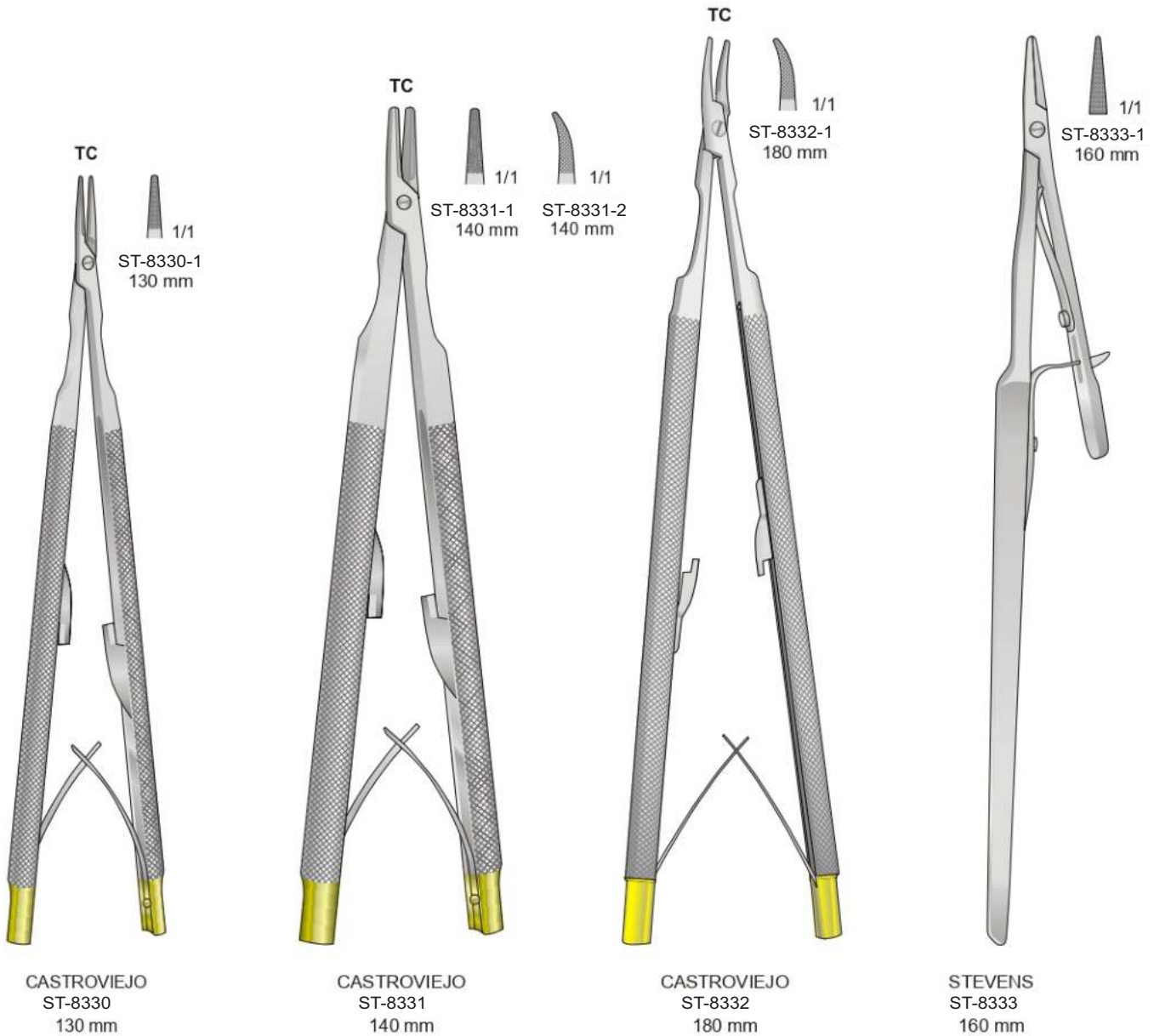
ST-8328
185 mm

Portaghi con inserti al tungsteno
Needle Holders with tungsten-carbide inserts
Nadelhalter mit Hartmetalleinlagen
Porte aiguilles avec plaquettes en carbure de tungstène
Portaagujas con plaquetas de carburo de tungsteno



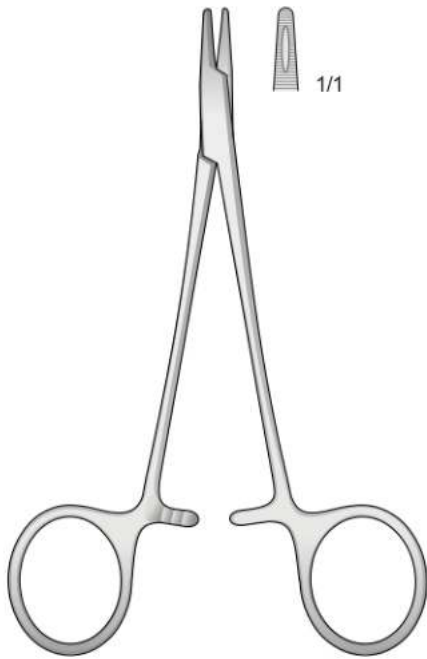
JACOBSON
ST-8329
180 mm

Portaghi con inserti al tungsteno
Needle Holders with tungsten-carbide inserts
Nadelhalter mit Hartmetalleinlagen
Porte aiguilles avec plaquettes en carbure de tungstène
Portaagujas con plaquitas de carburo de tungsteno

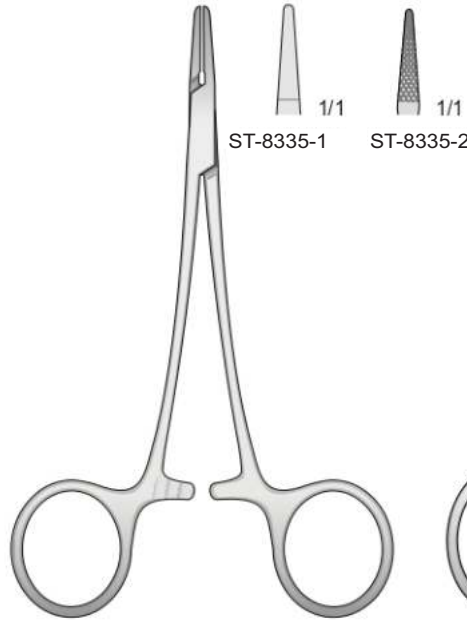




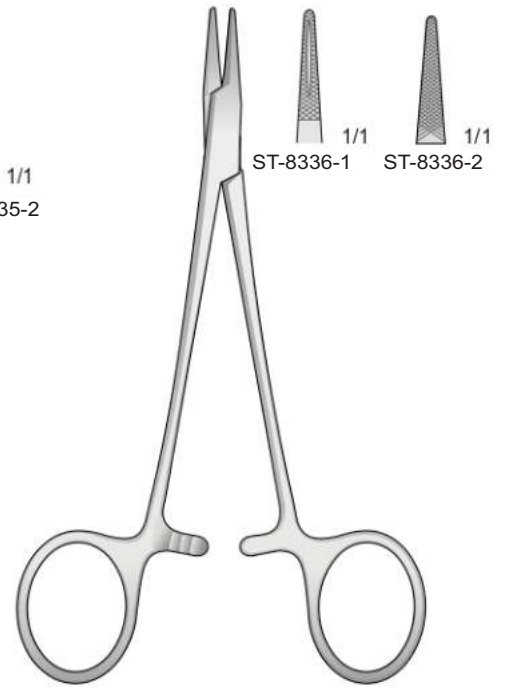
Con morso liscio
With smooth jaws
Mit Glatten maul
Avec mors lisses
Con mandibula lisa



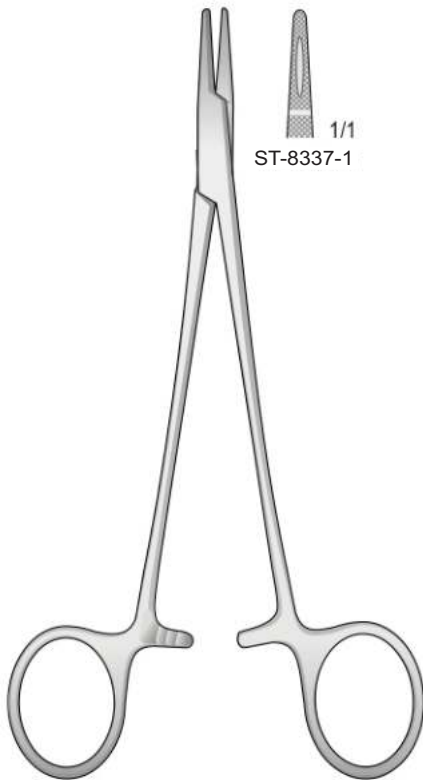
DERF
ST-8334
125 mm



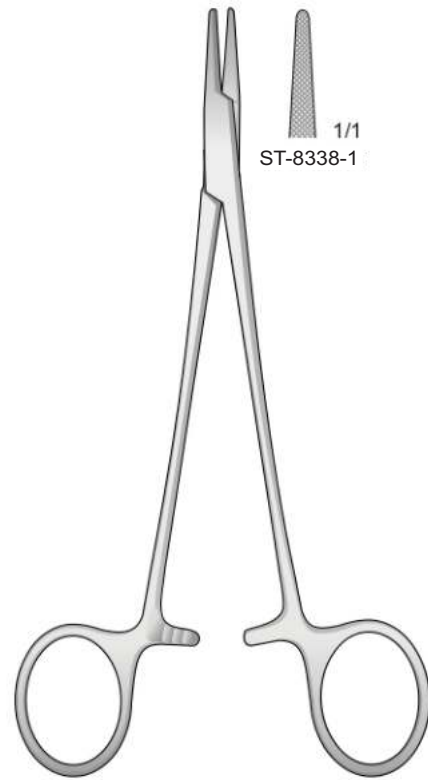
ST-8335
120 mm



HALSEY
ST-8336
130 mm



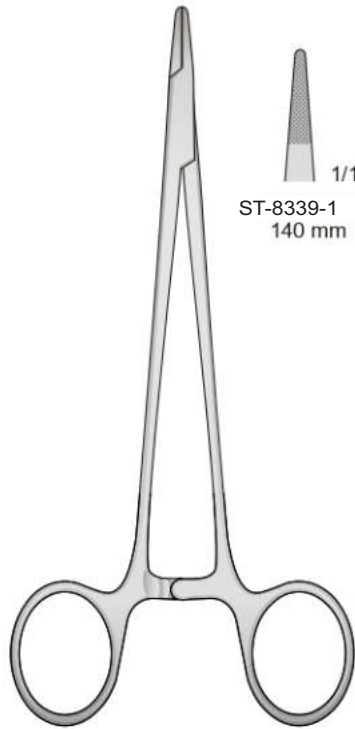
CRILE-WOOD
ST-8337
150 mm



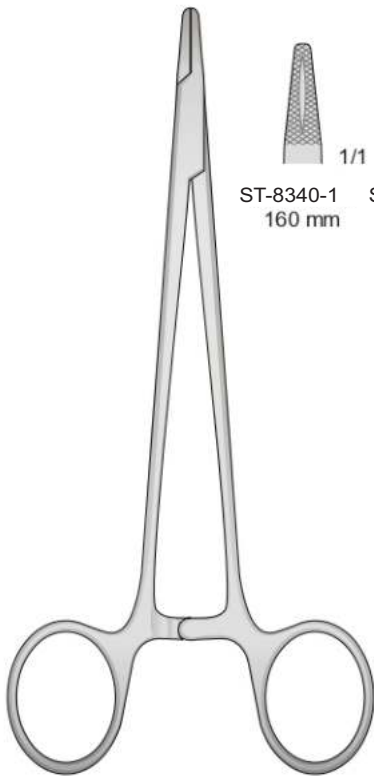
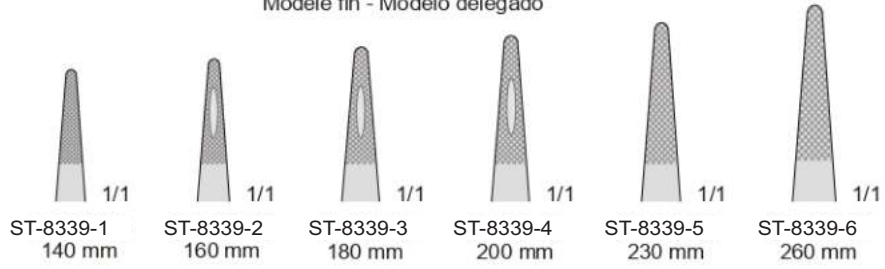
CRILE-MURRAY
ST-8338
150 mm



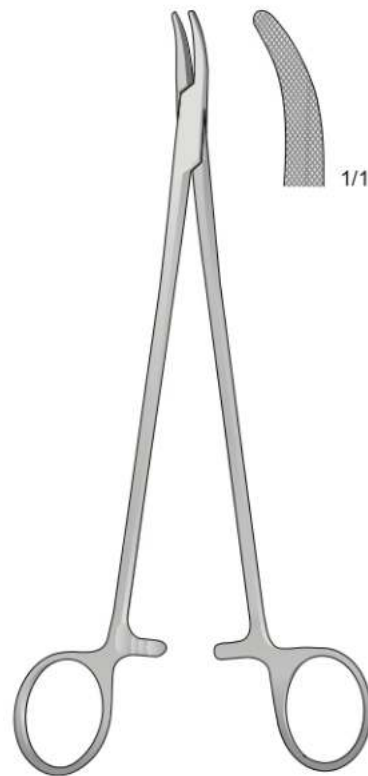
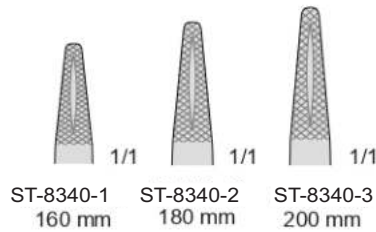
Modello fine - Delicate pattern - Schlankesmodell
Modèle fin - Modelo delegado



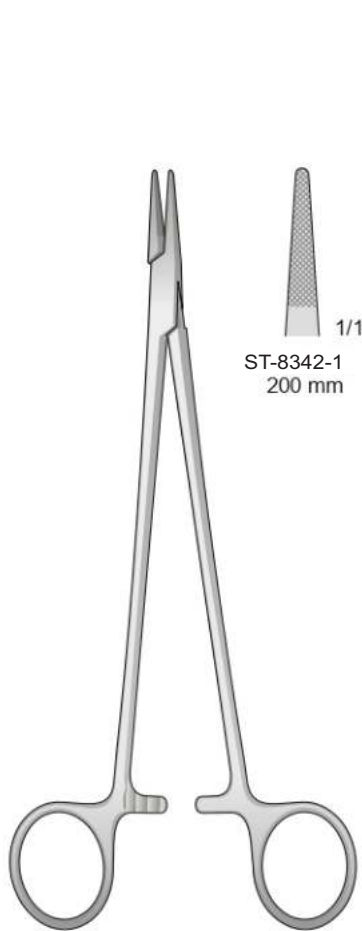
MAYO-HEGAR
ST-8339



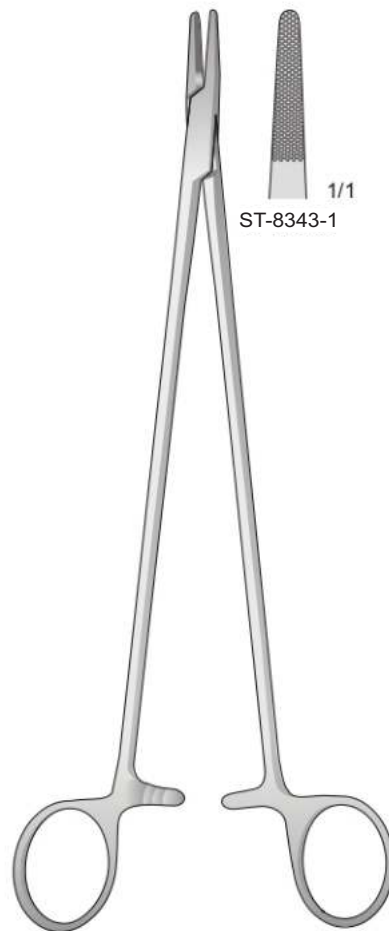
HEGAR
ST-8340



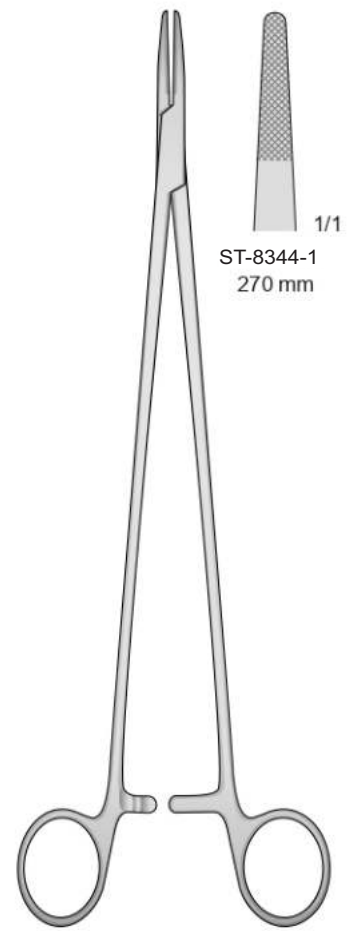
HEANEY (HEGAR)
ST-8341
200 mm



HEGAR-MAYO-SEELEY
ST-8342
200 mm



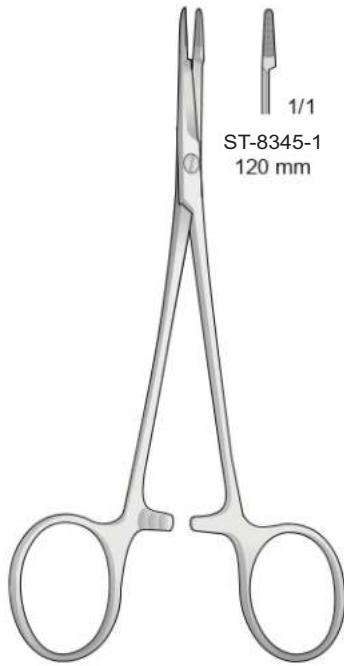
MASSON
ST-8343
270 mm



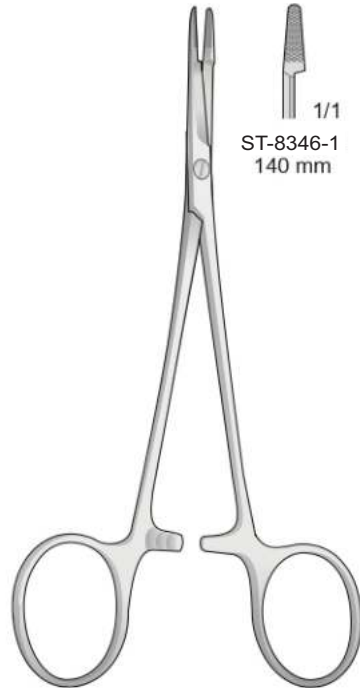
WANGENSTEEN
ST-8344
270 mm



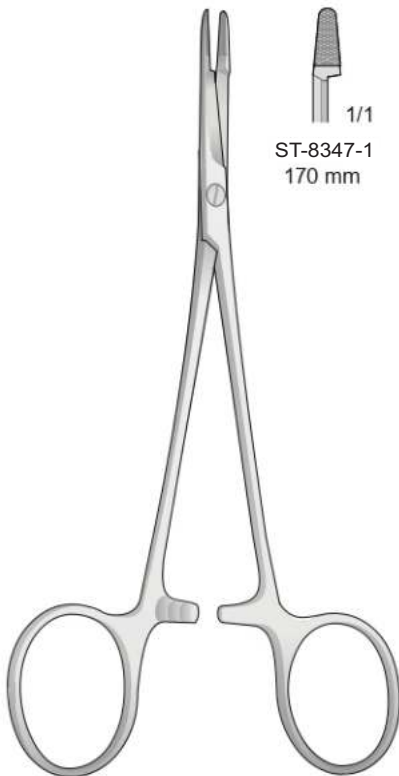
Port'aghi con forbici - Needle holders with scissors - Nadelhalter mit Schere - Porte aiguilles avec ciseaux - Portaagujas con tijeras



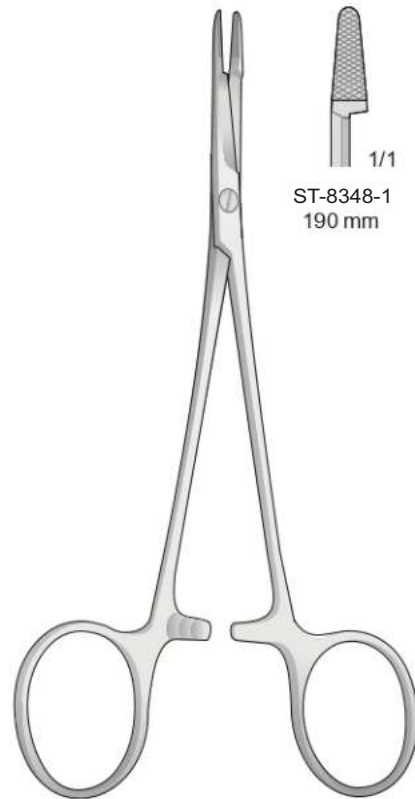
MINI-OLSEN-HEGAR
ST-8345
120 mm



OLSEN-HEGAR
ST-8346
140 mm



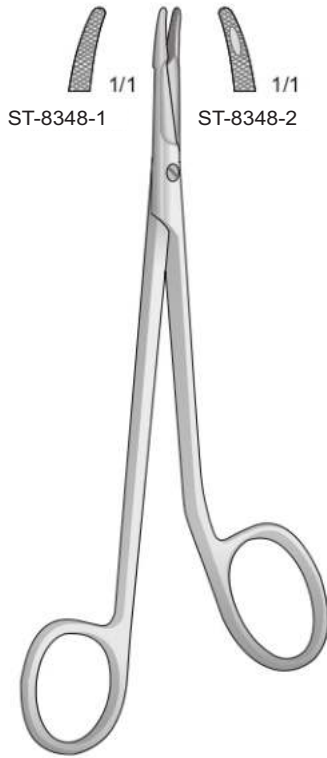
OLSEN-HEGAR
ST-8347
170 mm



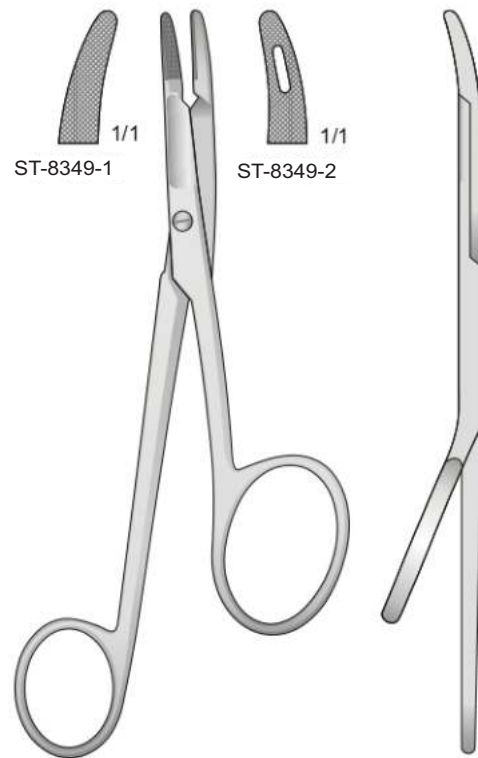
OLSEN-HEGAR
ST-8348
190 mm



Port'aghi con forbici - Needle holders with scissors - Nadelhalter mit Schere - Porte aiguilles avec ciseaux - Portaagujas con tijeras



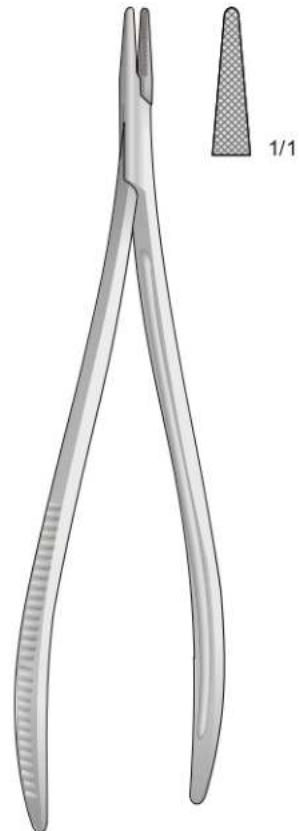
MINI-GILLIES
ST-8348
145 mm



GILLIES
ST-8349
160 mm



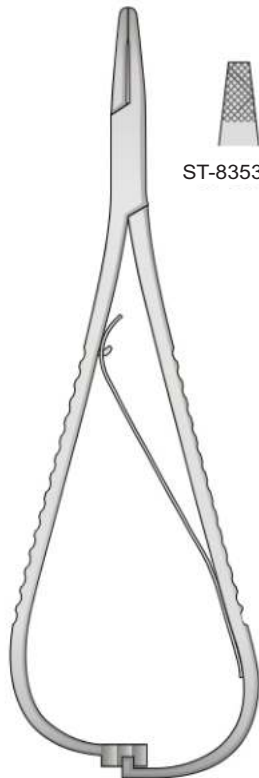
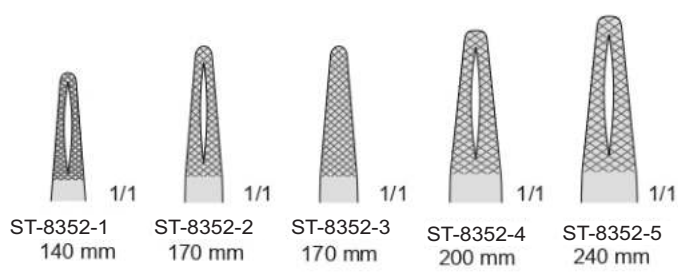
CRILE
ST-8350
150 mm



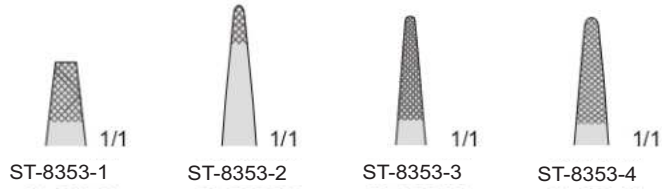
TÖNNIS
ST-8351
190 mm

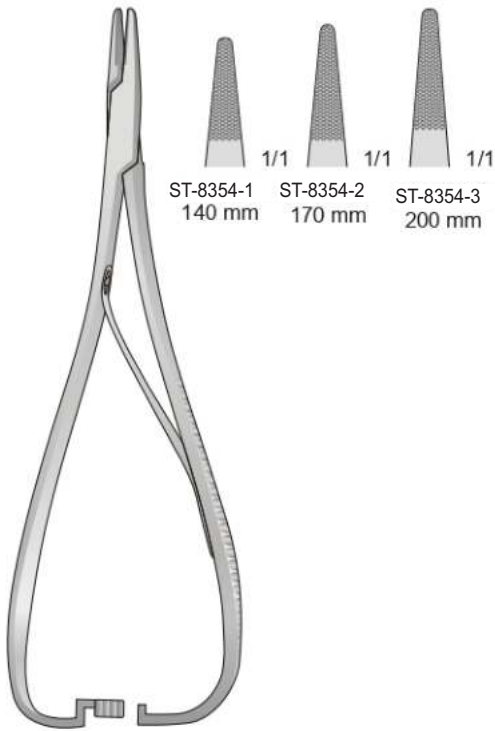


MATHIEU
ST-8352



MATHIEU
ST-8353
140 mm





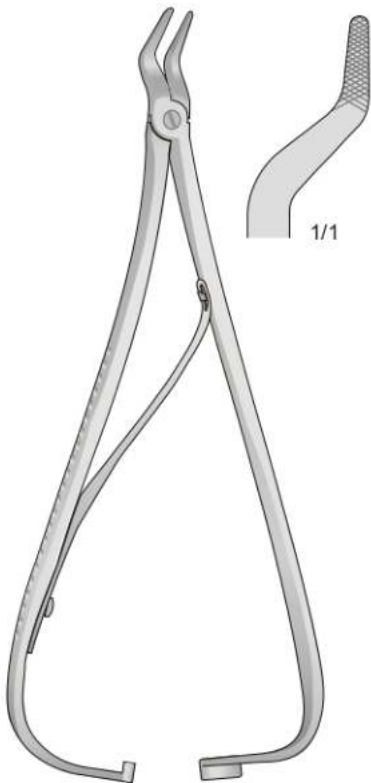
MATHIEU
ST-8354



ST-8355
140 mm



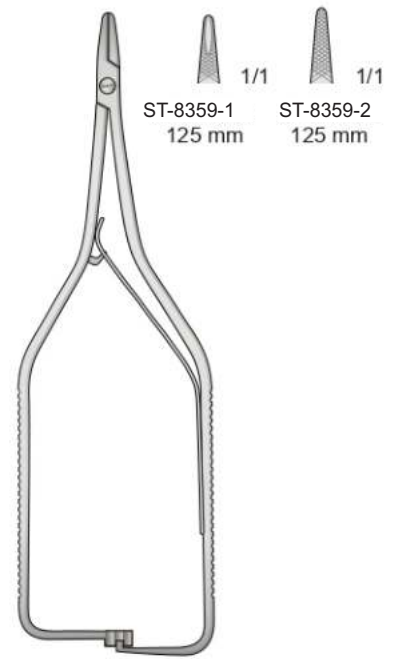
STILLE
ST-8356
170 mm



EISELBERG-MATHIEU
ST-8357
180 mm

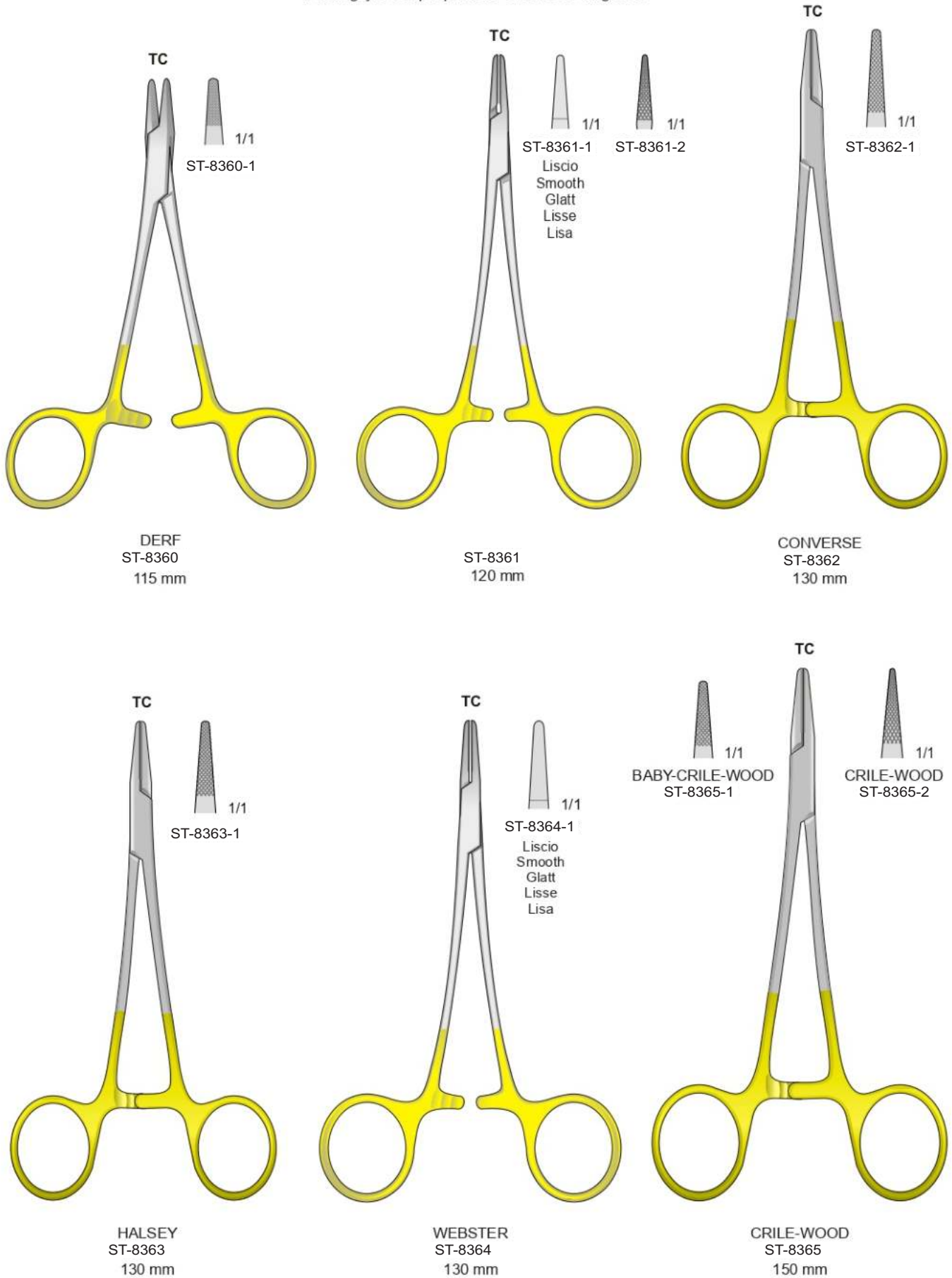


MATHIEU
ST-8358
200 mm



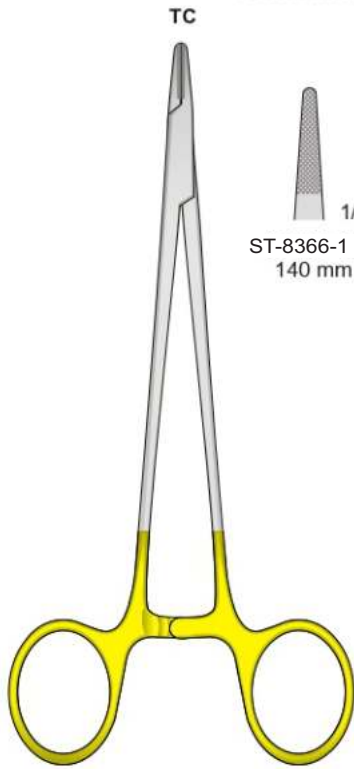
BOYNTON
ST-8359
125 mm

Portaghi con inserti al tungsteno - Needle Holders with tungsten-carbide inserts
Nadelhalter mit Hartmetalleinlagen - Porte aiguilles avec plaquettes en carbure de tungstène
Portaagujas con plaquetas de carburo de tungsteno

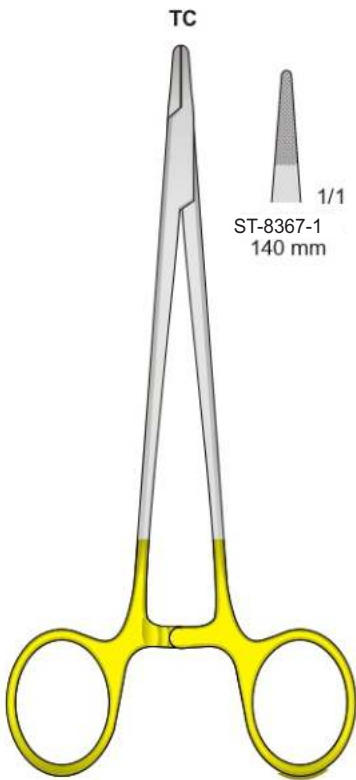
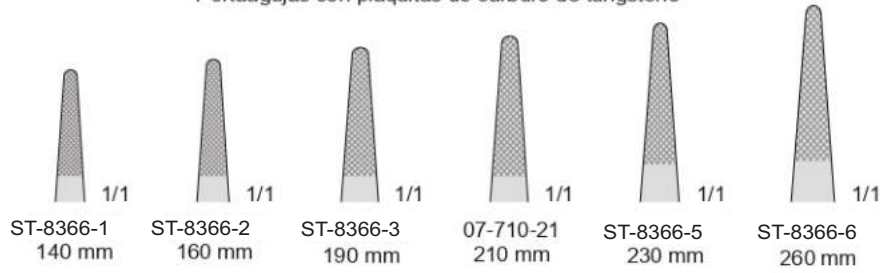




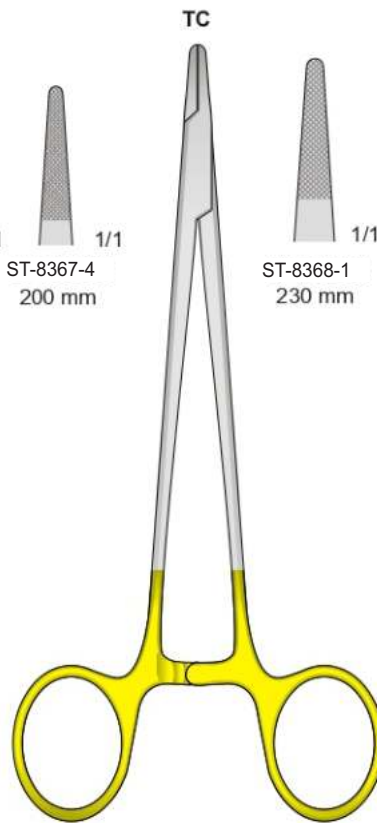
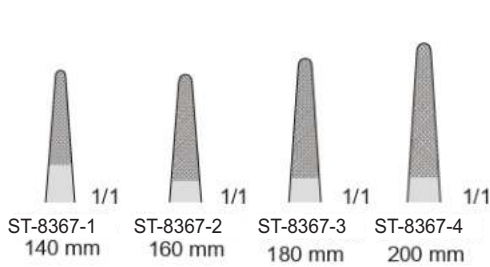
Portaghi con inserti al tungsteno - Needle Holders with tungsten-carbide inserts
Nadelhalter mit Hartmetalleinlagen - Porte aiguilles avec plaquettes en carbure de tungstène
Portaagujas con plaquitas de carburo de tungsteno



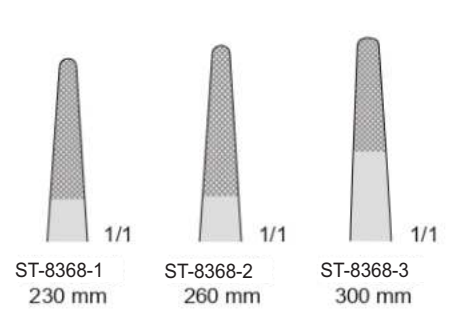
MAYO-HEGAR
ST-8366

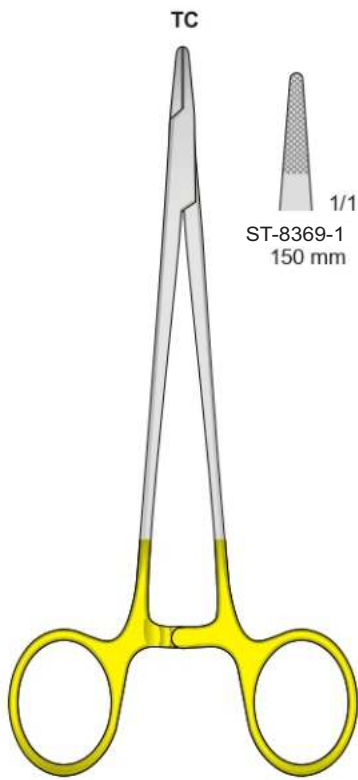


ST-8367
07-720

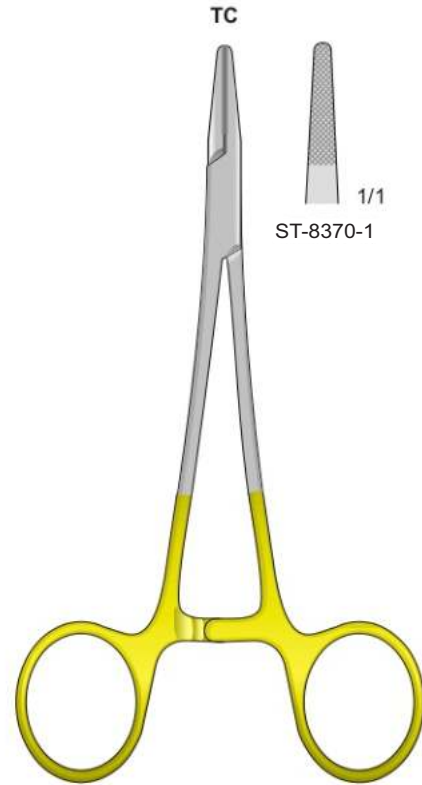


MAYO-HEGAR
ST-8368



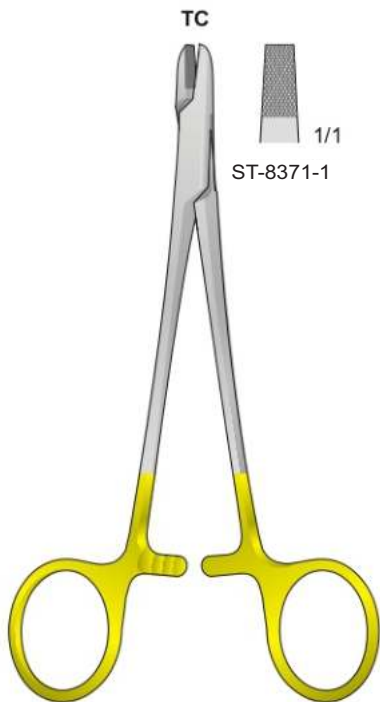


MAYO-HEGAR-FINO
ST-8369



CRILE-WOOD
ST-8370
180 mm

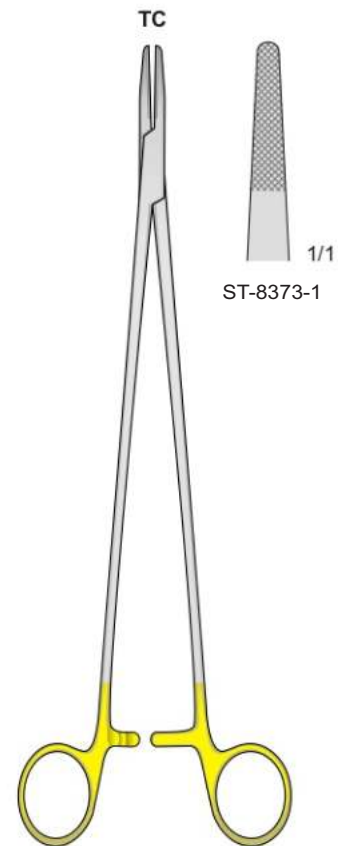
Port'aghi, pinze per fili d'acciaio
Needle holder, wire forceps
Nadelhalter, Draht-Zangen
Porte-aiguilles, pinces à saisir
Porta agujas, pinzas para hilos



ST-8371
150 mm



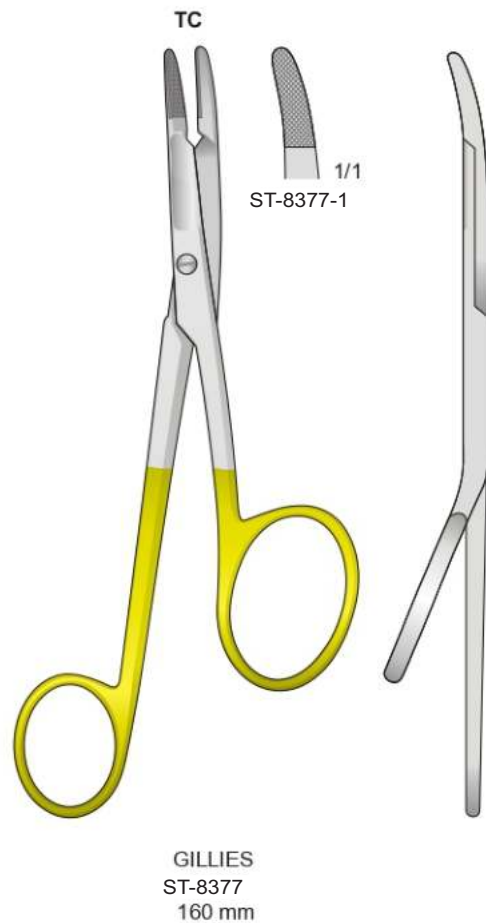
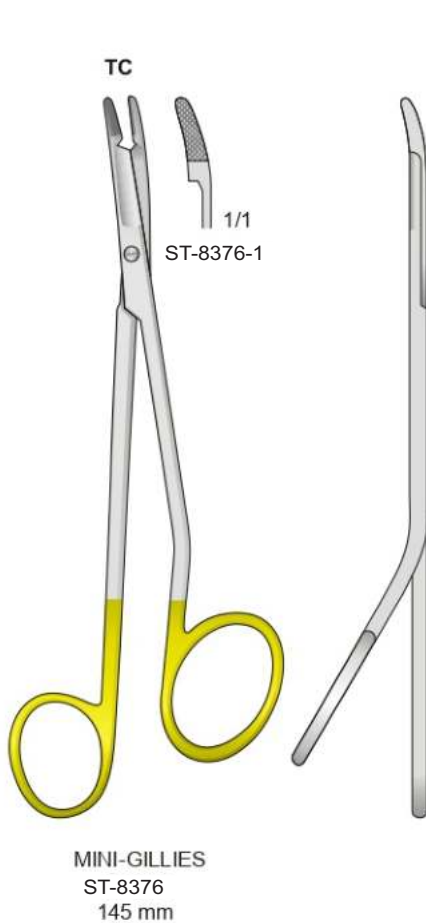
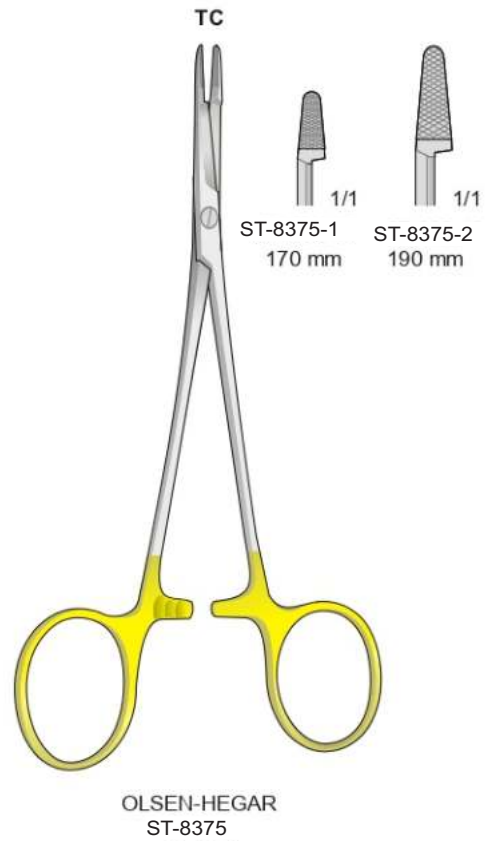
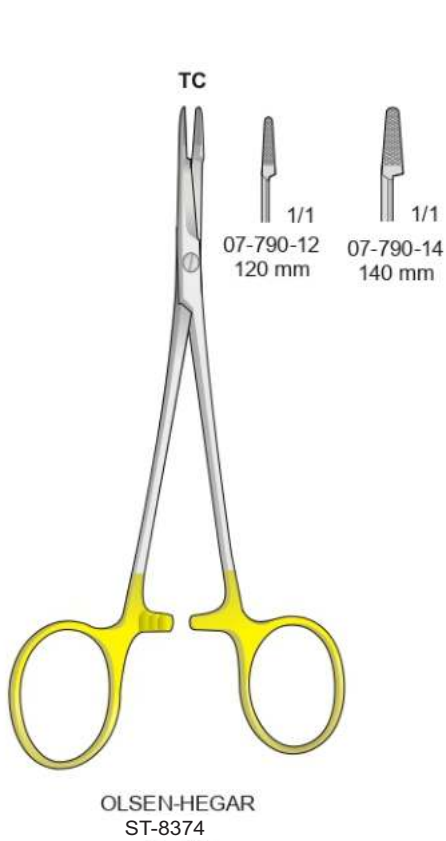
HEGAR-MAYO-SEELEY
ST-8372
200 mm



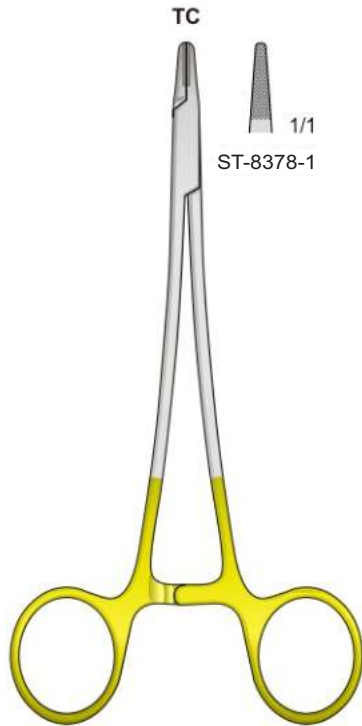
WANGENSTEEN
ST-8373
270 mm



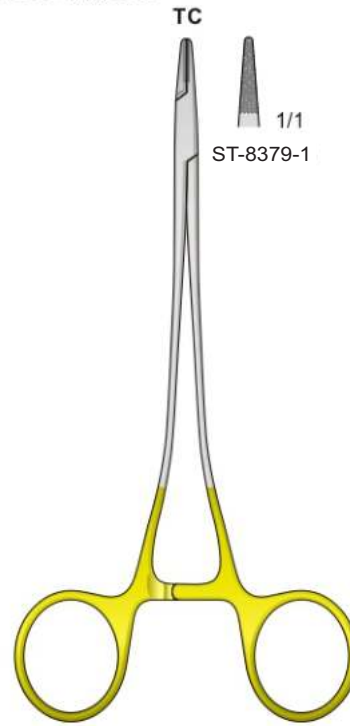
Port'aghi con forbici - Needle holders with scissors - Nadelhalter mit Schere - Porte aiguilles avec ciseaux - Portaagujas con tijeras



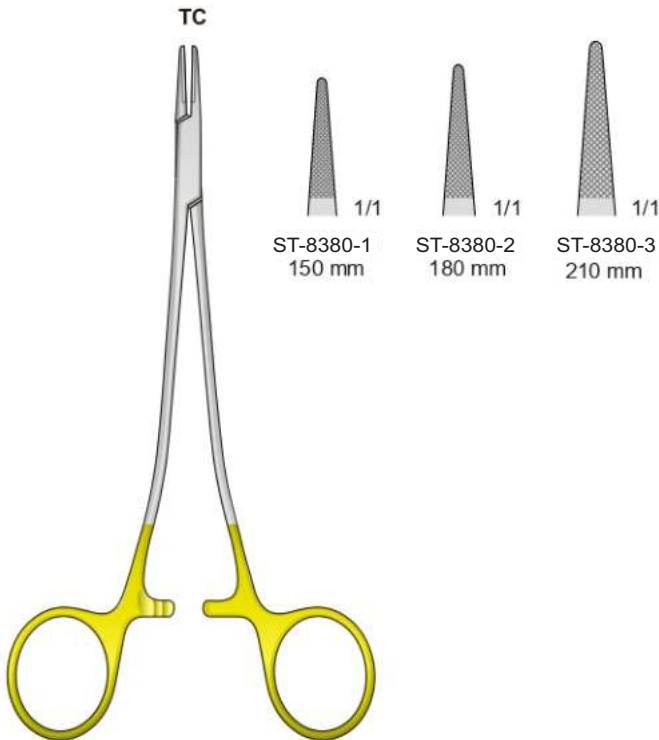
Portaghi con inserti al tungsteno - Needle Holders with tungsten-carbide inserts
Nadelhalter mit Hartmetalleinlagen - Porte aiguilles avec plaquettes en carbure de tungstène
Portaagujas con plaquitas de carburo de tungsteno



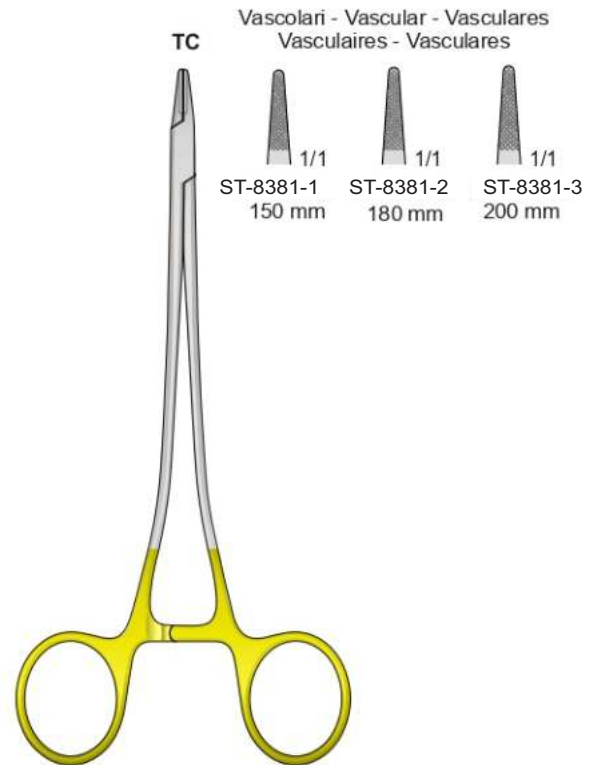
ST-8378
145 mm



ST-8379
150 mm



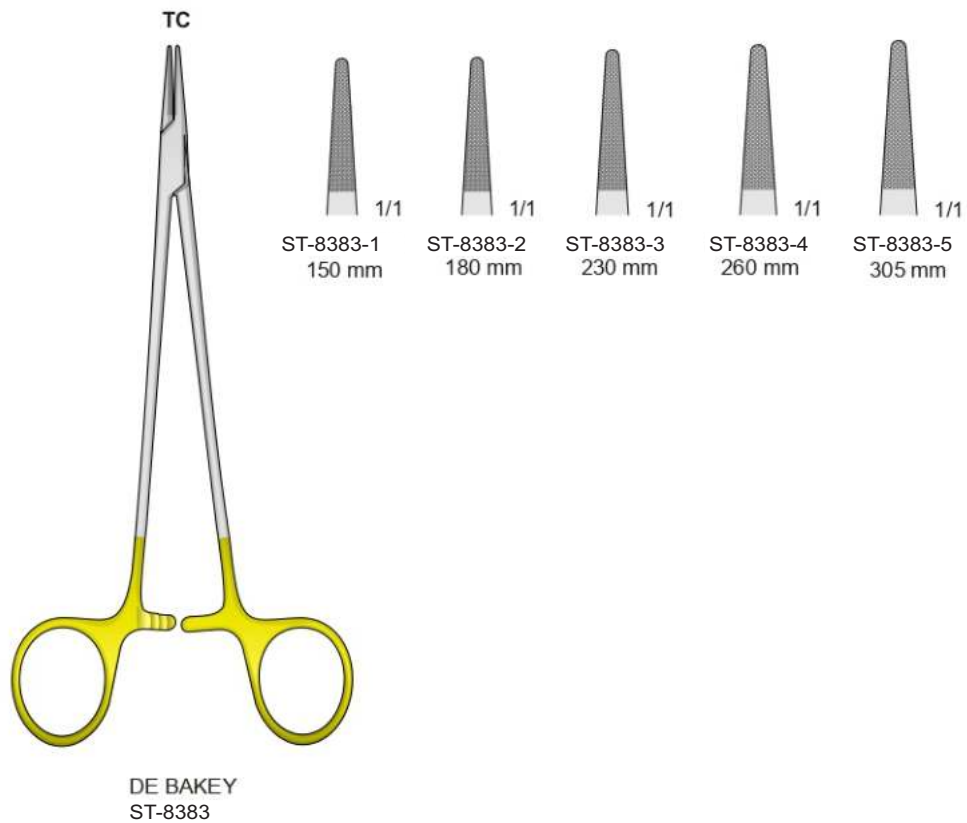
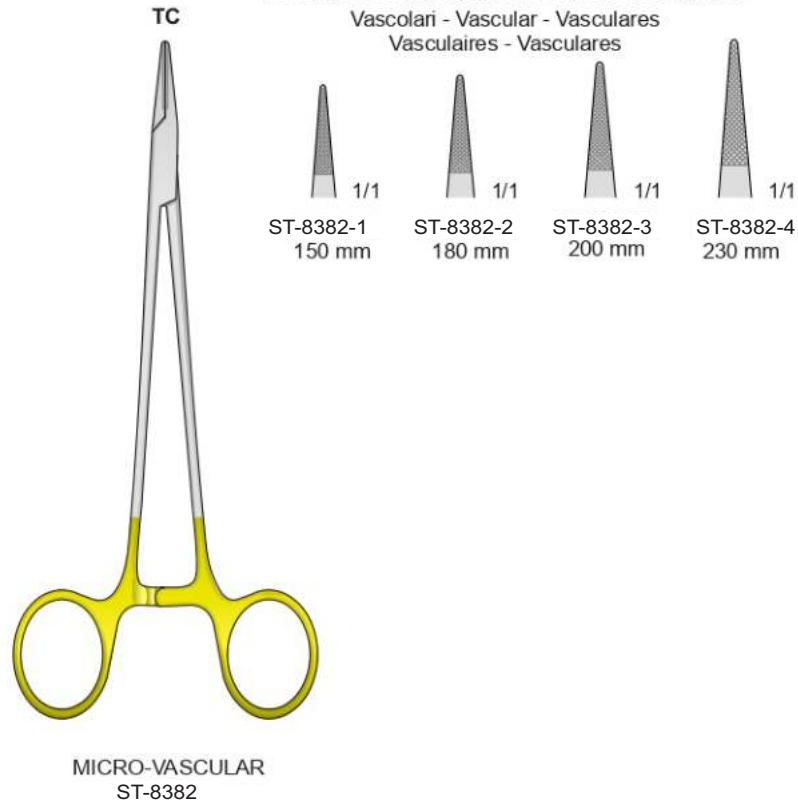
SAROT
ST-8380

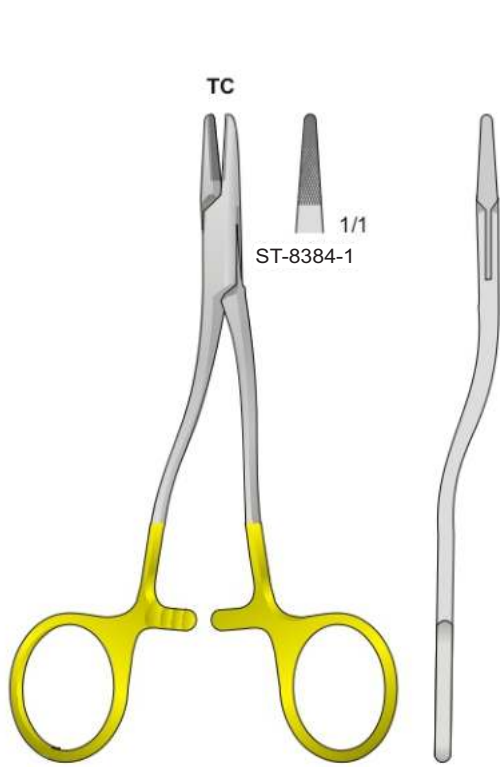


SWEDESH MOD.
ST-8381

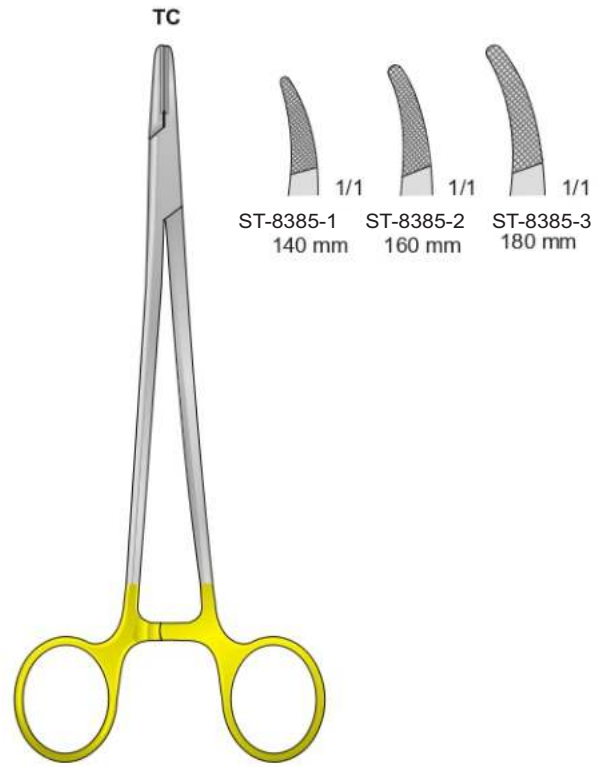


Portaghi con inserti al tungsteno - Needle Holders with tungsten-carbide inserts
Nadelhalter mit Hartmetalleinlagen - Porte aiguilles avec plaquettes en carbure de tungstène
Portaagujas con plaquitas de carburo de tungsteno

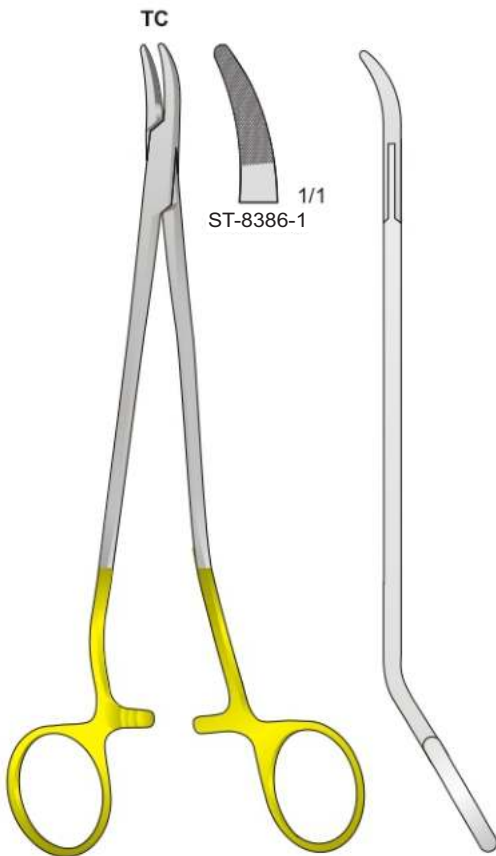




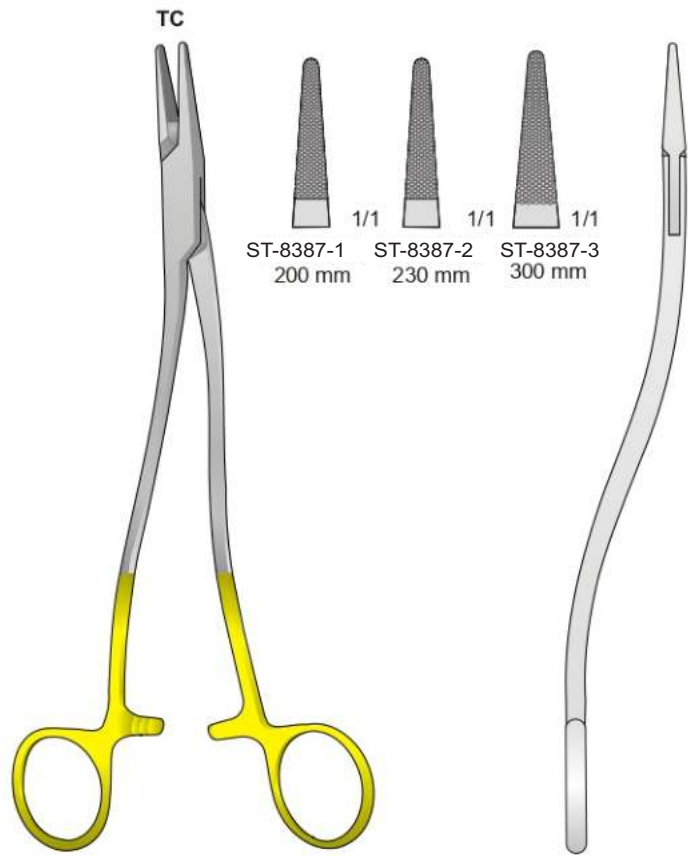
KILNER
ST-8384
130 mm



MAYO-HEGAR-HEANEY
ST-8385



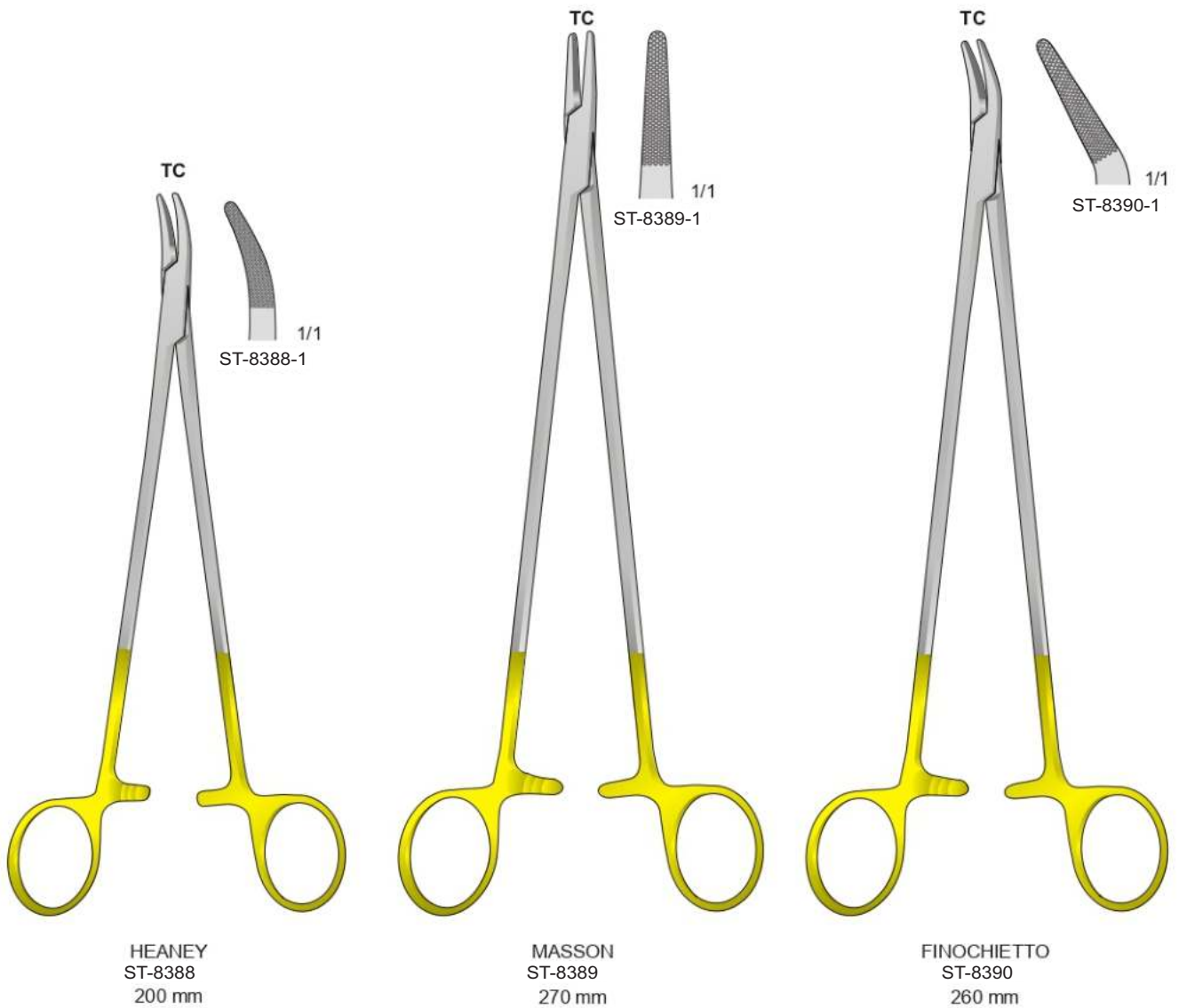
S-FORMING
ST-8386
200 mm



WERTHEIM
ST-8387

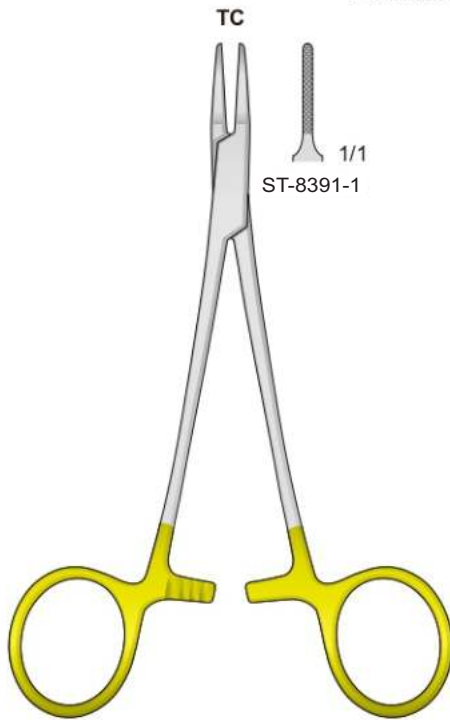


Portaghi con inserti al tungsteno - Needle Holders with tungsten-carbide inserts
 Nadelhalter mit Hartmetalleinlagen - Porte aiguilles avec plaquettes en carbure de tungstène
 Portaagujas con plaquitas de carburo de tungsteno

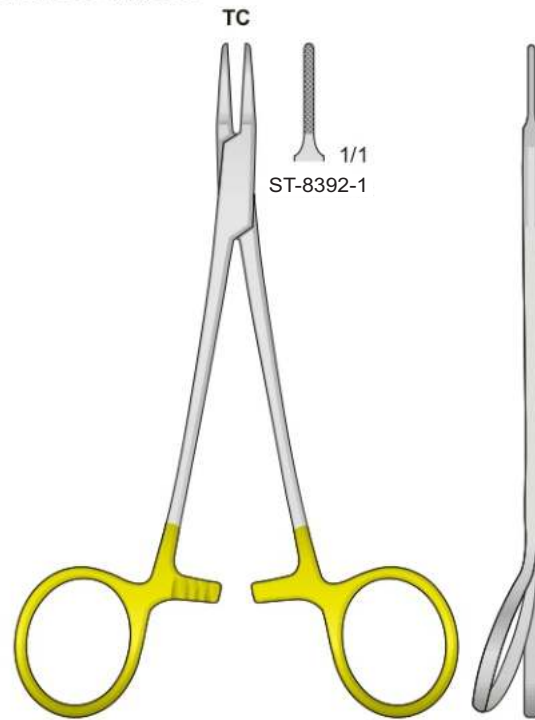




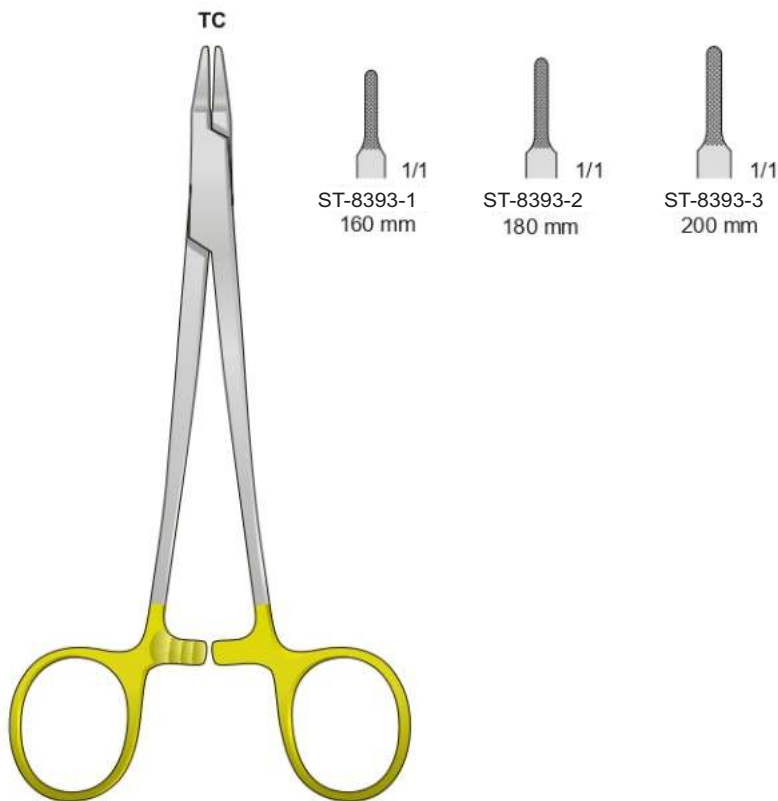
Portaghi con inserti al tungsteno - Needle Holders with tungsten-carbide inserts
Nadelhalter mit Hartmetalleinlagen - Porte aiguilles avec plaquettes en carbure de tungstène
Portaagujas con plaquitas de carburo de tungsteno



MICRO-RYDER
ST-8391
140 mm

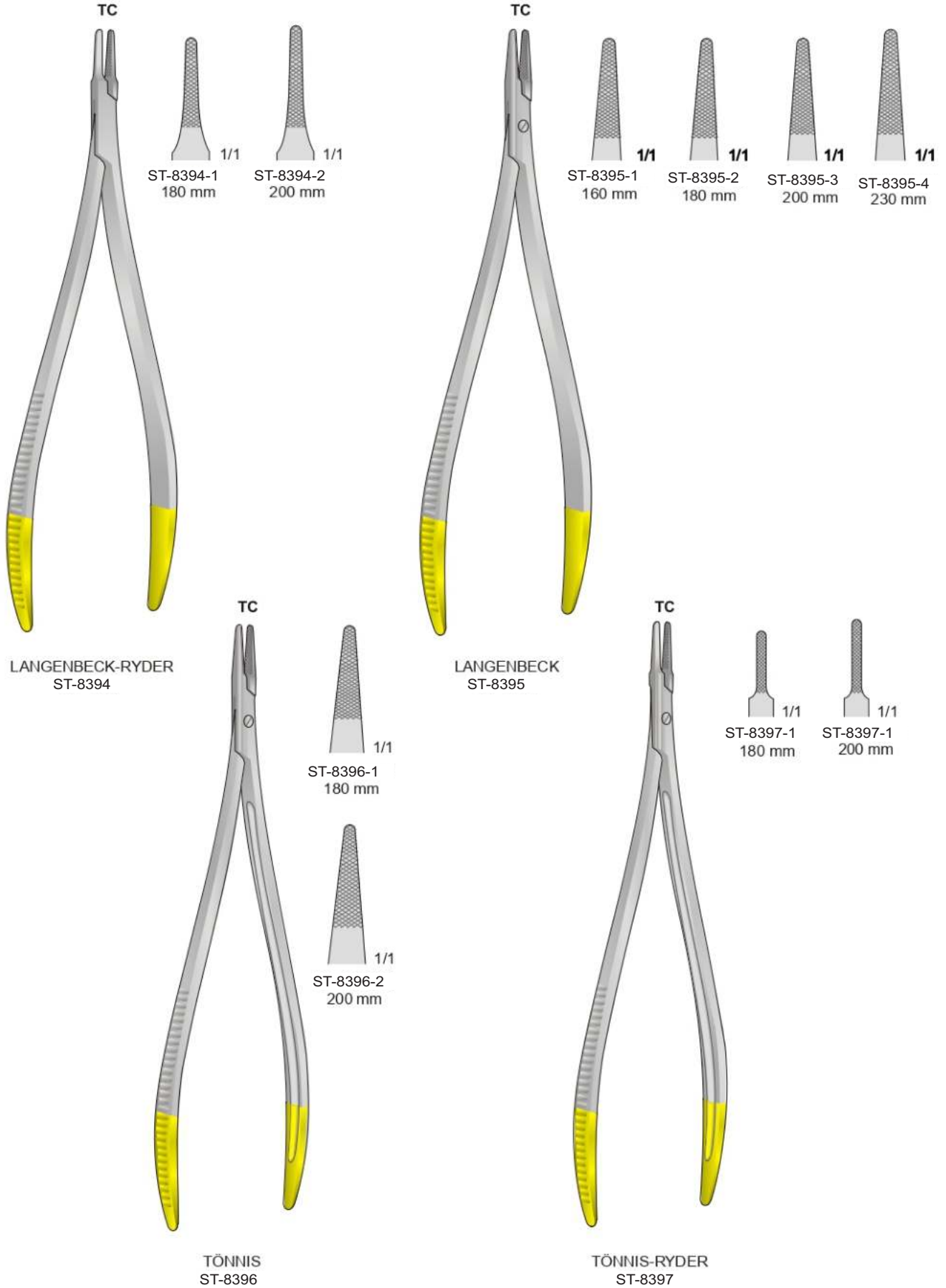


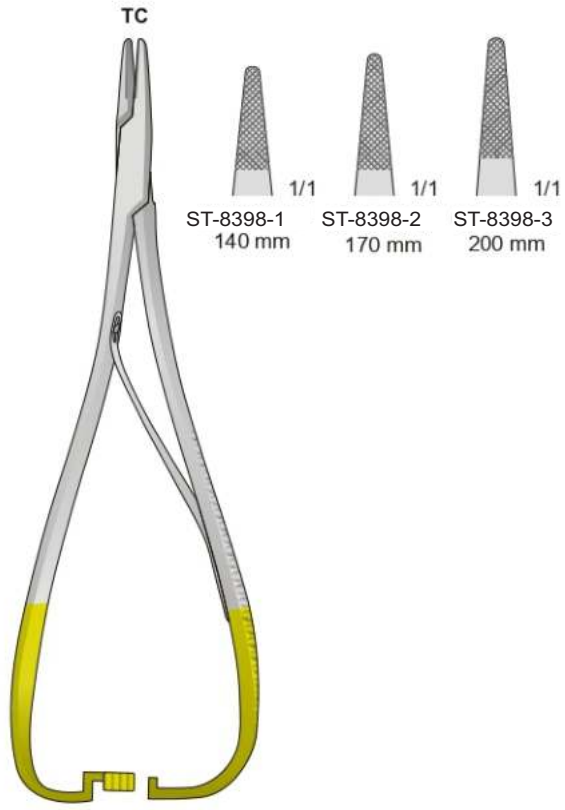
ST-8392
140 mm



RYDER
ST-8393

Portaghi con inserti al tungsteno - Needle Holders with tungsten-carbide inserts
 Nadelhalter mit Hartmetalleinlagen - Porte aiguilles avec plaquettes en carbure de tungstène
 Portaagujas con plaquitas de carburo de tungsteno

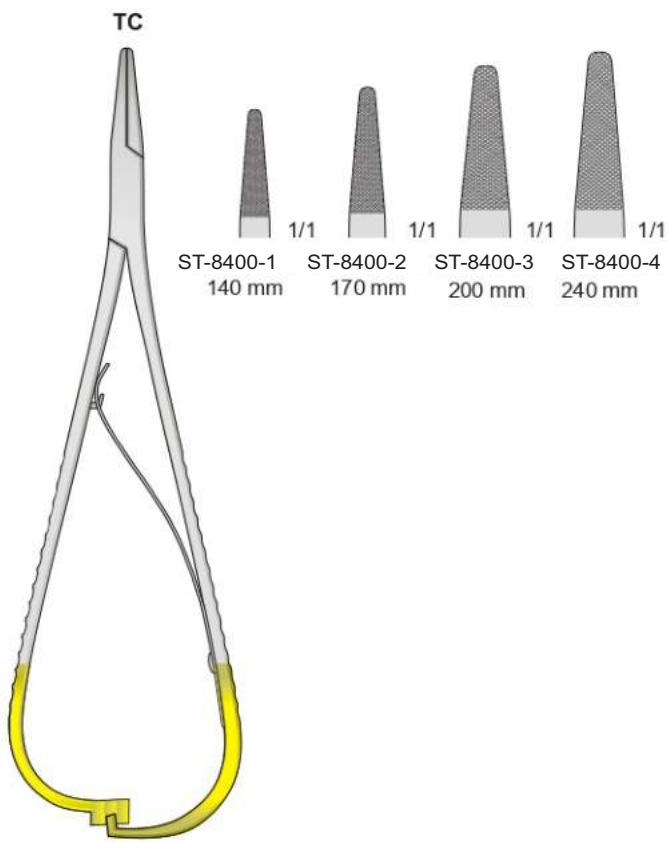




MATHIEU
ST-8398



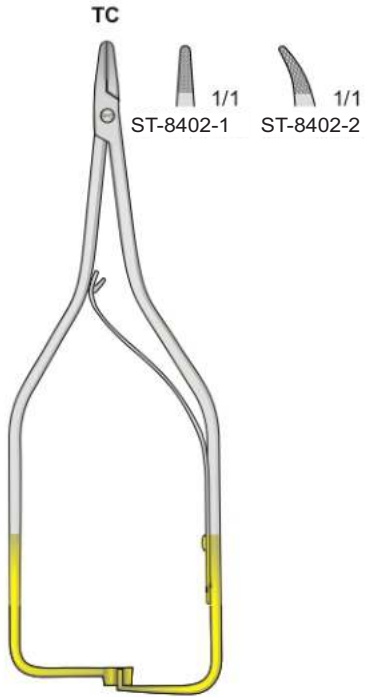
MATHIEU
ST-8399
200 mm



MATHIEU
ST-8400



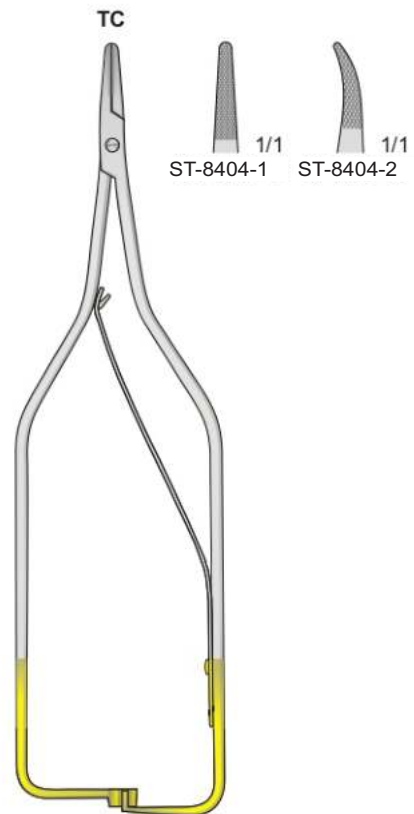
ST-8401
200 mm



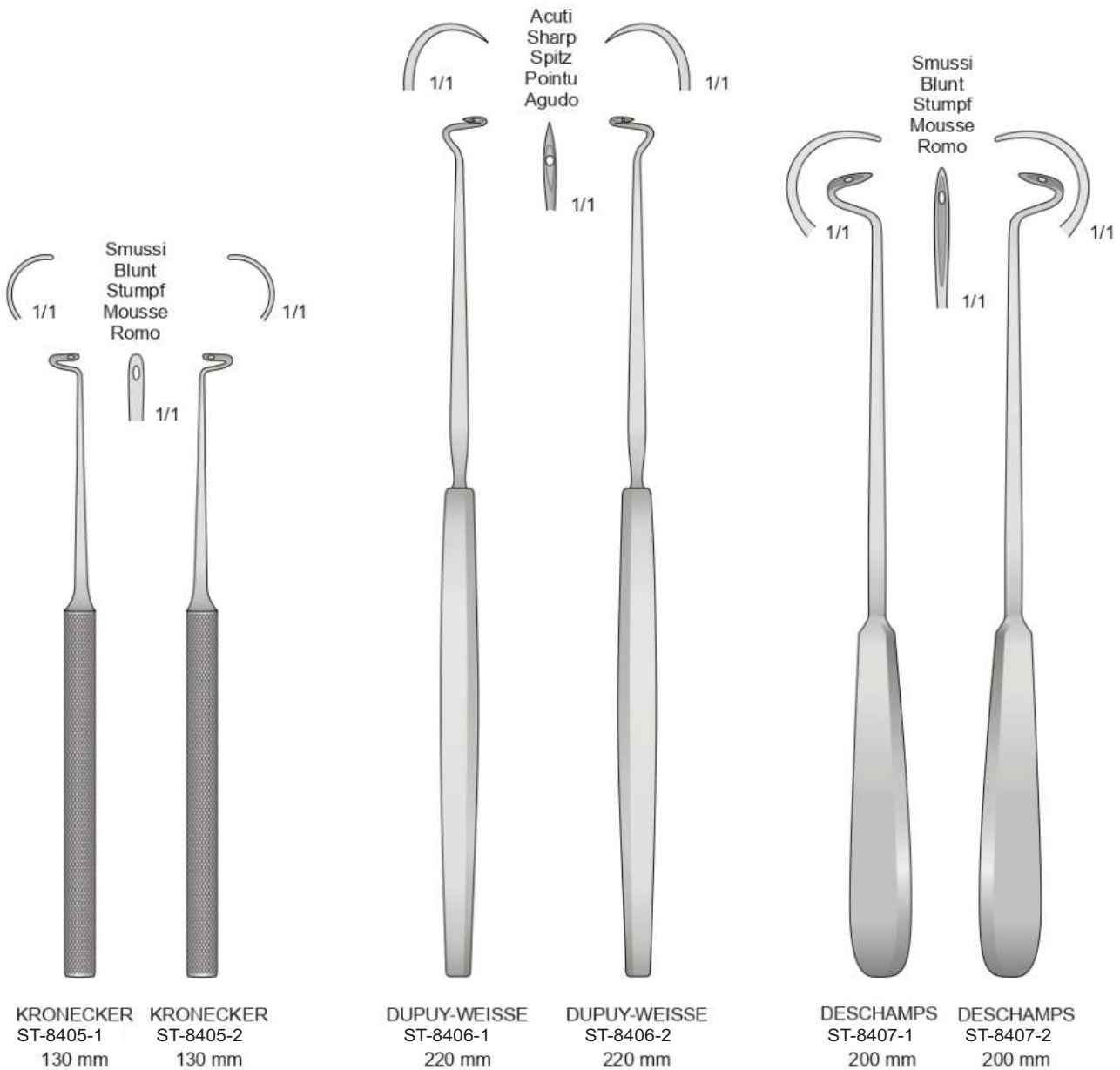
BOYNTON
ST-8402
120 mm



LICHTENBERG
ST-8403
175 mm



ARRUGA
ST-8404
160 mm

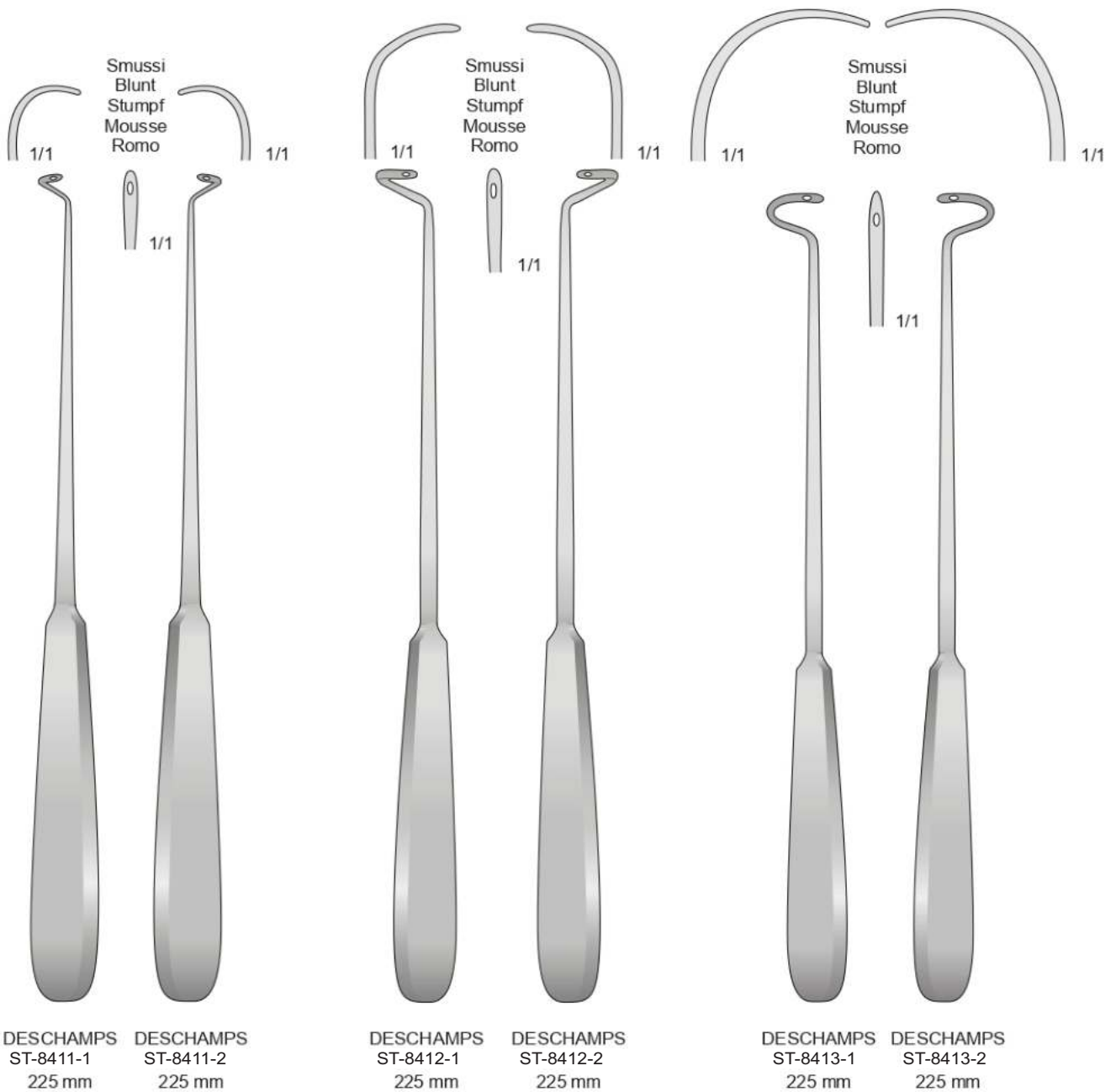


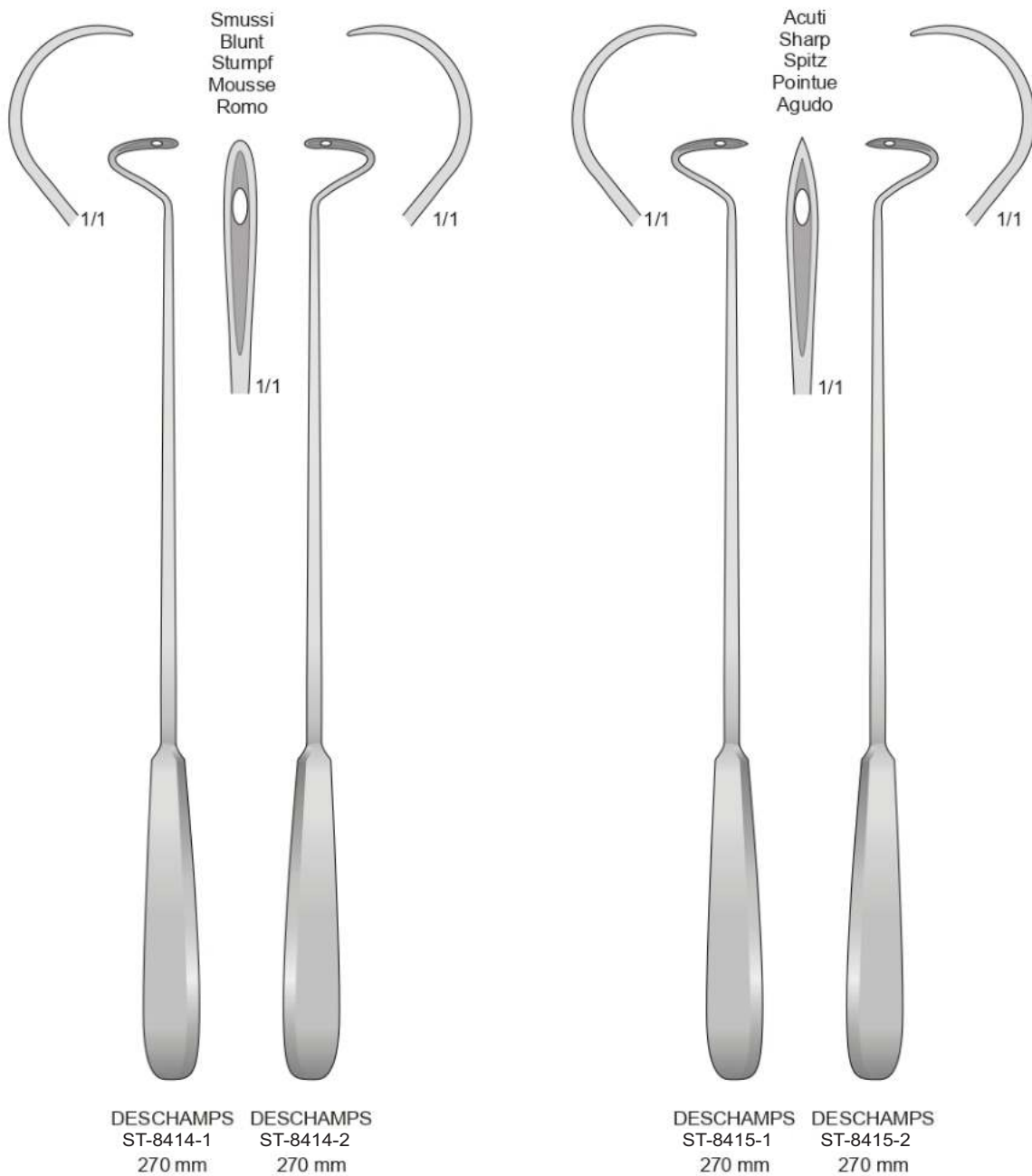


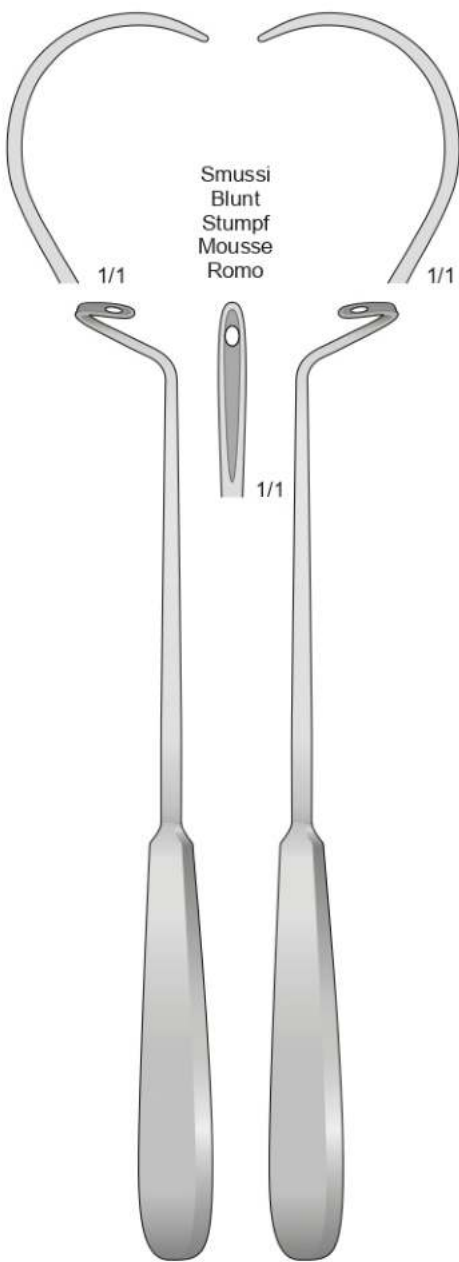
DESCHAMPS ST-8408-1 210 mm
DESCHAMPS ST-8408-2 210 mm

DESCHAMPS ST-8409-1 270 mm
DESCHAMPS ST-8409-2 270 mm

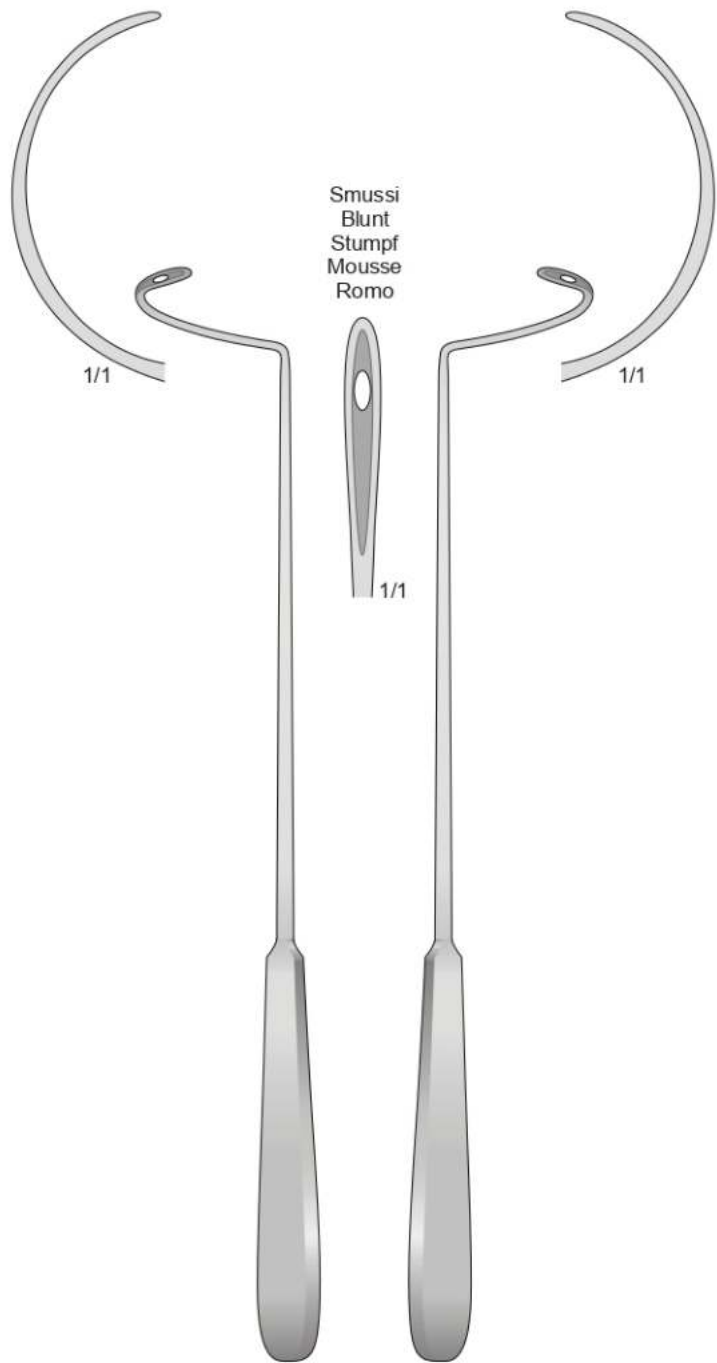
DESCHAMPS ST-8410-1 270 mm
DESCHAMPS ST-8410-2 270 mm



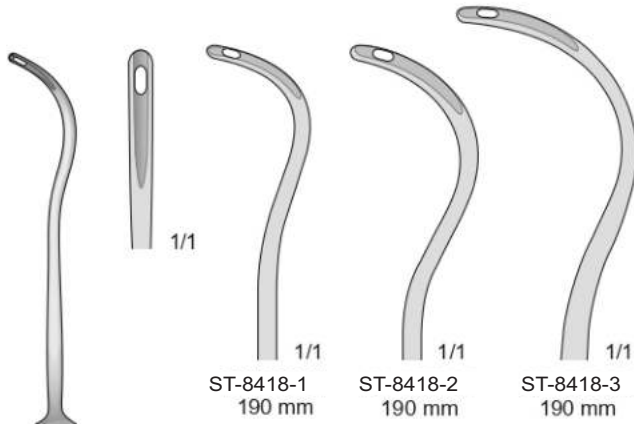




DESCHAMPS DESCHAMPS
ST-8416-1 ST-8416-2
240 mm 240 mm



DESCHAMPS DESCHAMPS
ST-8417-1 ST-8417-2
280 mm 280 mm



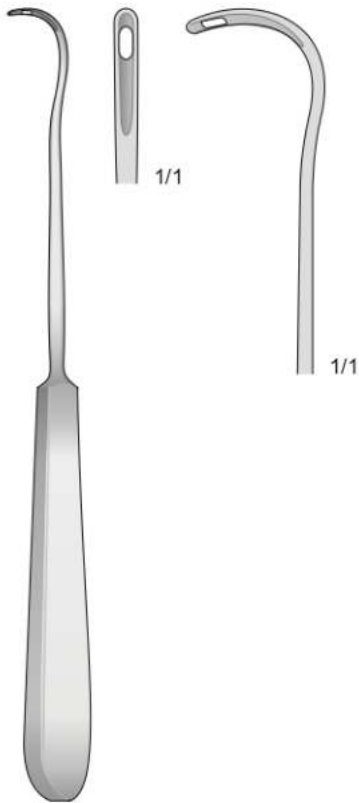
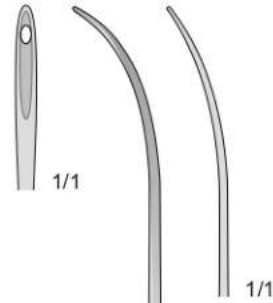
ST-8418-1
190 mm

ST-8418-2
190 mm

ST-8418-3
190 mm

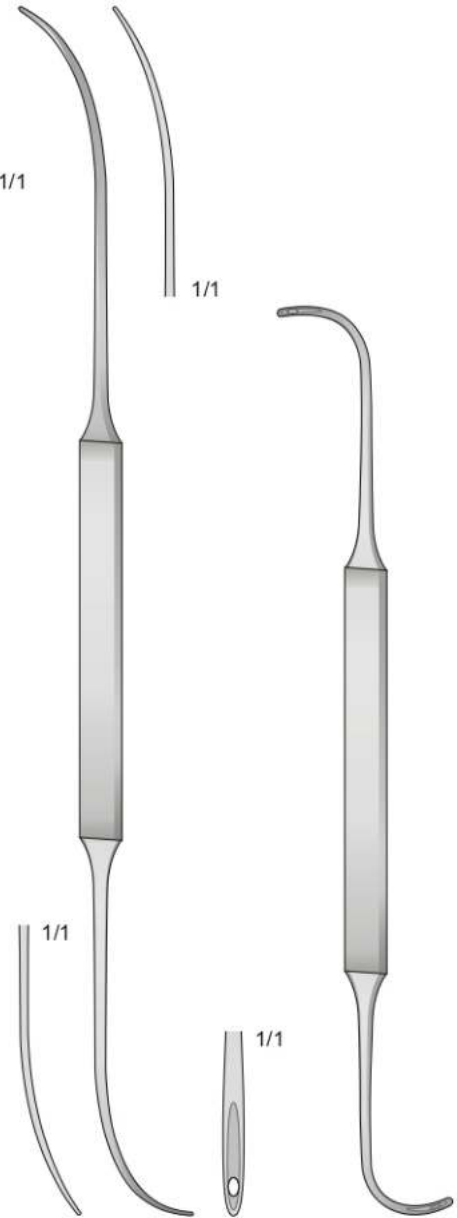
KOCHER
ST-8418
190 mm

Malleable
Flexible
Biegsam
Souple
Maleable



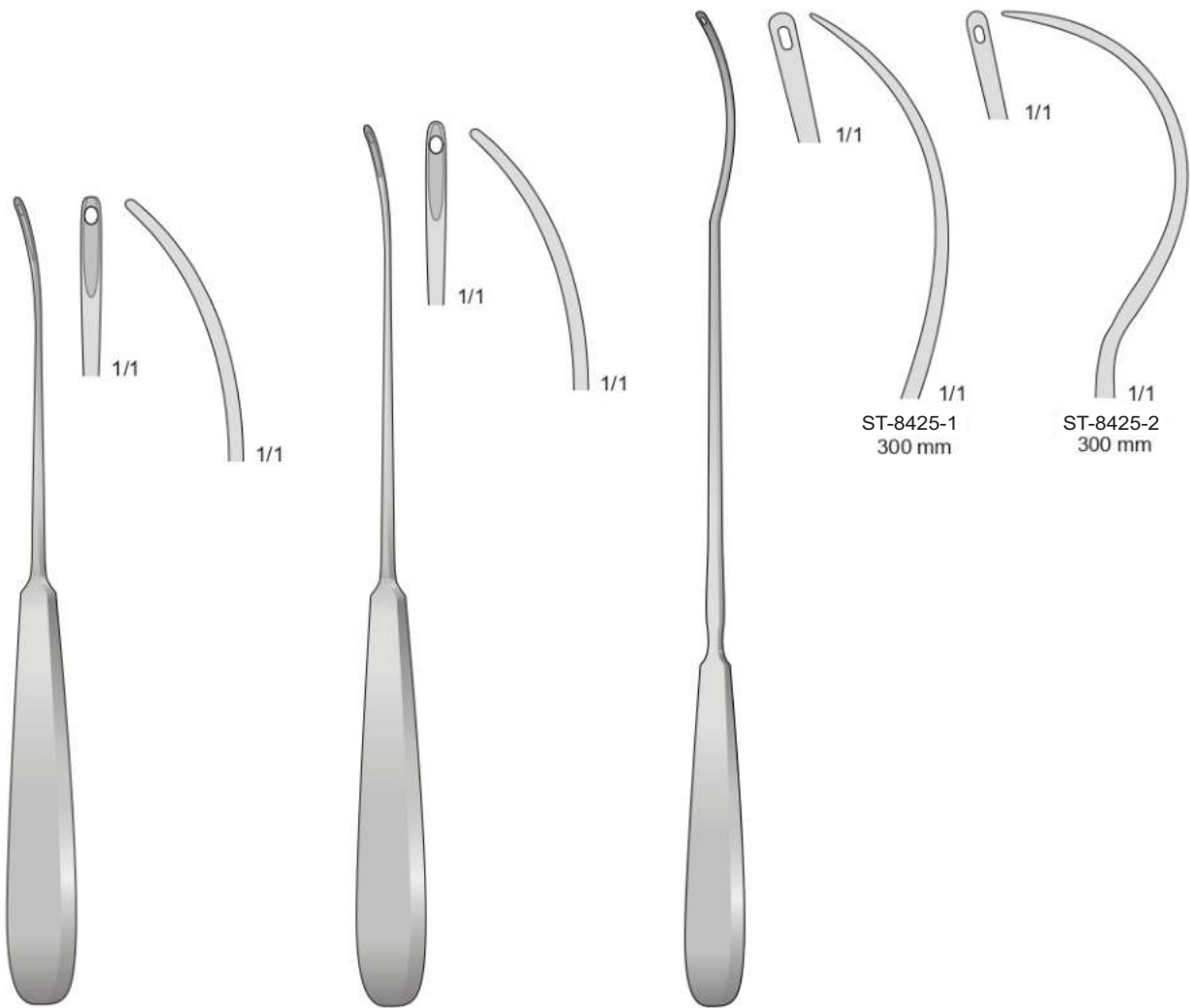
COOPER
ST-8419
200 mm

COOPER
ST-8420
190 mm



SCHMIEDEN-DICK
ST-8421
320 mm

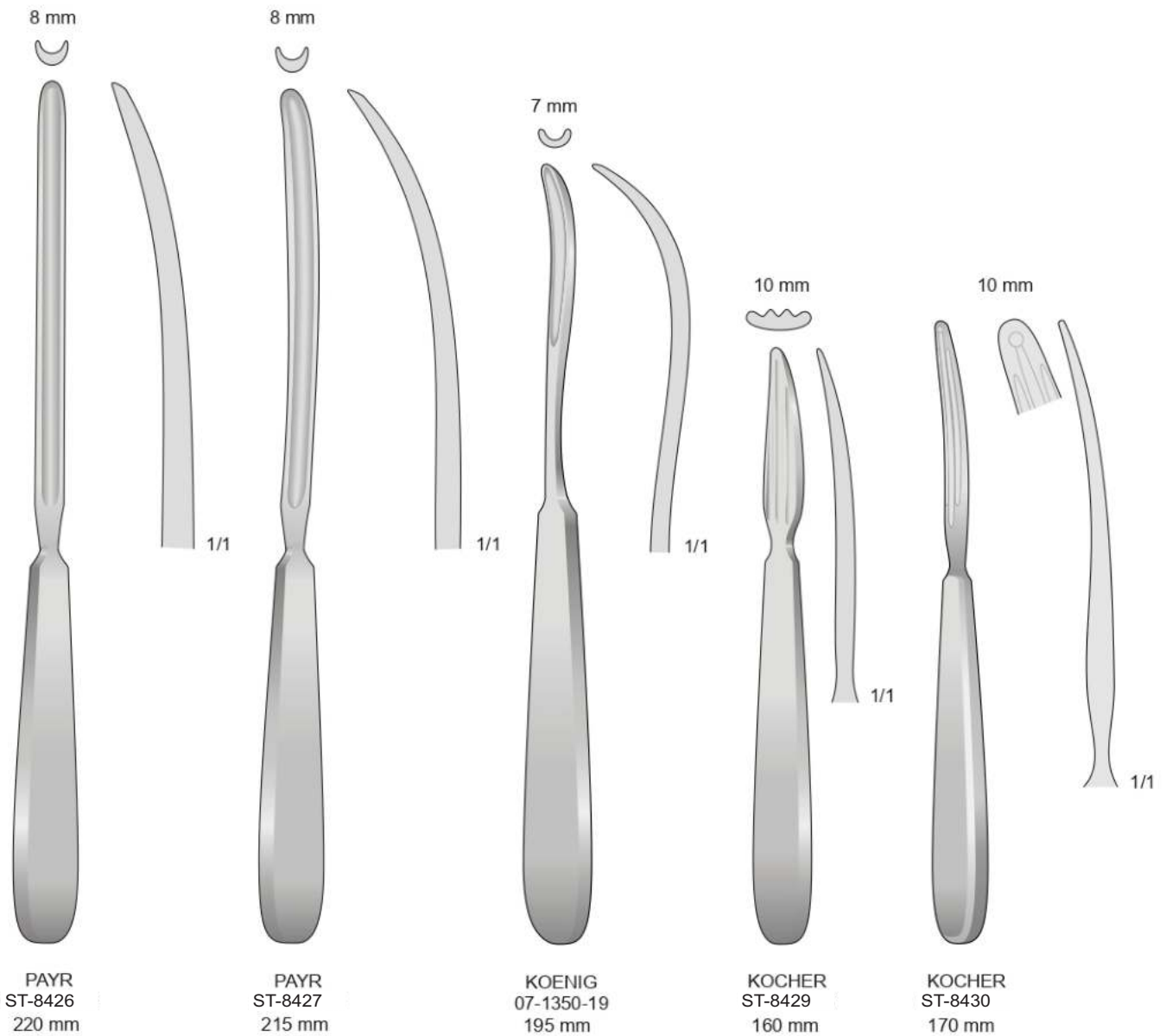
SCHMIEDEN
ST-8422
210 mm



ST-8423
200 mm

ST-8424
230 mm

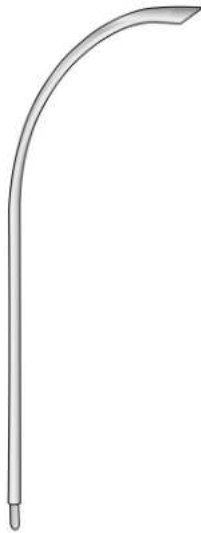
BRUNNER
ST-8425
300 mm



Char. 8	= 2,75 mm
Char 10	= 3,3 mm
Char 12	= 4 mm
Char 14	= 4,6 mm
Char 16	= 5,3 mm
Char 18	= 6 mm



Punta a coltello
Messerspitze gebogen
Knife tip curved



Punta a coltello
Messerspitze gebogen
Knife tip curved



Punta a lancetta
Lanzettenspitze gebogen
Lancet tip curved



Punta Trocar
Dreikantspitze gebogen
Trocar tip curved

Charr.

8 ST-8431-1
10 ST-8431-2
12 ST-8431-3
14 ST-8431-4
16 ST-8431-5
18 ST-8431-6

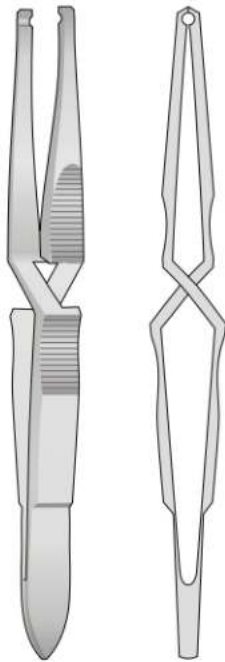
ST-8432-1
ST-8432-2
ST-8432-3
ST-8432-4
ST-8432-5
ST-8432-6

ST-8433-1
ST-8433-2
ST-8433-3
ST-8433-4
ST-8433-5
ST-8433-6

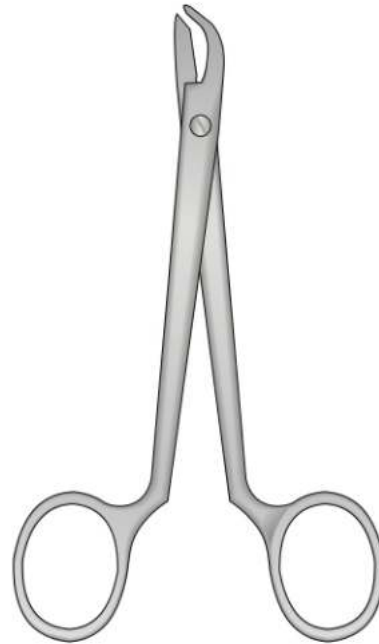
ST-8434-1
ST-8434-2
ST-8434-3
ST-8434-4
ST-8434-5
ST-8434-6



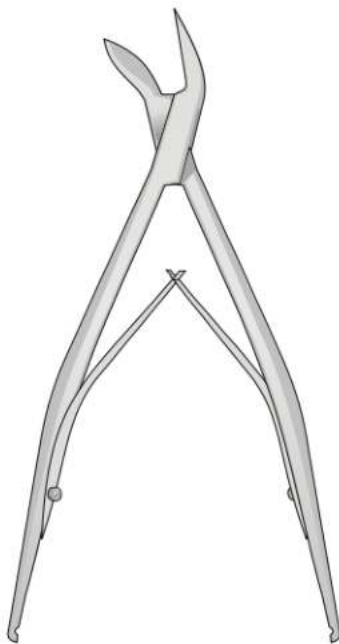
1/1



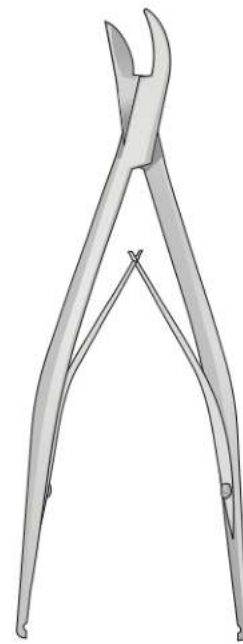
HEGENBARTH
ST-8435
125 mm



COLLIN
ST-8436
135 mm



MICHEL
ST-8437
130 mm

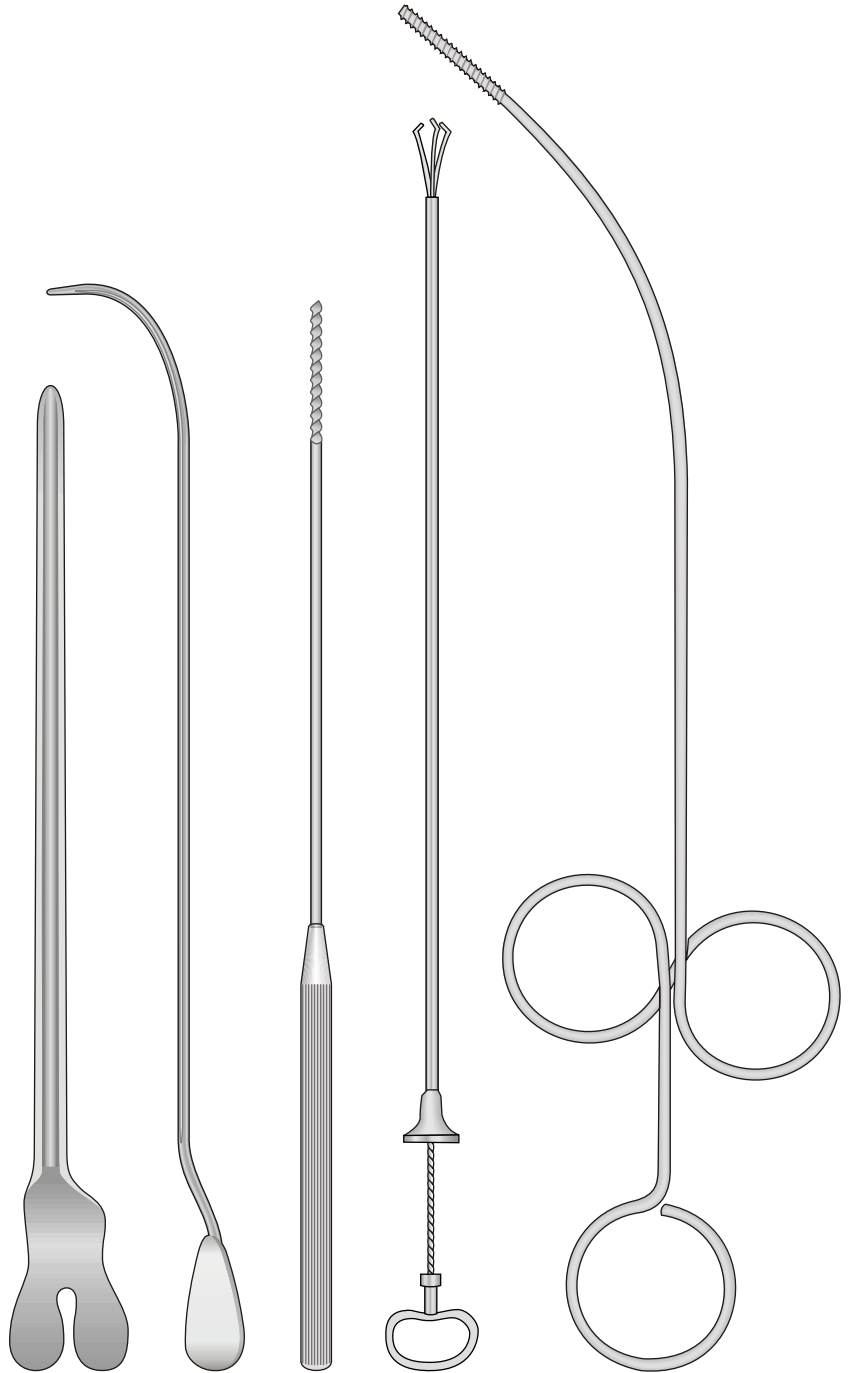


MICHEL
ST-8438
120 mm

Probes, Cotton Applicator



SAFE TOOL
MANUFACTURER & EXPORTER

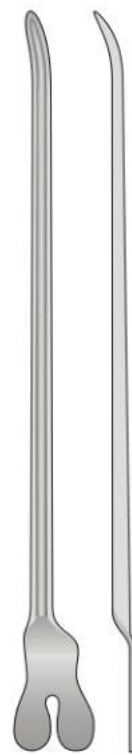
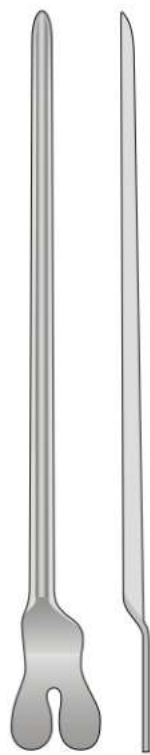
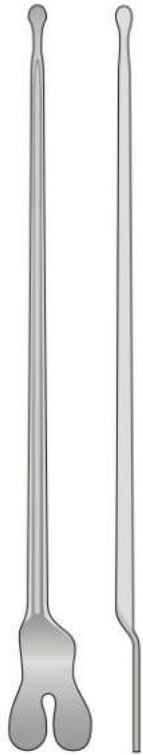


www.safetool.com.pk

*Surgical
Instruments*



Hohlsonde



ST-9001-1 145 mm
ST-9001-2 160 mm
ST-9001-3 180 mm
ST-9001-4 200 mm

ST-9002-1 130 mm
ST-9002-2 145 mm
ST-9002-3 160 mm
ST-9002-4 180 mm
ST-9002-5 200 mm

DOYEN
ST-9003
145 mm

NELATON
ST-9004
160 mm

Sonde per fistole - Fistula probes - Fistelsonden - Sondes pour fistulas - Sondas para fistulas



LOCHART
ST-9005
170 mm

LOCHART
ST-9006
170 mm

LOCHART
ST-9007
170 mm

LOCHART
ST-9008
170 mm

LOCHART
ST-9009
190 mm

1/1
Malleabile
Malleable
Biegsam
Maleable



Ø 1 mm



Ø 1,5 mm



Ø 2 mm



Ø 2 mm



Ø 1,5 mm



Ø 1,0 mm

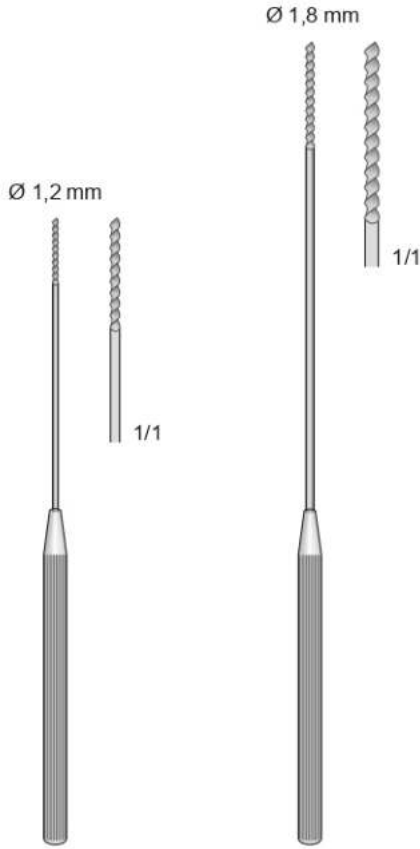


ST-9010-1	145 mm	ST-9011-1	130 mm	ST-9012-1	145 mm	ST-9013-1	130 mm
ST-9010-2	160 mm	ST-9011-2	145 mm	ST-9012-2	160 mm	ST-9013-2	145 mm
		ST-9011-3	160 mm	ST-9012-3	200 mm	ST-9013-3	160 mm
		ST-9011-4	200 mm	ST-9012-4	250 mm	ST-9013-4	200 mm

ST-9014
145 mm

STACKE
ST-9015
110 mm

BOWMAN			
ST-9016-1	00/0	ST-9016-4	5/6
ST-9016-2	1/2	ST-9016-5	7/8
ST-9016-3	3/4	ST-9016-6	6/7



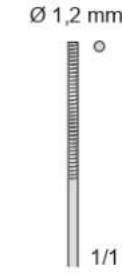
UNIVERSAL
 ST-9017-1 120 mm
 ST-9017-1 140 mm
 ST-9017-1 160 mm



UNIVERSAL
 ST-9018-1 120 mm
 ST-9018-1 140 mm
 ST-9018-1 160 mm
 ST-9018-1 180 mm



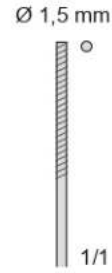
MOD. MARTIN
 ST-9020



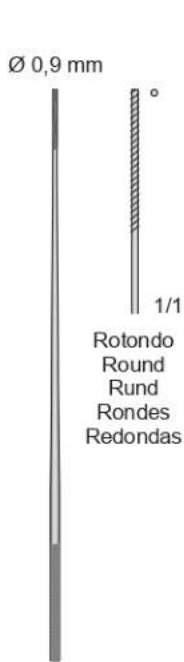
ST-9020-1 140 mm
 ST-9020-4 160 mm
 Rotondo
 Round
 Rund
 Rondes
 Redondas



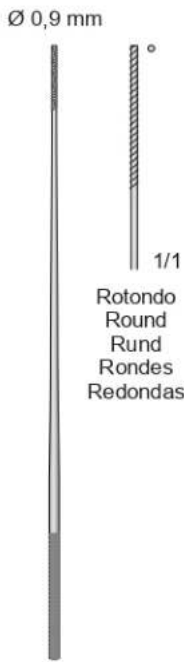
ST-9020-2 140 mm
 ST-9020-5 160 mm
 Triangolare
 Triangular
 Dreikant
 Triangulaires
 Triangulares



ST-9020-3 180 mm
 Rotondo
 Round
 Rund
 Rondes
 Redondas



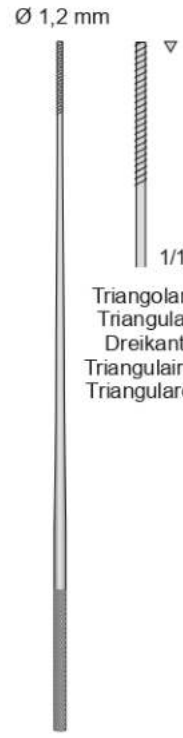
FARRELL
 ST-9021 120 mm



FARRELL
 ST-9022-1 140 mm
 ST-9022-2 160 mm
 ST-9022-3 180 mm



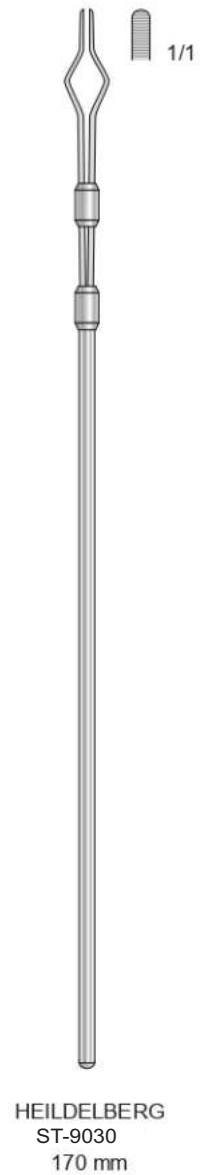
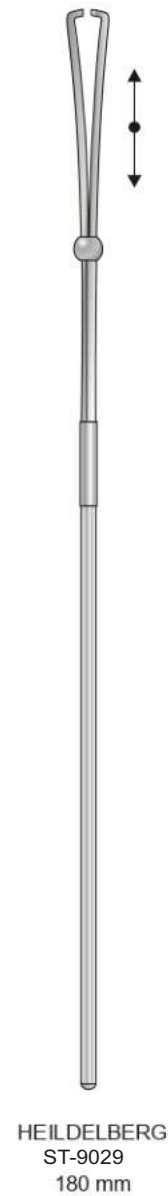
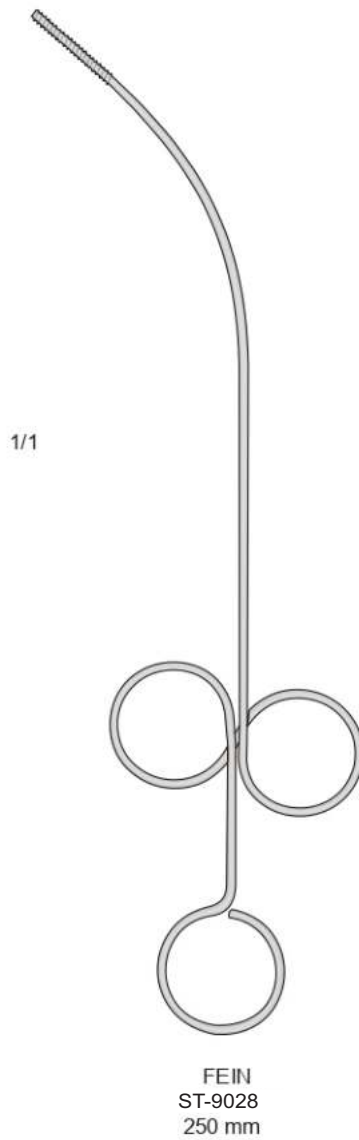
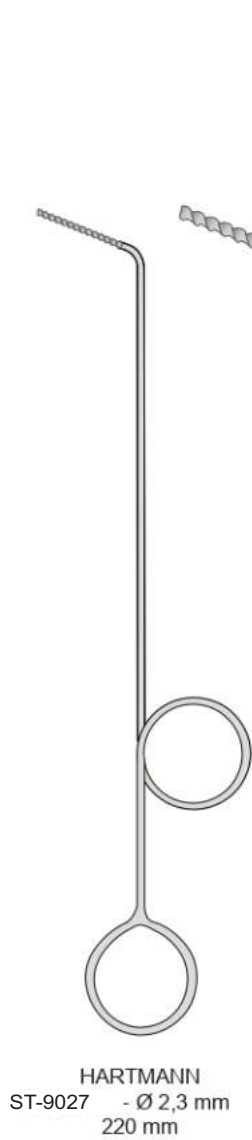
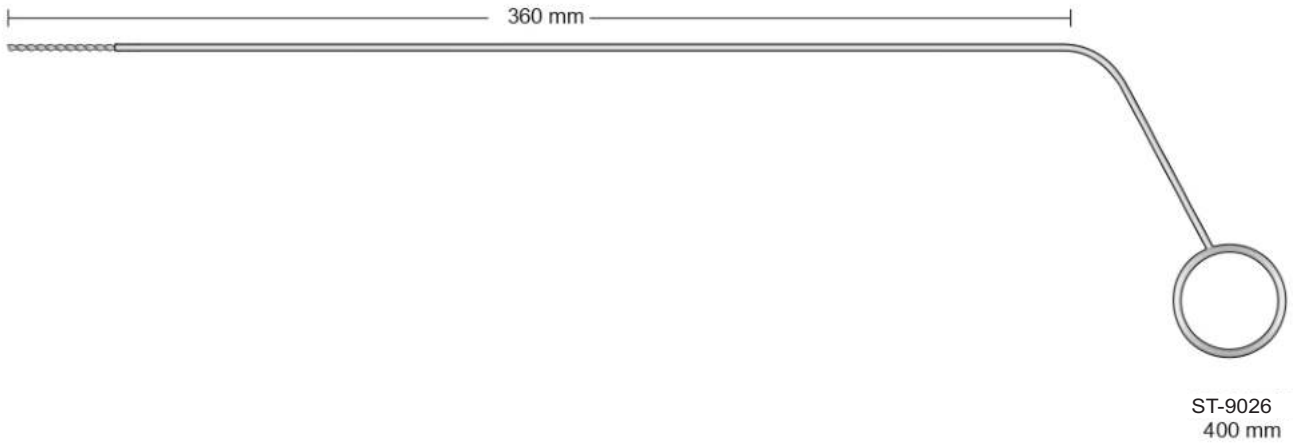
FARRELL
 ST-9023-1 140 mm
 ST-9023-2 160 mm

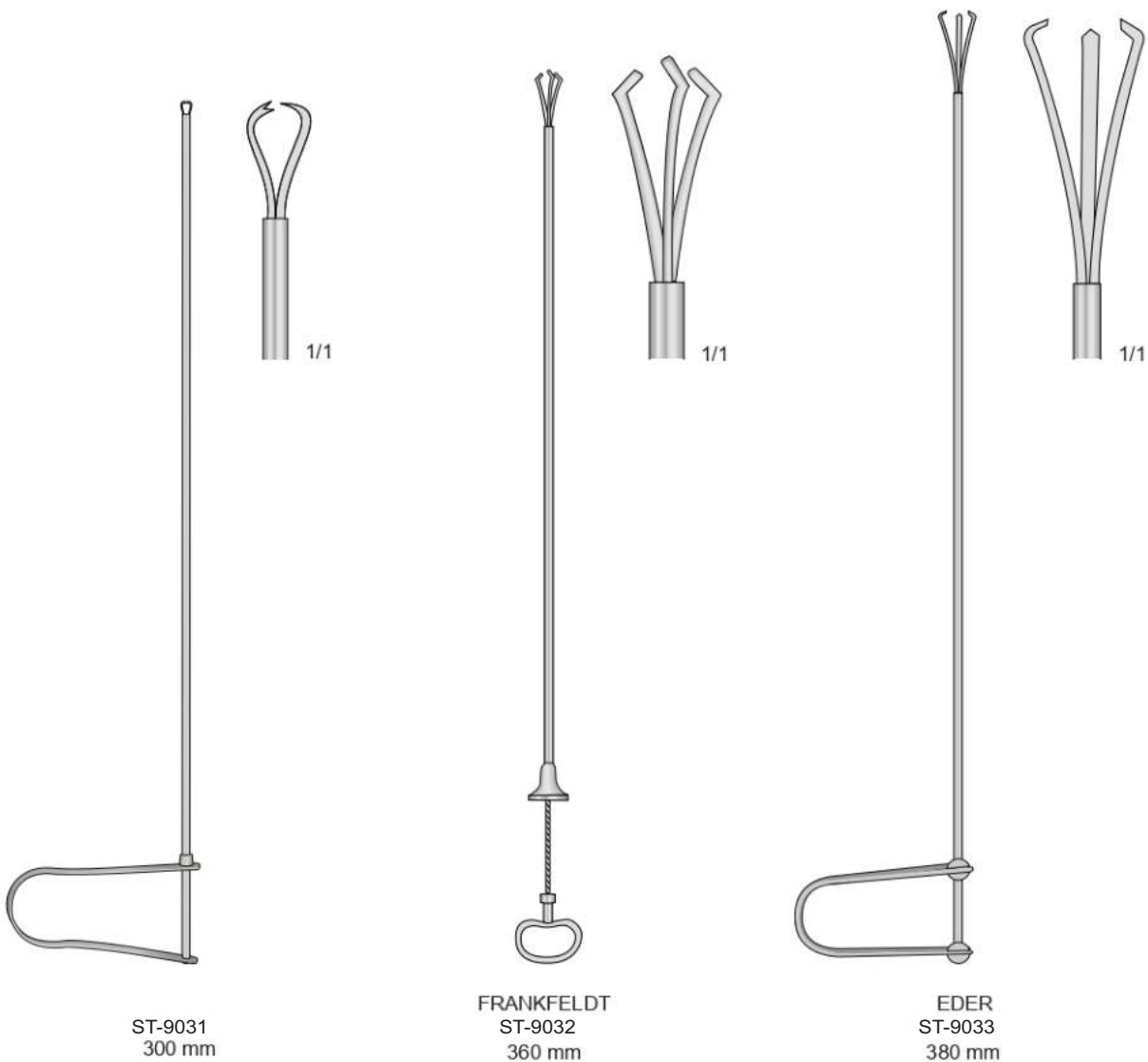


FARRELL
 ST-9024 180 mm



FARRELL
 ST-9025 230 mm

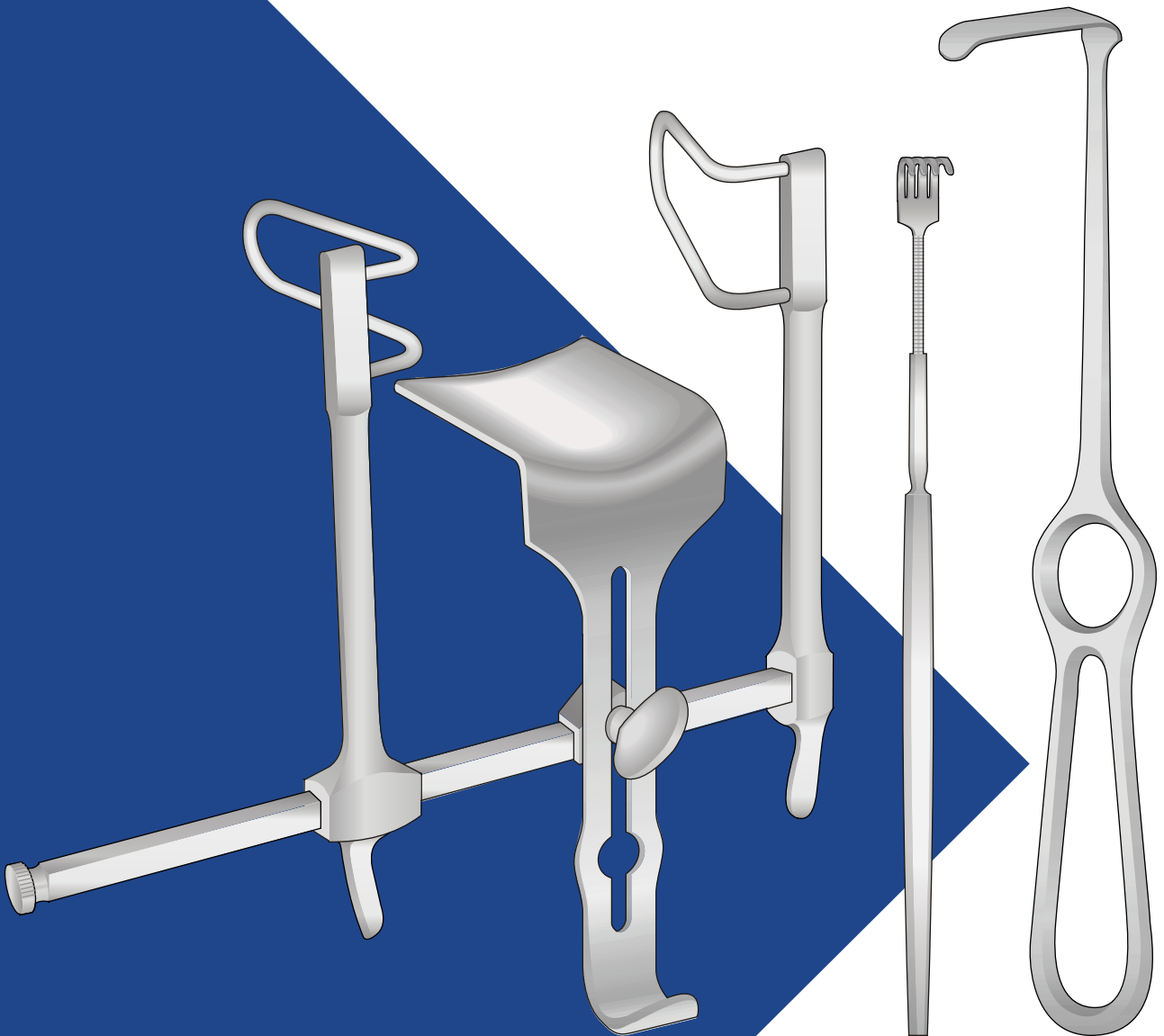






SAFE TOOL
MANUFACTURER & EXPORTER

Retractors

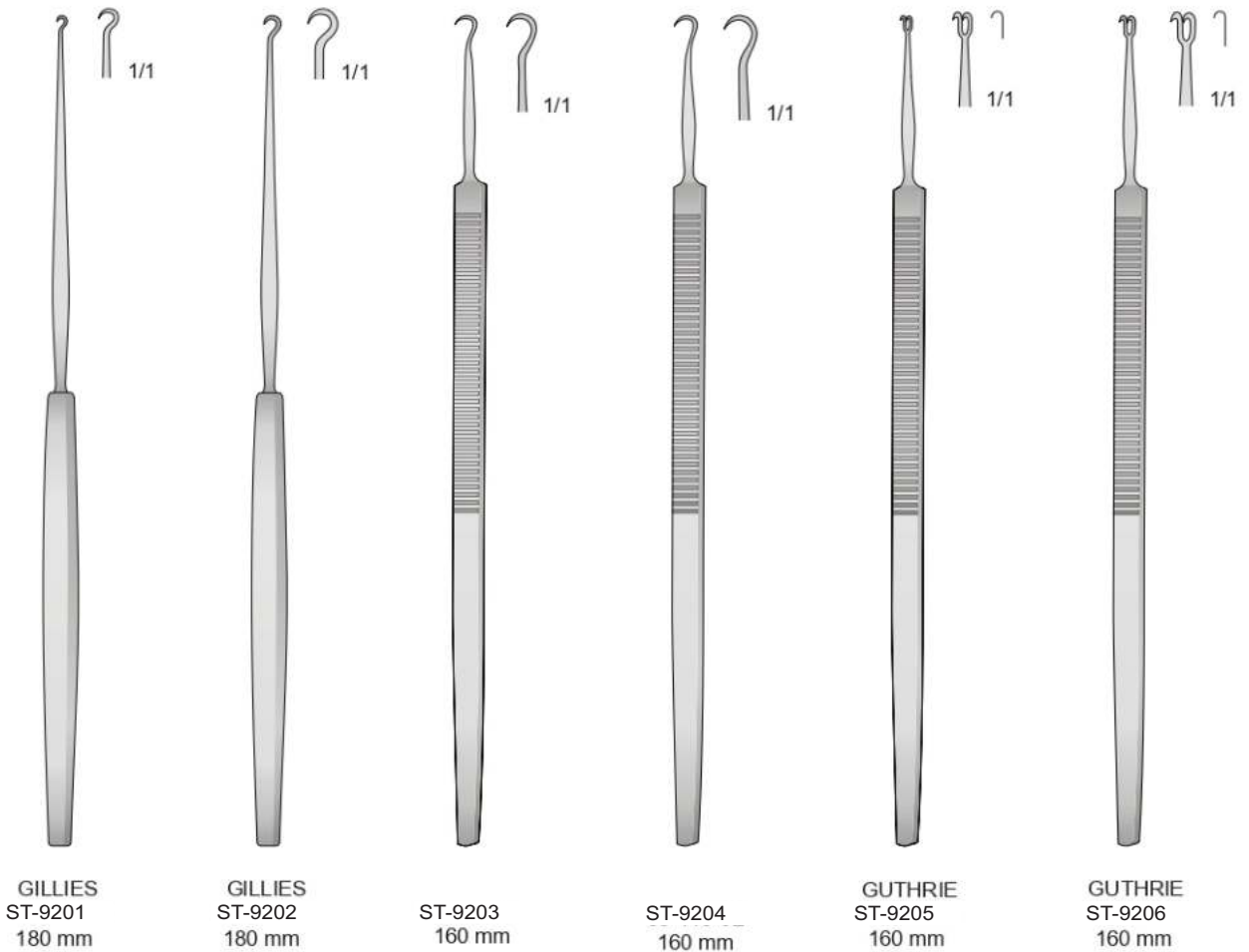


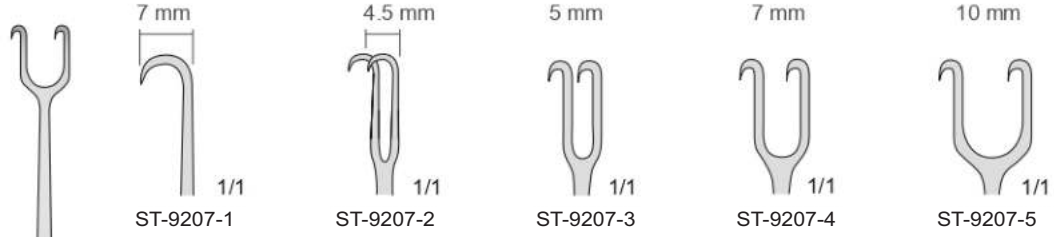
www.safetool.com.pk

***SURGICAL
INSTRUMENTS***

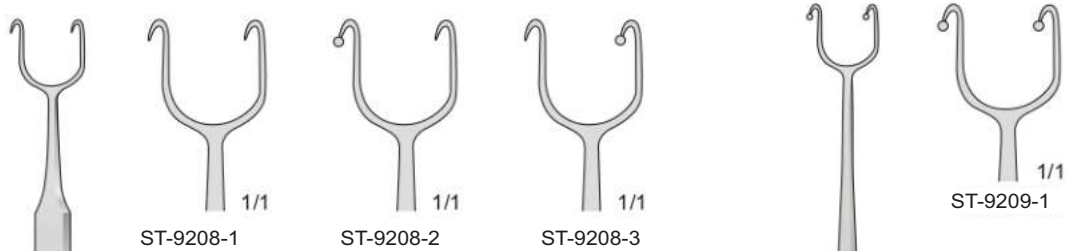


Uncini cutanei - Cutaneous hook - Hauthäkchen - Erignes cutanées - Ganchos cutáneos





JOSEPH
ST-9207
160 mm



COTTLE
ST-9208
150 mm

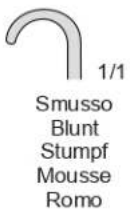
FOMON
ST-9209
160 mm



ST-9210
160 mm



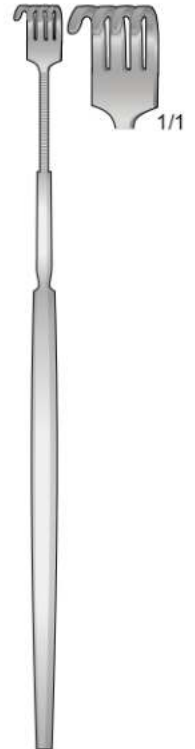
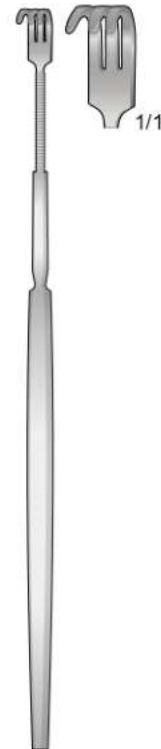
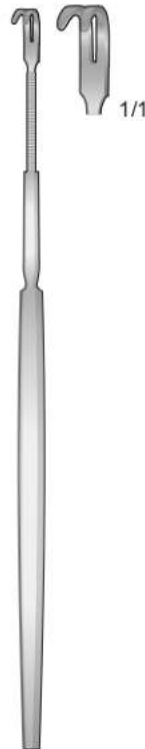
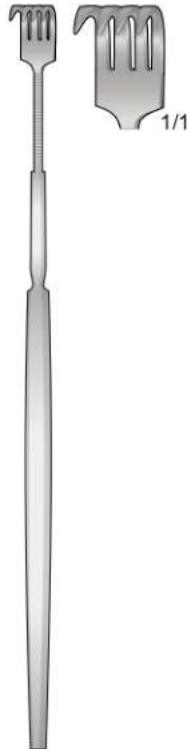
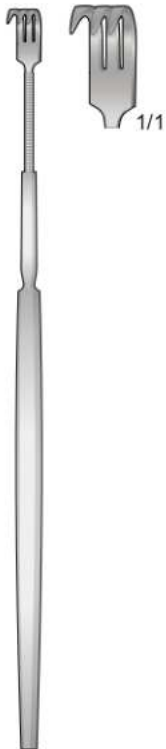
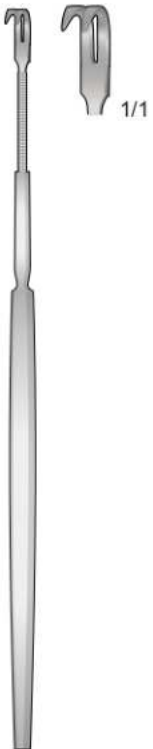
ST-9211
160 mm





Divaricatori delicati flessibili-acuti
Feine wundhaken flexibel-spitz
Delicate retractors flexible-sharp
Separadores finos flexibles-agudas

Divaricatori delicati flessibili-smussi
Feine wundhaken flexibel-stumpf
Delicate retractors flexible-blunt
Separadores finos flexibles-romas



ST-9212
150 mm

ST-9212
150 mm

ST-9213
150 mm

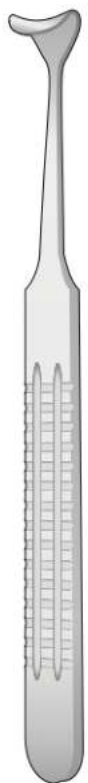
ST-9214
150 mm

ST-9215
150 mm

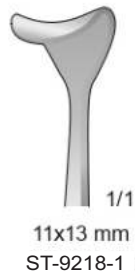
ST-9216
150 mm



DESMARRES
ST-9217
140 mm



DESMARRES
ST-9218
160 mm

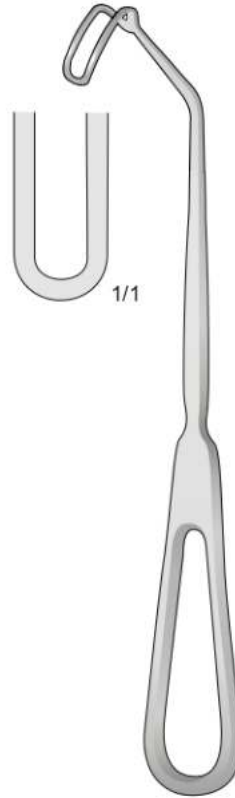


SENN GREEN
ST-9219
160 mm

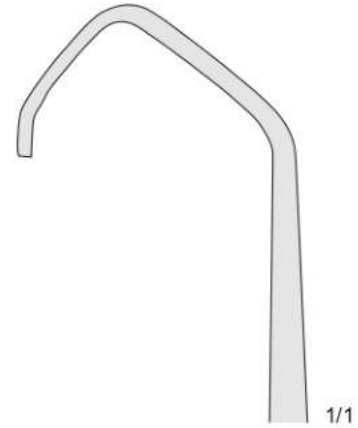




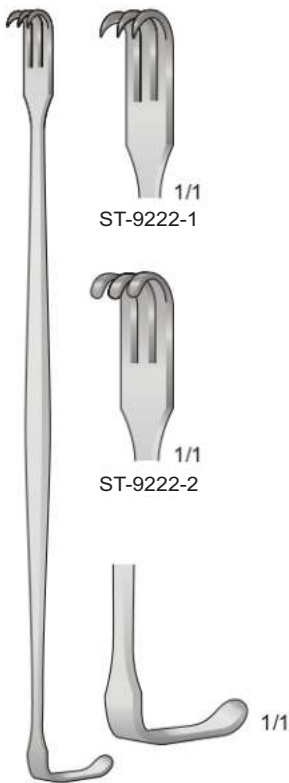
LAHEY
ST-9220
195 mm



CUSHING
ST-9221
200 mm



1/1

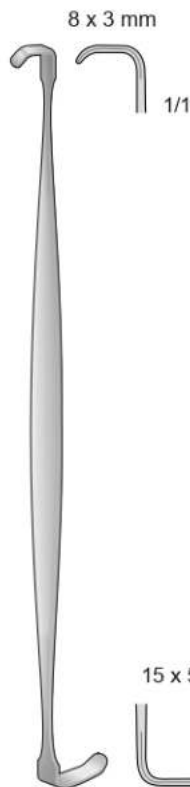


SENN-MILLER
ST-9222
160 mm

ST-9222-1
1/1

ST-9222-2
1/1

1/1



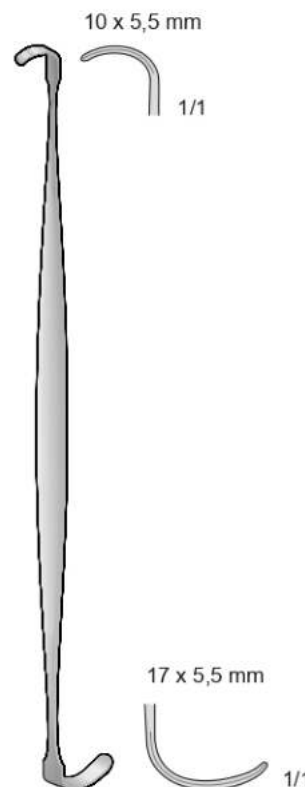
RAGNELL
ST-9223
140 mm

8 x 3 mm

1/1

15 x 5 mm

1/1



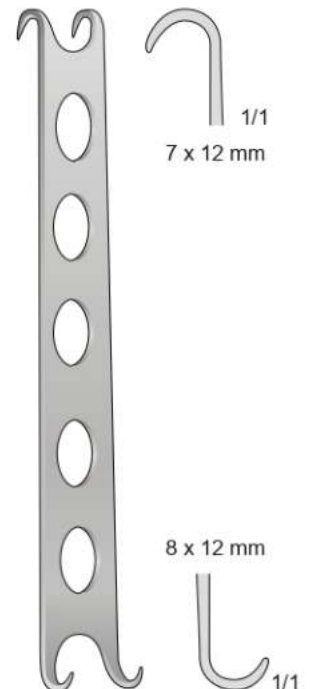
RAGNELL-DAVIS
ST-9224
140 mm

10 x 5,5 mm

1/1

17 x 5,5 mm

1/1

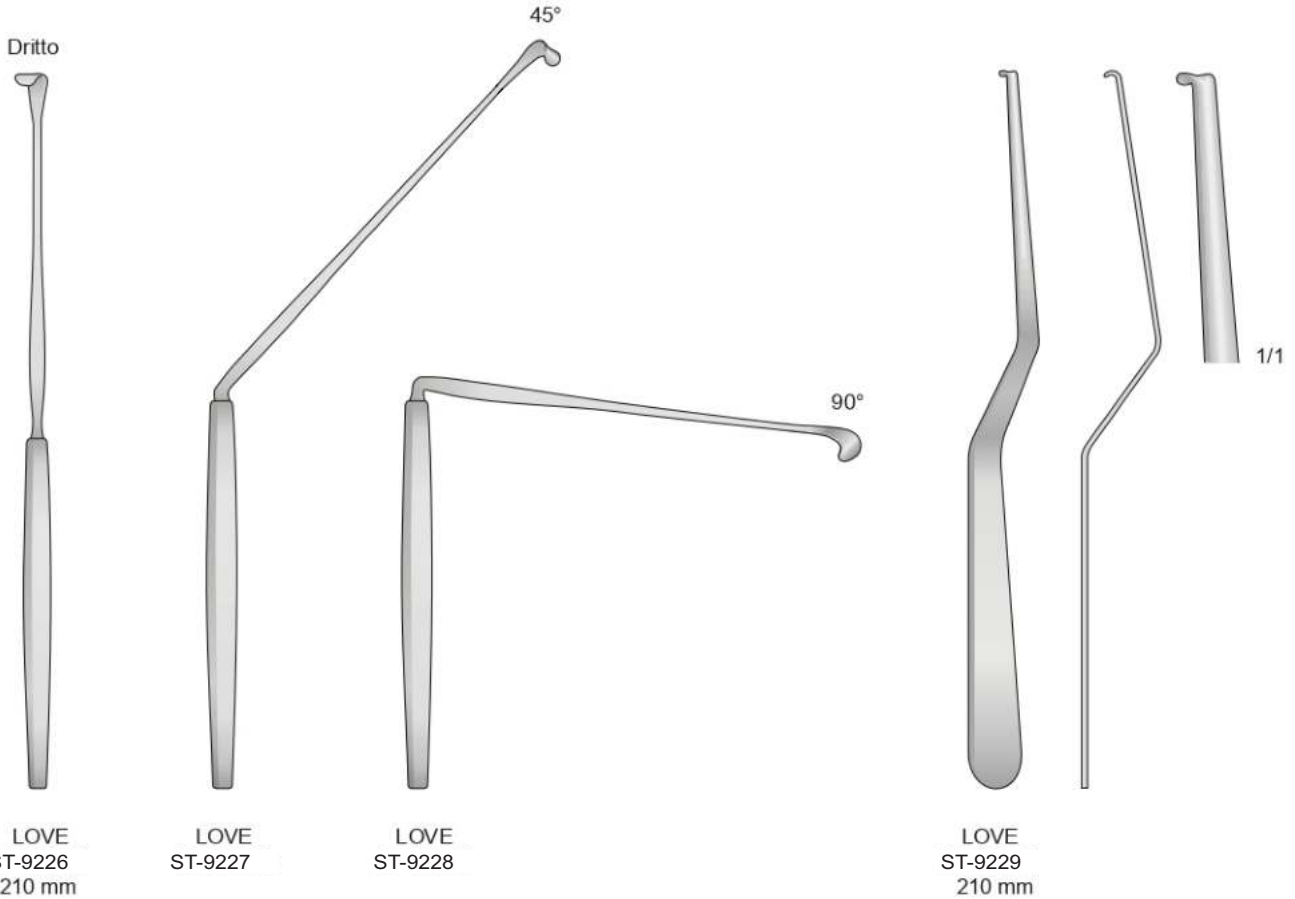


CONVERSE
ST-9225
120 mm

7 x 12 mm
1/1

8 x 12 mm

1/1

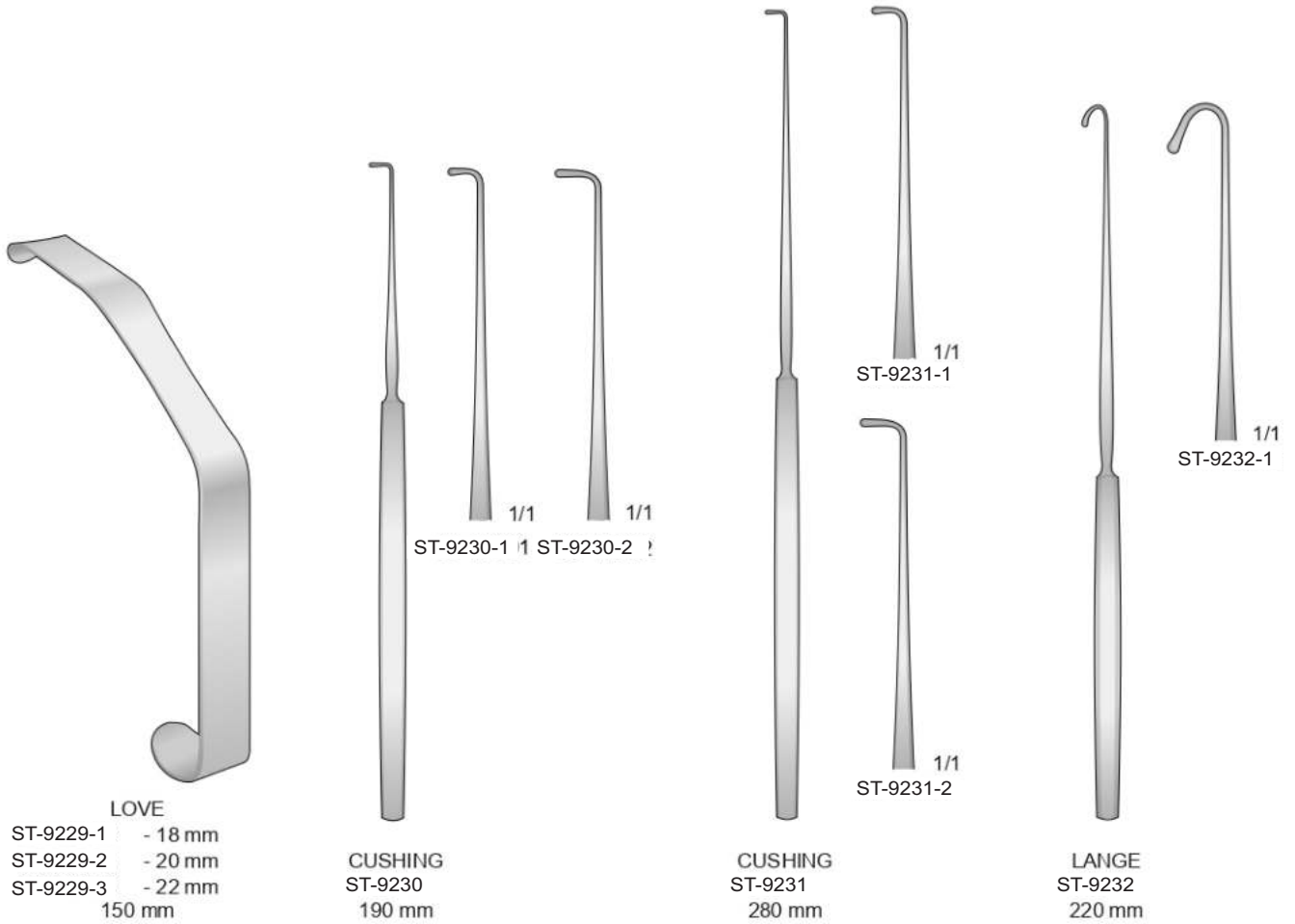


LOVE
ST-9226
210 mm

LOVE
ST-9227

LOVE
ST-9228

LOVE
ST-9229
210 mm



LOVE
ST-9229-1 - 18 mm
ST-9229-2 - 20 mm
ST-9229-3 - 22 mm
150 mm

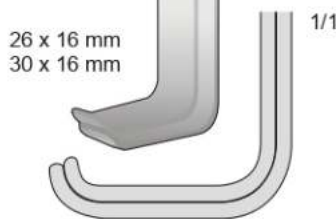
CUSHING
ST-9230
190 mm

CUSHING
ST-9231
280 mm

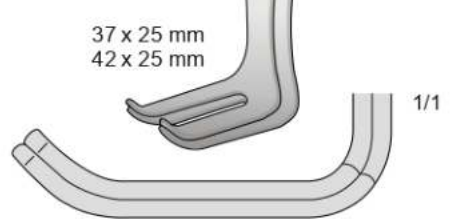
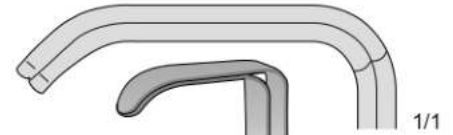
LANGE
ST-9232
220 mm



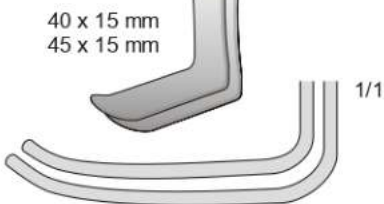
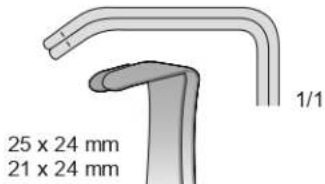
FARABEUF
ST-9233
120 mm



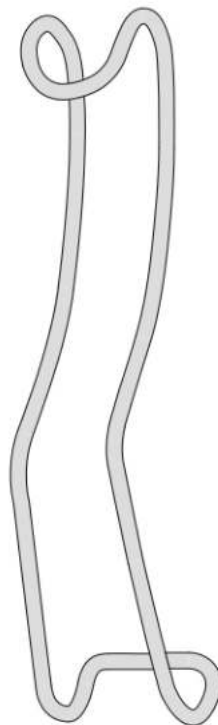
FARABEUF
ST-9234
150 mm



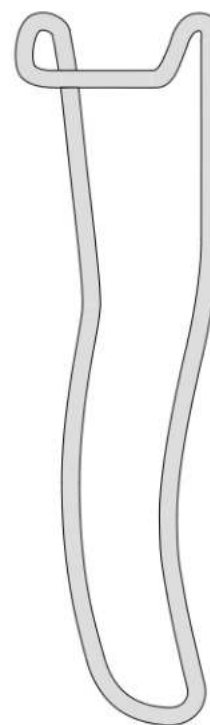
MATHIEU
ST-9235
200 mm



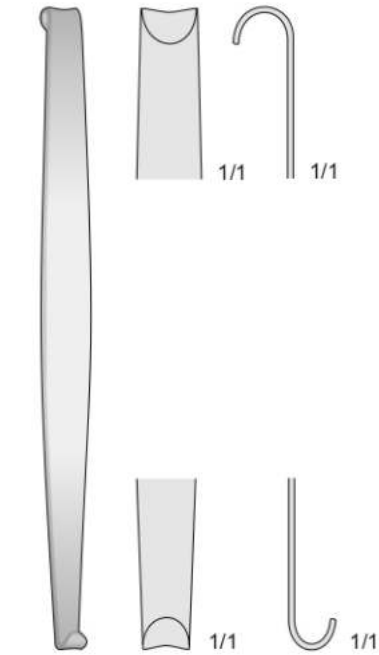
PARKER-LANGENBECK
ST-9236
210 mm



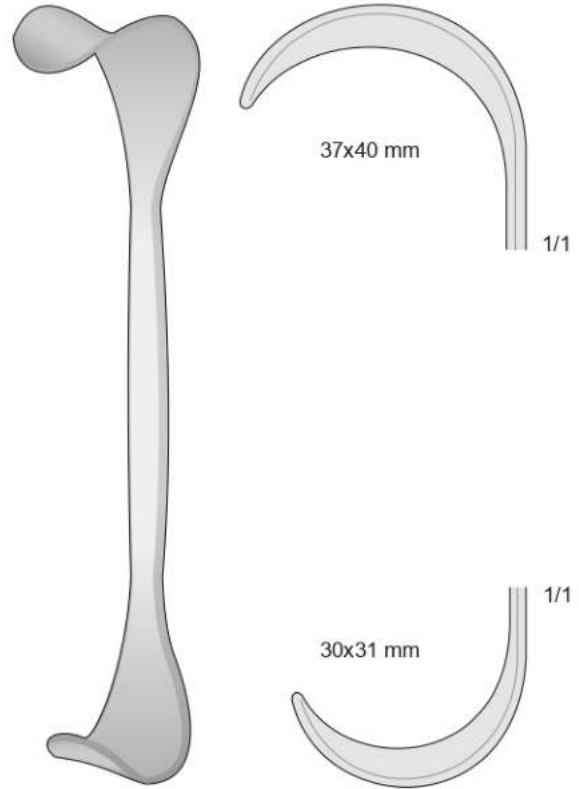
STERNBERG
ST-9237
160 mm



STERNBERG
ST-9238
160 mm



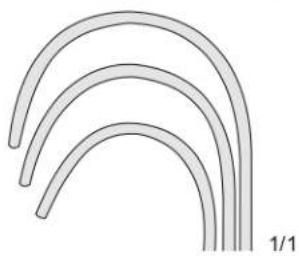
MINI-ROUX
ST-9239
150 mm



GOELET
09-530-19
190 mm

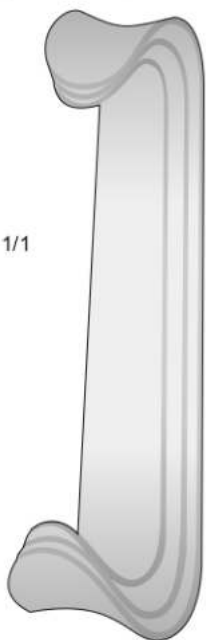
Set completo
Set complete
Komplettsæt
Set complet
Set completo

29 mm
26 mm
22 mm



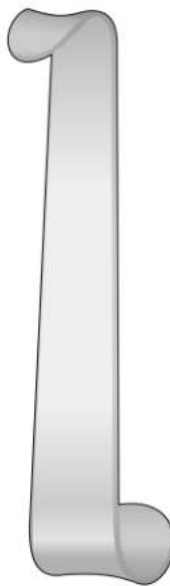
- ST-9241-1 - 20x22 mm
25x28 mm
- ST-9241-2 - 23x26 mm
29x38 mm
- ST-9241-3 - 29x29 mm
34x44 mm

28 mm
38 mm
44 mm



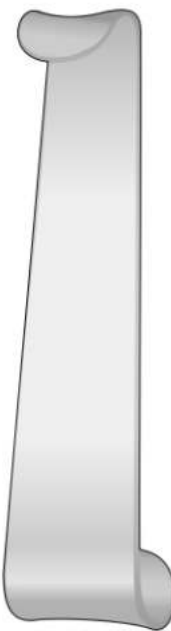
ROUX
ST-9241
165 mm

20x22 mm



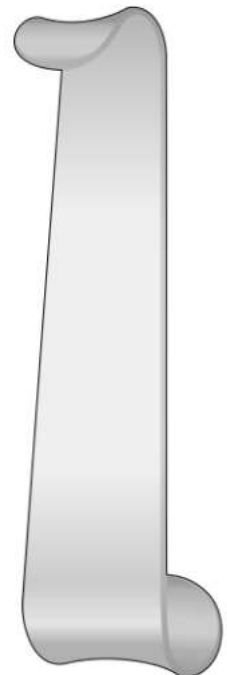
25x28 mm
ROUX-MAGNUS
ST-9242
150 mm

23x26 mm



29x38 mm
ROUX-MAGNUS
ST-9243
160 mm

29x29 mm



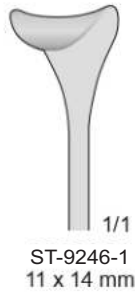
34x44 mm
ROUX-MAGNUS
ST-9244
170 mm



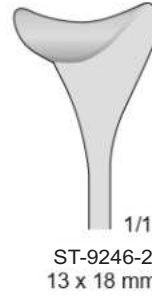
SCOVILLE
ST-9245
230 mm



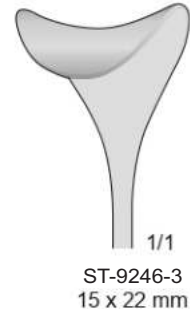
CUSHING
ST-9246
250 mm



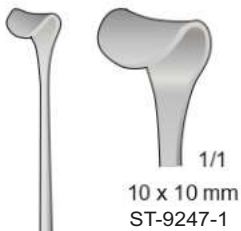
ST-9246-1
11 x 14 mm



ST-9246-2
13 x 18 mm



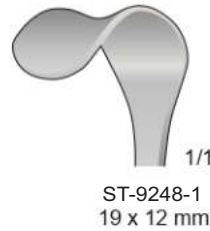
ST-9246-3
15 x 22 mm



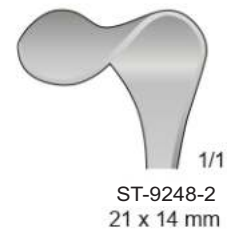
CUSHING-KOCHER
ST-9247
180 mm



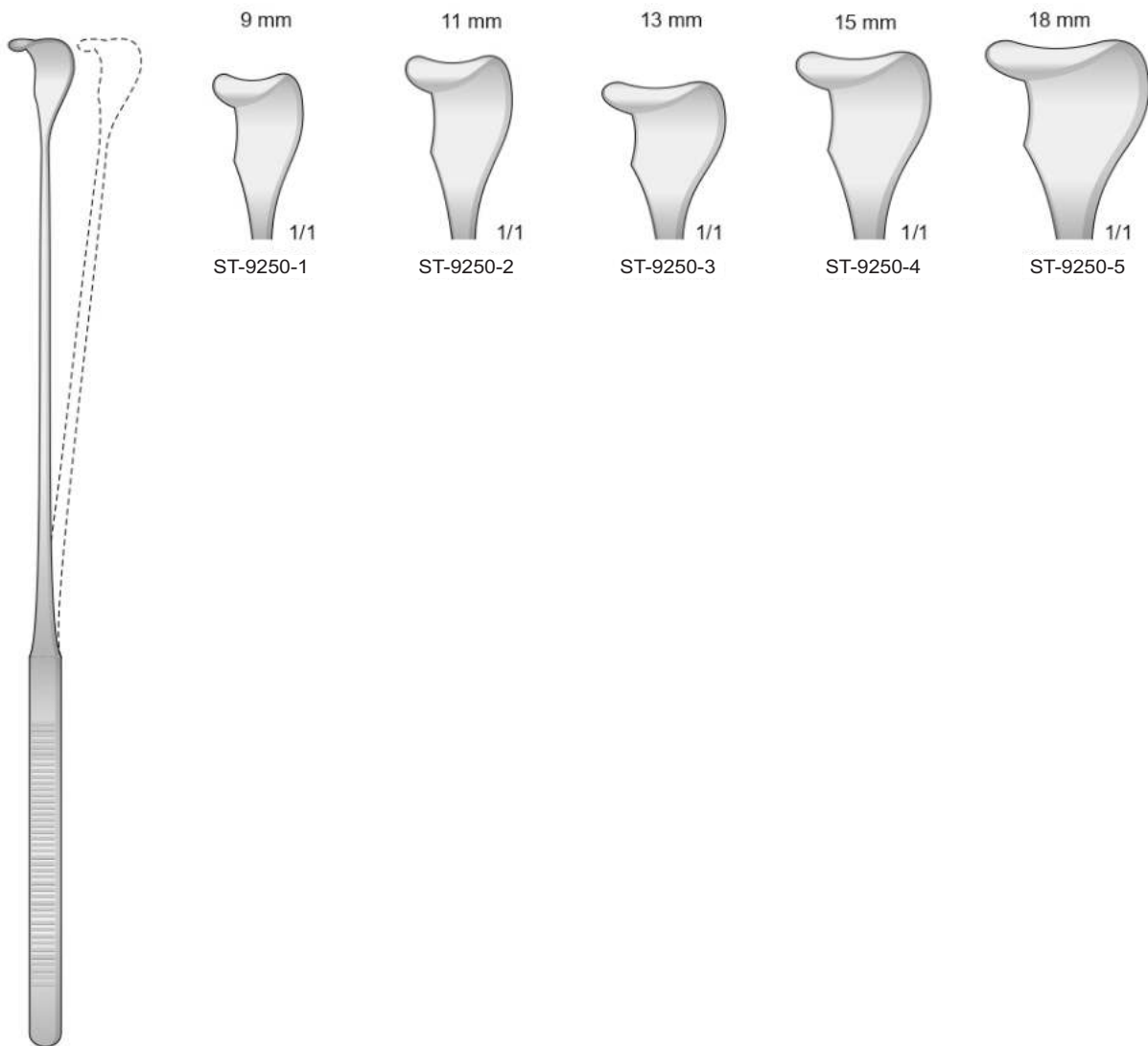
KOCHER
ST-9248
205 mm



ST-9248-1
19 x 12 mm



ST-9248-2
21 x 14 mm

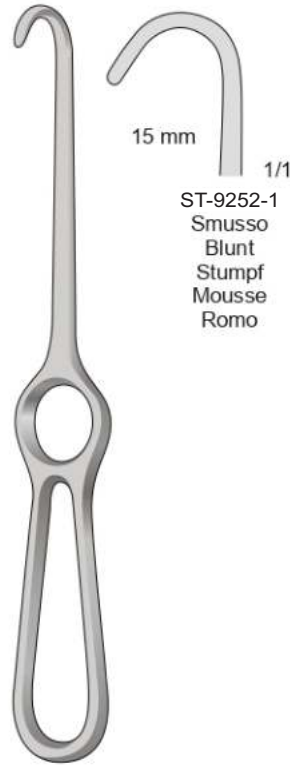


GIL-VERNET
ST-9250
280 mm



ST-9251-1
Acuto
Sharp
Spitz
Pointu
Agudo

KOCHER
ST-9251
205 mm



ST-9252-1
Smusso
Blunt
Stumpf
Mousse
Romo

KOCHER
ST-9252
220 mm



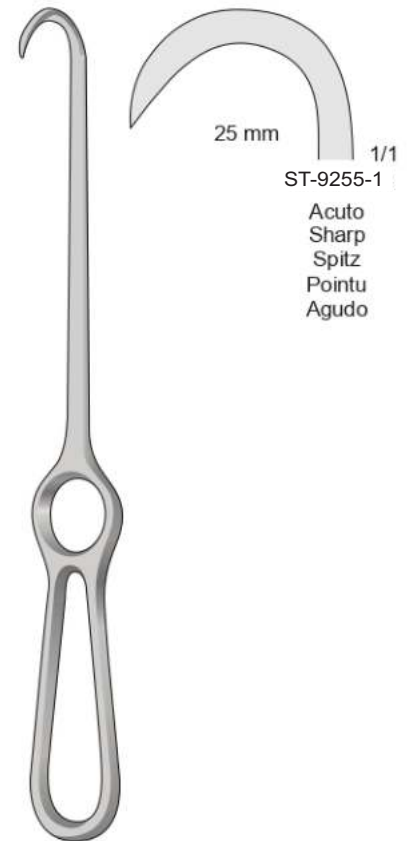
ST-9253-1
Acuto
Sharp
Spitz
Pointu
Agudo

VOLKMANN
ST-9253
220 mm



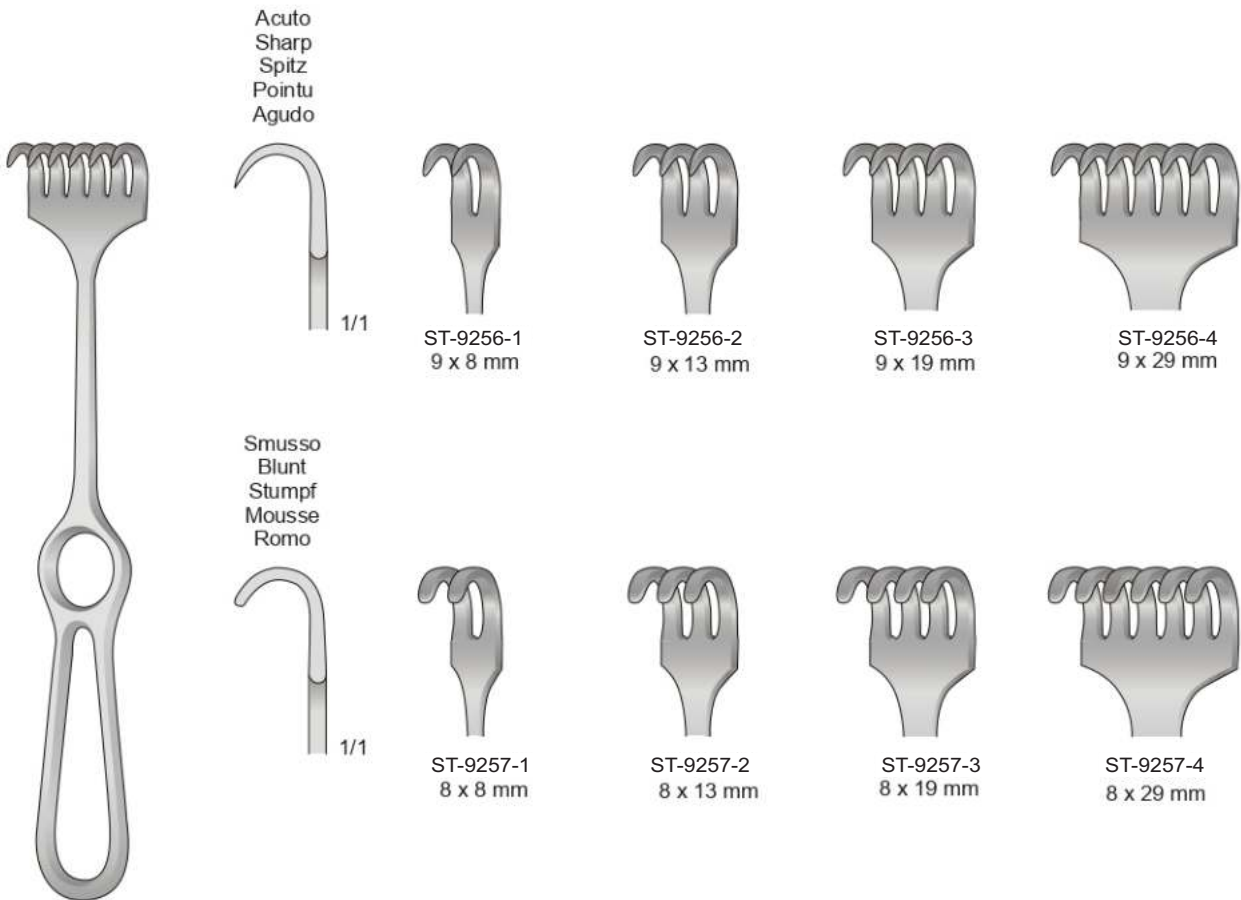
ST-9254-1
Smusso
Blunt
Stumpf
Mousse
Romo

VOLKMANN
ST-9254
220 mm

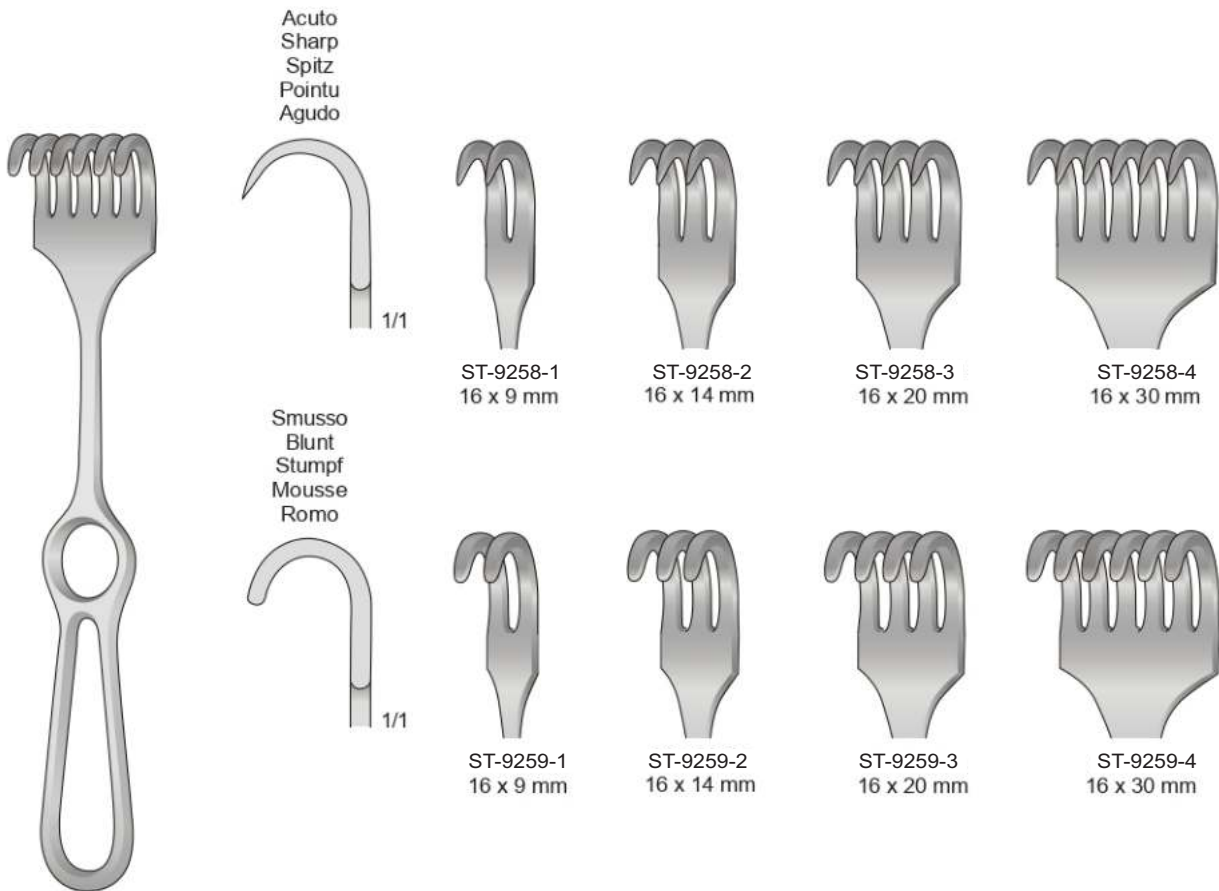


ST-9255-1
Acuto
Sharp
Spitz
Pointu
Agudo

ST-9255
245 mm



VOLKMANN
ST-9256 - ST-9257
220 mm



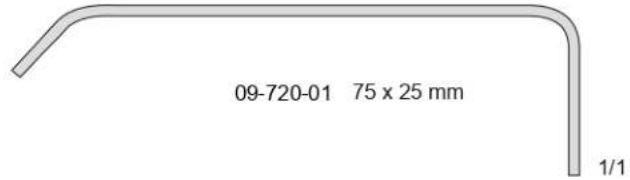
KOCHER
ST-9258 - ST-9259
220 mm



HIBBS
ST-9260
240 mm

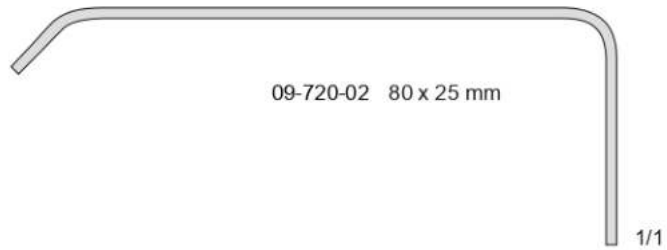


1/1



09-720-01 75 x 25 mm

1/1



09-720-02 80 x 25 mm

1/1



36 x 30 mm

OLLIER
ST-9261
225 mm



1/1



36 x 60 mm

OLLIER
ST-9262
225 mm

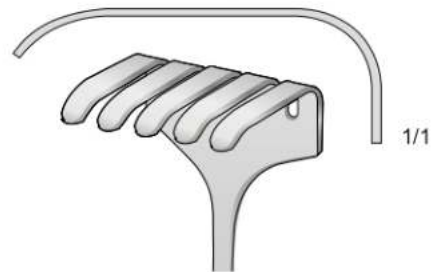


40 x 40 mm



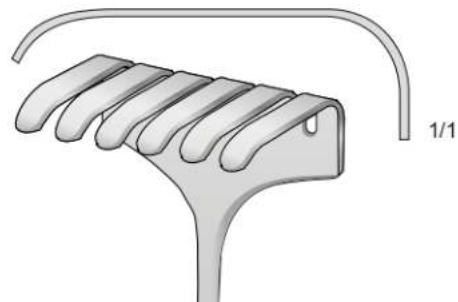
ST-9263-1

45 x 50 mm



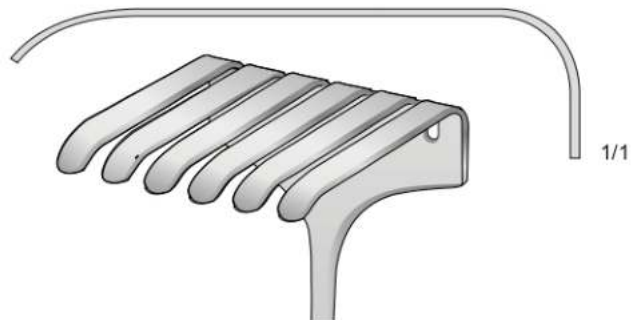
ST-9263-2

50 x 60 mm

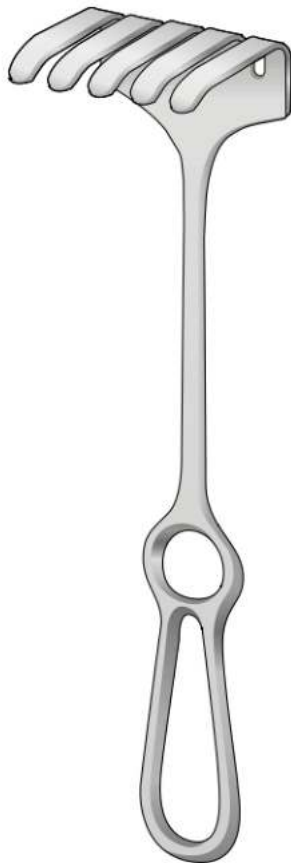


ST-9263-3

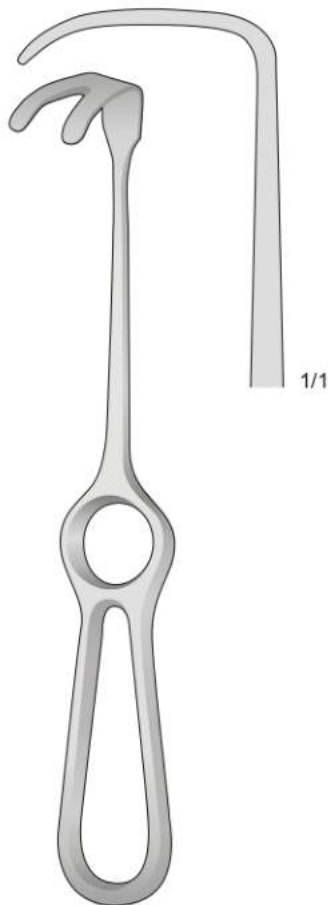
70 x 70 mm



ST-9263-4



ISRAEL
ST-9263
250 mm



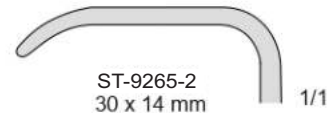
WASSMUND
ST-9264
220 mm



LANGENBECK
ST-9265
210 mm



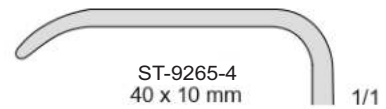
ST-9265-1
28 x 10 mm 1/1



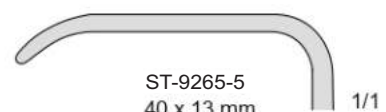
ST-9265-2
30 x 14 mm 1/1



ST-9265-3
33 x 14 mm 1/1



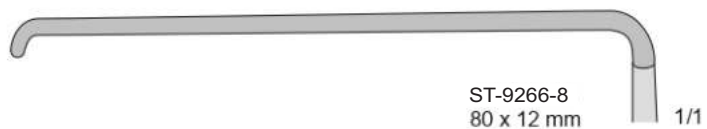
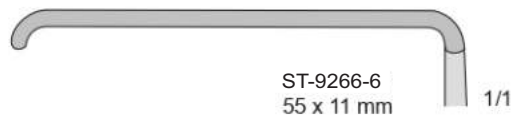
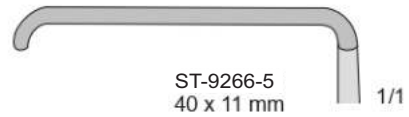
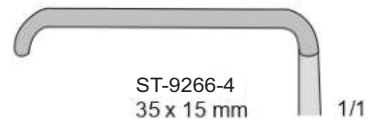
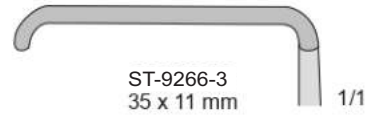
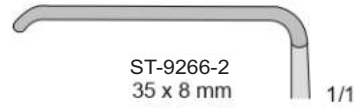
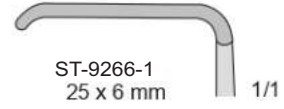
ST-9265-4
40 x 10 mm 1/1



ST-9265-5
40 x 13 mm 1/1

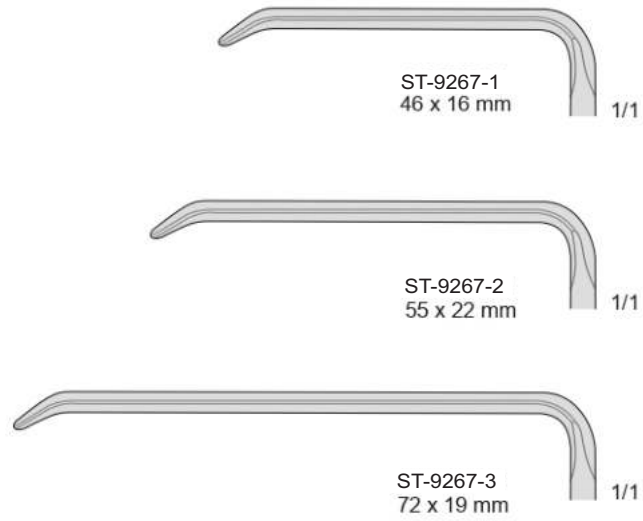


KOCHER-LANGENBECK
ST-9266
215 mm

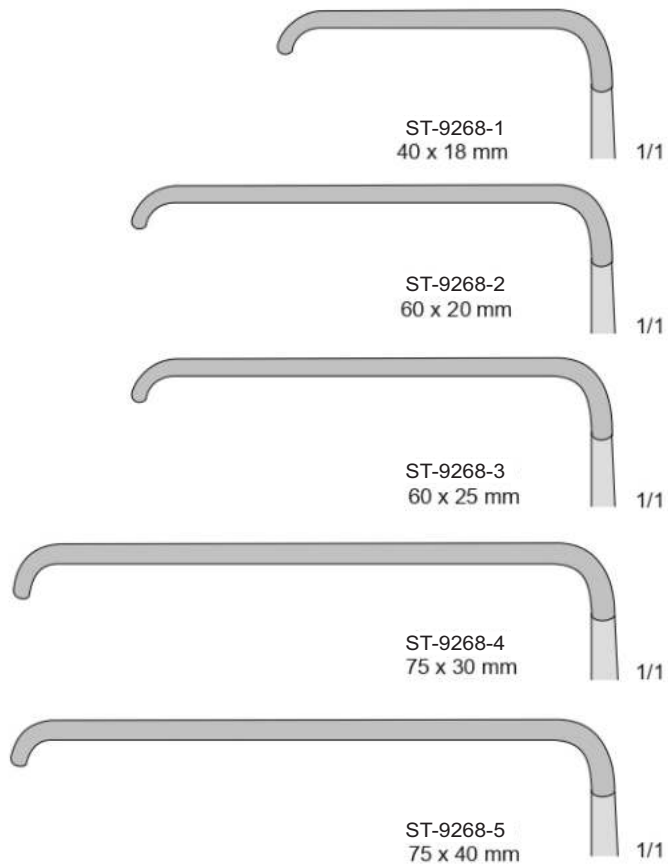




SAUERBRUCH
ST-9267
225 mm

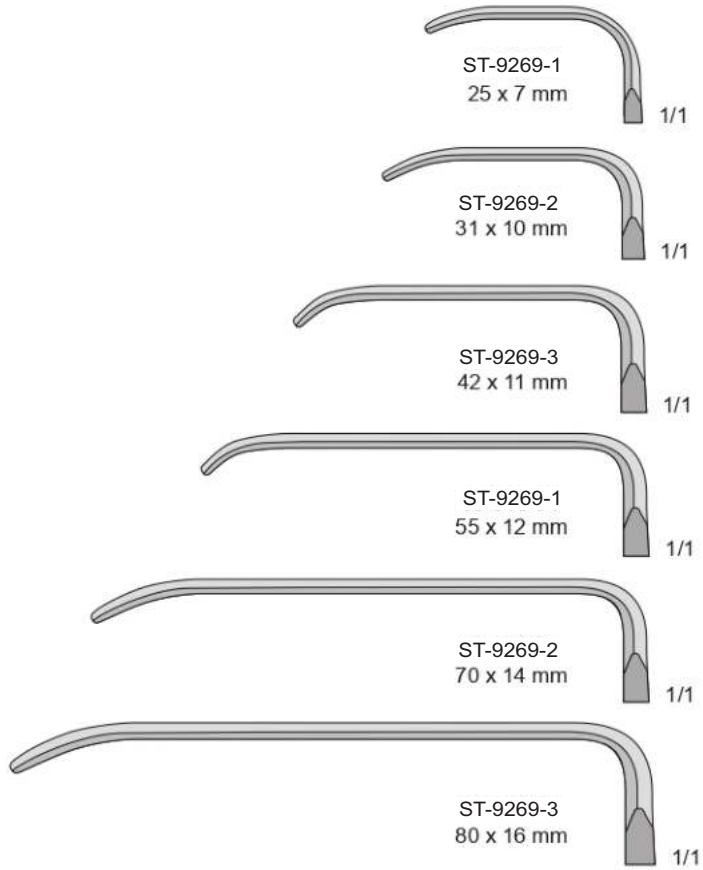


KOCHER
ST-9268
230 mm

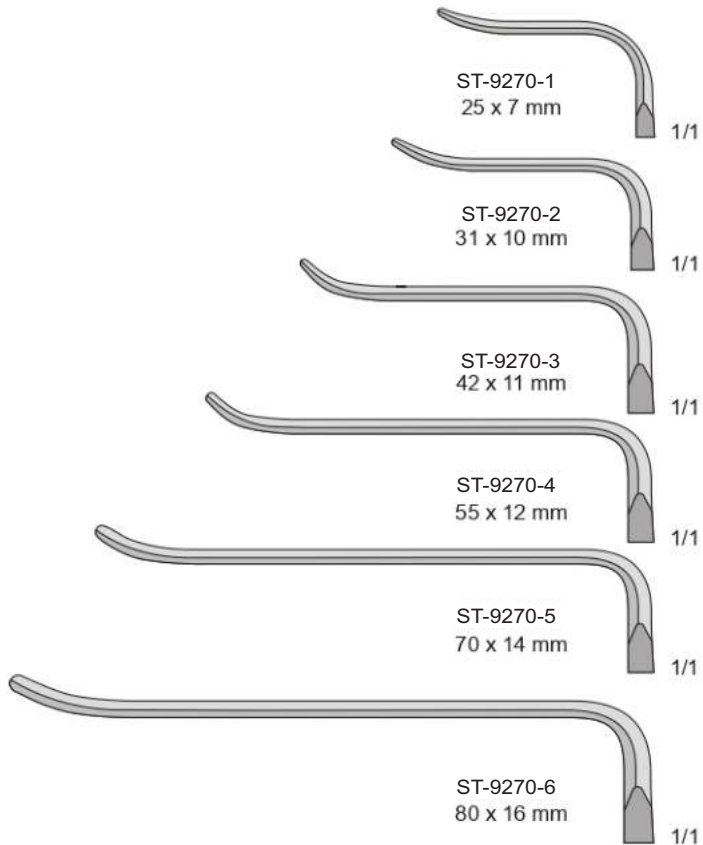


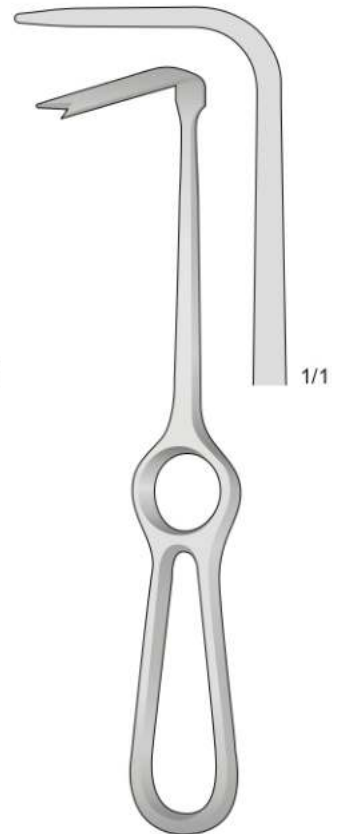
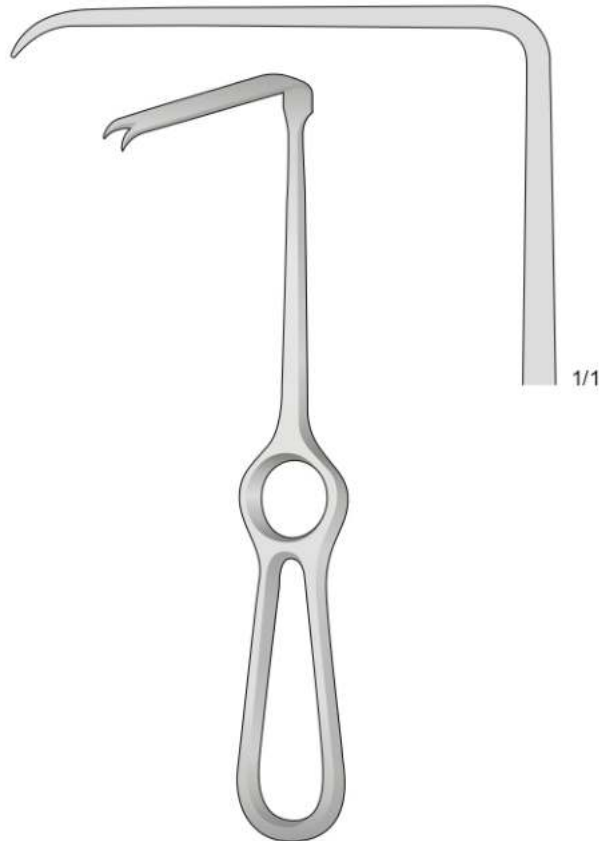
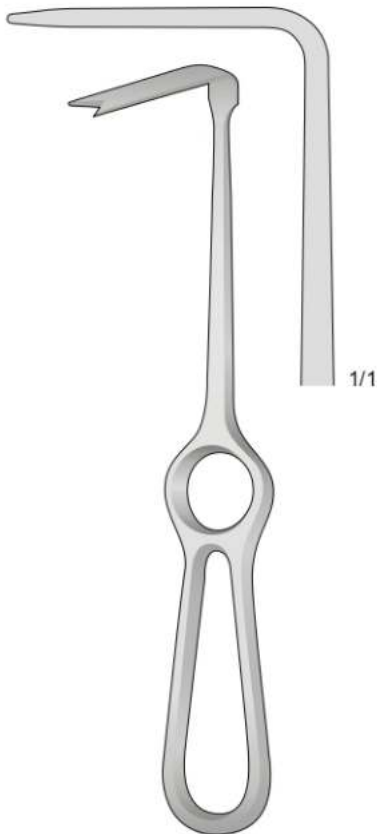
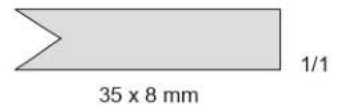
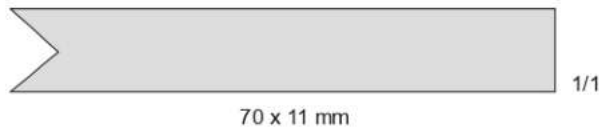
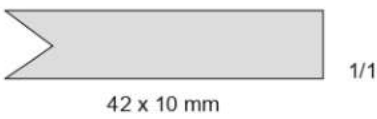


OBWEGESER
ST-9269
220 mm



OBWEGESER
ST-9270
220 mm

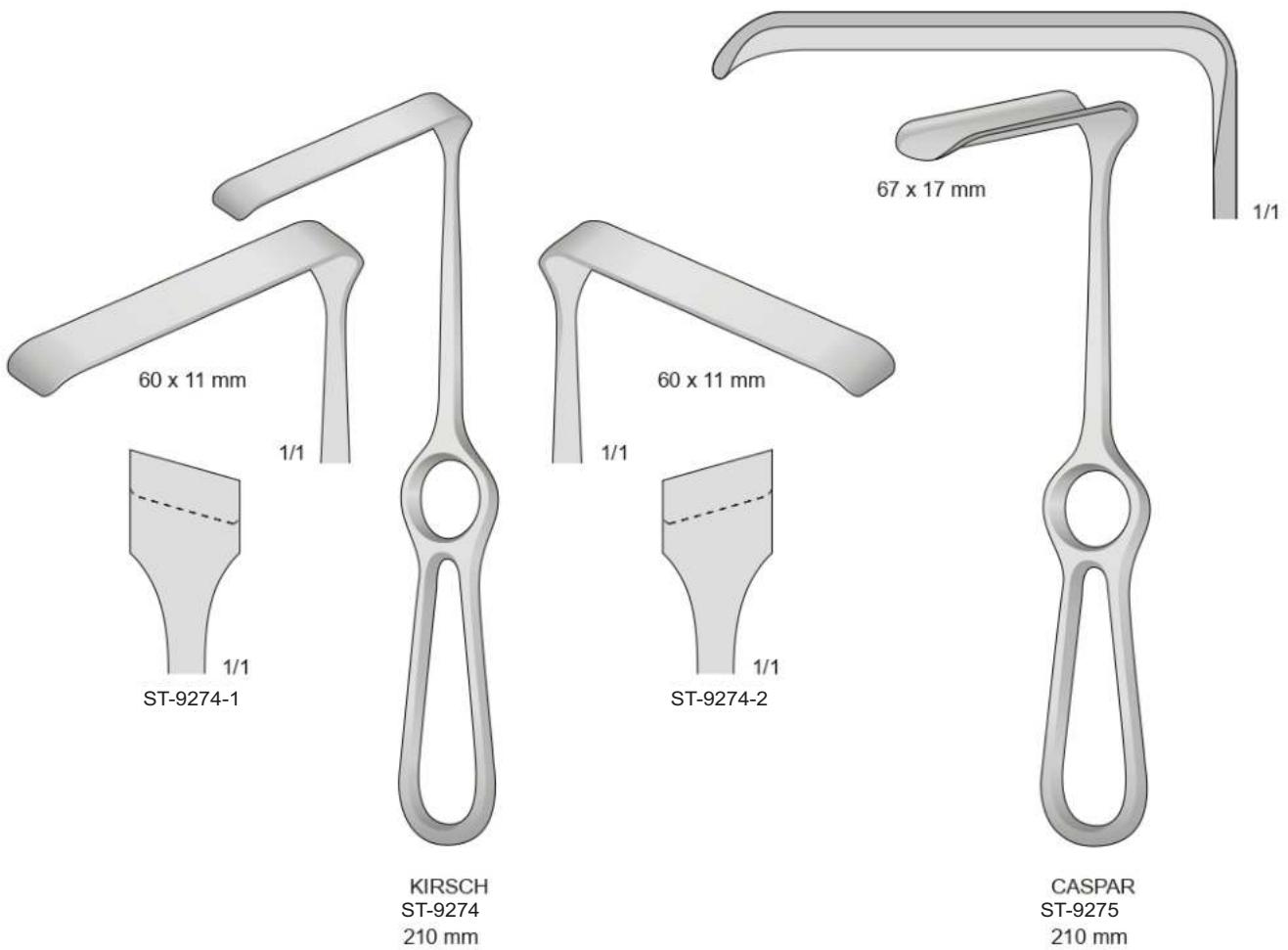


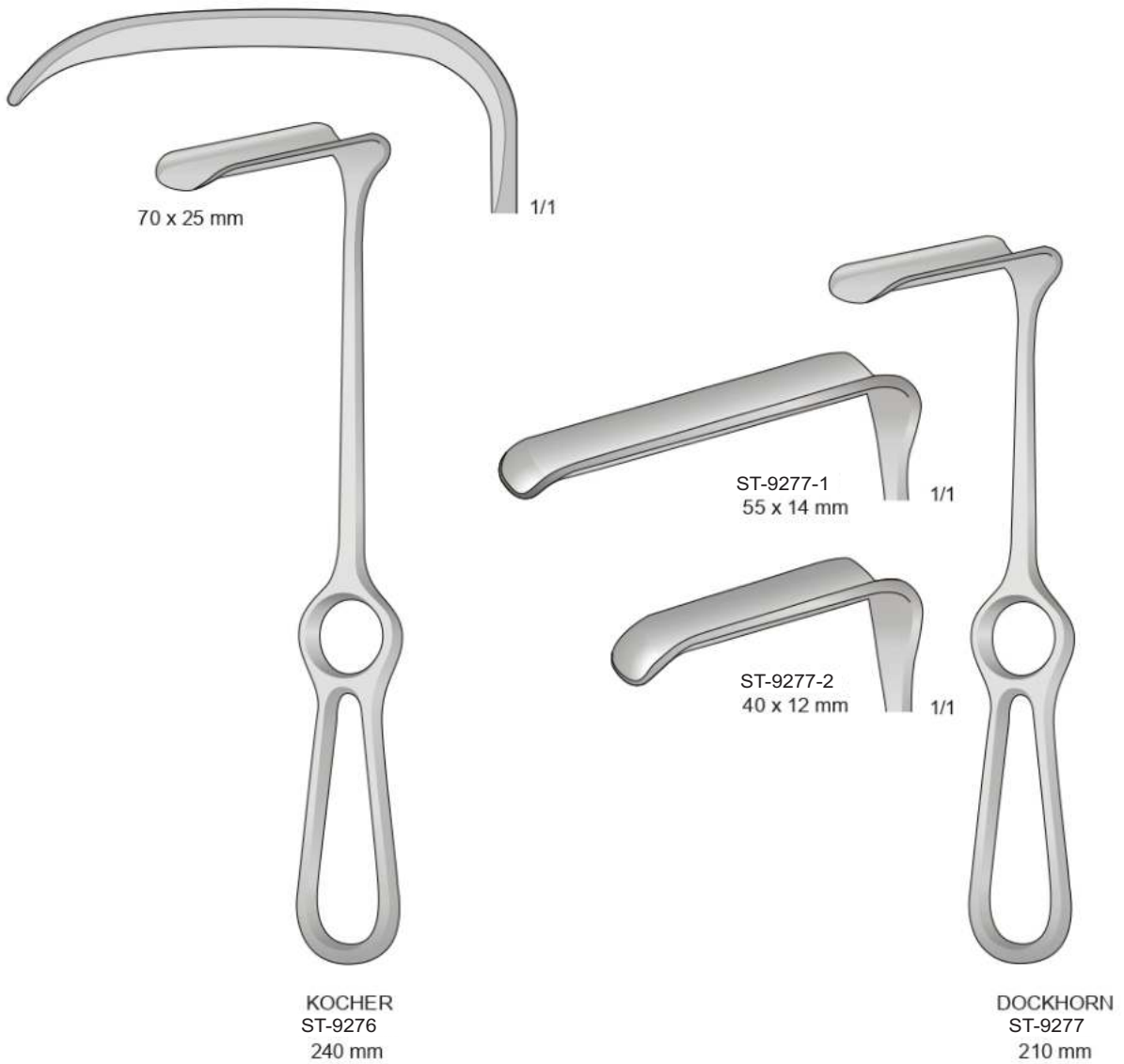


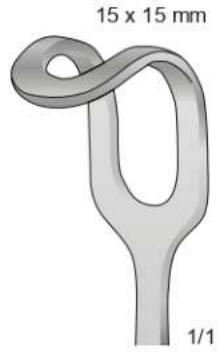
OBWEGESER
ST-9271
215 mm

ST-9272
220 mm

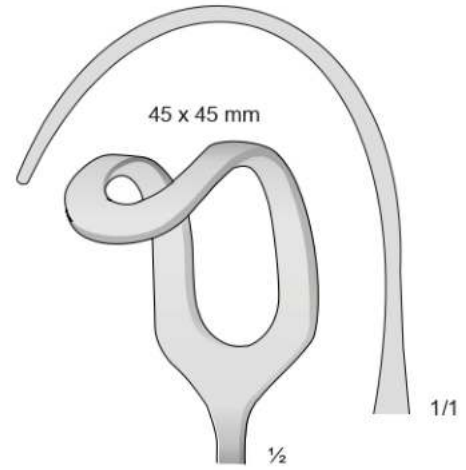
ST-9273
215 mm



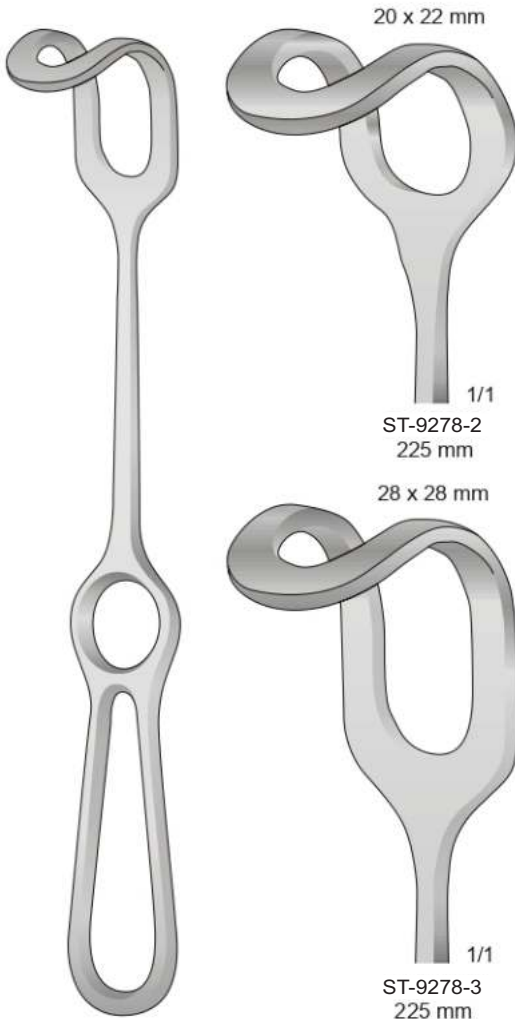




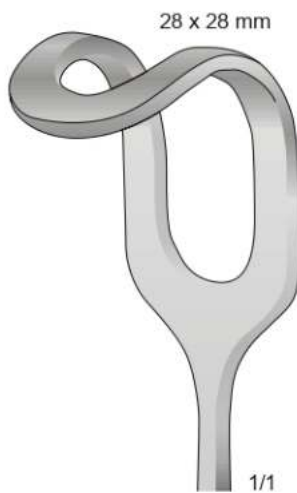
ST-9278-1
225 mm



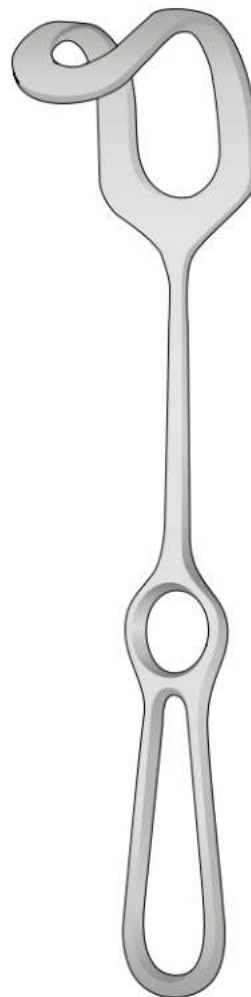
ST-9279-1
255 mm



ST-9278-2
225 mm



ST-9278-3
225 mm



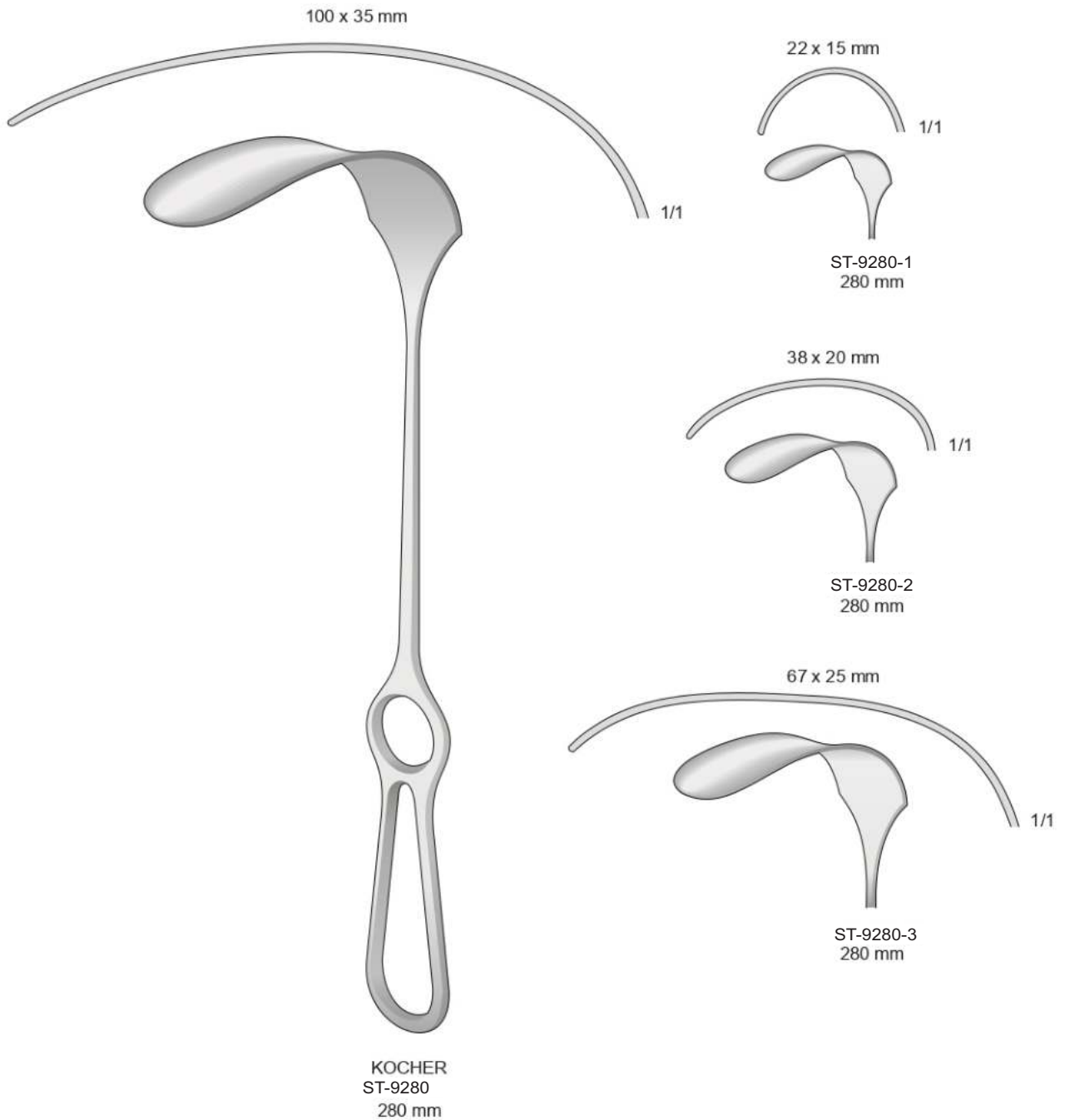
ST-9279-2
255 mm

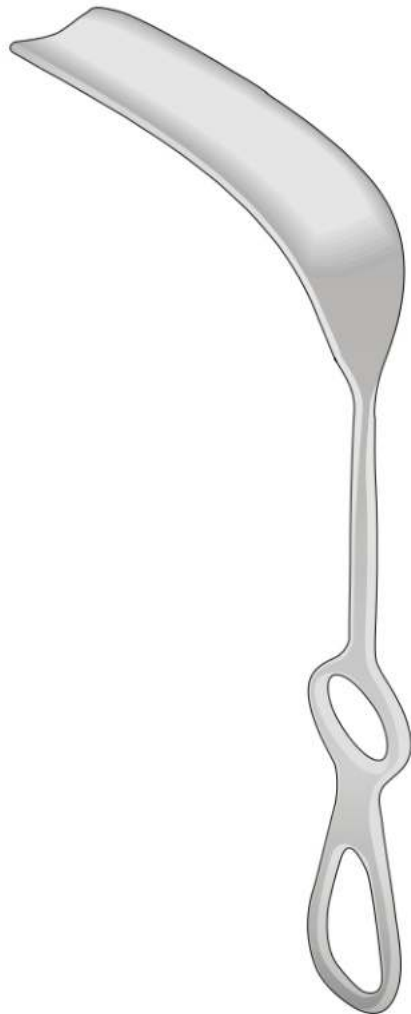
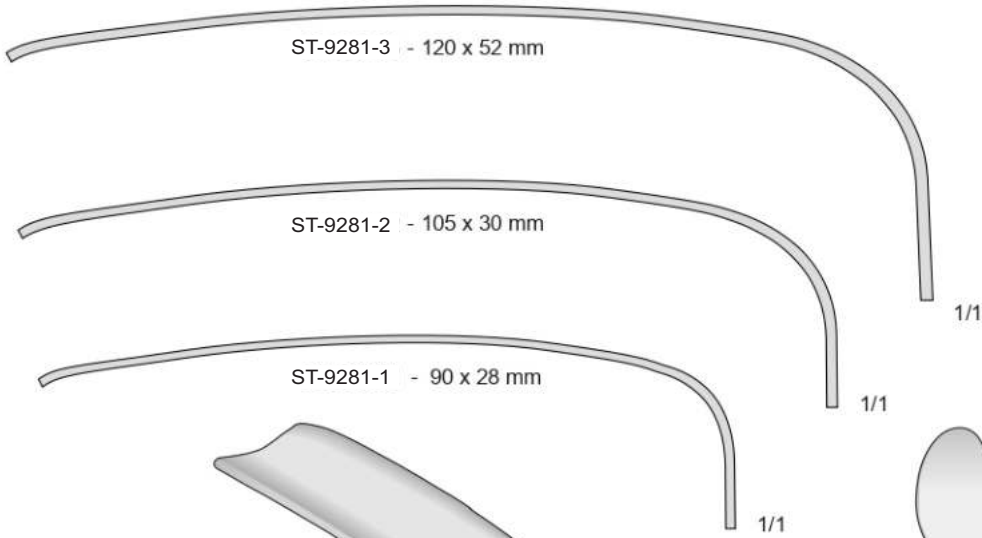


ST-9279-3
255 mm

MIDDELDORPF
ST-9278
225 mm

MIDDELDORPF
ST-9279
255 mm

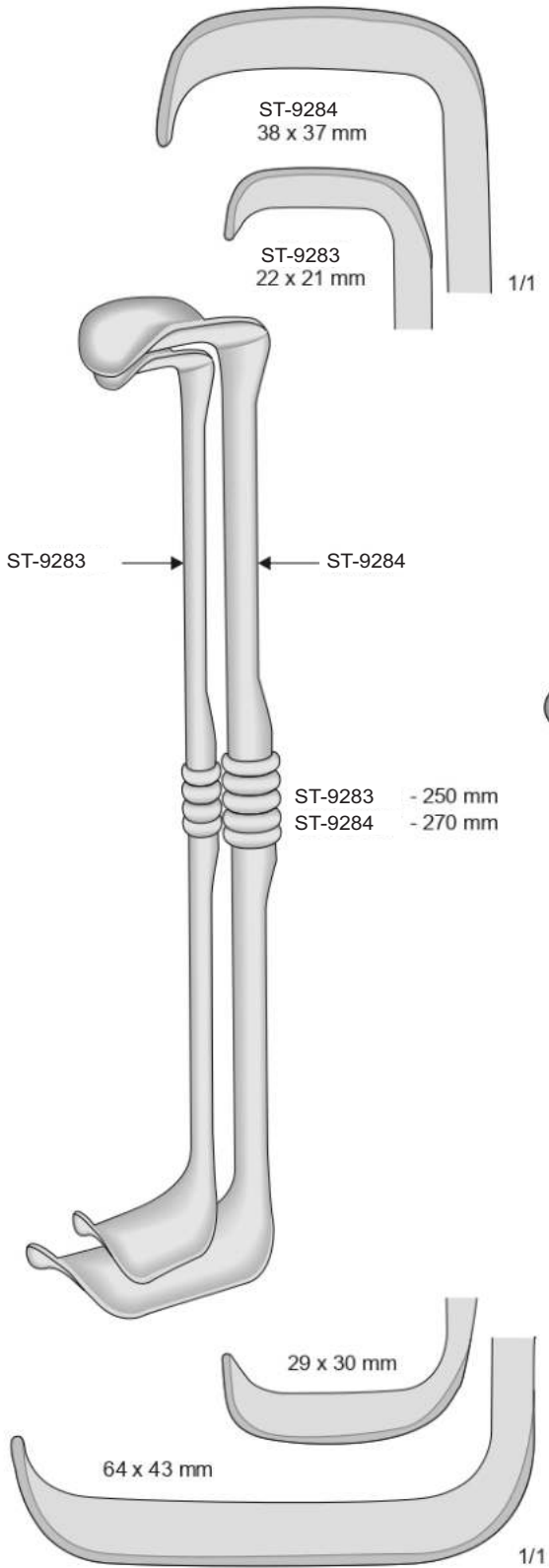




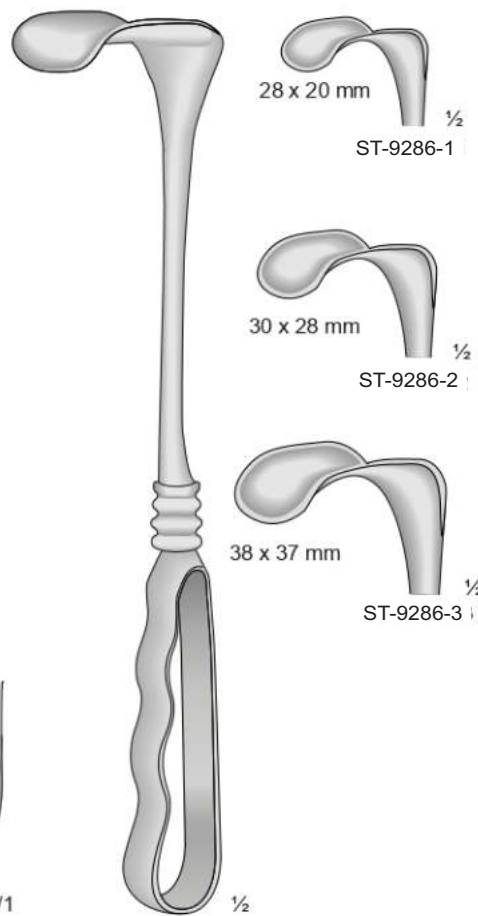
DOYEN-STILLE
ST-9281
220 mm



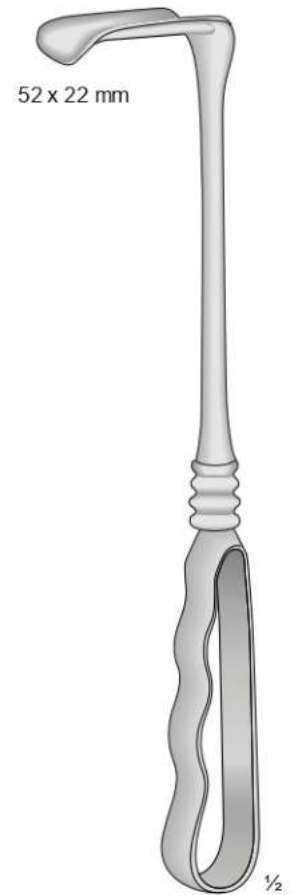
DOYEN
ST-9282
250 mm



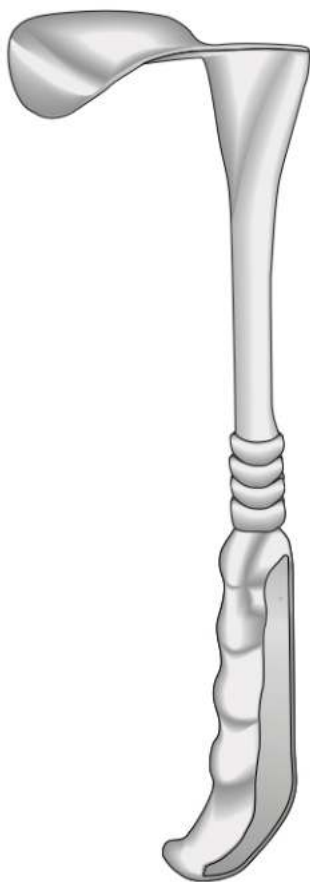
RICHARDSON-EASTMAN
ST-9285
Set 2 pezzi



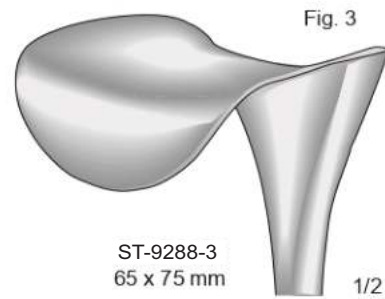
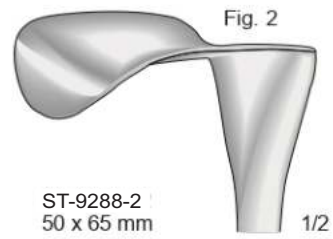
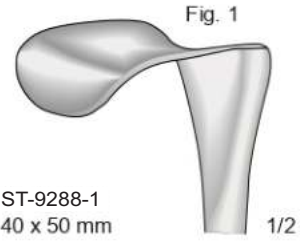
RICHARDSON
ST-9286
240 mm

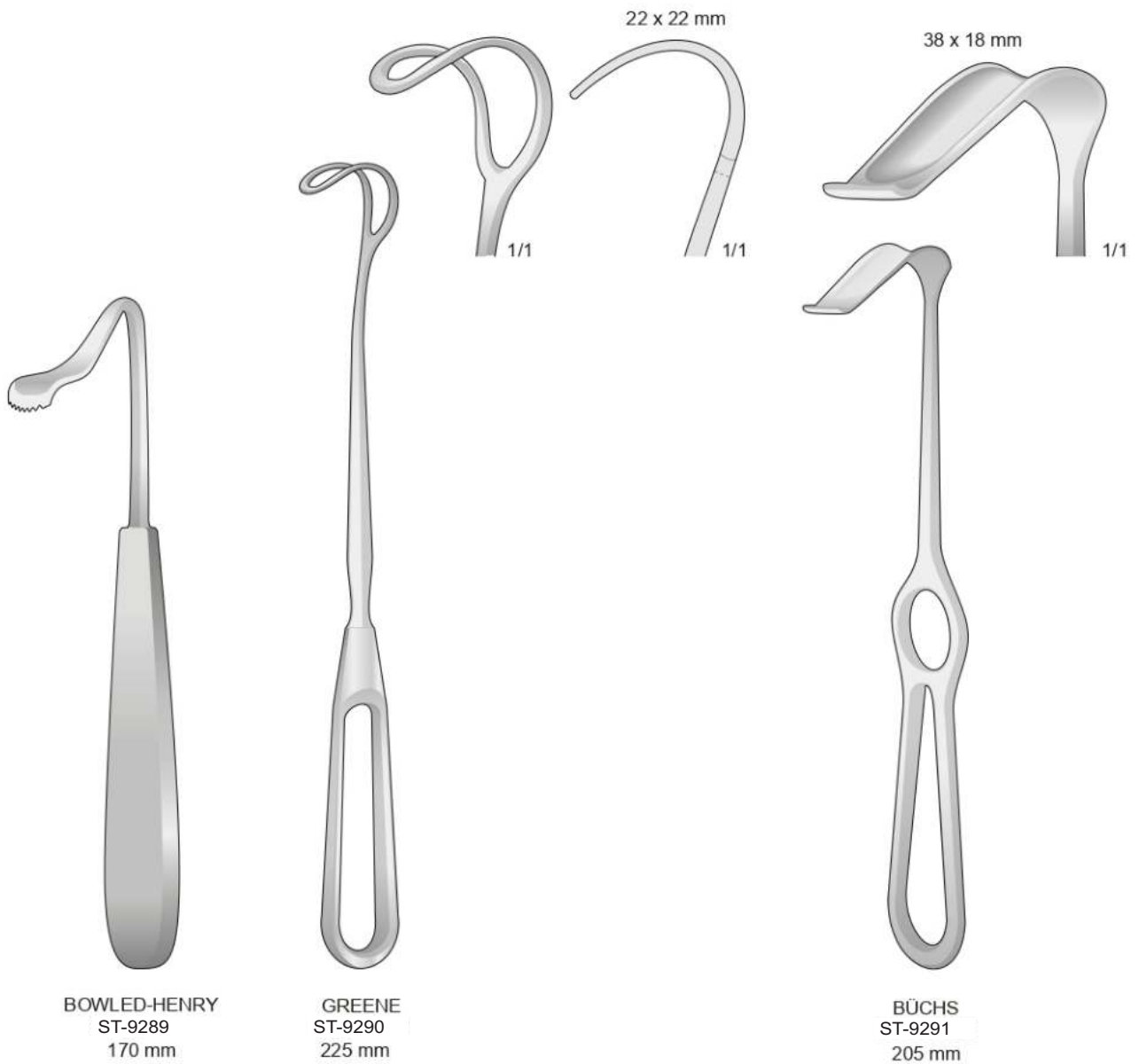


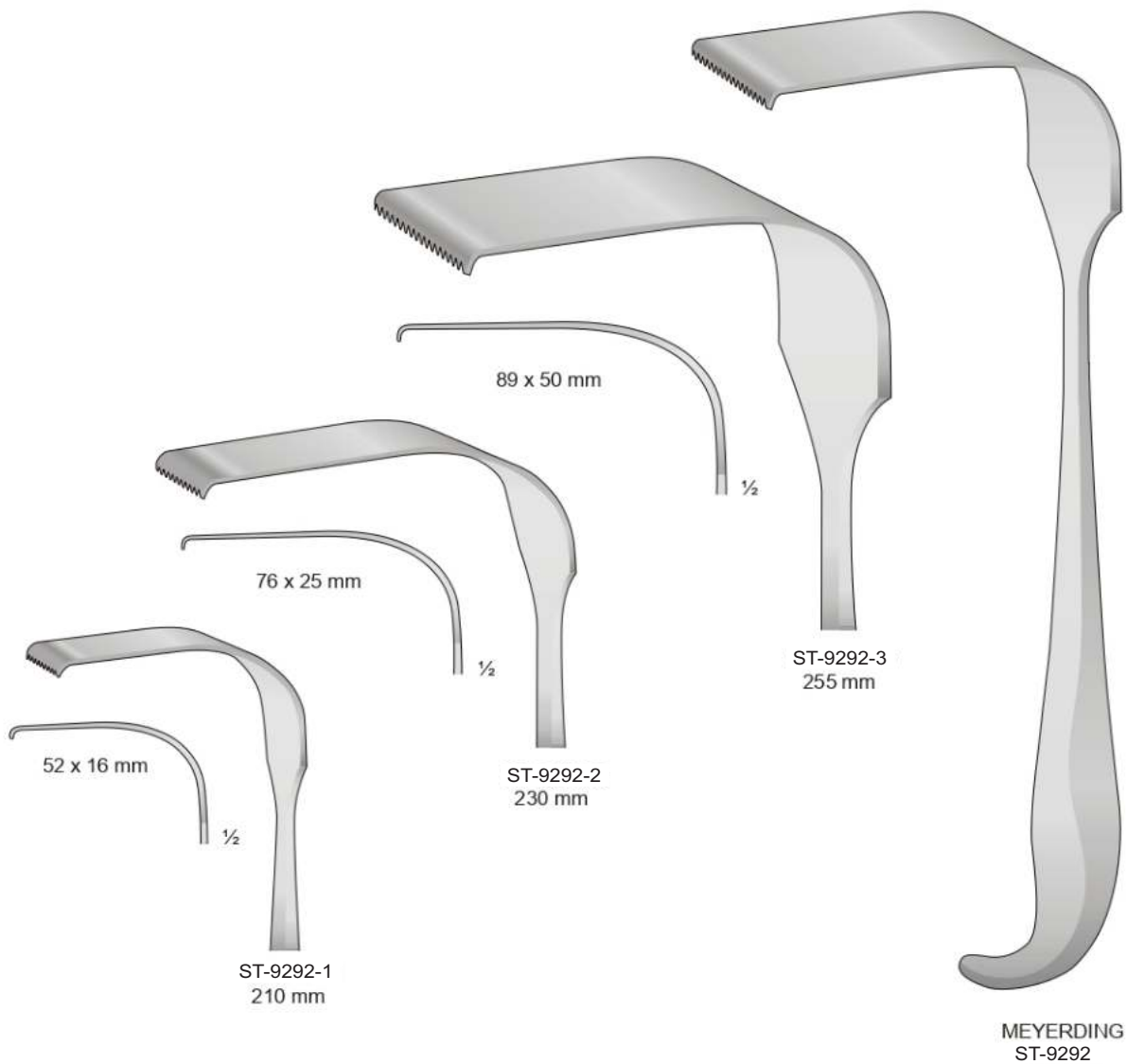
RICHARDSON
ST-9287
240 mm

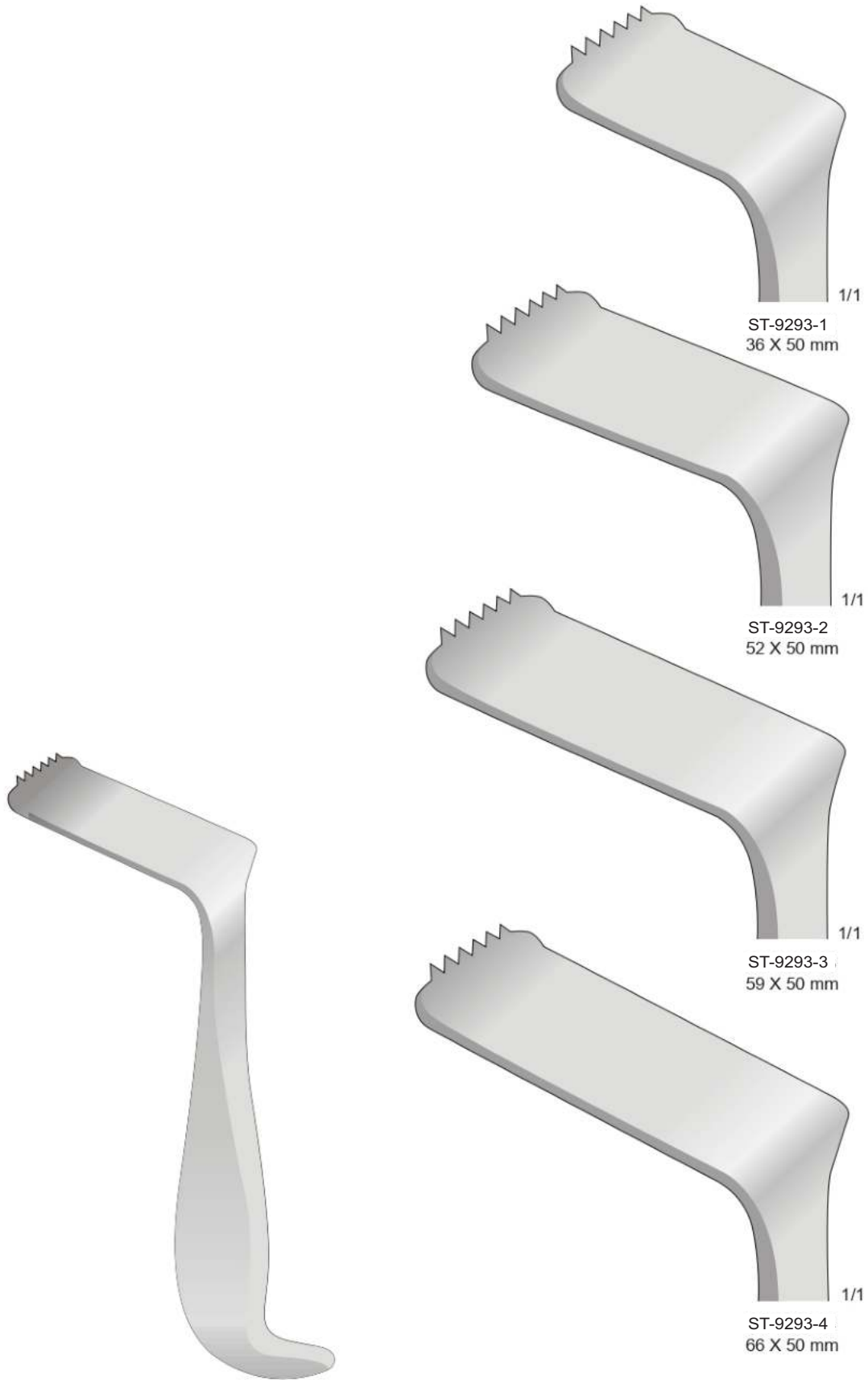


KELLY
ST-9288
260 mm









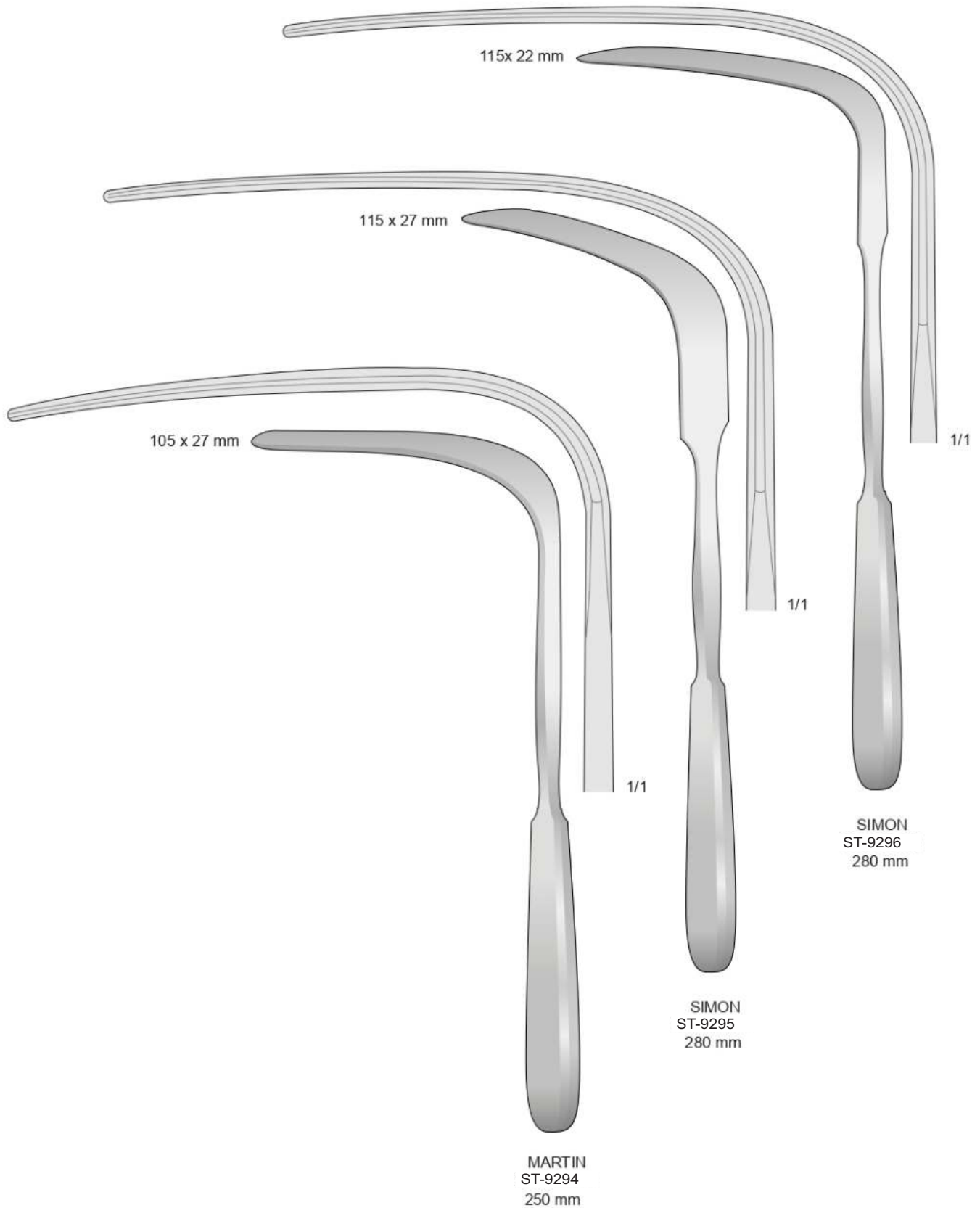
TESSIER
ST-9293
180 mm

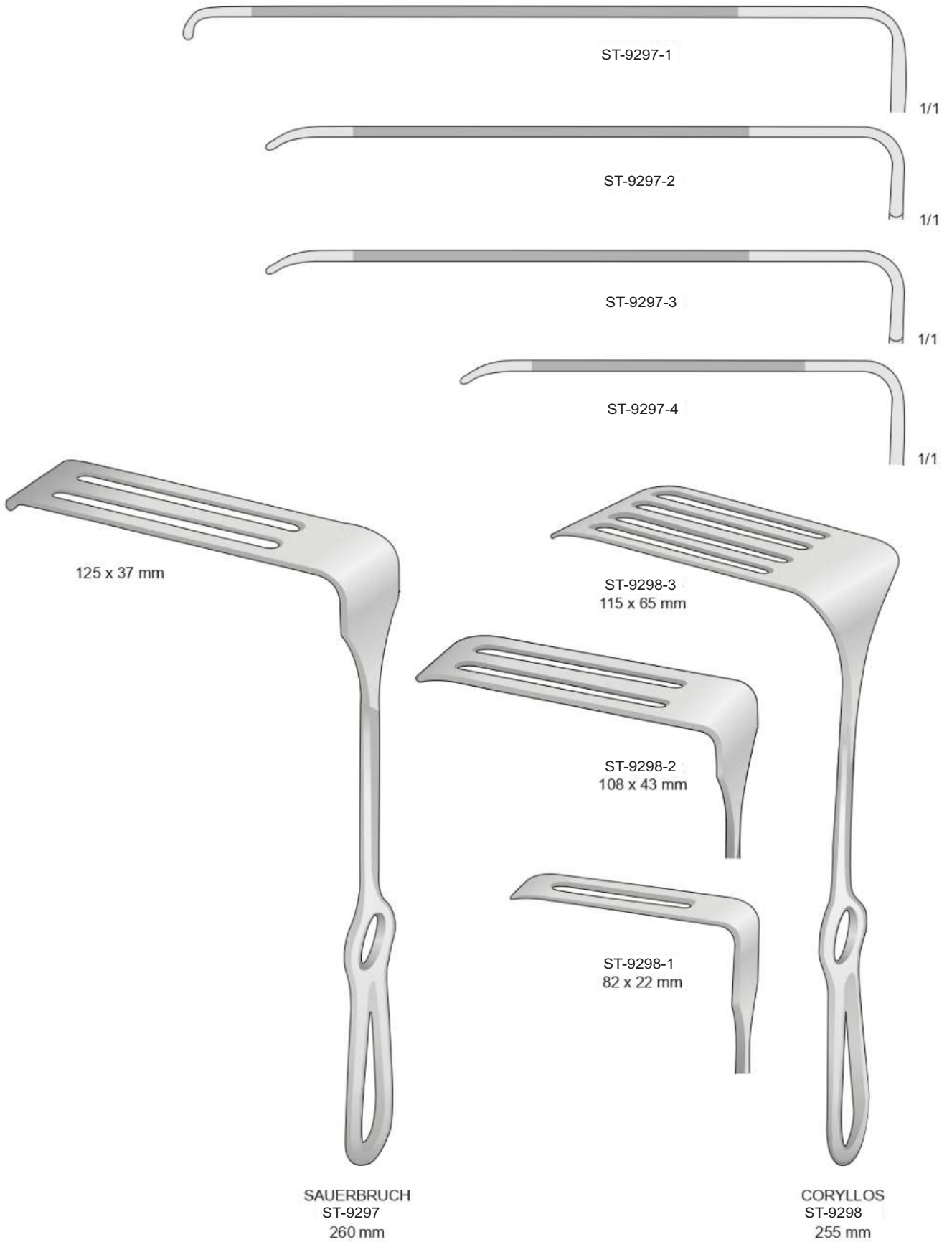
ST-9293-4
66 X 50 mm

ST-9293-3
59 X 50 mm

ST-9293-2
52 X 50 mm

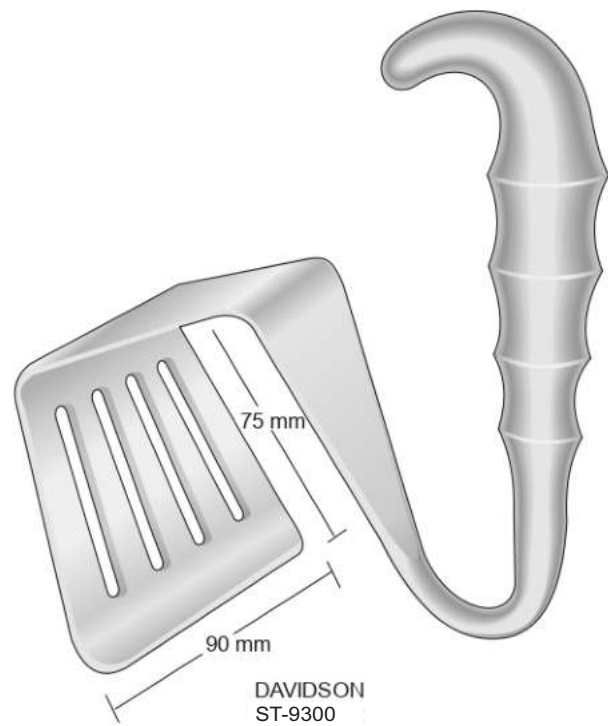
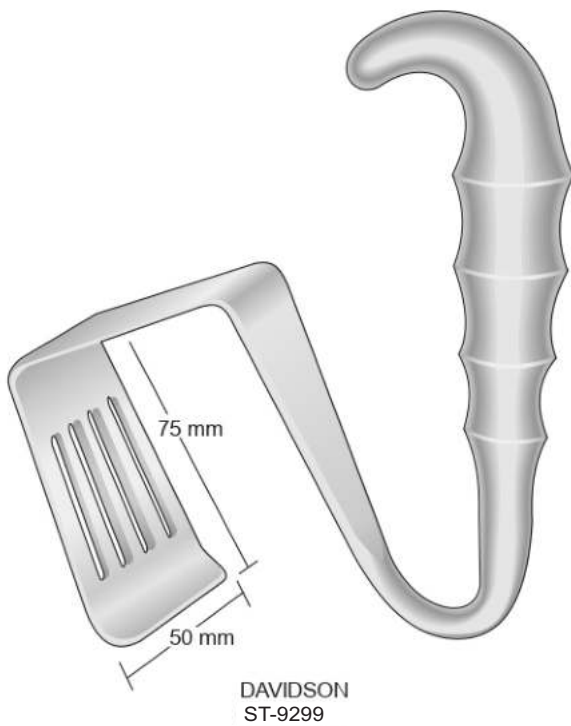
ST-9293-1
36 X 50 mm

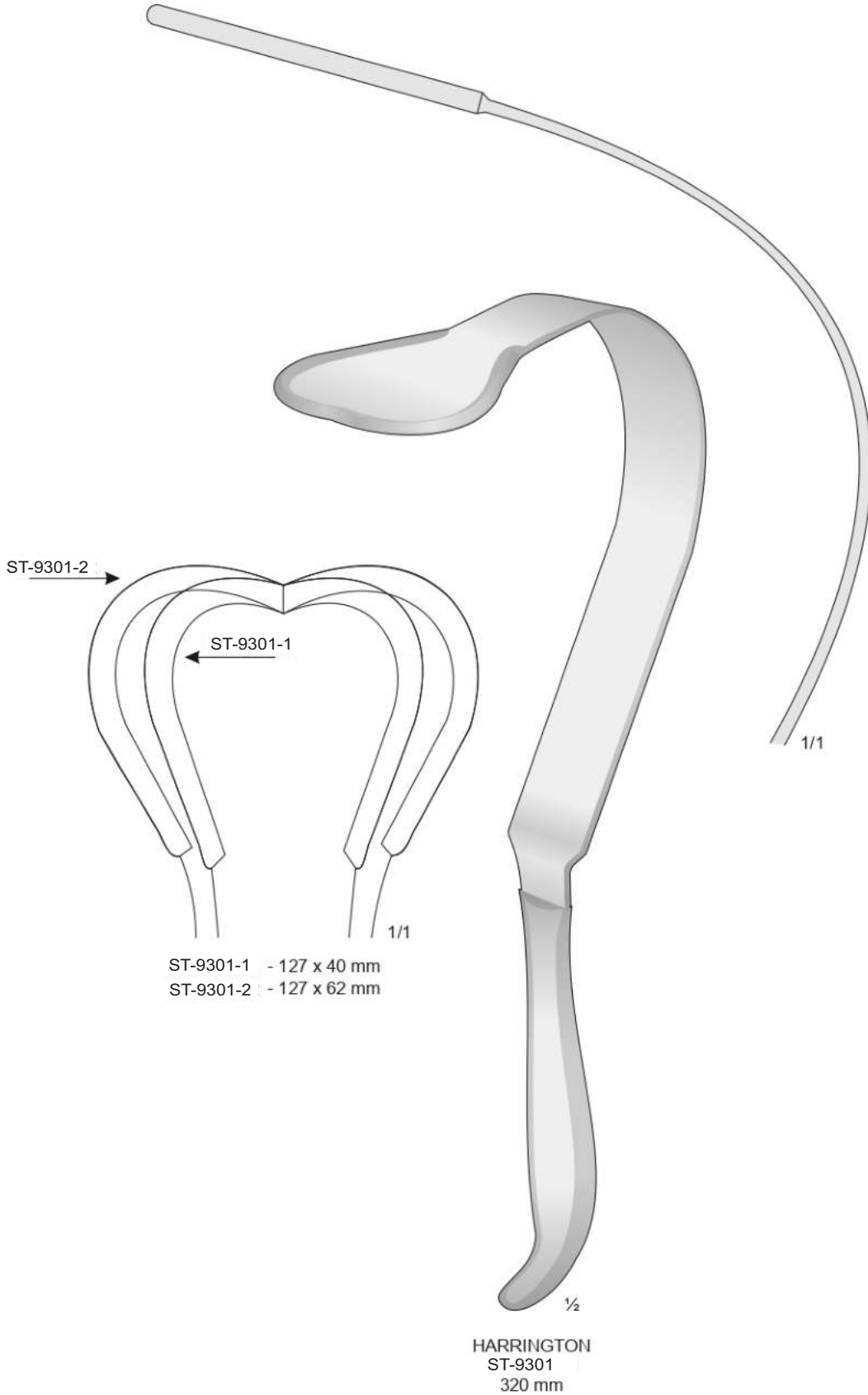






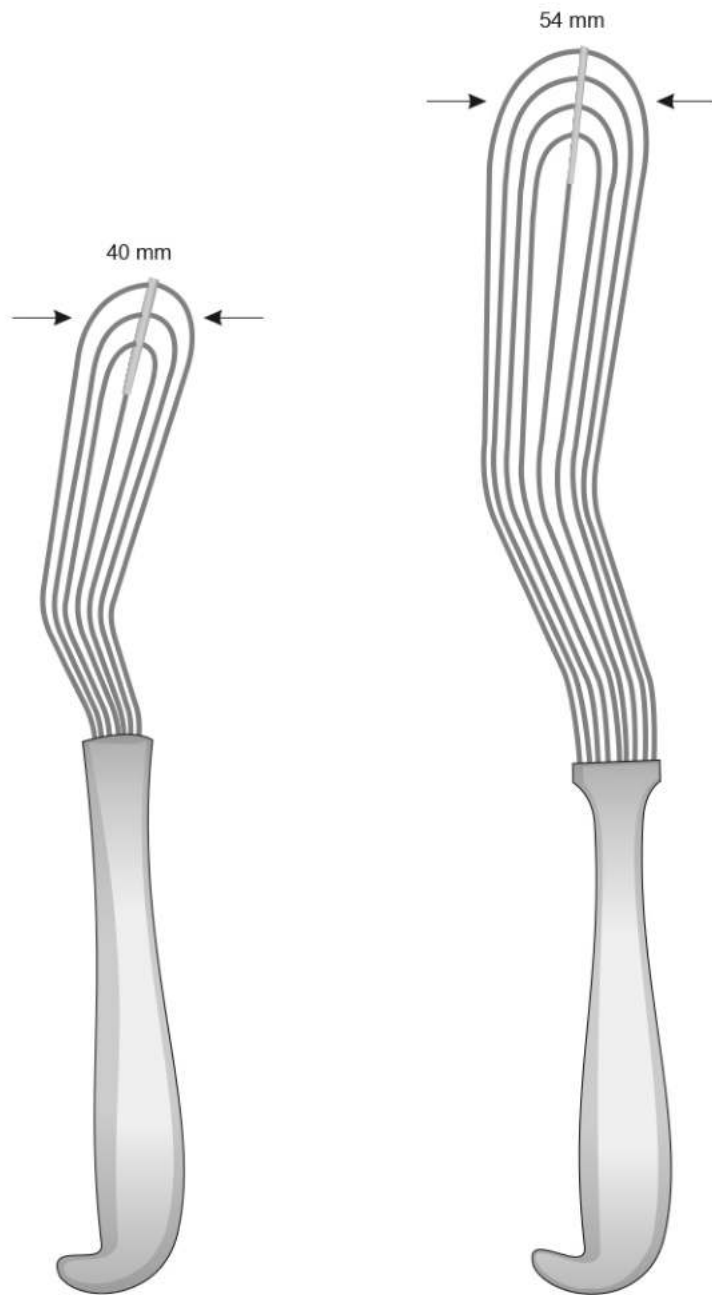
Retrattori per scapola
Scapula retractors
Scapula-Haken
Ecarteurs pour scapula
Separadores para scápula







Spatole per polmone
Lung spatulas
Lungenspatel
Spatules pulmonaires
Espátulas pulmonares

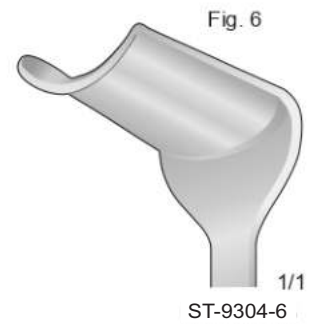


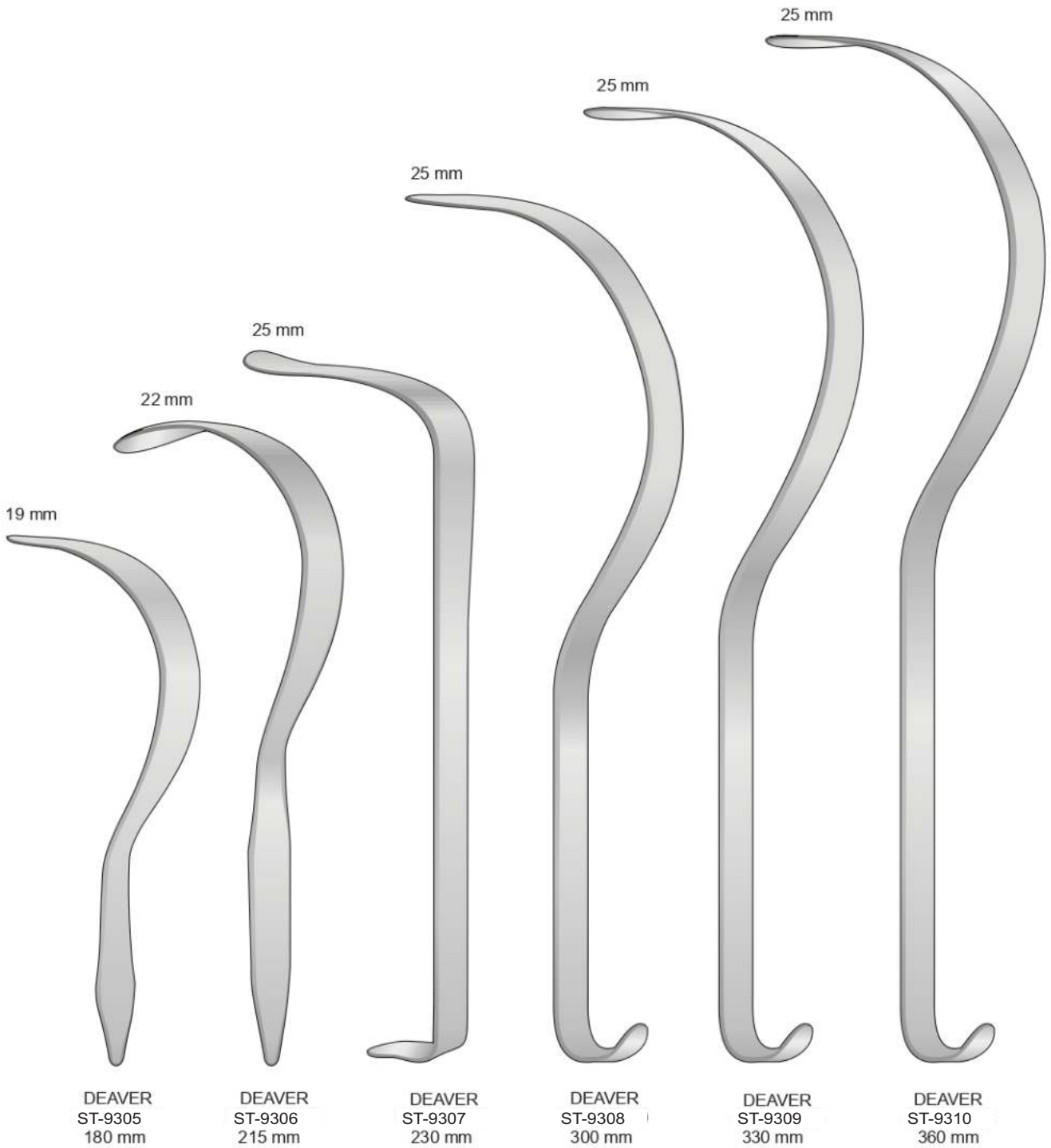
ALLISON
ST-9302
255 mm

ALLISON
ST-9303
320 mm



ROSS
ST-9304
270 mm





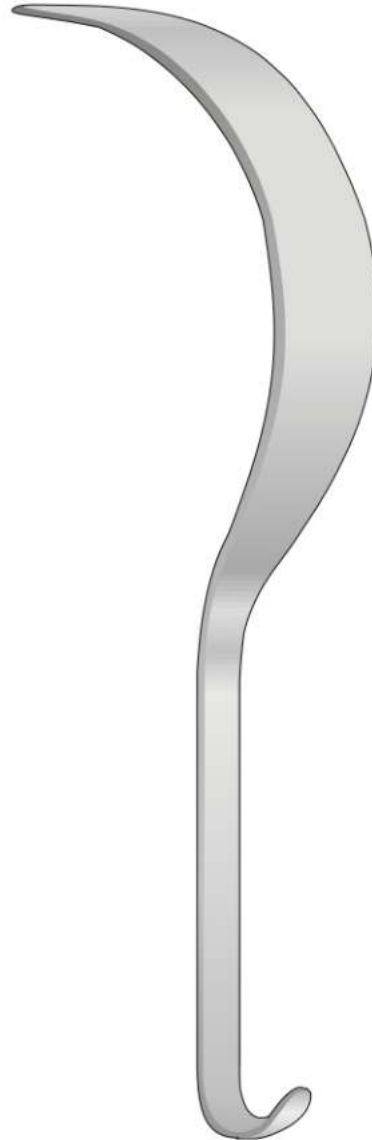


38 mm



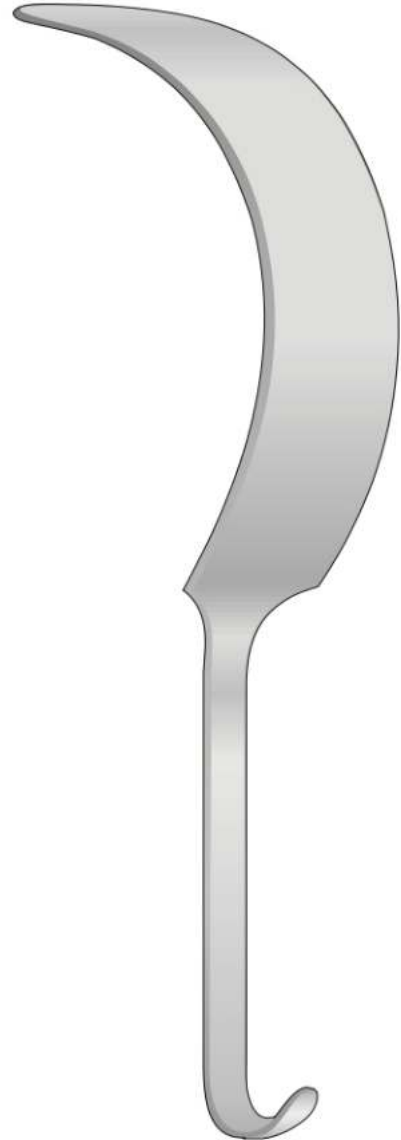
DEAVER
ST-9311-1
300 mm

50 mm

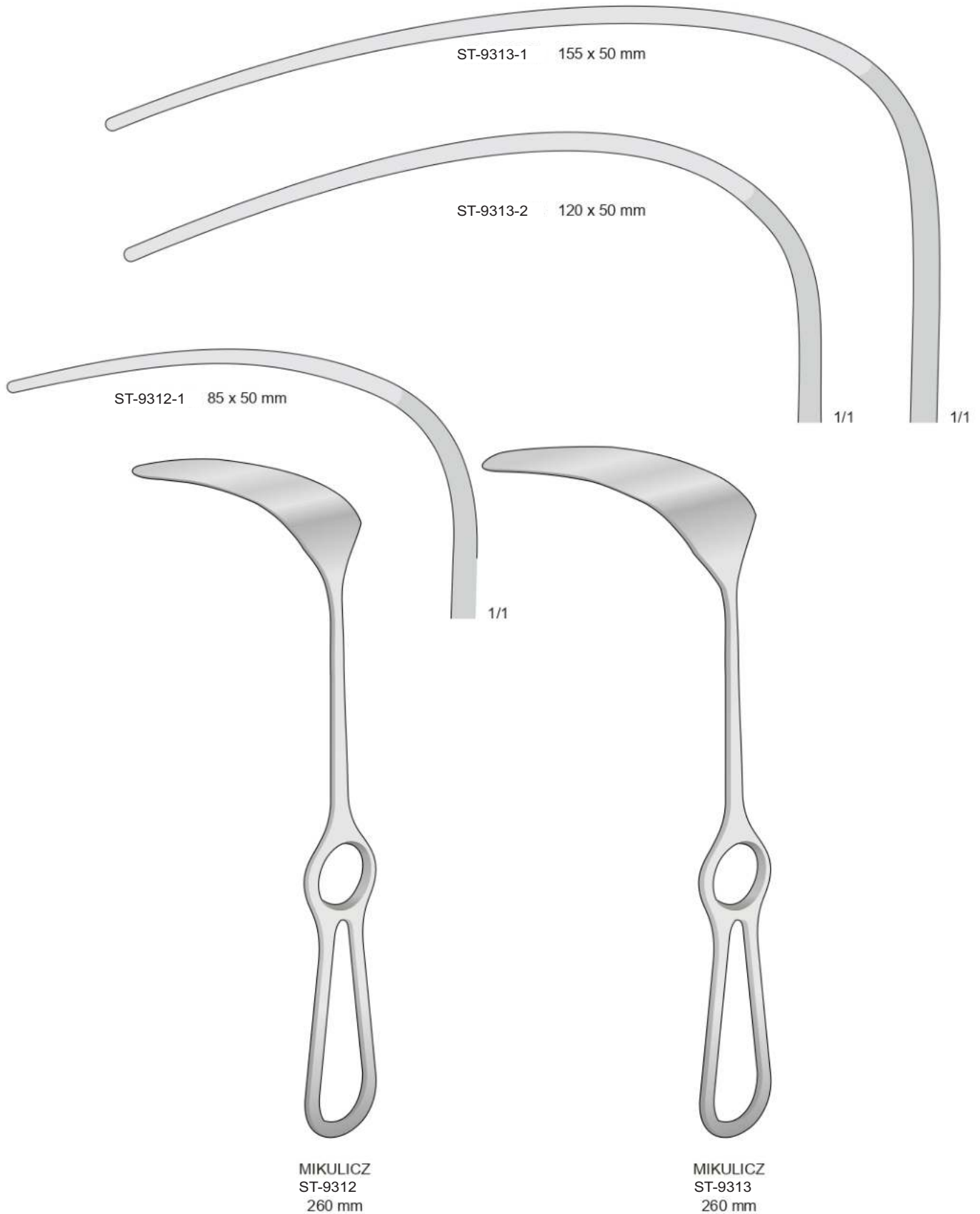


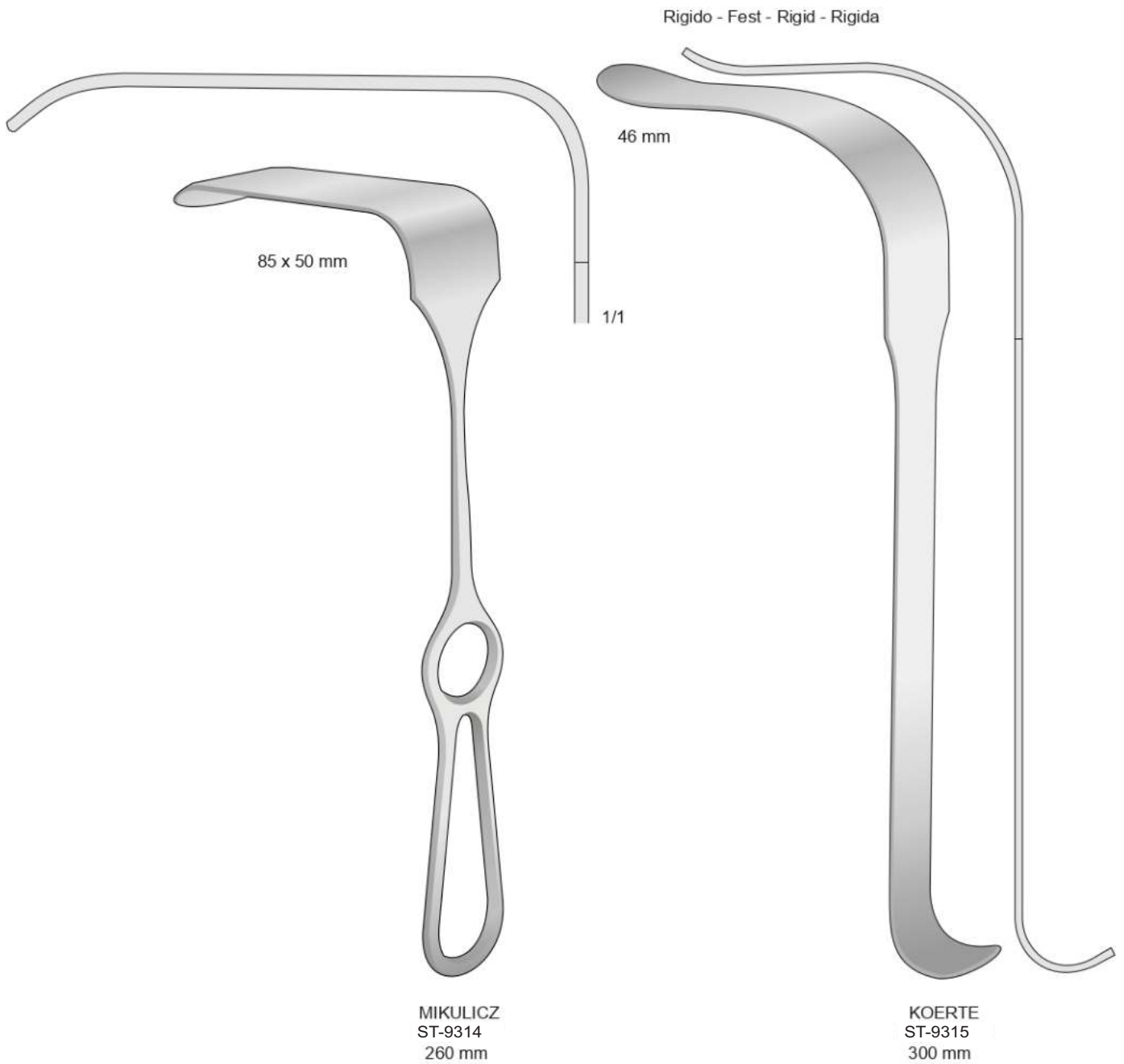
DEAVER
ST-9311-2
300 mm

75 mm



DEAVER
ST-9311-3
300 mm

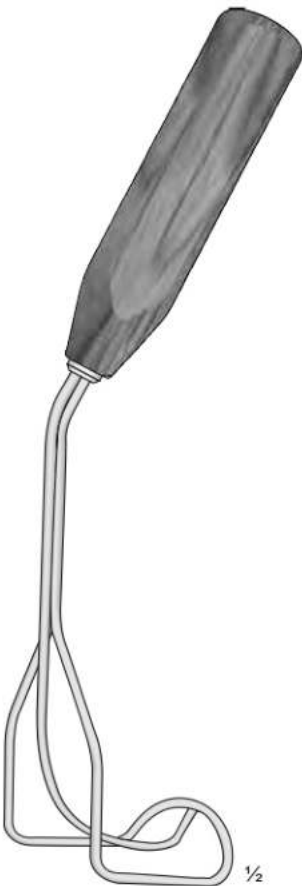






Destro
Right
Rechts
Droite
Derecha

45 mm
48 mm



COOLEY
ST-9316
215 mm

Destro, leggermente dentallato
Right, slightly serrated
Rechts, mit zahnriefen
Droite, légèrement dentelé
Derecha, legermente dentados

45 mm
48 mm



COOLEY
ST-9317
215 mm

Sinistro
Left
Links
Gauche
Izquierda

24 mm
48 mm



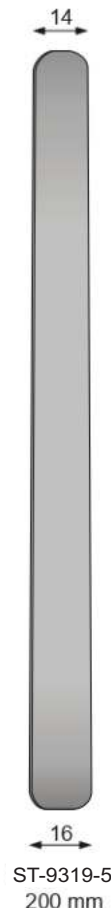
COOLEY
ST-9318
230 mm

Set completo con 3 spatole
Set complete with 3 spatulas
Kompletset mit 3 Spatel
Set complete avec 3 spatules
Set completos con 3 espatulas

Spatole addominali e intestinali inox
Abdominal and intestinal spatulas
Bauch und Darmspatel
Ecarteurs abdominaux et intestinaux
Espátulas abdominales e intestinales

Malleabili - Malleable - Biegsam
Souples - Maleables

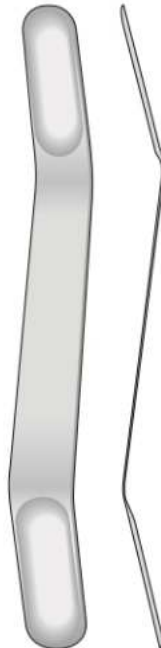
Spatole Inox malleabili antiriflesso nere
Spatulas malleable black anodized





ST-9320-1	7 mm + 9 mm
ST-9320-2	11 mm + 13 mm
ST-9320-3	15 mm + 18 mm
ST-9320-4	18 mm + 22 mm

CUSHING
ST-9320
180 mm



ST-9321-1	7 mm + 9 mm
ST-9321-2	11 mm + 13 mm
ST-9321-3	15 mm + 18 mm
ST-9321-4	18 mm + 22 mm

OLIVECRONA
ST-9321
180 mm

Malleabile - Malleable
Biegsam - Souple - Maleable



ST-9322-1 30 mm
ST-9322-2 40 mm
ST-9322-3 50 mm
330 mm

Malleabile - Malleable
Biegsam - Souple - Maleable



HABERER
ST-9323
300 mm

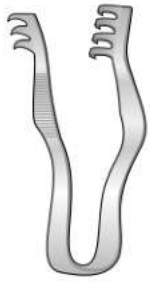


REVERDIN
ST-9324
285 mm

Malleabile - Malleable
Biegsam - Souple - Maleable



TUFFIER
ST-9325
200 mm



FINSEN
ST-9326
50 mm

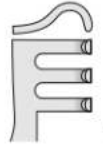
Acuto
Sharp
Spitz
Pointu
Agudas



ST-9326-1

1/1

Smusso
Blunt
Stumpf
Mousse
Romas



ST-9326-2

1/1

Acuto
Sharp
Spitz
Pointu
Agudas



ST-9326-3

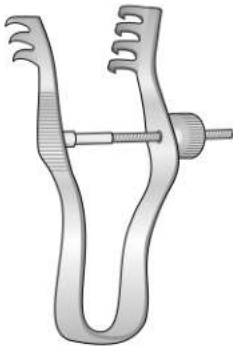
1/1

Smusso
Blunt
Stumpf
Mousse
Romas



ST-9326-4

1/1



FINSEN
ST-9327
70 mm

Acuto
Sharp
Spitz
Pointu
Agudas



ST-9327-1

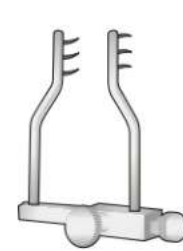
1/1

Smusso
Blunt
Stumpf
Mousse
Romas

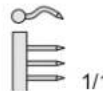


ST-9327-2

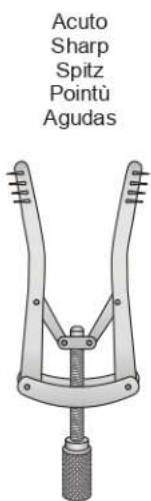
1/1



LOGAN
ST-9328
40 mm



1/1



ALM
ST-9329
70 mm

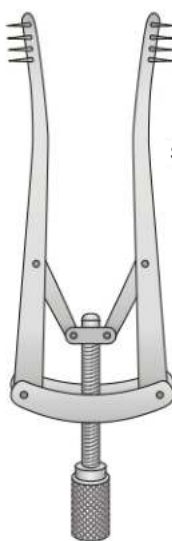
Acuto
Sharp
Spitz
Pointu
Agudas

Smusso
Blunt
Stumpf
Mousse
Romas



ST-9329-1
70 mm

1/1



ALM
ST-9330
100 mm

Acuto
Sharp
Spitz
Pointu
Agudas

Smusso
Blunt
Stumpf
Mousse
Romas

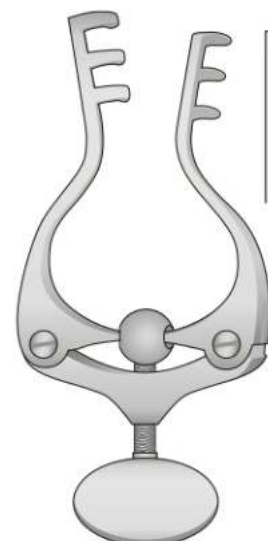


ST-9330-1
100 mm

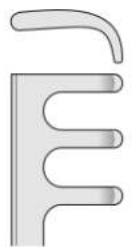
1/1



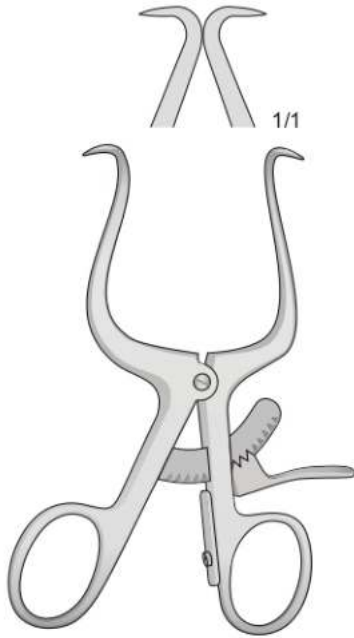
ST-9331
100 mm



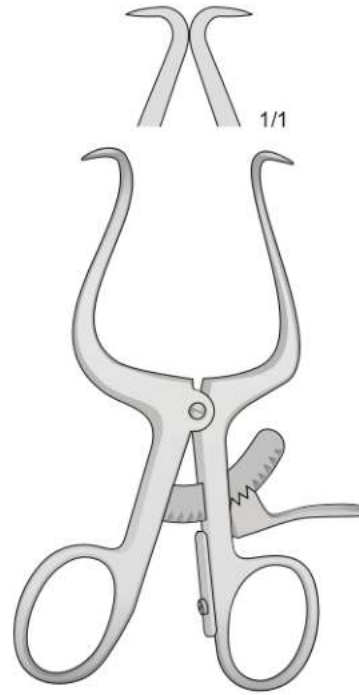
JANSEN
ST-9332
100 mm



Smusso
Blunt
Stumpf
Mousse
Romas



GELPI
ST-9333
90 mm



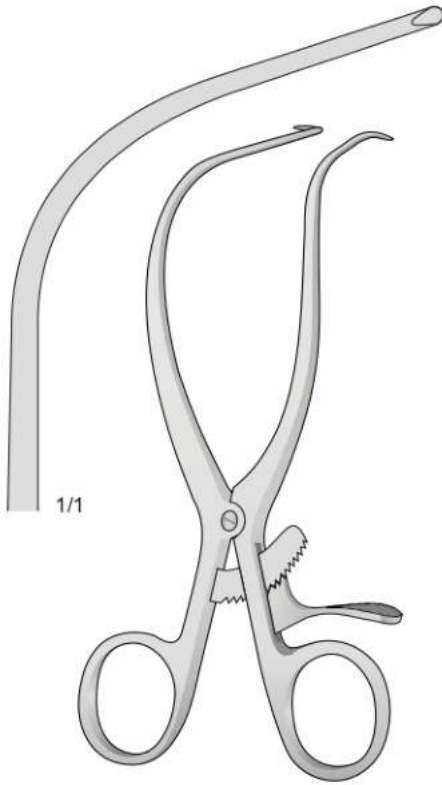
GELPI
ST-9334
110 mm



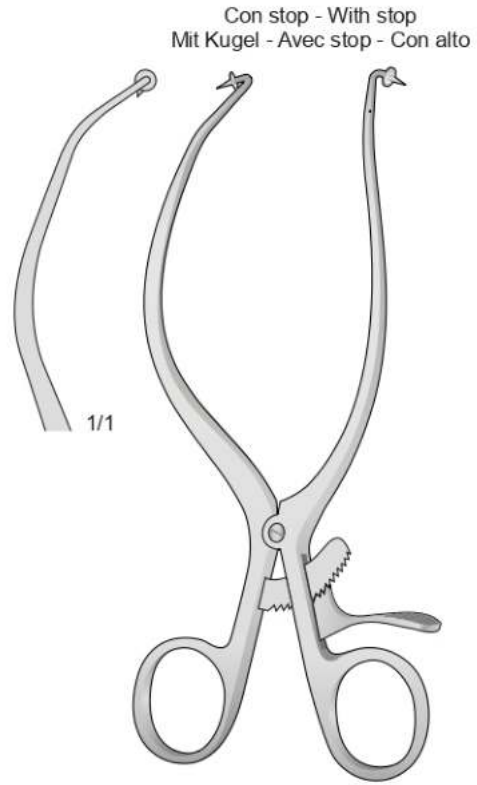
GELPI
ST-9335
140 mm



GELPI
ST-9336
180 mm

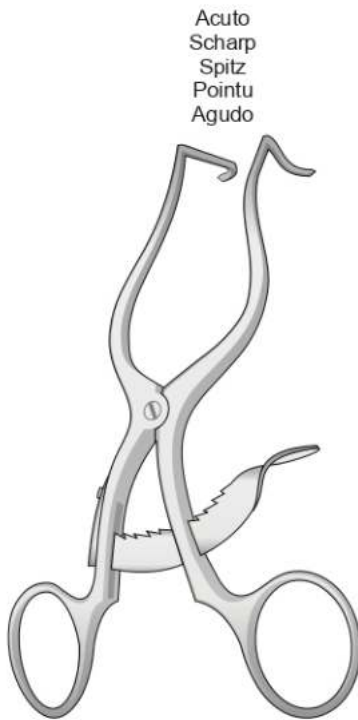


GELPI-SELETZ
ST-9337
165 mm



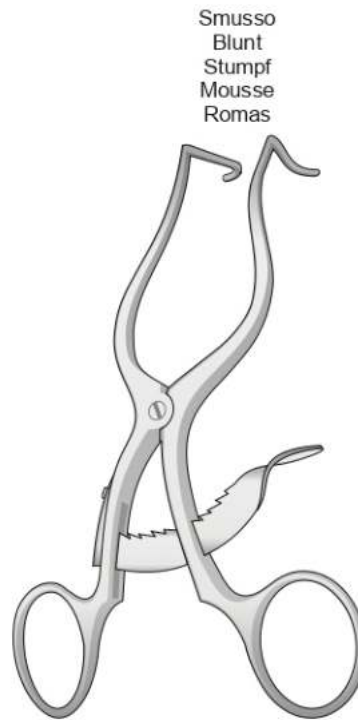
Con stop - With stop
Mit Kugel - Avec stop - Con alto

GELPI-LOKTITE
ST-9338
190 mm



Acuto
Scharp
Spitz
Pointu
Agudo

CLOWARD-CONTOUR
ST-9339
140 mm

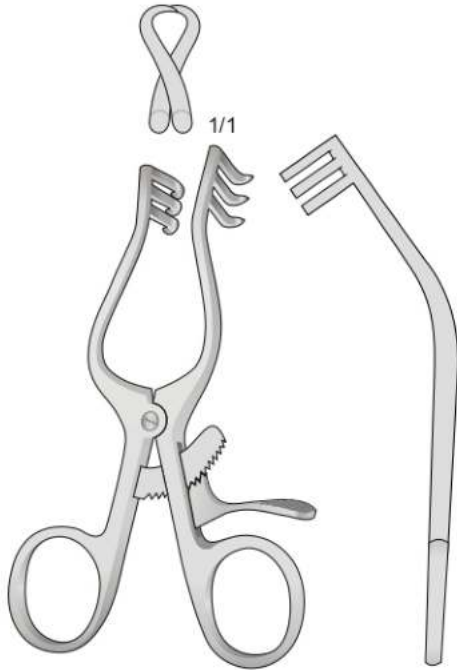


Smusso
Blunt
Stumpf
Mousse
Romos

CLOWARD-CONTOUR
ST-9340
140 mm

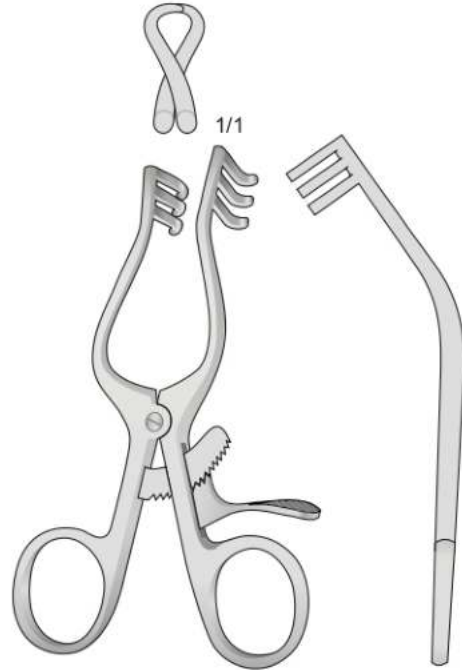


Acuto
Sharp
Spitz
Pointu
Agudo



WULLSTEIN
ST-9341
105 mm

Smusso
Blunt
Stumpf
Mousse
Romo



WULLSTEIN
ST-9342
105 mm

Acuto
Sharp
Spitz
Pointu
Agudo

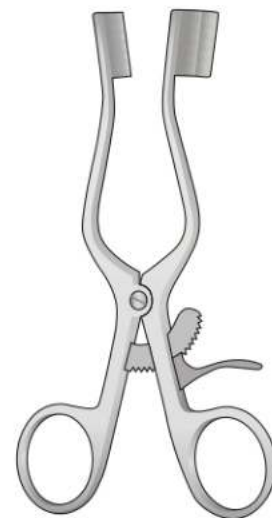


WEITLANER
ST-9343
110 mm

Smusso
Blunt
Stumpf
Mousse
Romo



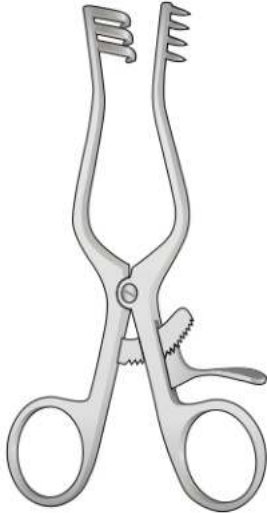
WEITLANER
ST-9344
110 mm



BABY-WEITLANER
ST-9345
140 mm

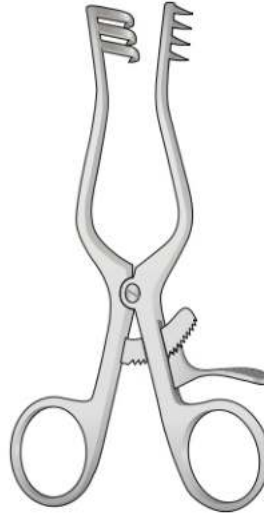


Semi acuto - Semi Sharp - Halbscharf
Semi Pointu - Semi Agudas



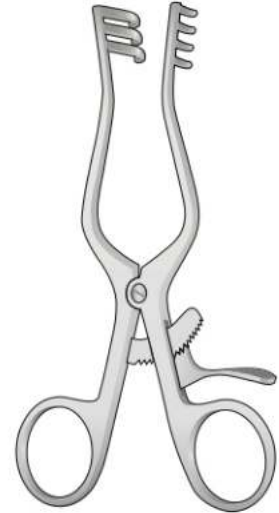
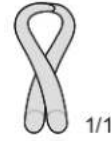
WEITLANER
ST-9346-1
135 mm

Acuto - Sharp - Spitz
Pointu - Agudas



WEITLANER
ST-9346-2
135 mm

Smusso - Blunt - Stumpf
Mousse - Romas



WEITLANER
ST-9346-3
135 mm

Acuto - Sharp - Spitz
Pointu - Agudas



WEITLANER
ST-9346-4
135 mm

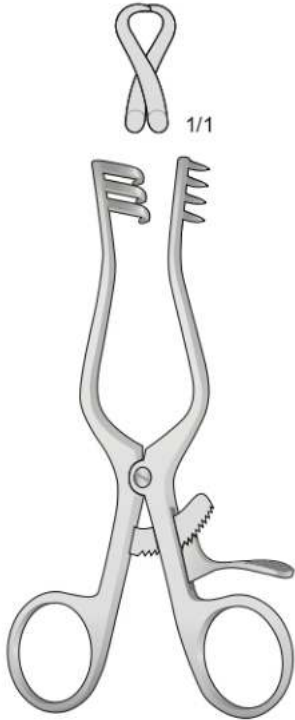
Smusso - Blunt - Stumpf
Mousse - Romas



WEITLANER
ST-9346-5
135 mm

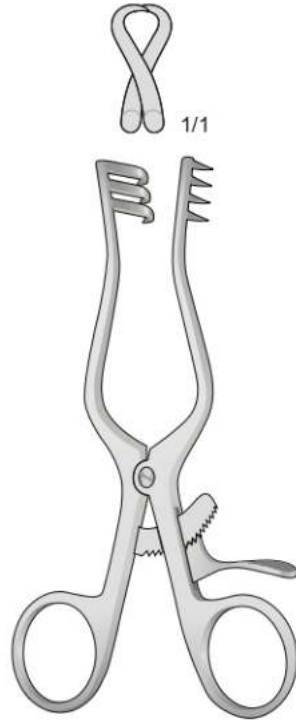


Semi acuto - Sharp - Halbscharf
Semi Pointu - Agudas



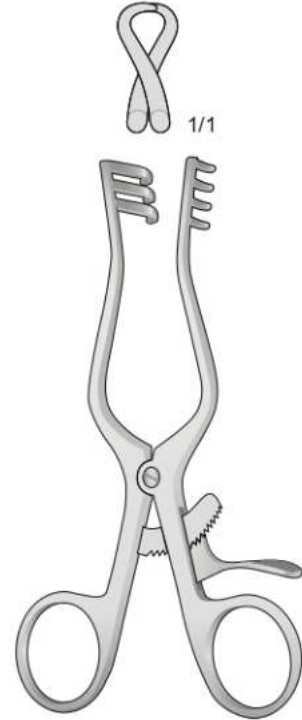
WEITLANER
ST-9347-1
165 mm

Acuto - Sharp - Spitz
Pointu - Agudas



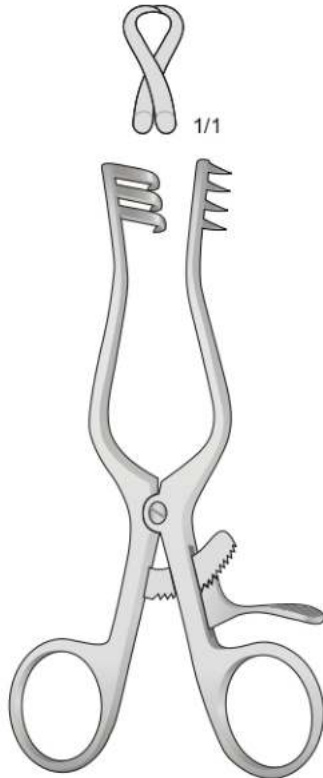
WEITLANER
ST-9347-2
165 mm

Smusso - Blunt - Stumpf
Mousse - Romas



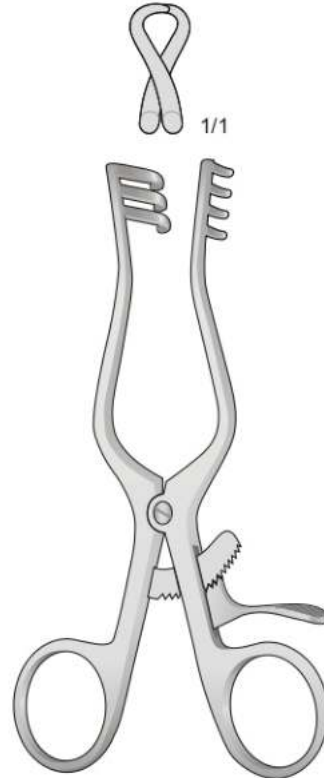
WEITLANER
ST-9347-3
165 mm

Acuto - Sharp - Spitz
Pointu - Agudas



WEITLANER
ST-9347-4
200 mm

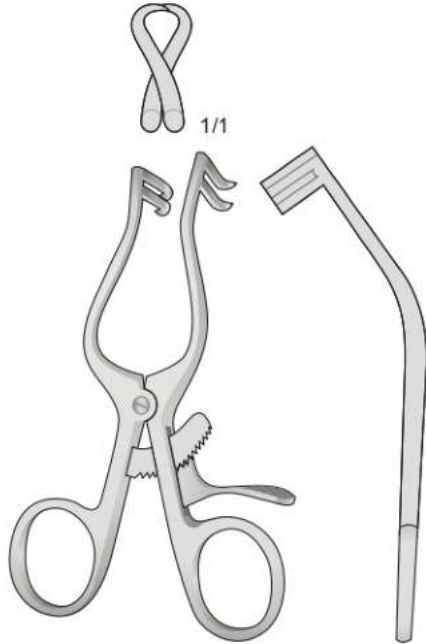
Smusso - Blunt - Stumpf
Mousse - Romas



WEITLANER
ST-9347-5
200 mm

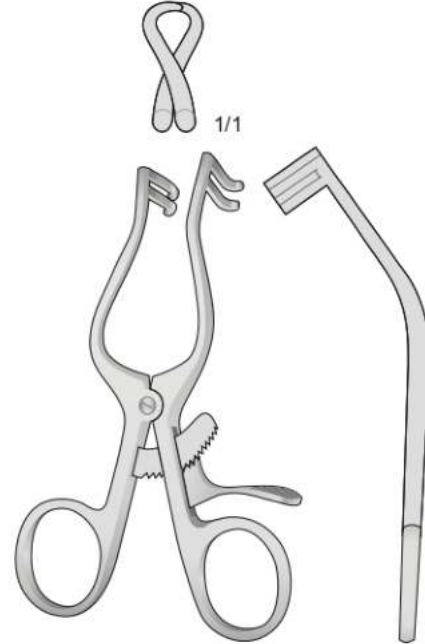


Acuto - Sharp - Spitz
Pointu - Agudas



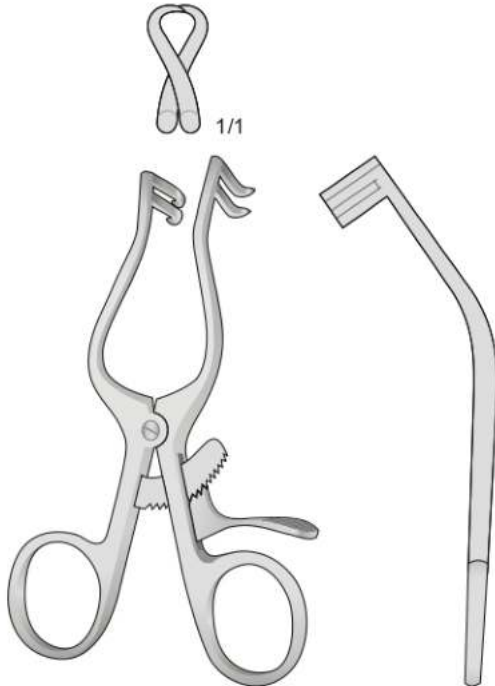
PLESTER
ST-9348
110 mm

Smusso - Blunt - Stumpf
Mousse - Romas



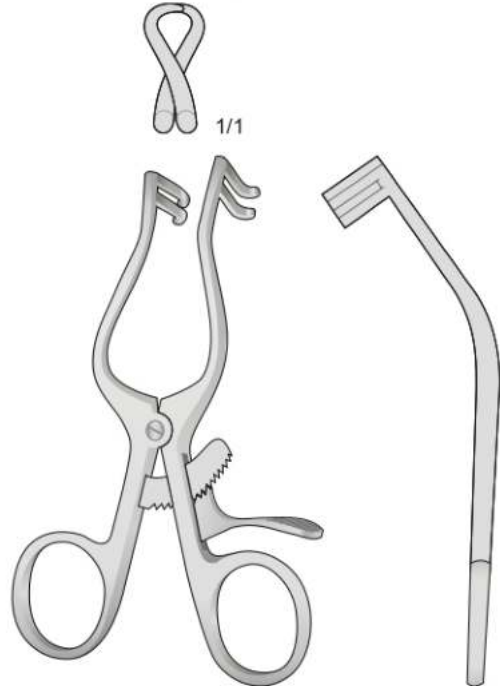
PLESTER
ST-9348
110 mm

Acuto - Sharp - Spitz
Pointu - Agudas



PLESTER
ST-9350
135 mm

Smusso - Blunt - Stumpf
Mousse - Romas



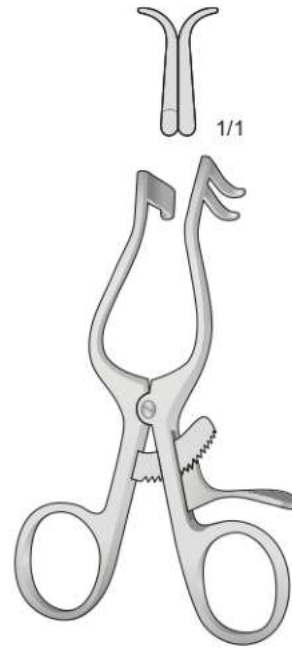
PLESTER
ST-9351
135 mm



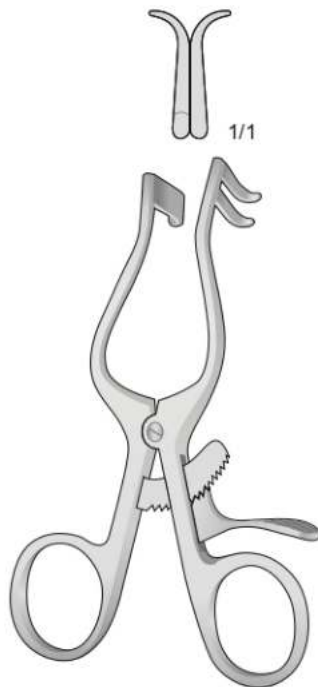
Smusso - Blunt - Stumpf - Mousse - Rome



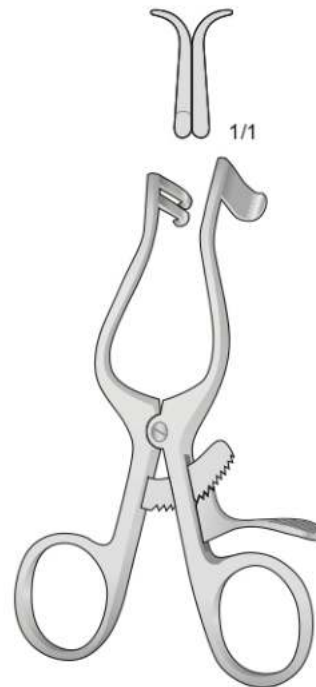
PLESTER
ST-9352-1
110 mm



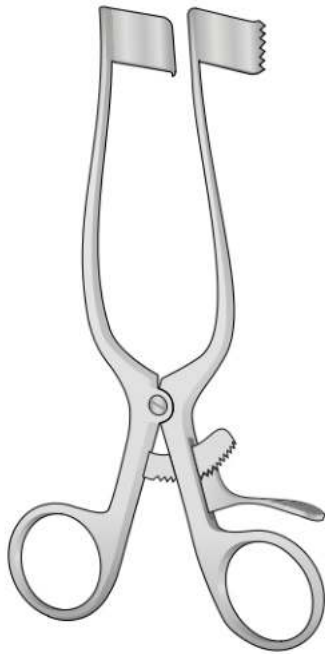
PLESTER
ST-9352-2
110 mm



PLESTER
ST-9353-1
135 mm



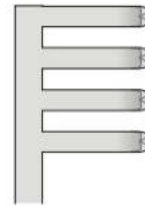
PLESTER
ST-9353-2
135 mm



MEYERDING

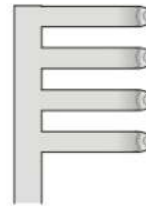
- ST-9354-1 - 32 x 25 mm
- ST-9354-2 - 60 x 25 mm
- ST-9354-3 - 54 x 25 mm
- ST-9354-4 - 60 x 20 mm
180 mm

Acuto - Sharp - Spitz
Pointu - Agudo

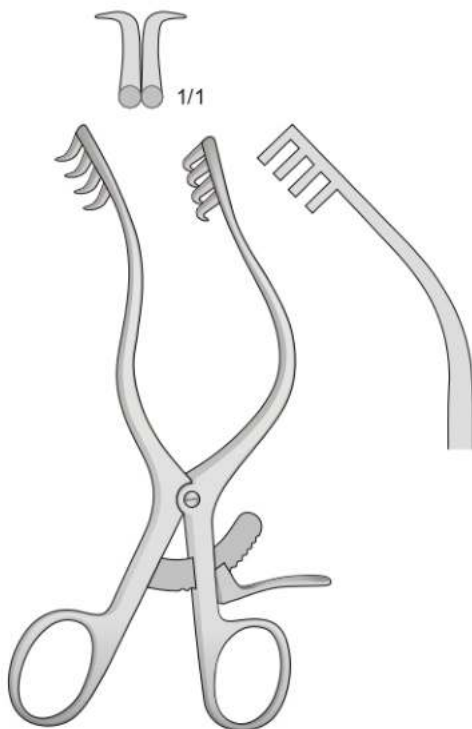


ST-9356-1

Smusso - Blunt - Stumpf
Mousse - Rome



ST-9356-2



MOLLISON
ST-9355
160 mm



ANDERSON-ADSON
ST-9356
200 mm



WALTON
ST-9357
180 mm



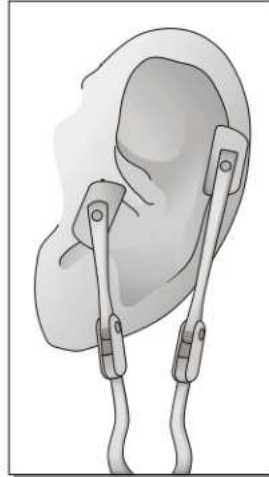
WALTON
ST-9358
180 mm



MARKHAM-MEYERDING
ST-9359
180 mm

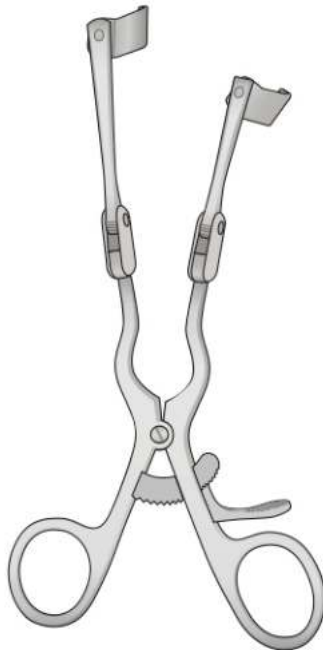


MARKHAM-MEYERDING
ST-9360
180 mm

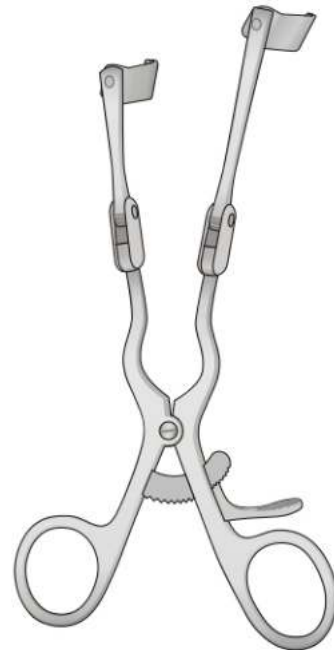


Lame, sinistro
Blades, left
Klingen, Link
Lames, gauche
Hojas, izquierda
13 x 20 mm

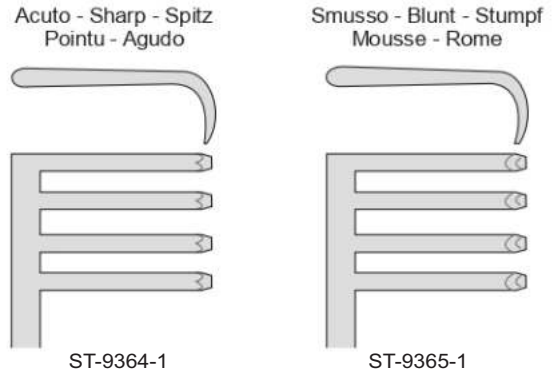
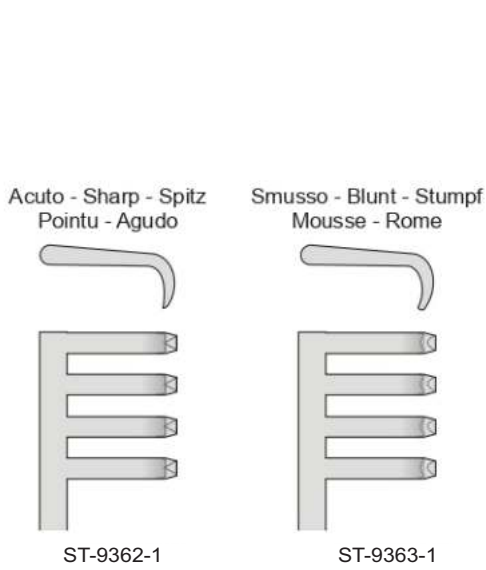
Lame, destro
Blades, right
Klingen, Rechts
Lames, droite
Hojas, derecha
13 x 20 mm



DOLWICK-REICH
ST-9361-1
170 mm

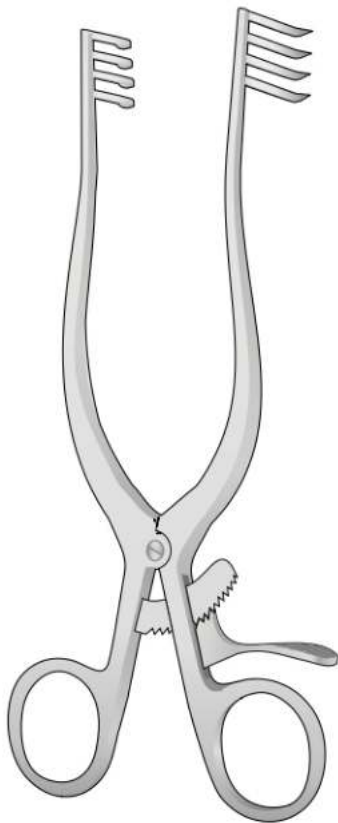


DOLWICK-REICH
ST-9361-2
170 mm

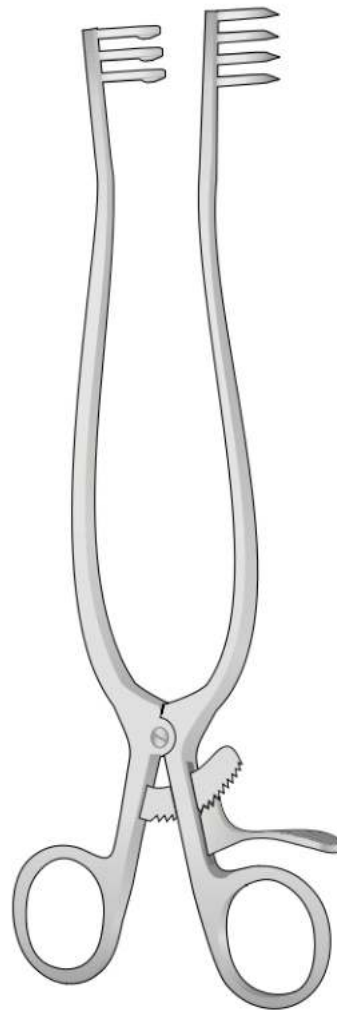


4 x 4 Denti
4 x 4 Teeth
4 x 4 Zähne
4 x 4 Dents
4 x 4 Dientes

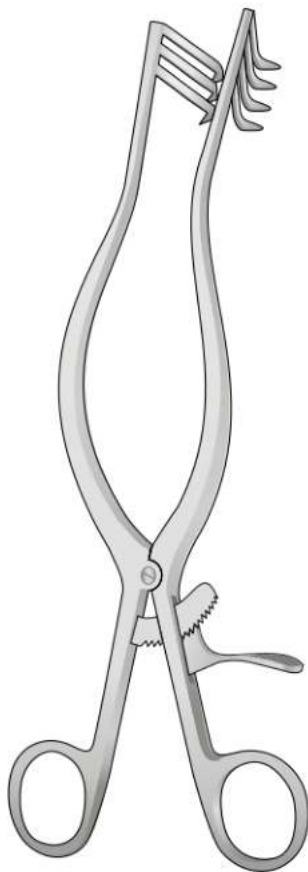
4 x 4 Denti
4 x 4 Teeth
4 x 4 Zähne
4 x 4 Dents
4 x 4 Dientes



ADSON
ST-9362 / ST-0363
200 mm

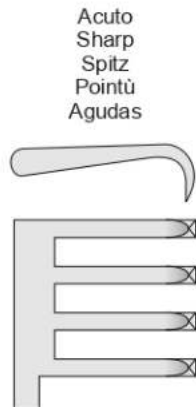


WEITLANER
ST-9364 / ST-0365
250 mm

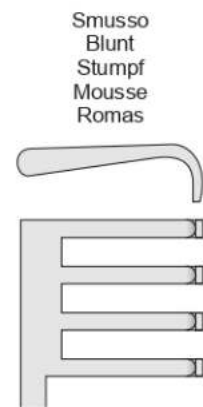


ADSON
ST-9366 / ST-9367
265 mm

3 x 4 Denti
3 x 4 Teeth
3 x 4 Zähne
3 x 4 Dents
3 x 4 Dientes

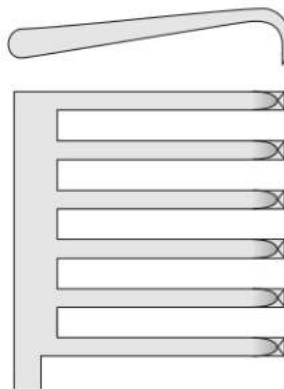


ST-9366-1

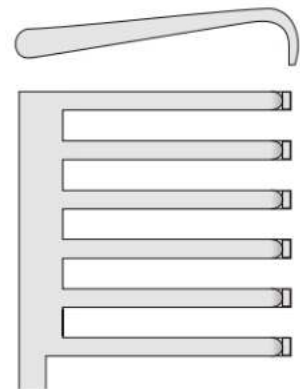


ST-9367-1

6 x 6 Denti
6 x 6 Teeth
6 x 6 Zähne
6 x 6 Dents
6 x 6 Dientes



ST-9366-2



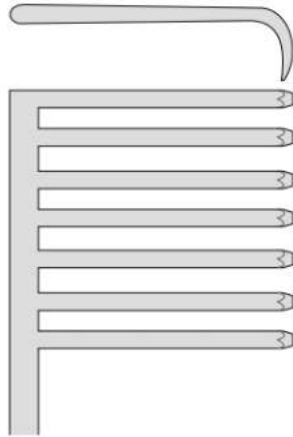
ST-9367-2

Acuto
Sharp
Spitz
Pointù
Agudas

Smusso
Blunt
Stumpf
Mousse
Romos

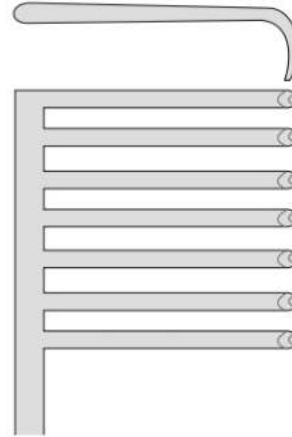


Acuto - Sharp - Spitz
Pointu - Agudo



ST-9368-1
220 mm

Smusso - Blunt - Stumpf
Mousse - Rome



ST-9369-1
220 mm

7 x 7 Denti
7 x 7 Teeth
7 x 7 Zähne
7 x 7 Dents
7 x 7 Dientes

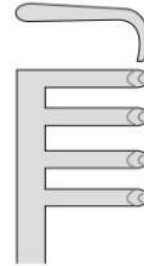
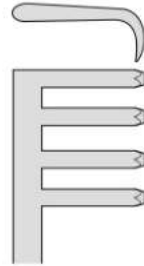


MISKIMON
ST-9368 / ST-9369
220 mm



Acuto
Scharp
Spitz
Pointu
Agudo

Smusso
Blunt
Stumpf
Mousse
Romos



ST-9370-1
140 mm

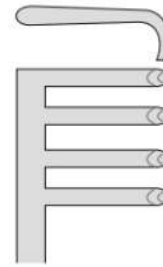
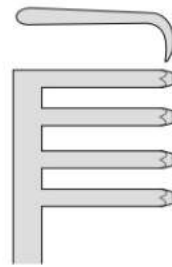
ST-9371-1
140 mm

3 x 4 Denti
3 x 4 Teeth
3 x 4 Zähne
3 x 4 Dents
3 x 4 Dientes



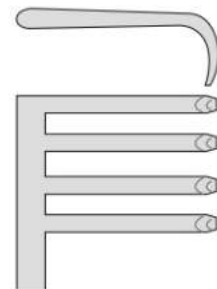
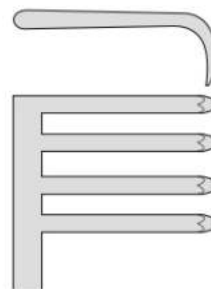
ST-9370-2
165 mm

ST-9371-2
165 mm



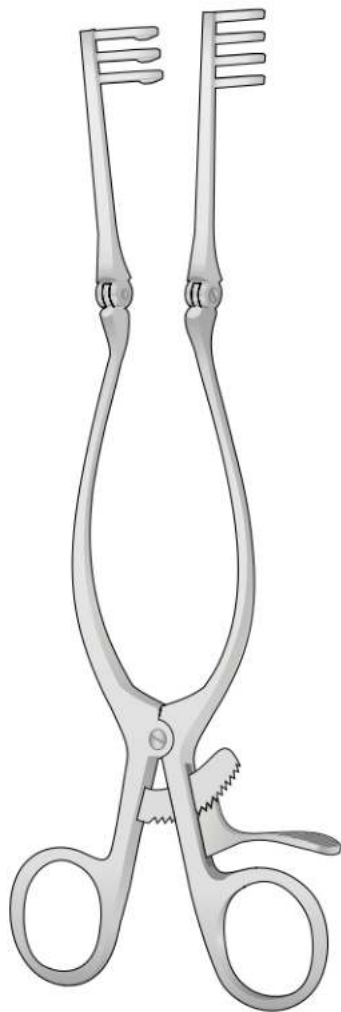
ST-9370-3
200 mm

ST-9371-3
200 mm



ST-9370-4
250 mm

ST-9371-4
250 mm

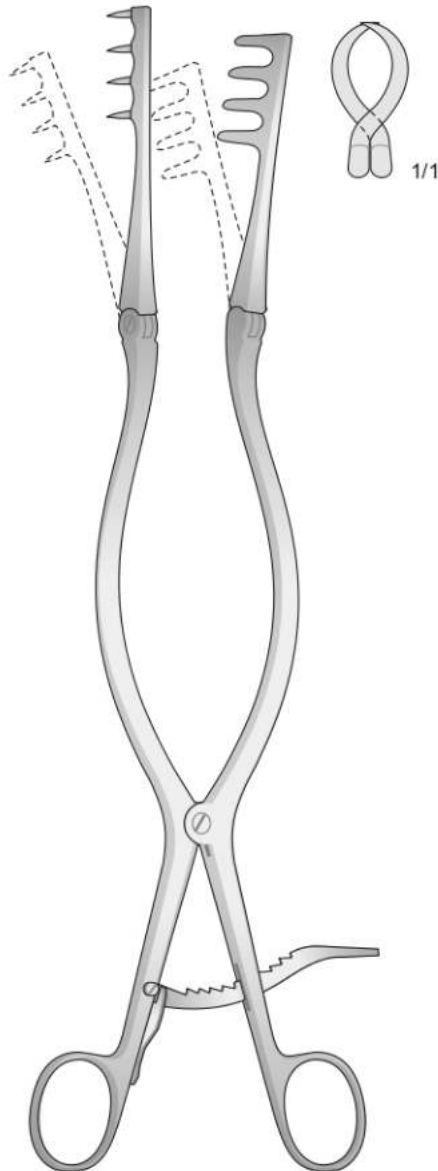


ADSON
ST-9370 / ST-9371



Acuto - Sharp
Spitz - Pointu
Agudas

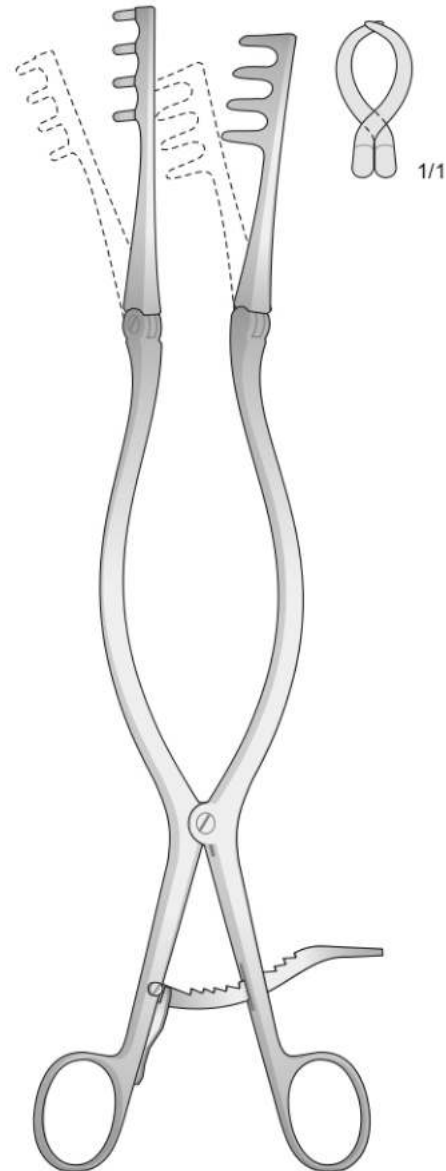
4 x 4 Denti
4 x 4 Teeth
4 x 4 Zähne
4 x 4 Dents
4 x 4 Dientes



BECKMANN
ST-9372-1
310 mm

Semi acuto -Sharp
Halbscharf - Semi pointu
Agudas

4 x 4 Denti
4 x 4 Teeth
4 x 4 Zähne
4 x 4 Dents
4 x 4 Dientes

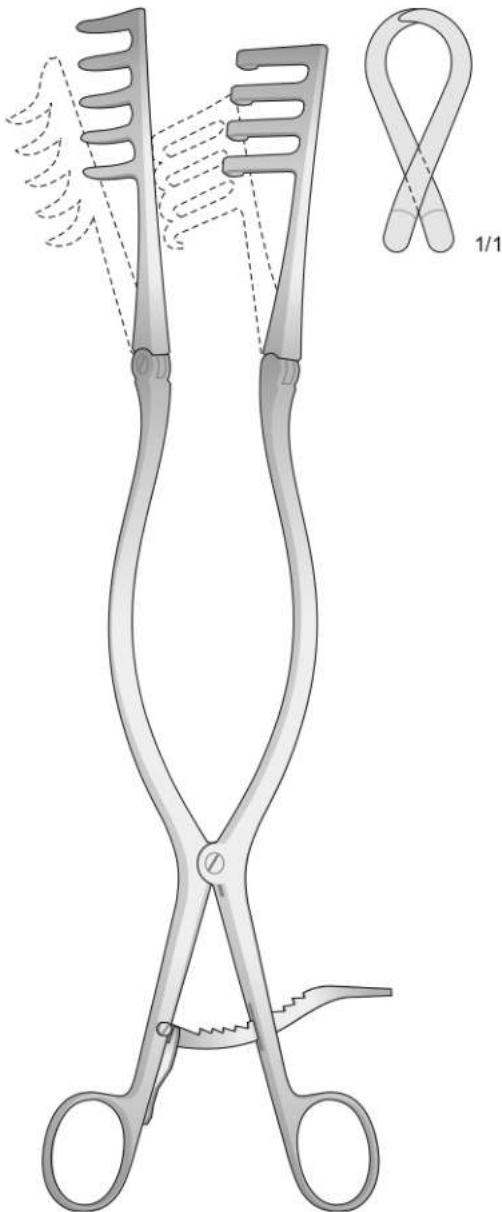


BECKMANN
ST-9372-2
310 mm



Smusso - Blunt - Stumpf
Mousse - Romas

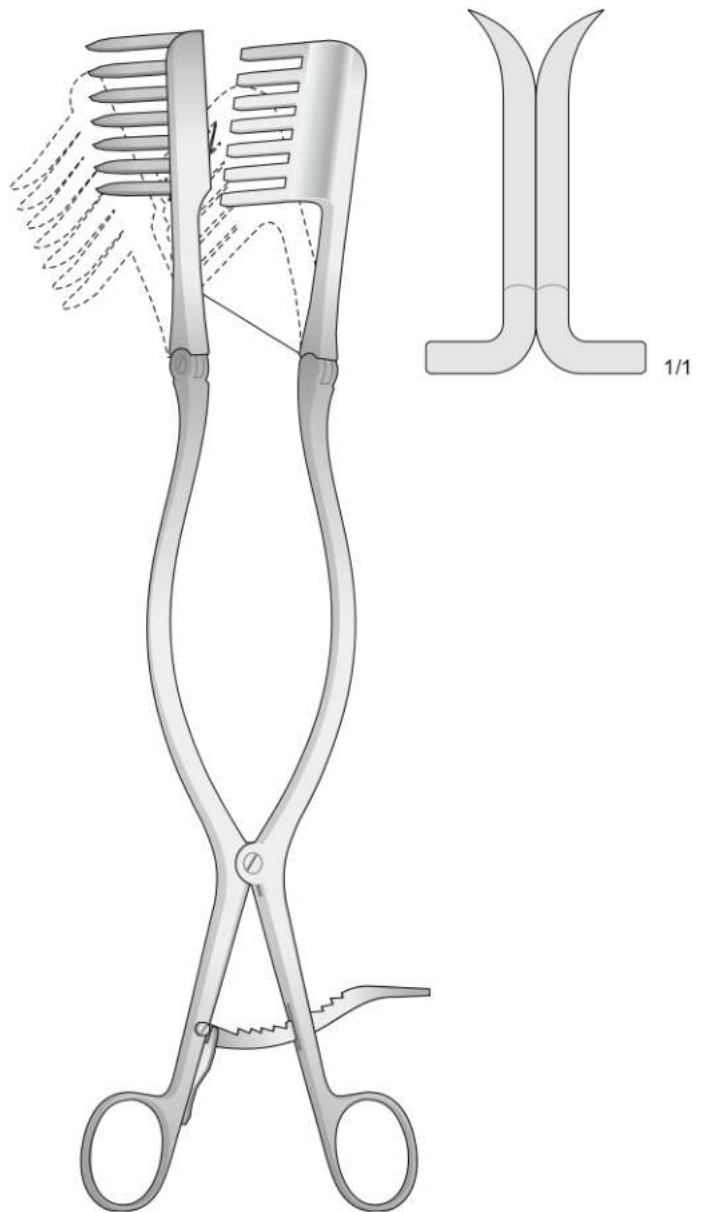
5 x 4 Denti
5 x 4 Teeth
5 x 4 Zähne
5 x 4 Dents
5 x 4 Dientes



ADSON
ST-9373
320 mm

Acuto-Sharp-Spitz
Pointú-Agudas

7 x 7 Denti
7 x 7 Teeth
7 x 7 Zähne
7 x 7 Dents
7 x 7 Dientes



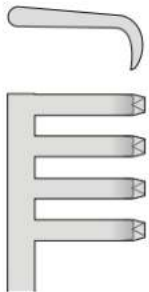
BECKMANN-EATON
ST-9374
330 mm



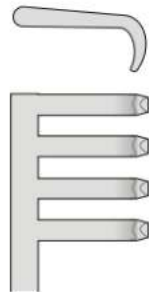
Solo divaricatore senza valva
Retractor without blades
Spreizer allein
Separador sin valvas
Ecarteur sans valves

Acuto
Sharp
Spitz
Pointù
Agudas

Smusso
Blunt
Stumpf
Mousse
Romos

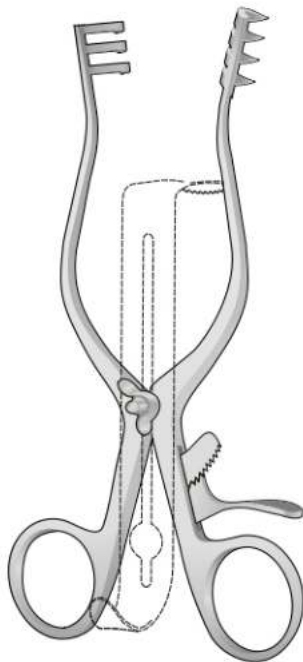


ST-9375-1



ST-9376-1

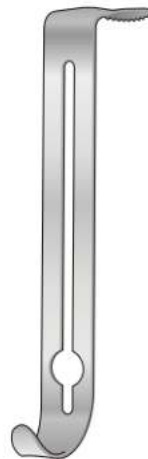
3 x 4 Denti
3 x 4 Teeth
3 x 4 Zähne
3 x 4 Dents
3 x 4 Dientes



HENLEY
ST-9375 / ST-9376
165 mm

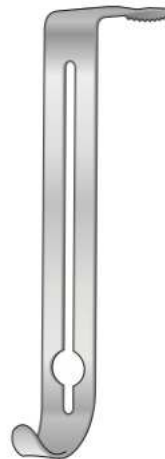
Valve centrali
Center blades
Mittelblatte
Valves centrale
Valvas centrales

Fig. 1



ST-9377-1
16x19 mm

Fig. 2



ST-9377-2
16x25 mm

Fig. 3



ST-9377-3
16x32 mm

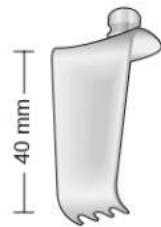


CLOWARD Modif.

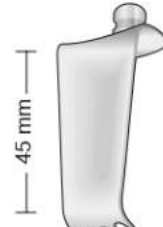
Divaricatore, solo
Retractor, only
Sperrer, allein
Ecarteur, seul
Separador, suelto

CLOWARD Modif.

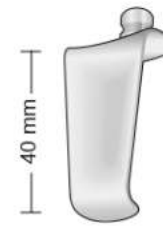
Divaricatore, solo
Retractor, only
Sperrer, allein
Ecarteur, seul
Separador, suelto



ST-9378-1



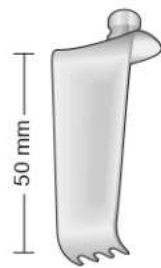
ST-9378-2



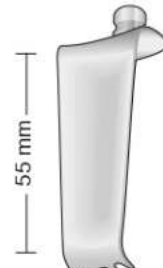
ST-9379-1



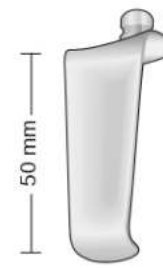
ST-9379-2



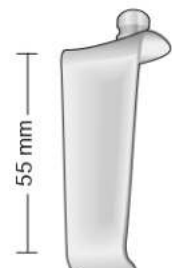
ST-9378-3



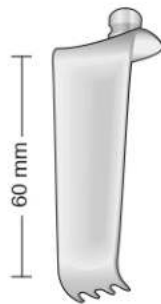
ST-9378-4



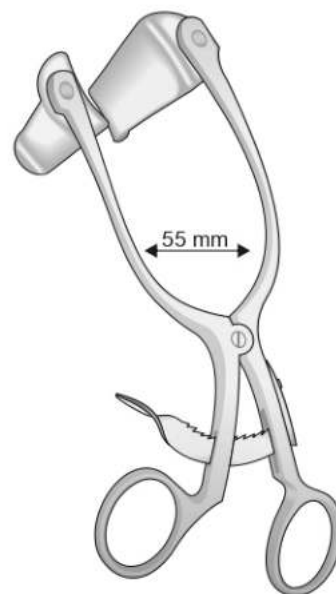
ST-9379-3



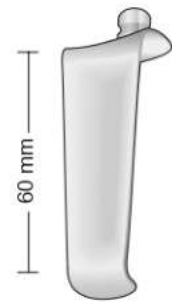
ST-9379-4



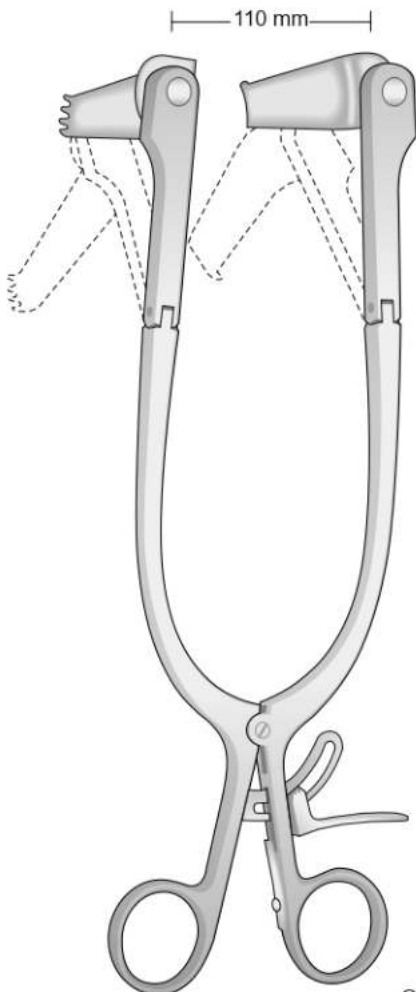
ST-9378-5



CLOWARD
ST-9379
160 mm



ST-9379-5



CLOWARD modif.
ST-9378
250 mm

Completo di 5 valve
Complete with 5 blades
Komplett mit 5 Valven
Complet avec 5 valves
Completo con 5 valvas

Completo di 5 valve
Complete with 5 blades
Komplett mit 5 Valven
Complet avec 5 valves
Completo con 5 valvas

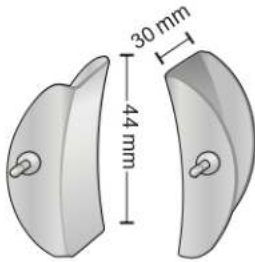


ST-9380-1

Completo con un paio di valve
Complete with 1 pairs of blades
Komplett mit 1 Paar Valven
Complete avec 1 paires de valves
Completo con 1 pares de valvas

ST-9380-2

Completo con due paia di valve
Complete with 2 pairs of blades
Komplett mit 2 paar valven
Complete avec 2 paires de valves
Completo con 2 pares de valvas



ST-9380-1 20x44 mm
ST-9380-2 30x44 mm
Valve laterali - paia
Lateral blades - pairs
Seitl. Blätter - paar
Valves latérales - paires
Valvas laterales - pares

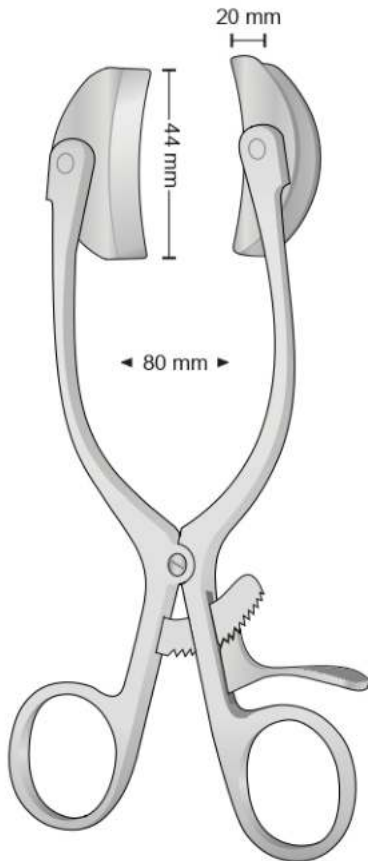
ST-9381-1

Completo con un paio di valve
Complete with 1 pairs of blades
Komplett mit 1 Paar Valven
Complete avec 1 paires de valves
Completo con 1 pares de valvas

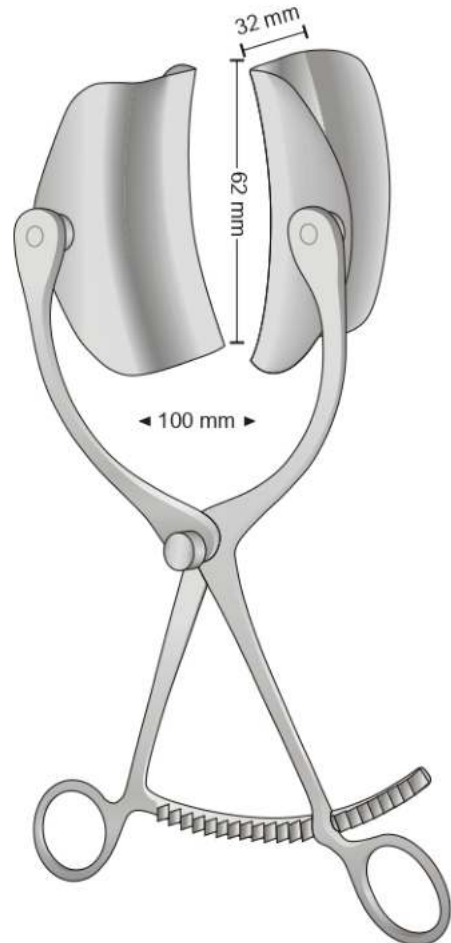
ST-9381-2
Divaricatore solo
Retractor only
Sperrer allein
Ecarteur seul
Separador suelto

ST-9381-3

32x62 mm
Valve laterali - paia
Lateral blades - pairs
Seitl.blätter - paar
Valves latérales - paires
Valvas laterales - pares



BABY-COLLIN
ST-9380
180 mm



COLLIN
ST-9381
220 mm

COLLIN
ST-9382
Completo - Complete
Komplett - Complets - Completos
09-1850-01-1850-02-1850-03

COLLIN
ST-9383
Completo - Complete
Komplett - Complets - Completos
09-1860-01-1860-02-1860-03

COLLIN
ST-9384
Completo - Complete
Komplett - Complets - Completos
09-1870-01-1870-02-1870-03

ST-9382-1
Allargatore solo
Spreader only
Sperrer allein
Ecarteur seul
Separador suelto

ST-9383-1
Allargatore solo
Spreader only
Sperrer allein
Ecarteur seul
Separador suelto

ST-9384-1
Allargatore solo
Spreader only
Sperrer allein
Ecarteur seul
Separador suelto

ST-9382-2
Valva centrale
Center blade
Mittelblatt
Valve centrale
Valva central
55 x 55 mm

ST-9383-2
Valva centrale
Center blade
Mittelblatt
Valve centrale
Valva central
55 x 65 mm

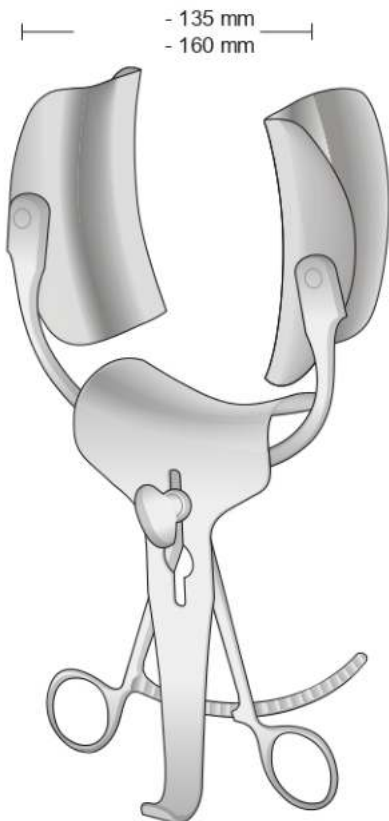
ST-9384-2
Valva centrale
Center blade
Mittelblatt
Valve centrale
Valva central
55 x 75 mm

ST-9382-3
Valve laterali
Lateral blades
Seitliche Blätter
Valves latérales
Valvas laterales
32 x 62 mm

ST-9383-3
Valve laterali
Lateral blade
Seitliche Blätter
Valves latérales
Valvas laterales
38 x 80 mm

ST-9384-3
Valve laterali
Lateral blade
Seitliche Blätter
Valves latérales
Valvas laterales
38 x 100 mm

Completo - Complete
Komplett - Complets - Completos



Unità di vendita delle valve: paio
Sales Unit of blades: pair
Bestelleinheit der Blätter: Paar
Unité de commande pour les valves: paire

COLLIN
ST-9382 / ST-9383 / ST-9384



COLLIN
ST-9385
Completo - Complete
Komplett - Complets - Completos
ST-9385-1 / ST-9385-2 / ST-9385-3

COLLIN
ST-9386
Completo - Complete
Komplett - Complets - Completos
ST-9386-1 / ST-9386-2 / ST-9386-3

ST-9385-1
Valve laterali
Lateral blades
Seitliche Blätter
Valves latérales
Valvas laterales
50 x 58 mm

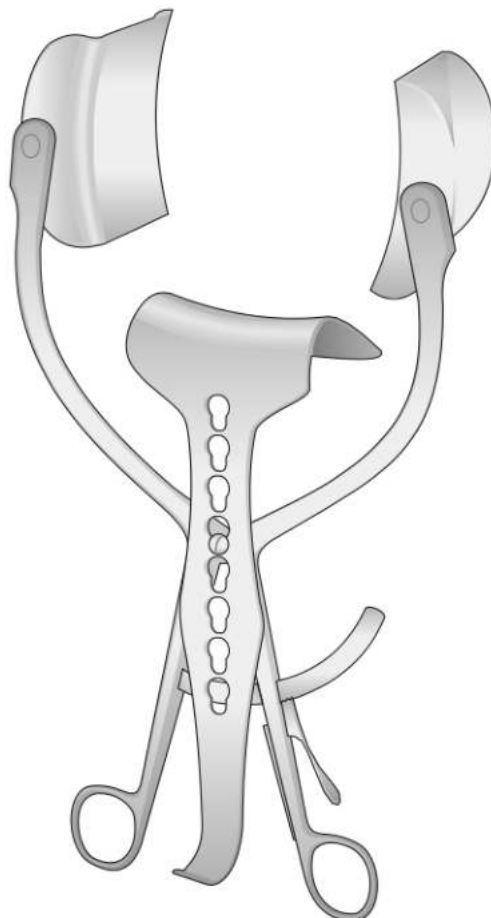
ST-9386-1
Valve laterali
Lateral blades
Seitliche Blätter
Valves latérales
Valvas laterales
62 x 80 mm

ST-9386-2
Valva centrale
Center blade
Mittelblatt
Valve centrale
Valva central
62 x 70 mm

ST-9386-3
Allargatore solo
Spreader only
Sperrer allein
Ecarteur seul
Separador suelto

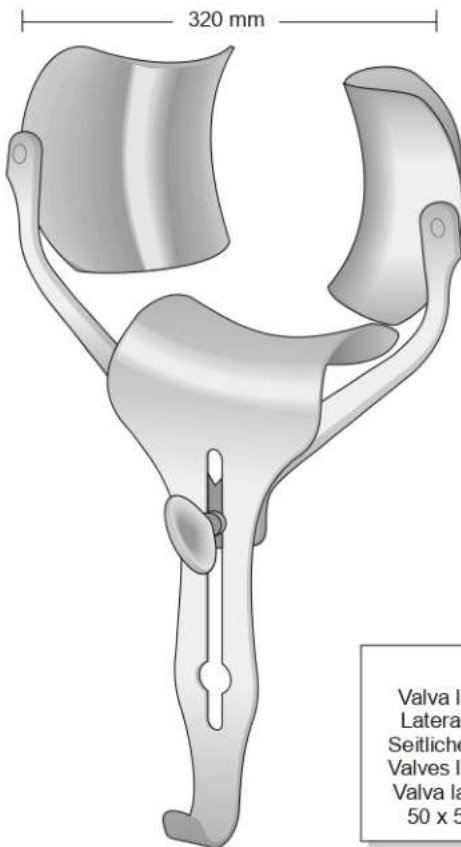
Completo - Complete
Komplett - Complets - Completos

210 mm



Unità di vendita delle valve: paio
Sales Unit of blades: pair
Bestelleinheit der Blätter: Paar
Unité de commande pour les valves: paire

COLLIN
ST-9385 / ST-9386



RICARD
ST-9387
Completo - Complete
Komplett - Complet - Completo

RICARD
ST-9388
Completo - Complete
Komplett - Complet - Completo

ST-9387-1 / ST-9388-1
Divaricatore solo
Retractor only
Sperrer allein
Ecarteur seul
Separador suelto

ST-9387-2
Valva centrale
Center blade
Mittelblatt
Valve centrale
Valva central
55 x 70 mm

ST-9388-2
Valva centrale
Center blade
Mittelblatt
Valve centrale
Valva central
80 x 90 mm

Valva laterale
Lateral blade
Seitliche Blätter
Valves latérales
Valva laterales
50 x 58 mm

ST-9387-3
Valva laterale
Lateral blade
Seitliche Blätter
Valves latérales
Valva laterales
60 x 80 mm

ST-9388-3
Valva laterale
Lateral blade
Seitliche Blätter
Valves latérales
Valva laterales
72 x 85 mm

RICARD
ST-9387
Completo - Complete
Komplett - Complet - Completo

ST-9388
Completo - Complete
Komplett - Complet - Completo

Unità di vendita delle valve: paio
Sales Unit of blades: pair
Bestelleinheit der Blätter: Paar
Unité de commande pour les valves: paire

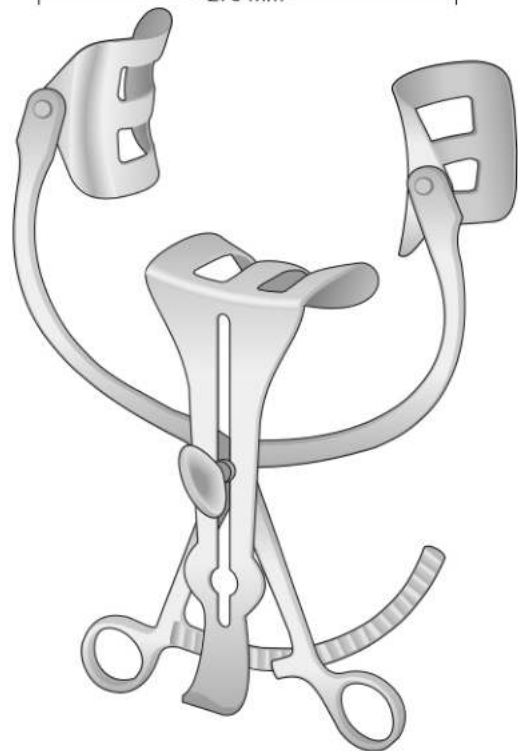
ST-9389-1
Divaricatore solo
Retractor only
Sperrer allein
Ecarteur seul
Separador suelto

ST-9389-2
59 x 80 mm
Valve laterali
Lateral blades
Seitliche Blätter
Valves latérales
Valvas laterales

ST-9389-3
74 x 82 mm
Valva centrale
Center blade
Mittelblatt
Valve centrale
Valva central

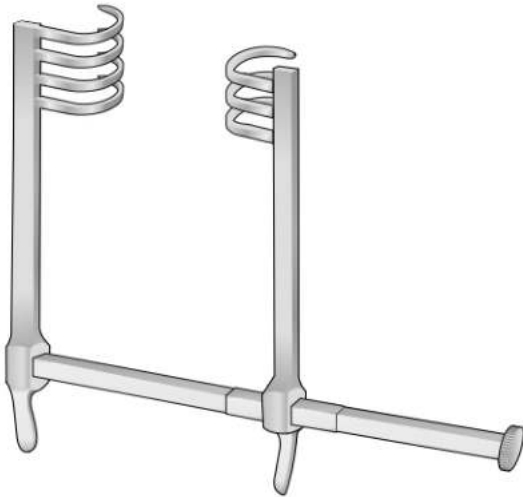
Completo - Complete
Komplett - Complete - Completos

275 mm

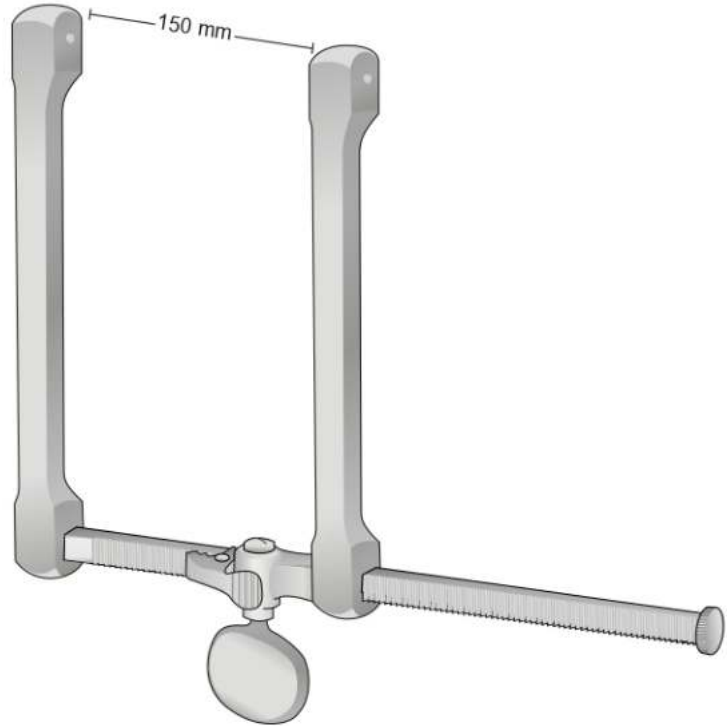


HOLZBACH
ST-9389

Strumento solo, senza valve
Frame only - Instrumente allein, ohne Blätter
Cadre seul - Cuadro solo

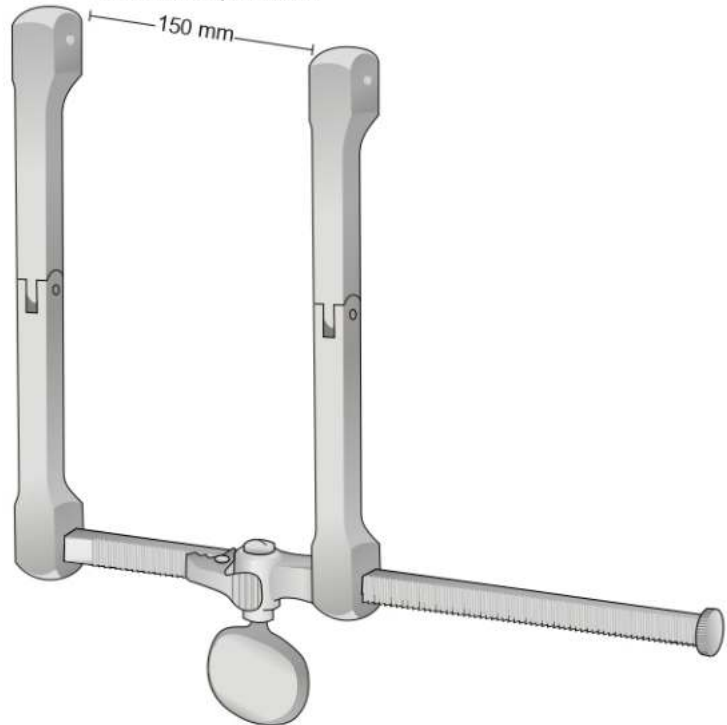


FRAZIER
ST-9390



SCOVILLE
ST-9391

Strumento solo, senza valve
Frame only, without blade
Instrumente allein, ohne Blätter
Cadre seul, sans valves
Cuadro solo, no valvas



SCOVILLE-HAVERFIELD
ST-9392



Acuto
Scharp
Spitz
Pointù
Agudo



SCOVILLE
ST-9393-1
50 mm

Acuto
Scharp
Spitz
Pointù
Agudo



SCOVILLE
ST-9393-2
70 mm

Smusso
Blunt
Stumpf
Mousse
Romo

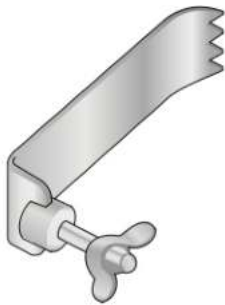


SCOVILLE
ST-9394-1
50 mm

Smusso
Blunt
Stumpf
Mousse
Romo



SCOVILLE
ST-9394-2
70 mm



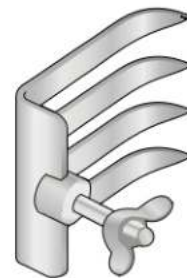
SCOVILLE

ST-9395-1	50x25 mm
ST-9395-2	50x50 mm
ST-9395-3	57x38 mm
ST-9395-4	64x25 mm
ST-9395-5	64x50 mm
ST-9395-6	67x30 mm
ST-9395-7	75x25 mm
ST-9395-8	75x50 mm
ST-9395-9	88x25 mm
ST-9395-10	100x50 mm



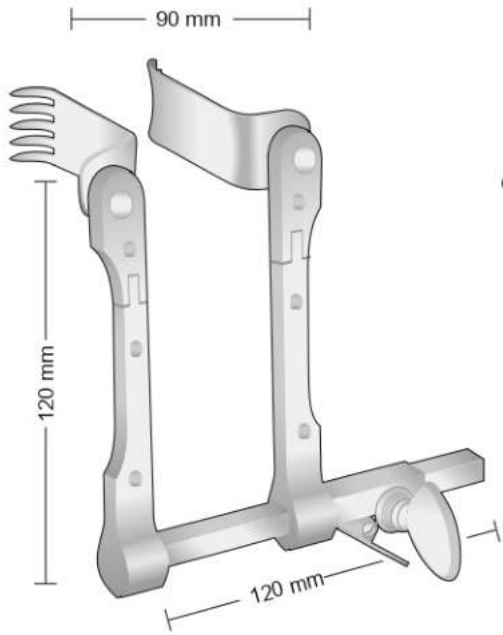
TAYLOR

ST-9396-1	48x50 mm
ST-9396-2	64x50 mm
ST-9396-3	64x64 mm
ST-9396-4	80x57 mm



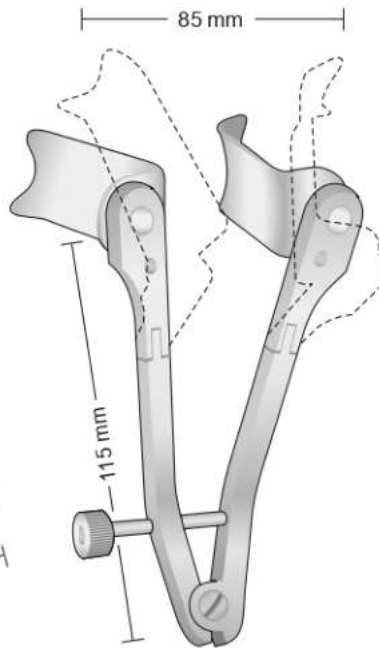
SCOVILLE

ST-9397-1	41x38 mm
ST-9397-2	67x44 mm



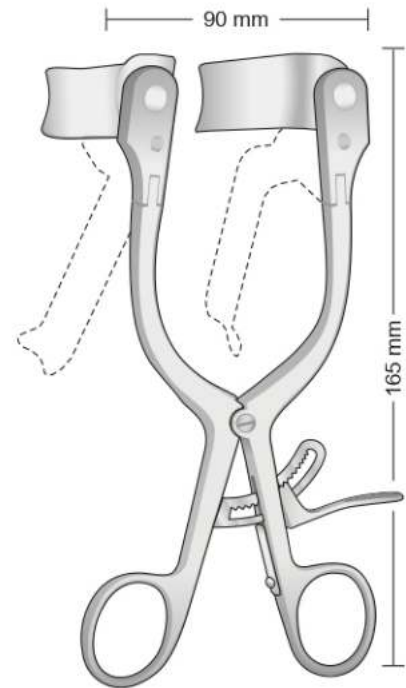
CASPAR
ST-9398-1
Completo con 5 + 5 valve
Complete with 5 + 5 blade
Komplett mit 5 + 5 Blätter
Complet avec 5 + 5 valves
Completo con 5 + 5 valvas

ST-9398-2
Divaricatore solo
Retractor only
Sperrer allein
Ecarteur seul
Separador suelto



CASPAR
ST-9399-1
Completo con 5 valve
Complete with 5 blade
Komplett mit 5 Blätter
Complet : 5 valves
Completc 5 valvas

ST-9399-2
Divaricatore solo
Retractor only
Sperrer allein
Ecarteur seul
Separador suelto



CASPAR
ST-9400-1
Completo con 5 valve
Complete with 5 blade
Komplett mit 5 Blätter
Complet avec 5 valves
Completo con 5 valvas

ST-9400-2
Divaricatore solo
Retractor only
Sperrer allein
Ecarteur seul
Separador suelto



ST-9401-1
40 x 23 mm
ST-9401-2
45 x 23 mm
ST-9401-3
50 x 23 mm
ST-9401-4
55 x 23 mm
ST-9401-5
60 x 23 mm



ST-9402-1
40 x 23 mm
ST-9402-2
45 x 23 mm
ST-9402-3
50 x 23 mm
ST-9402-4
55 x 23 mm
ST-9402-5
60 x 23 mm



ST-9403-1
45 x 23 mm
ST-9403-2
50 x 23 mm
ST-9403-3
55 x 23 mm
ST-9403-4
60 x 23 mm
ST-9403-5
65 x 23 mm



ST-9404-1
50 x 25 mm
ST-9404-2
60 x 25 mm

Valve in titanio
Titanium blades
Titan-valven
Valves en titane
Valvas in titanio



ST-9405-1	25 x 24 mm
ST-9405-2	30 x 24 mm
ST-9405-3	35 x 24 mm
ST-9405-4	40 x 24 mm
ST-9405-5	45 x 24 mm
ST-9405-6	25 x 24 mm
ST-9405-7	30 x 24 mm
ST-9405-8	35 x 24 mm
ST-9405-9	40 x 24 mm
ST-9405-10	45 x 24 mm



ST-9406-1	25 x 24 mm
ST-9406-2	30 x 24 mm
ST-9406-3	35 x 24 mm
ST-9406-4	40 x 24 mm
ST-9406-5	45 x 24 mm
ST-9406-6	50 x 24 mm
ST-9406-7	55 x 24 mm
ST-9406-8	60 x 24 mm
ST-9406-9	65 x 24 mm
ST-9406-10	70 x 24 mm

Pinzetta per la sostituzione delle valve
con i bloccaggi rapidi a sfera
Blade ejector for changing the blades
with ball snap closure
Pinzette zum wechseln der valven
mit kugelschnellverschluss
Pincettes pour changer les valves munies
du système de verrouillage rapide à billes

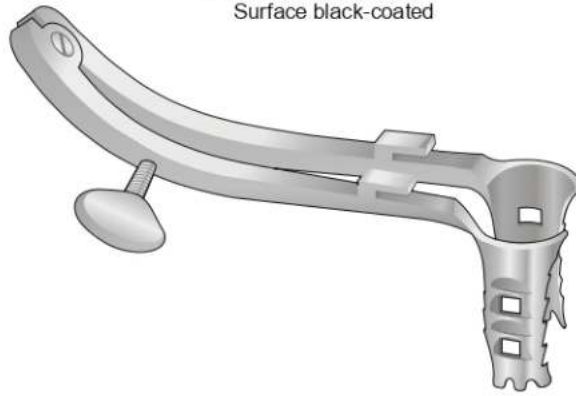


ST-9406-1	30 x 24 mm
ST-9406-2	35 x 24 mm
ST-9406-3	40 x 24 mm
ST-9406-4	45 x 24 mm
ST-9406-5	50 x 24 mm
ST-9406-6	55 x 24 mm
ST-9406-7	60 x 24 mm
ST-9406-8	65 x 24 mm
ST-9406-9	70 x 24 mm
ST-9406-10	75 x 24 mm

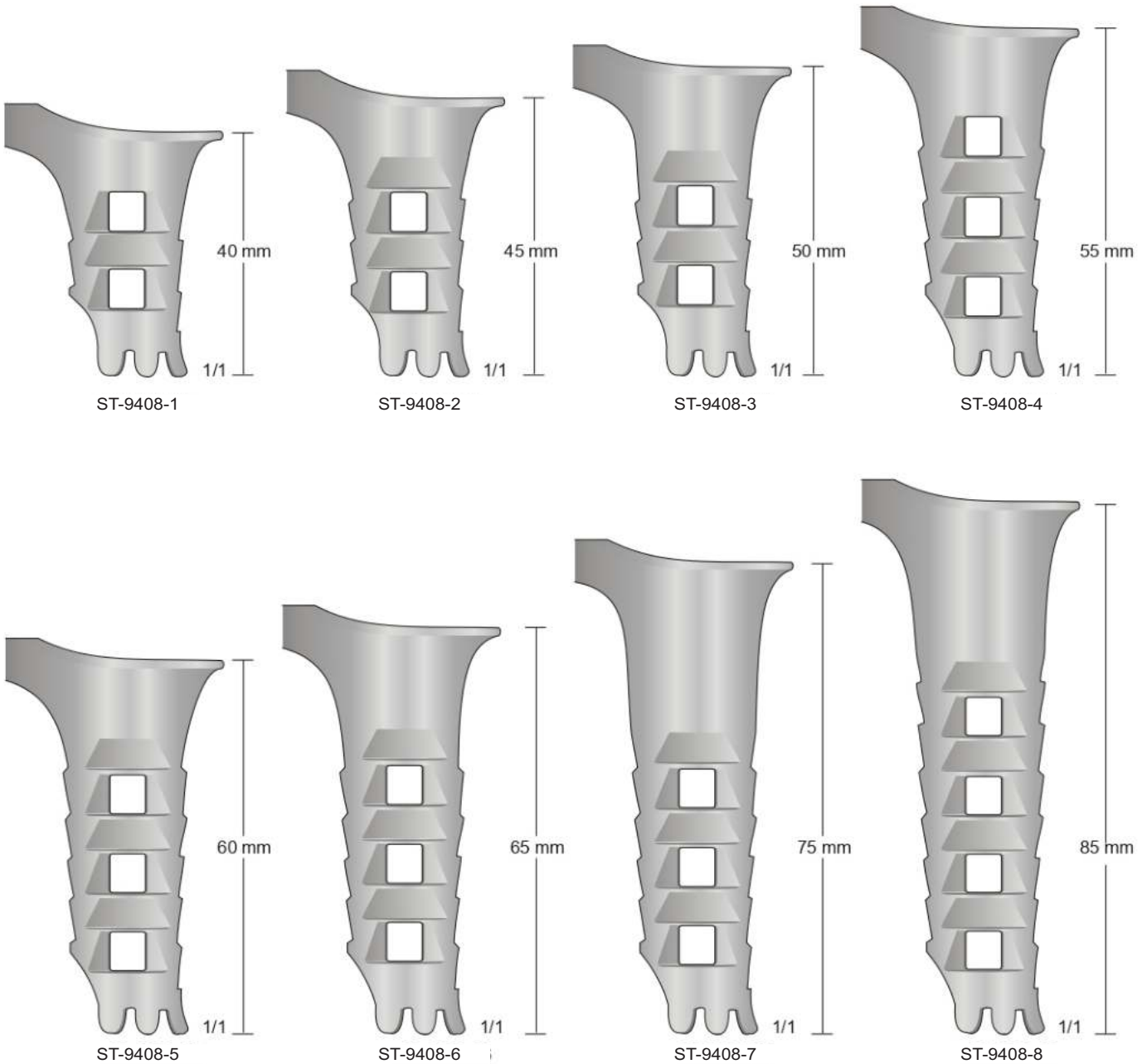


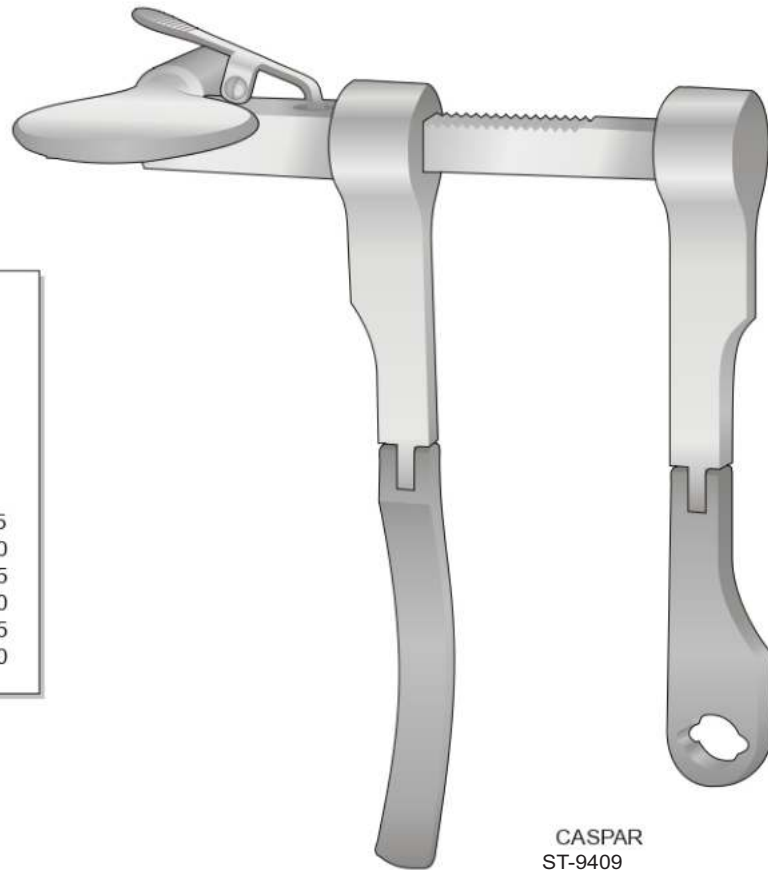
ST-9407
115 mm

Oberfläche schwarz beschichtet
Surface black-coated



CASPAR
ST-9408





**CASPAR
ST-9410**

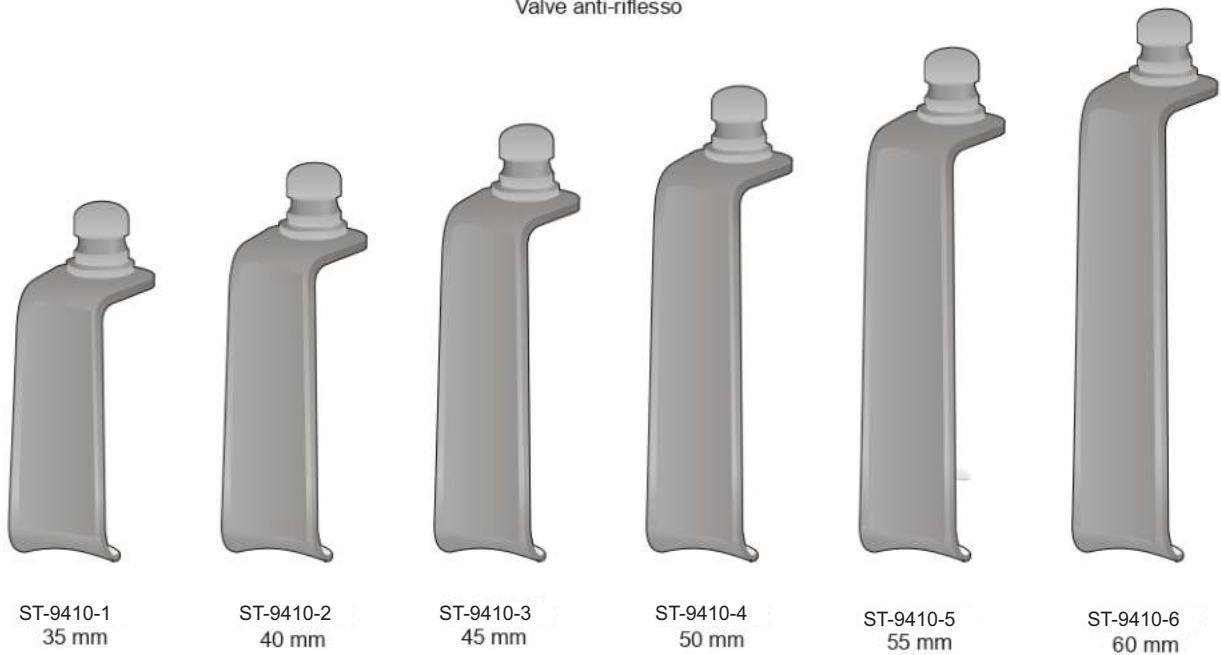
Divaricatore completo di
Retractor complete with
Sperrer komplett mit
Ecarteur complet avec
Separador completo con

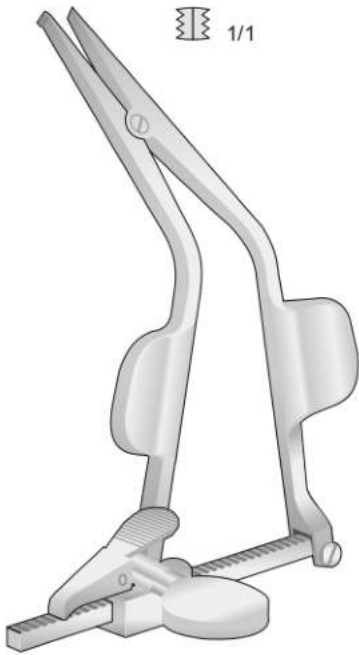
ST-9410-1	Valva anti-riflesso mm. 35
ST-9410-2	Valva anti-riflesso mm. 40
ST-9410-3	Valva anti-riflesso mm. 45
ST-9410-4	Valva anti-riflesso mm. 50
ST-9410-5	Valva anti-riflesso mm. 55
ST-9410-6	Valva anti-riflesso mm. 60

ST-9409
Divaricatore solo
Retractor only
Sperrer allein
Ecarteur seul
Separador suelto

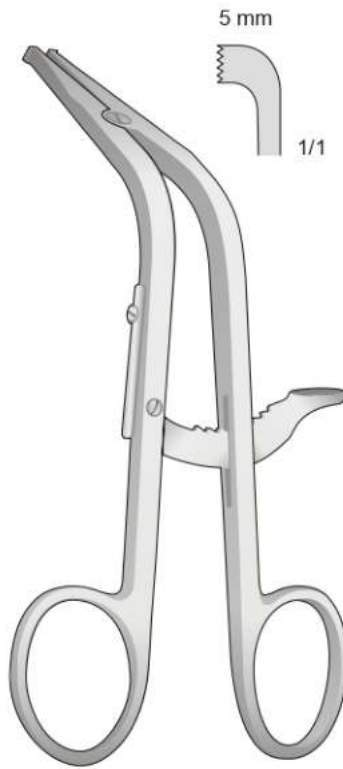
**CASPAR
ST-9409**

Valve anti-riflesso

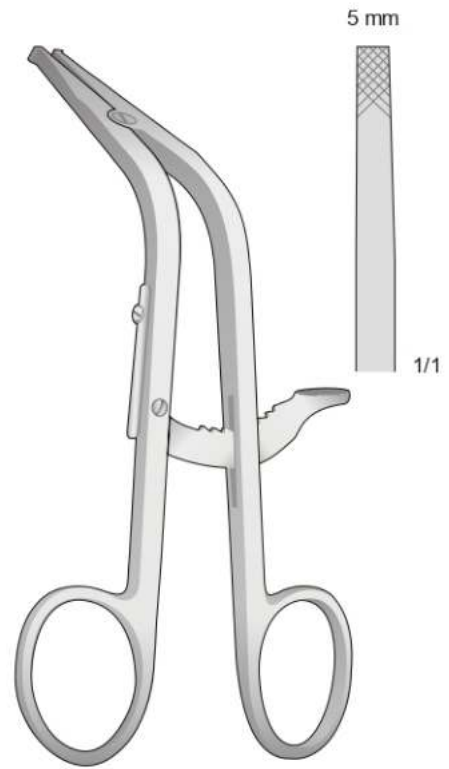




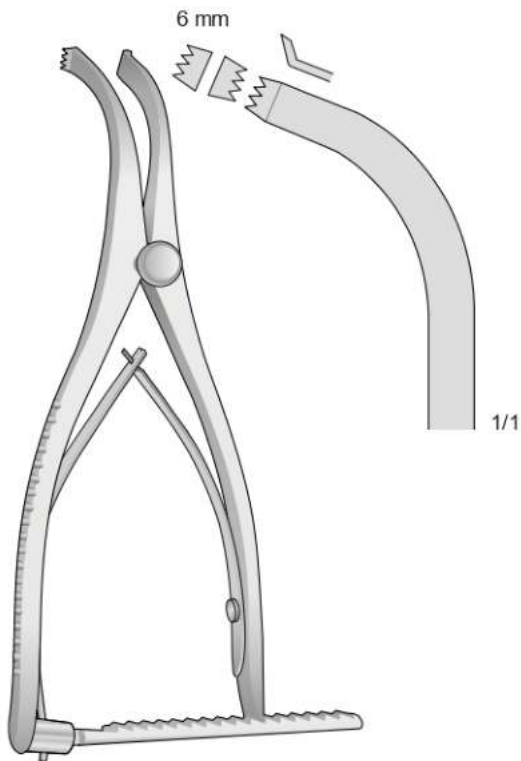
CLOWARD
ST-9411
150 mm



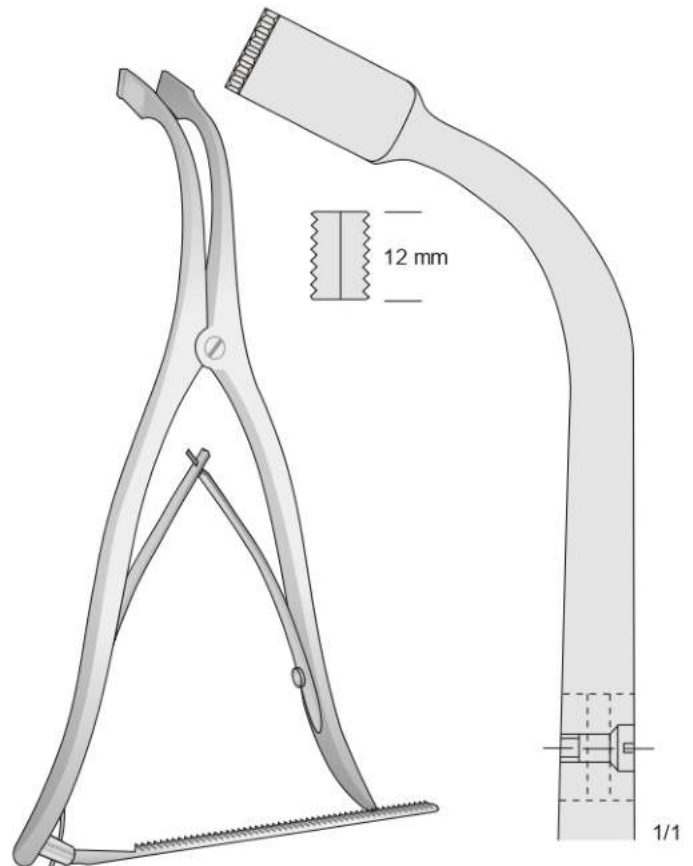
CLOWARD
ST-9412
160 mm



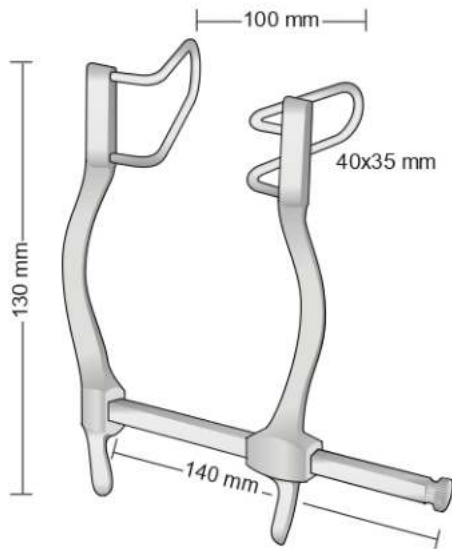
CLOWARD
ST-9413
160 mm



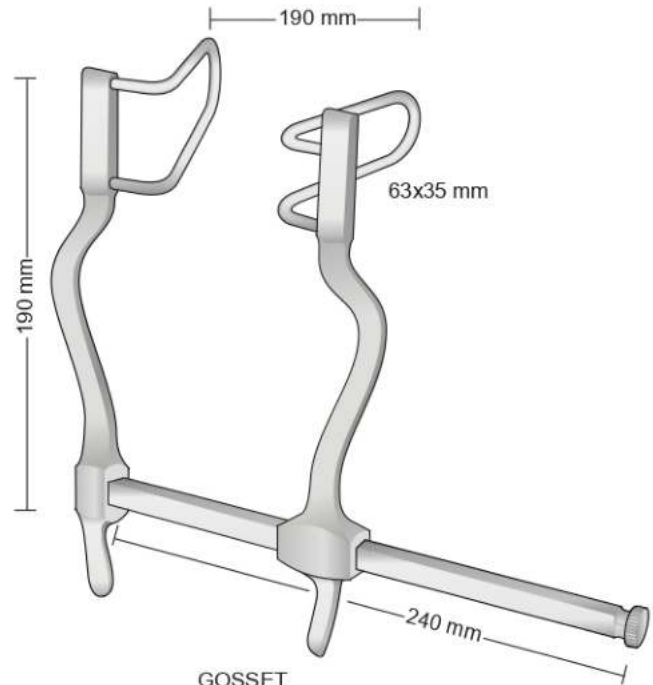
INGE
ST-9414
160 mm



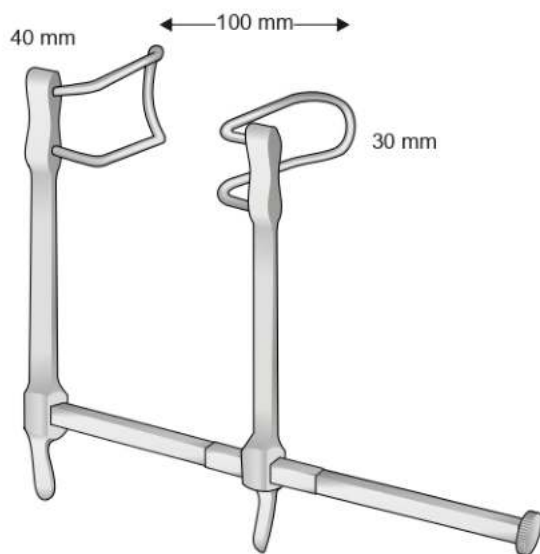
INGE
ST-9415
275 mm



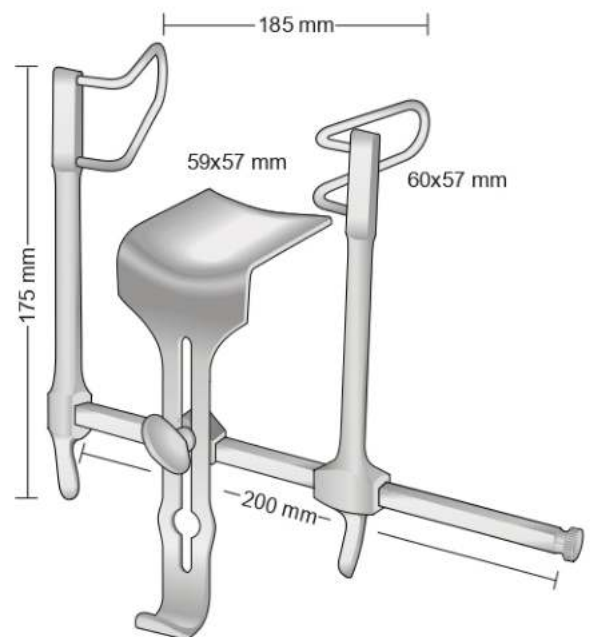
GOSSET
ST-9416



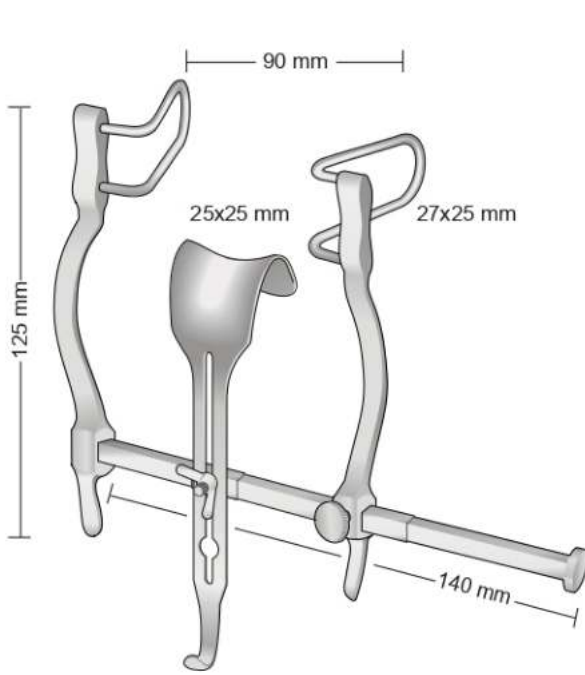
GOSSET
ST-9417



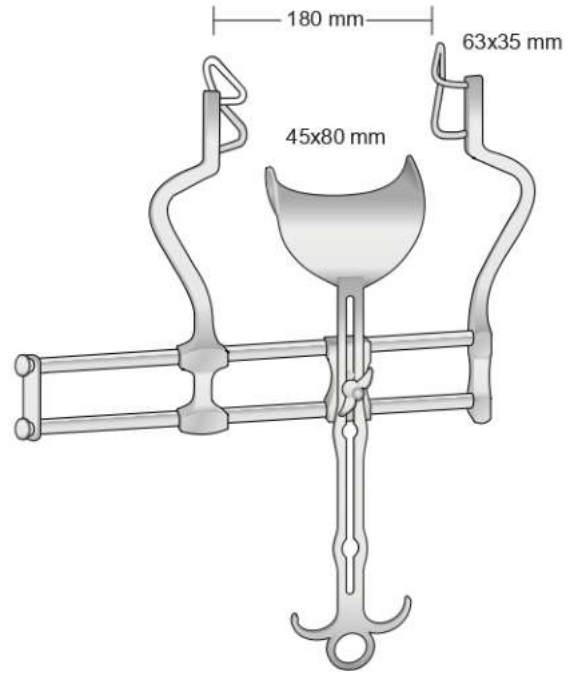
GOSSET
ST-9418



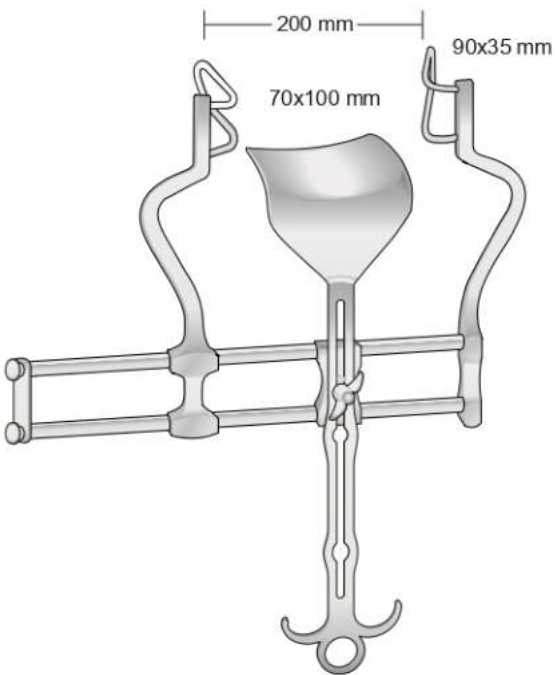
GOSSET
ST-9419



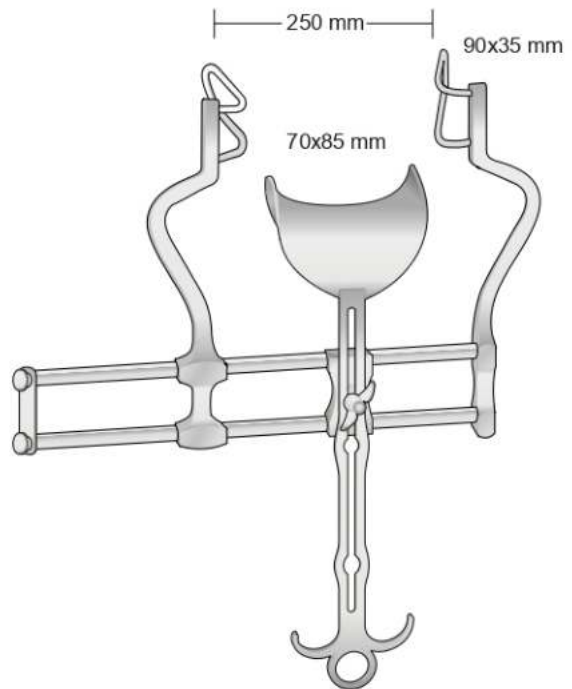
BALFOUR-BABY
ST-9420



BALFOUR
ST-9421



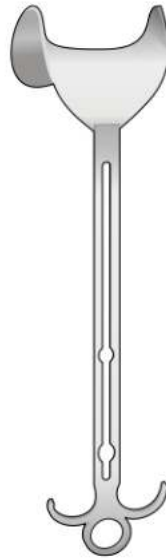
BALFOUR
ST-9422



BALFOUR
ST-9423



Valva centrale - Center blade
Mittelblatt - Valve centrale - Valva central



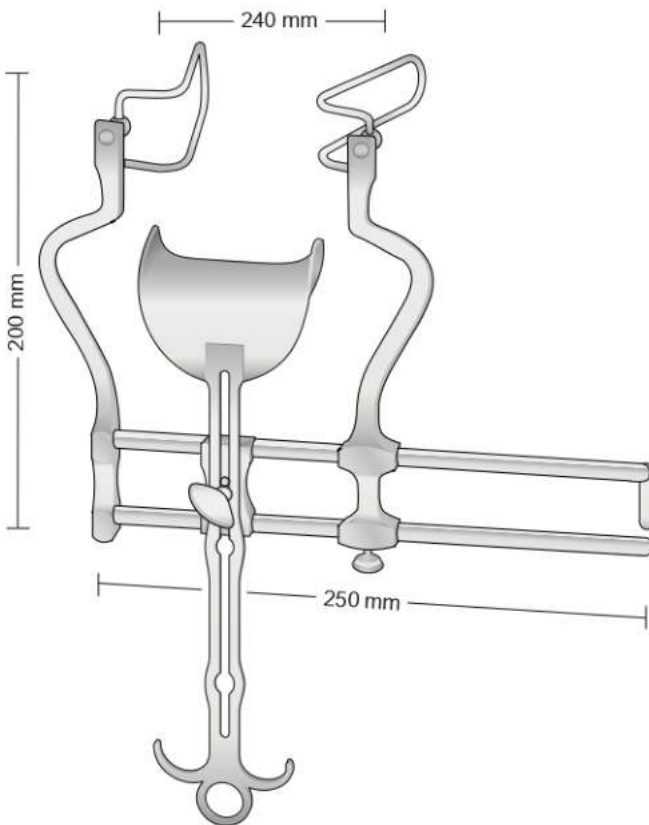
BALFOUR
ST-9425
45 x 80 mm

Valve laterali - paio
Lateral blades - pair
Seitliche Blätter - Paar
Valves latérales - paires
Valvas laterales - pares



ST-9426-1 - 50 mm
ST-9426-2 - 60 mm
ST-9426-3 - 75 mm
ST-9426-4 - 90 mm

ST-9424-1
Completo con:
Complete with:
Komplett mit:
Complet avec:
Completo con:



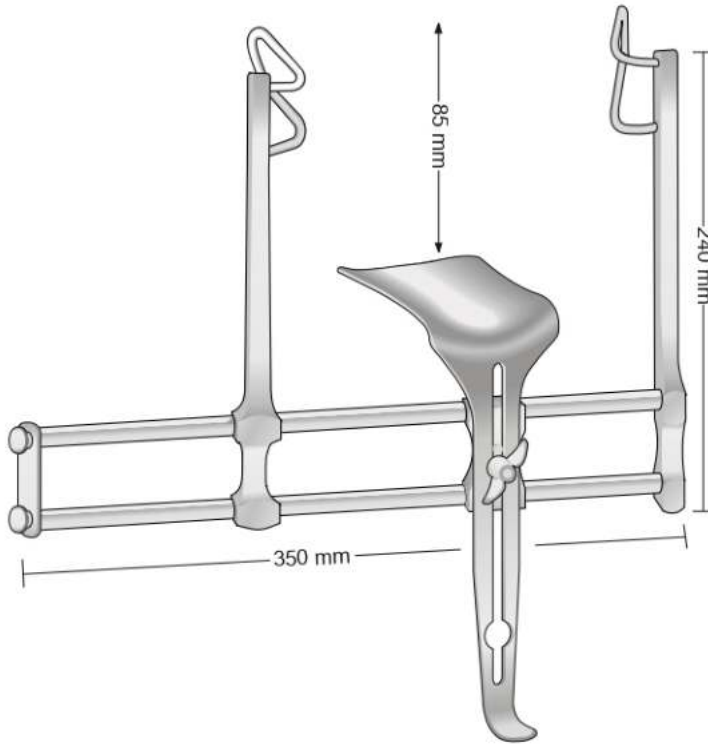
BALFOUR
ST-9424

ST-9424-2
BALFOUR
Divaricatore solo
Retractor only
Sperrer allein
Ecarteur seul
Separador suelto

ST-9424-1
Valva centrale
Center blade
Mittelblatt
Valve centrale
Valva central
45 x 80 mm

ST-9424-3
Valva centrale
Center blade
Mittelblatt
Valve centrale
Valva central
60 x 80 mm

ST-9424-4
Valva centrale
Center blade
Mittelblatt
Valve centrale
Valva central
80 x 80 mm



BALFOUR MODIF.
ST-9427

45 X 85 mm



ST-9427-1
170 mm

75 X 65 mm

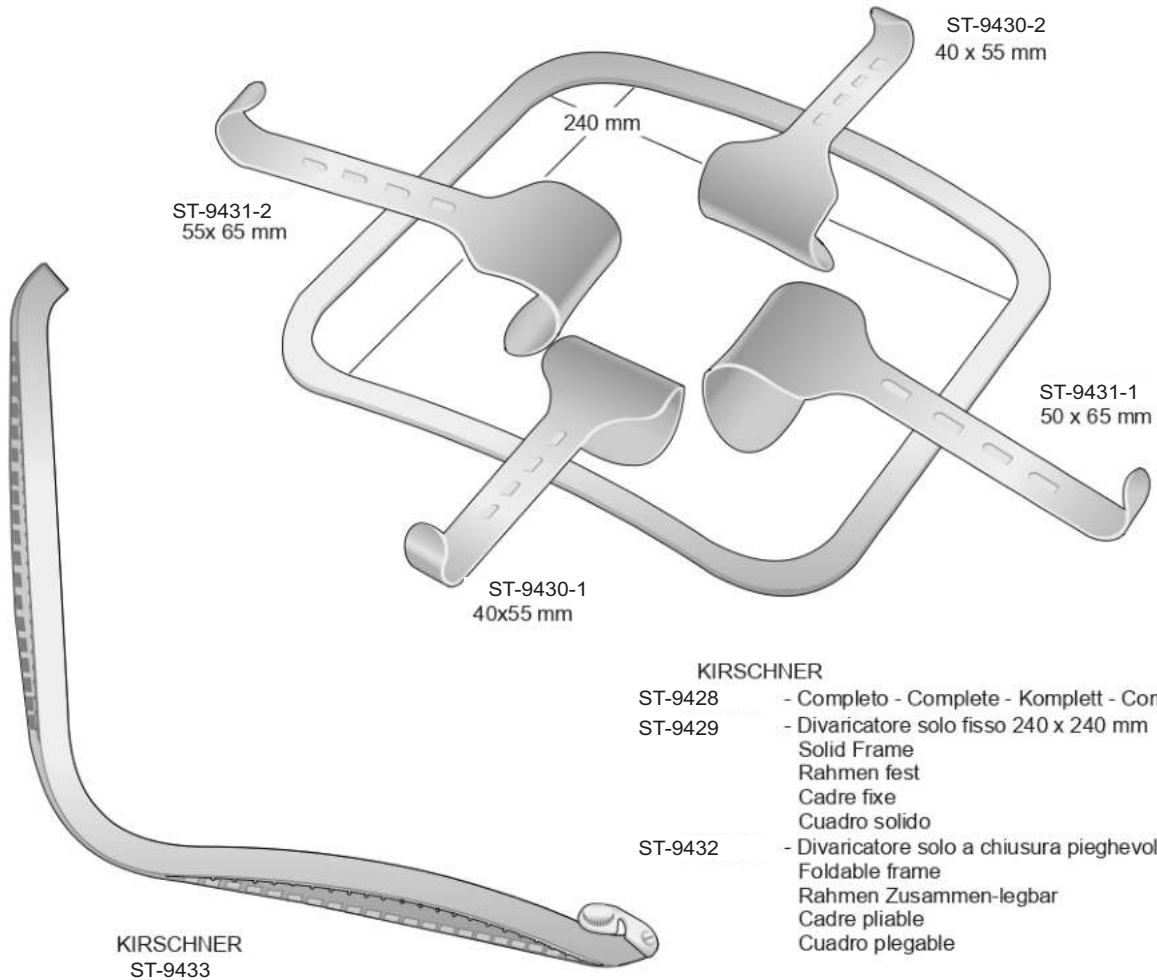


ST-9427-2
230 mm

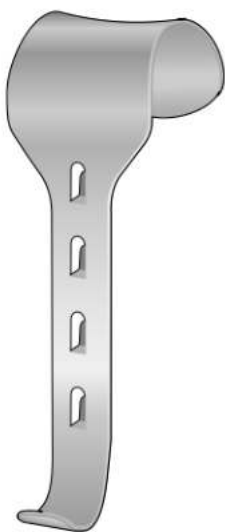
70 X 100 mm



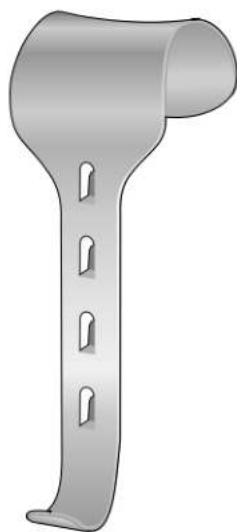
ST-9427-3
200 mm



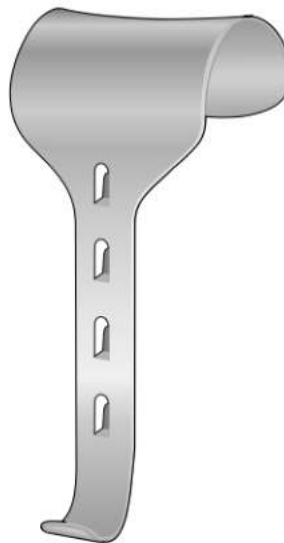
- KIRSCHNER**
- ST-9428 - Completo - Complete - Komplett - Complet - Completo
 - ST-9429 - Divaricatore solo fisso 240 x 240 mm
Solid Frame
Rahmen fest
Cadre fixe
Cuadro solido
 - ST-9432 - Divaricatore solo a chiusura pieghevole 240 x 240 mm
Foldable frame
Rahmen Zusammen-legbar
Cadre pliable
Cuadro plegable



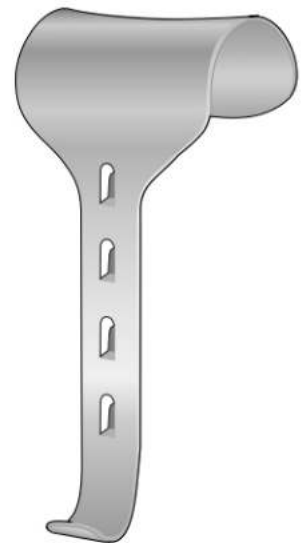
KIRSCHNER
ST-9434-1
40 x 55 mm



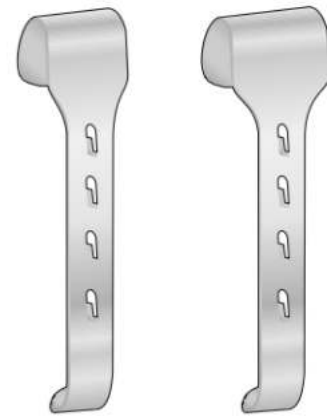
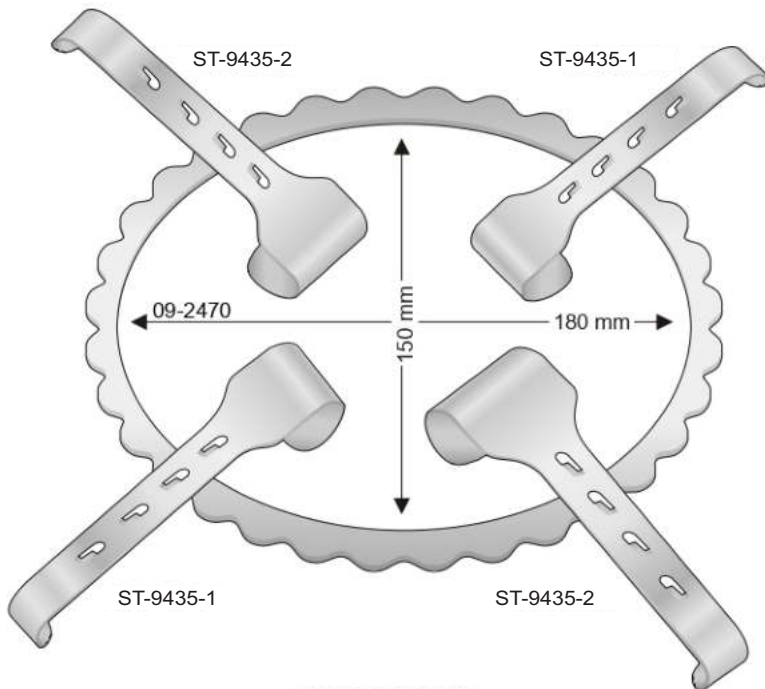
KIRSCHNER
ST-9434-2 - 65 x 80 mm
ST-9434-3 - 50 x 65 mm



KIRSCHNER
ST-9434-4 - 60 x 85 mm
ST-9434-5 - 78 x 65 mm
ST-9434-6 - 90 x 65 mm



KIRSCHNER
ST-9434-7 - 80 x 80 mm
ST-9434-8 - 80 x 90 mm
ST-9434-9 - 90 x 90 mm



ST-9435-3
20 x 30 mm

ST-9435-4
20 x 40 mm

DENIS-BROWNE
ST-9436

Set completo per bambini
Set complete for children
Komplettsset für kinder
Set complete pour enfants
Set completo para niños

- ST-9435 - 1 Cornice 180 x 150 mm
- ST-9435-3 - 2 Valve 20 x 30 mm
- ST-9435-4 - 2 Valve 20 x 40 mm

DENIS-BROWNE
ST-9437

Set completo per adulti
Set complete for adults
Komplettsset für Erwachsene
Set complete pour adultes
Set completo para adultos

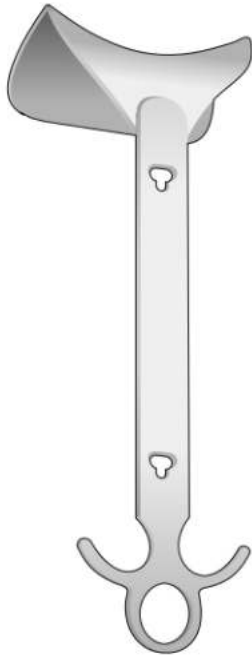
- ST-9438 - 1 Cornice 255 x 180 mm
- ST-9438-1 - 2 Valve 40 x 30 mm
- ST-9438-2 - 2 Valve 40 x 40 mm

ST-9435
180 x 150 mm
Cornice sola
Frame only
Rahmen allein
Ecarteur seul
Separador suelto

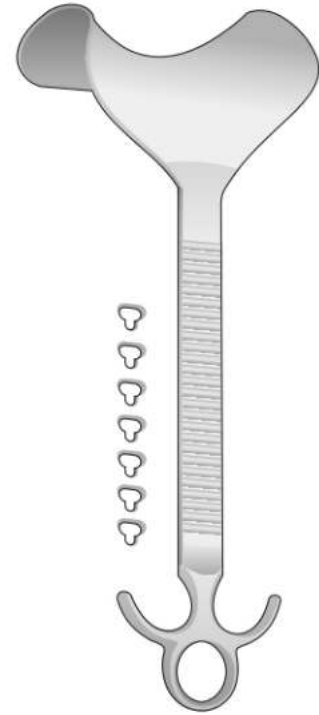
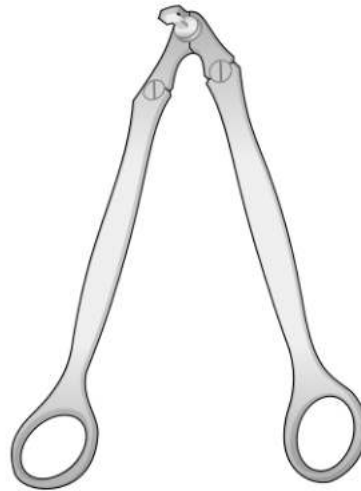
Per bambini - For children
Für kinder - Pour enfants
Para niños

ST-9438
255 x 180 mm
Cornice sola
Frame only
Rahmen allein
Ecarteur seul
Separador suelto

Per adulti - For adults
Für erwachsene - Pour adultes
Para adultos



Dispositivo di fissaggio
Fixation device
Fixiervorrichtung
Dispositif de fixation articulé
Dispositivo de fijación



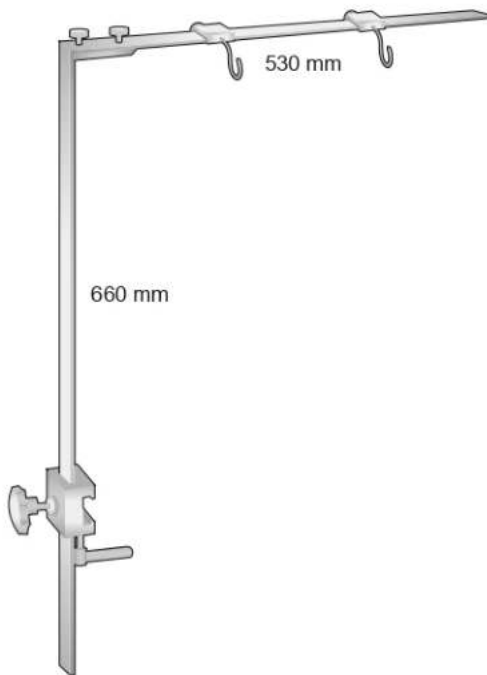
ROCHARD

- ST-9439-1 - 60 x 95 mm
- ST-9439-2 - 60 x 105 mm
- ST-9439-3 - 60 x 120 mm
- ST-9439-4 - 60 x 135 mm
- ST-9439-5 - 60 x 155 mm
- 270 mm

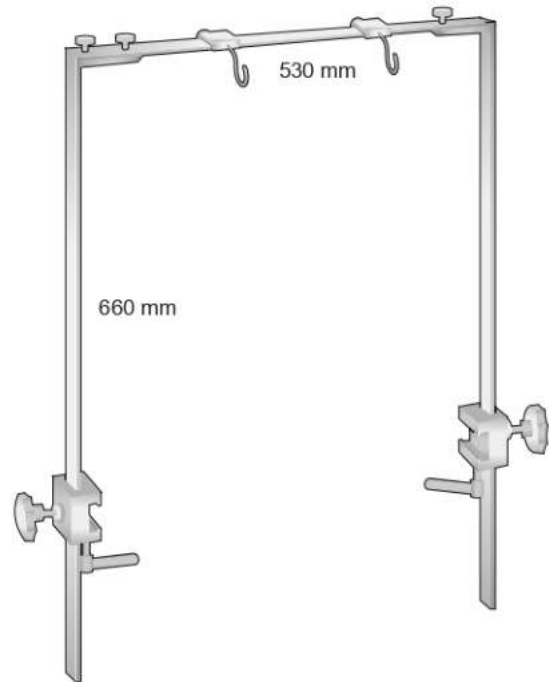
ROCHARD
ST-9440
190 mm

DOYEN

- ST-9441-1 - 50 x 85 mm
- ST-9441-2 - 48 x 90 mm
- ST-9441-3 - 48 x 105 mm
- ST-9441-4 - 48 x 120 mm
- ST-9441-5 - 48 x 135 mm
- 280 mm



ROCHARD
ST-9442-1



ROCHARD
ST-9442-2



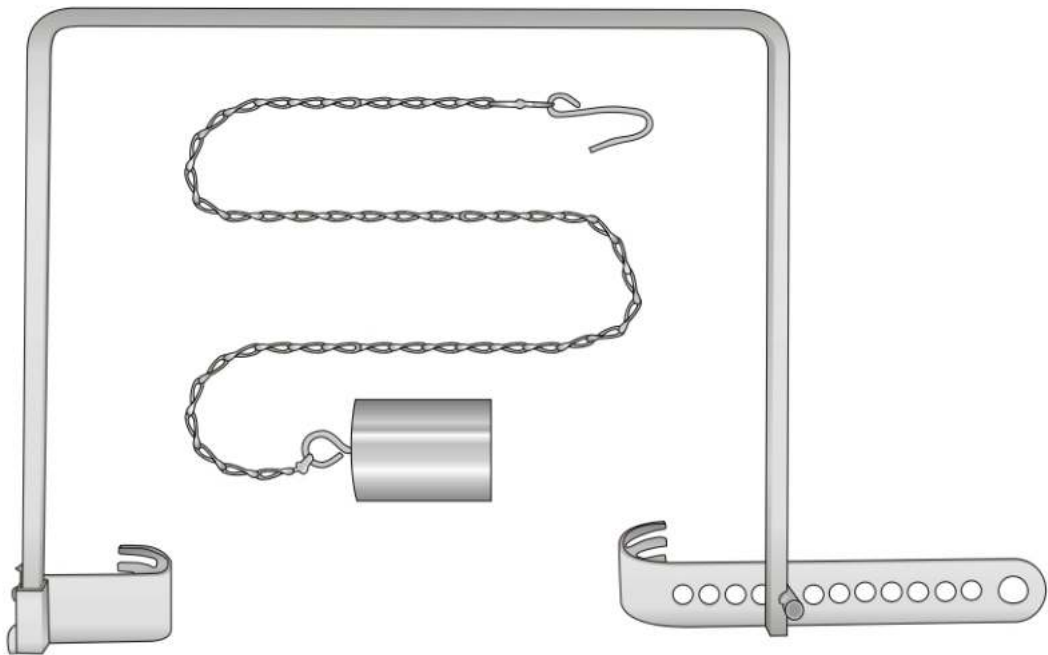
ST-9443-1
Valva regolabile
Large blade

ST-9443-2
Valva piccola
Small blade

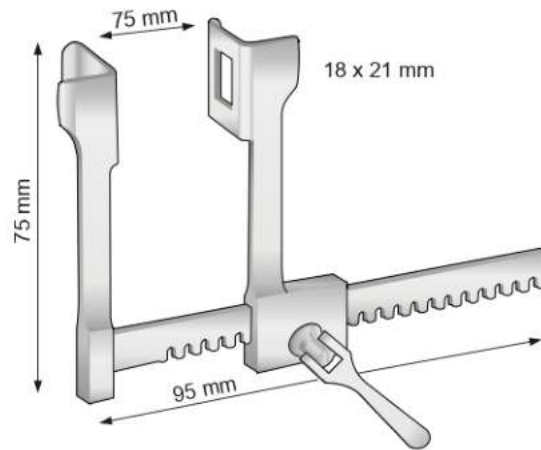
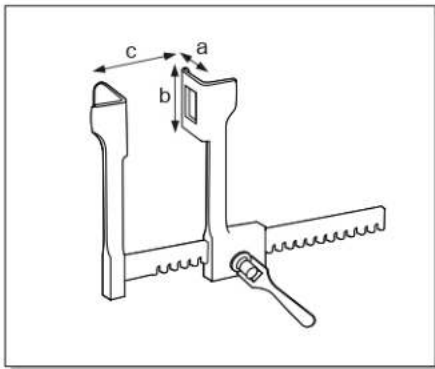
ST-9443-3
Contrappeso + catenella
Weight with chain

Divaricatore per anca
Retractor with chain
Wundhaken mit Kette

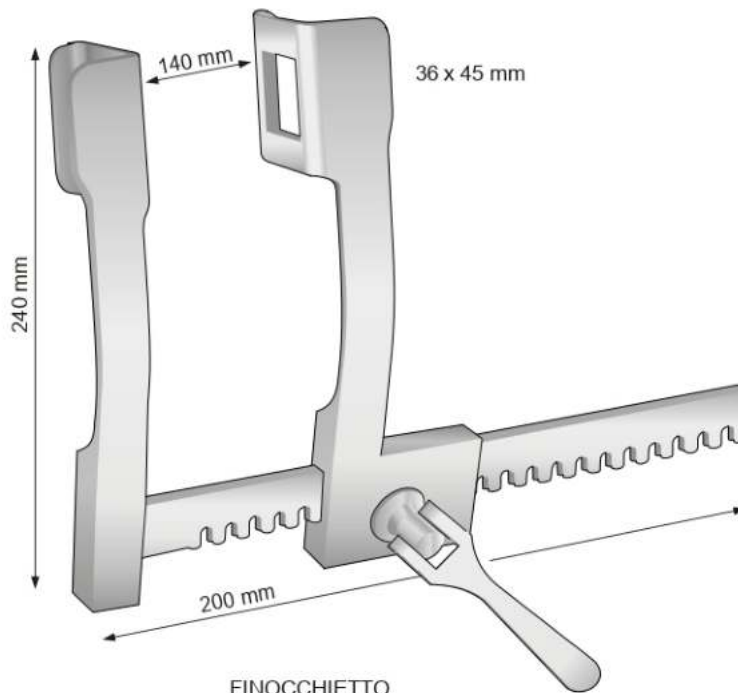
Completo - Complete - Komplet
Complete - Completos



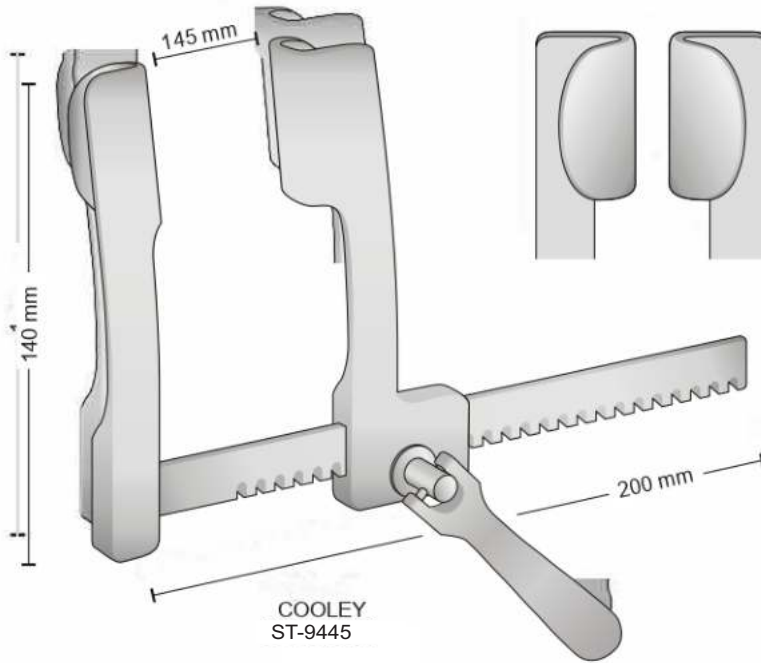
CHARNELY
ST-9443



BABY FINOCCHIETTO
a b c
ST-9444 18 x 20 mm 75 mm

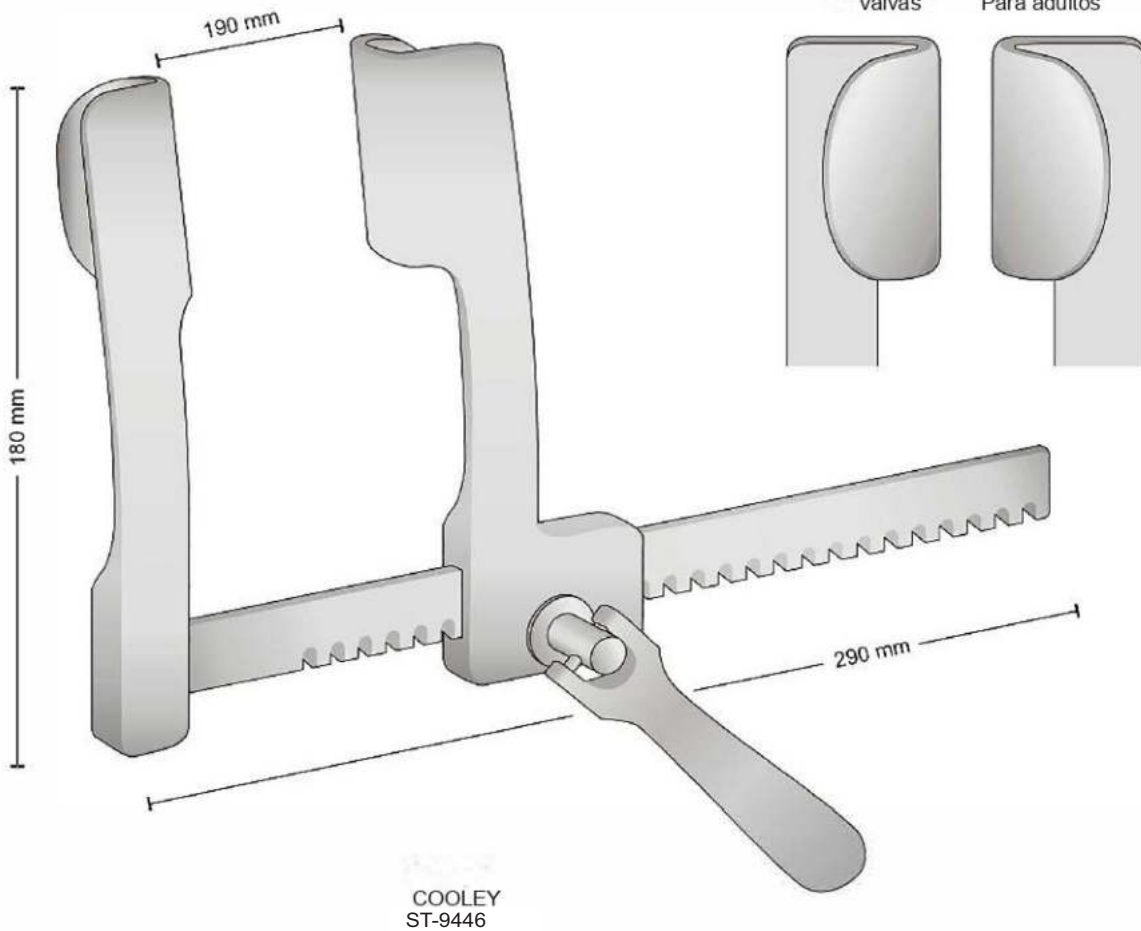


FINOCCHIETTO
a b c
ST-9444-1 40 x 40 mm 165 mm
ST-9444-2 45 x 65 mm 200 mm
ST-9444-3 70 x 65 mm 250 mm



Valve
Blades
Blätter
Valves
Valvas
21 x 45 mm

Per bambini
For children
Für kinder
Pour enfants
Para niños

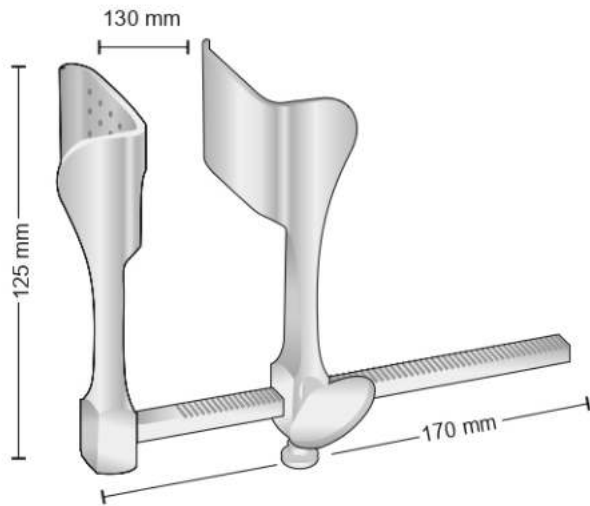


Valve
Blades
Blätter
Valves
Valvas

Per adulti
For adults
Für Erwachsene
Pour adultes
Para adultos

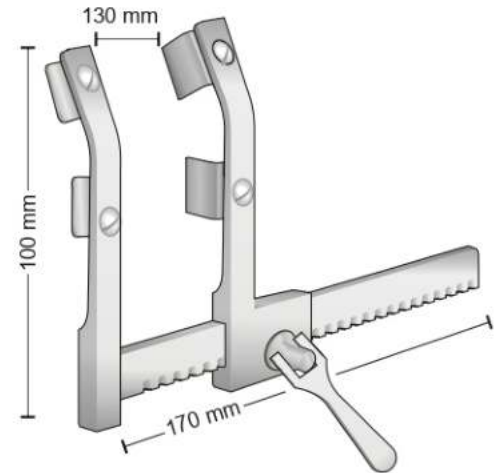


Valve - Blade - Blätter
Valve - Valvas
50 x 43 mm



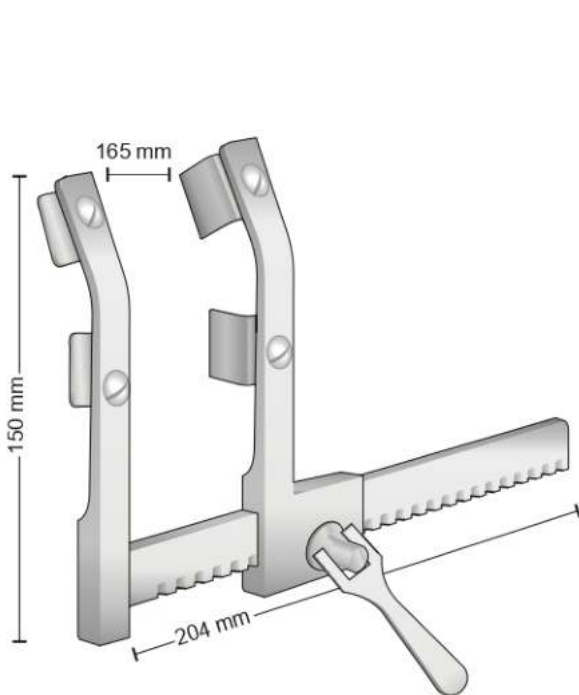
TUFFIER
ST-9447

Divaricatori per sternotomia
Sternotomy spreaders
Sternotomie-Sperrer
Ecarteurs à sternotomie
Separador para sternotomia

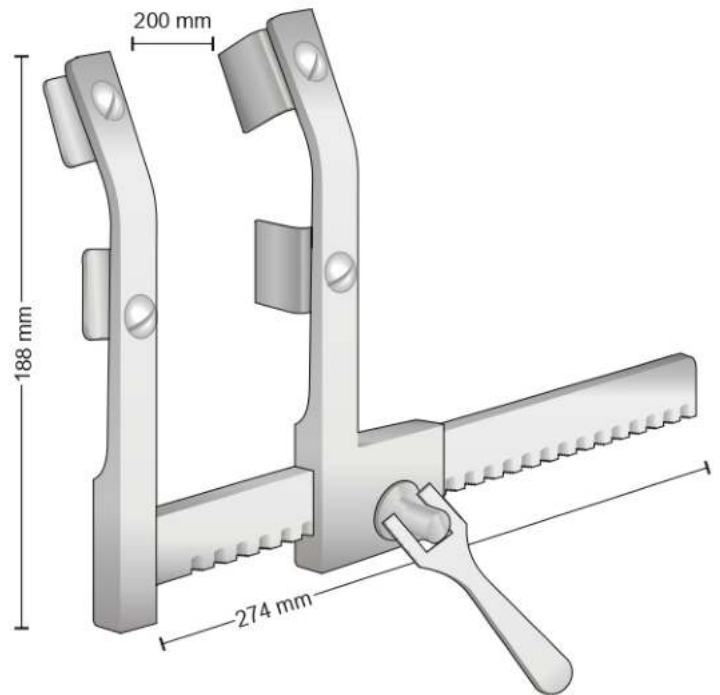


BABY-MORSE
ST-9448

Divaricatori per sternotomia - Sternotomy spreaders - Sternotomie-Sperrer
Ecarteurs à sternotomie - Separador para sternotomia



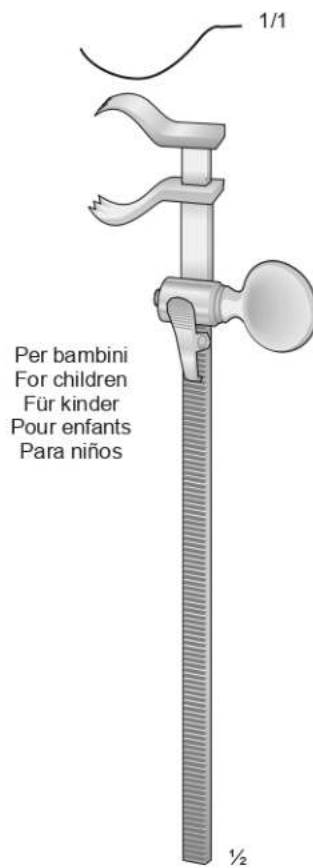
MORSE
ST-9449



MORSE
ST-9450

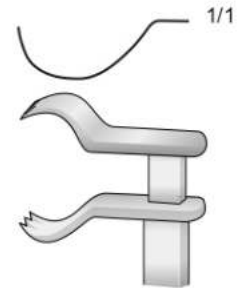


BAILEY
ST-9451
160 mm



Per bambini
For children
Für kinder
Pour enfants
Para niños

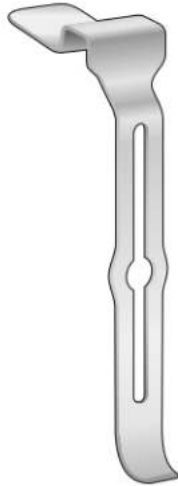
BAILEY
ST-9452
200 mm



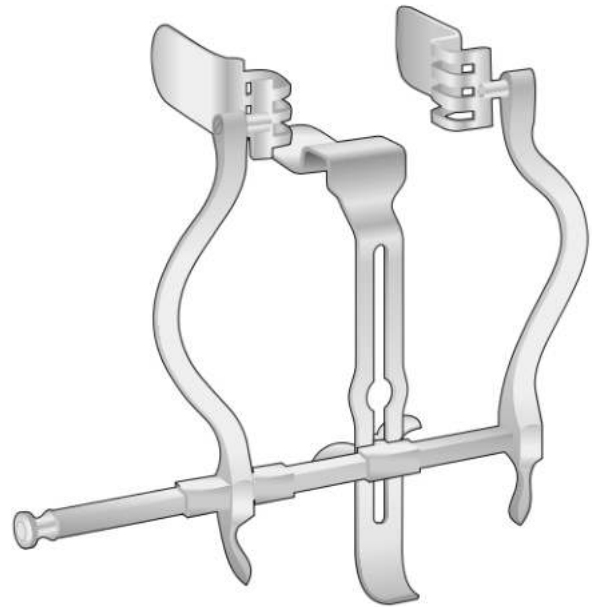
ST-9453
Per adulti
For adults
Für Erwachsene
Pour adultes
Para adultos



Valva centrale
Center blade
Mittelblatt
Valve centrale
Valva central

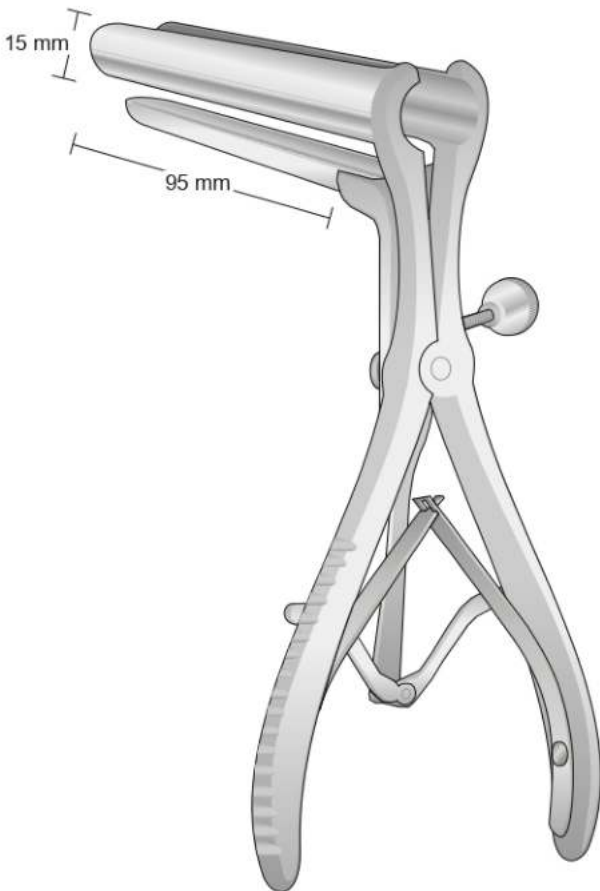


ST-9454



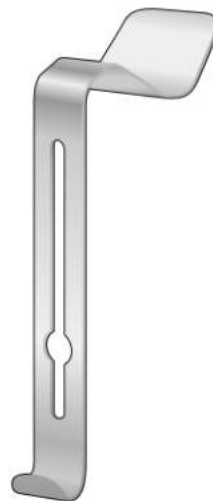
JUDD-MASSON
ST-9455

Speculum rettale
Rectal specula
Mastdarm rektum spekulum
Spéculum pour rectum
Espéculus rectales



MATHIEU
ST-9456
215 mm

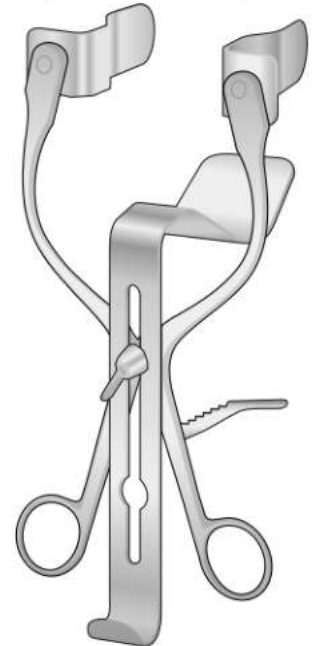
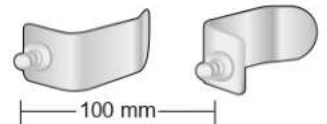
09-2650-04
Valva laterale
Lateral blade
Seitliche Blätter
Valves latérales
Valva laterales
80 x 25 mm



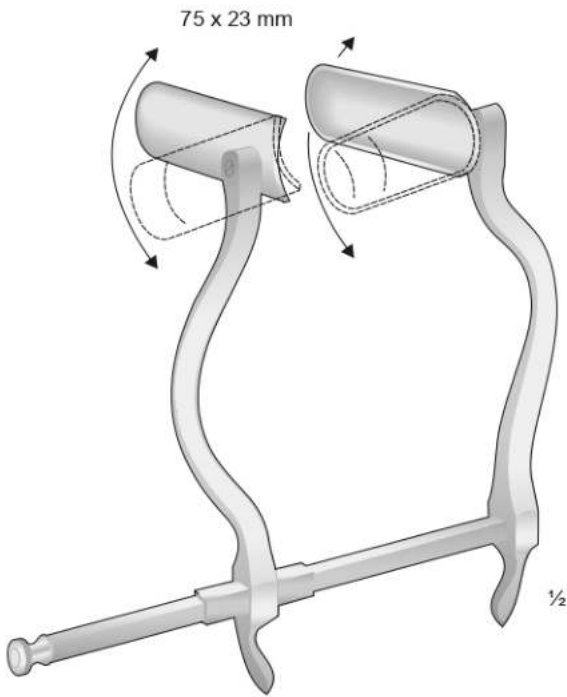
ST-9457

Valva centrale - Center blade - Mittelblatt
Valve centrale - Valva central

09-2650-03
Divaricatore solo - Retractor only
Sperrer allein - Ecarteur seul
Separador suelto



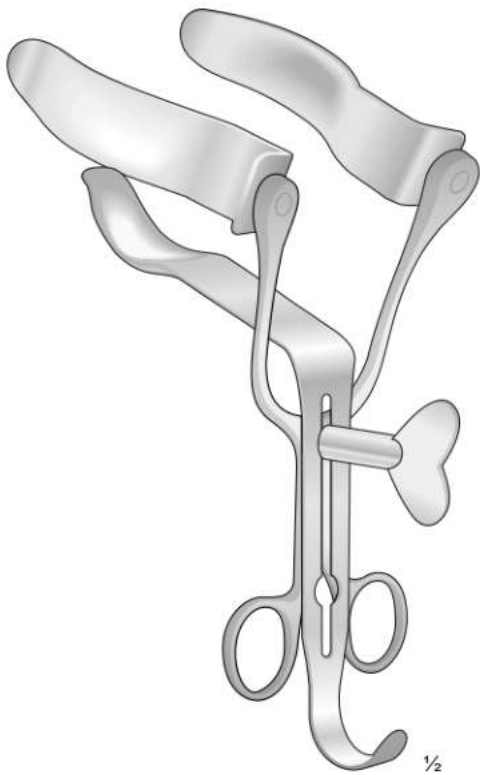
MILLIN
ST-9458
Completo - Complete - Komplet
Complet - Completo



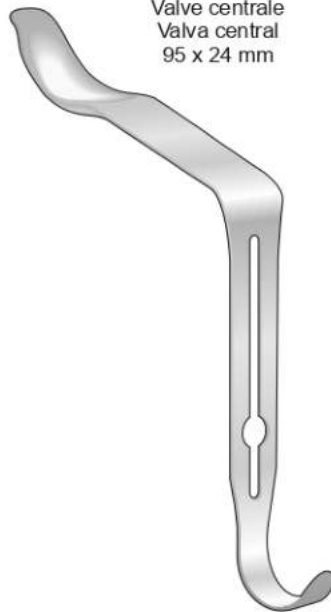
SMITH-BUIE
ST-9459
150 mm



BARR
ST-9460
170 mm

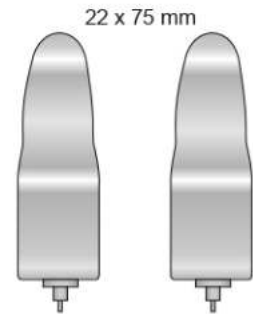


ALAN PARKS
ST-9461
135 mm



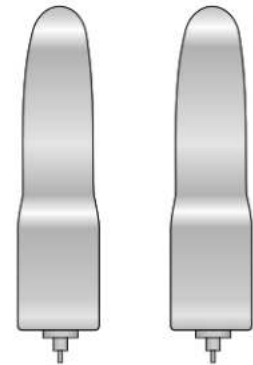
Valva centrale
Center blade
Mittelblatt
Valve centrale
Valva central
95 x 24 mm

ST-9462



09-2890-02

22 x 95 mm

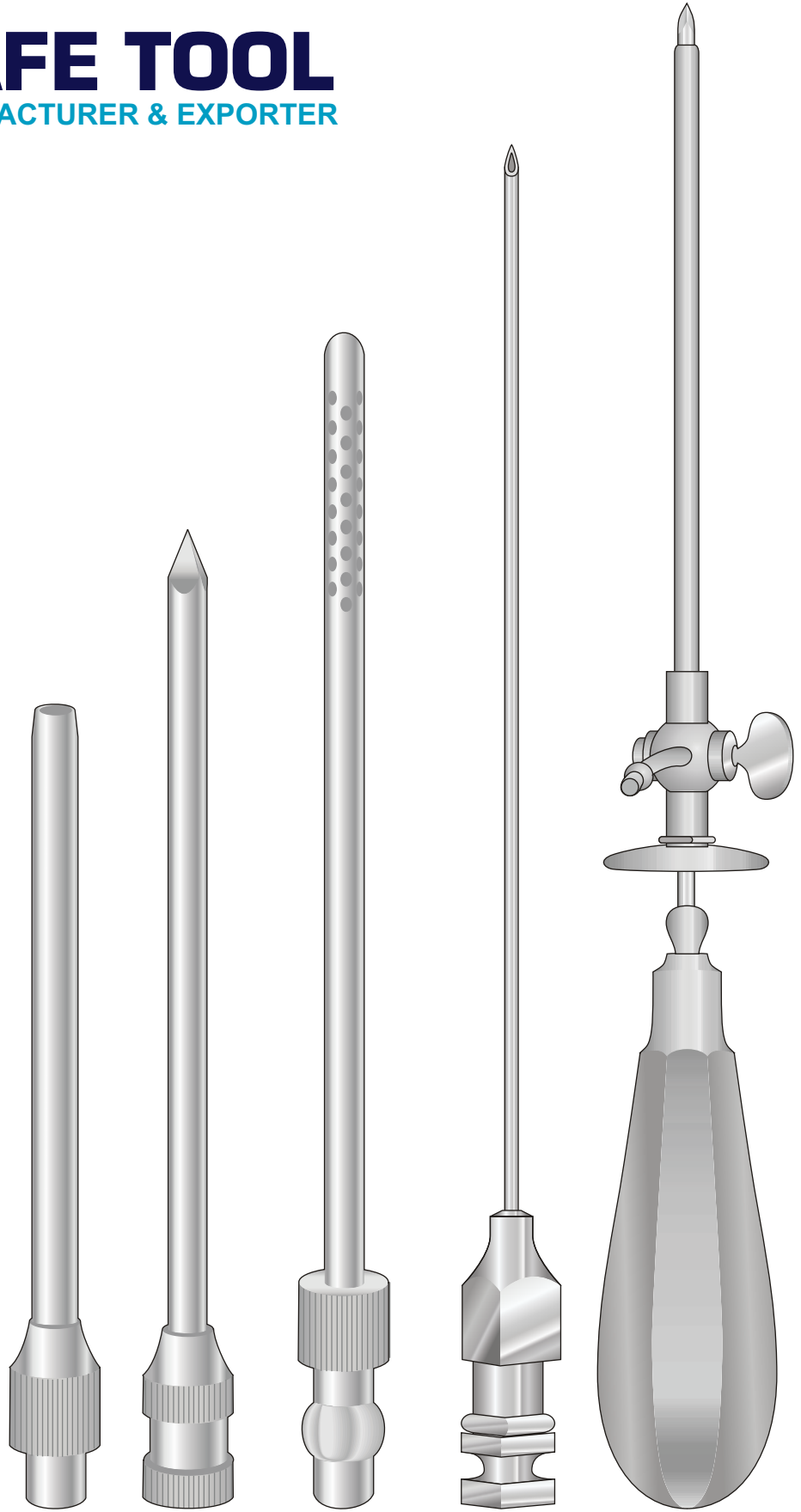


ST-9463



SAFE TOOL
MANUFACTURER & EXPORTER

Trocar, Biopsy Needles



www.safetool.com.pk

*Surgical
Instruments*



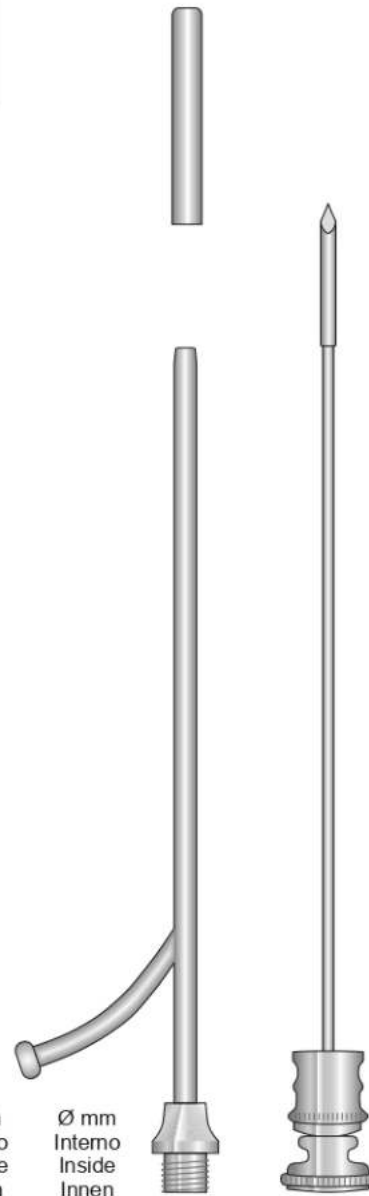
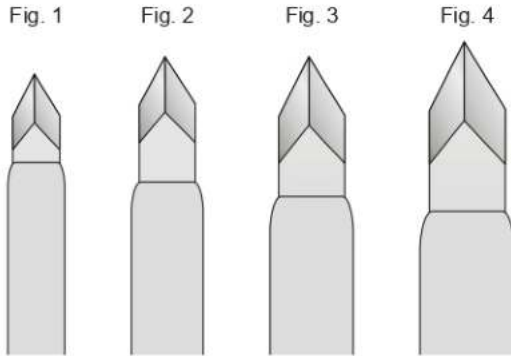
Ø mm
Esterno
Outside
Außen
Extérieur
Exterior

Ø mm
Interno
Inside
Innen
Intérieur
Interior

	ST-11501 STANDARD	ST-11502 STANDARD	ST-11503 STANDARD
3,0	ST-11501-1	ST-11502-1	ST-11503-1
3,5	ST-11501-2	ST-11502-2	ST-11503-2
4,0	ST-11501-3	ST-11502-3	ST-11503-3
4,5	ST-11501-4	ST-11502-4	ST-11503-4
5,0	ST-11501-5	ST-11502-5	ST-11503-5
5,5	ST-11501-6	ST-11502-6	ST-11503-6
6,0	ST-11501-7	ST-11502-7	ST-11503-7
	110 mm	120 mm	120 mm



Per vescica biliare - For gall bladder - Für die gallenblase
Pour la vésicule biliaire - Para vesícula biliar



Ø mm Esterno Outside Außen Extérieur Exterior	Ø mm Interno Inside Innen Intérieur Interior		
7,5	6,0	Fig. 1	NELSON 10-130-01
9,5	8,0	Fig. 2	10-130-02
11,0	9,5	Fig. 3	10-130-03
12,5	11,0	Fig. 4	10-130-04
210 mm			

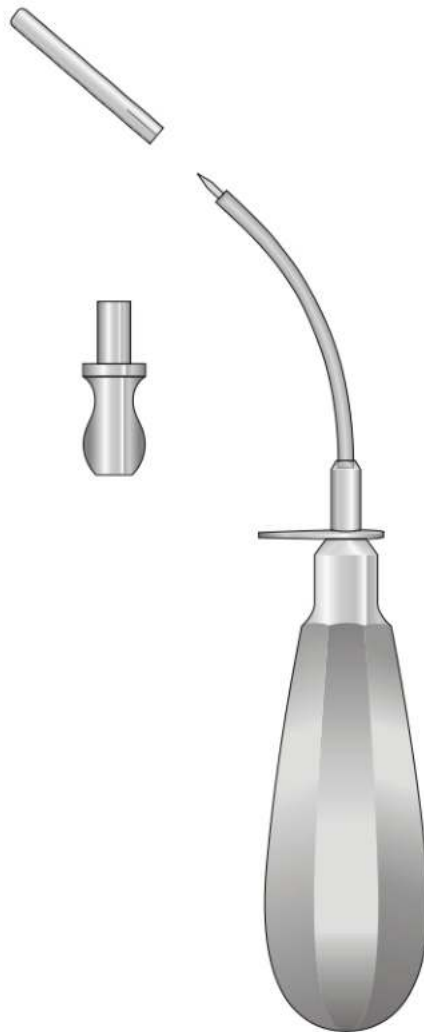
Ø mm Esterno Outside Außen Extérieur Exterior	Ø mm Interno Inside Innen Intérieur Interior	
4,0	3,0	OCHSNER ST-11505-1
4,6	3,6	ST-11505-2
5,3	4,3	ST-11505-3
6,0	5,0	ST-11505-4
210 mm		



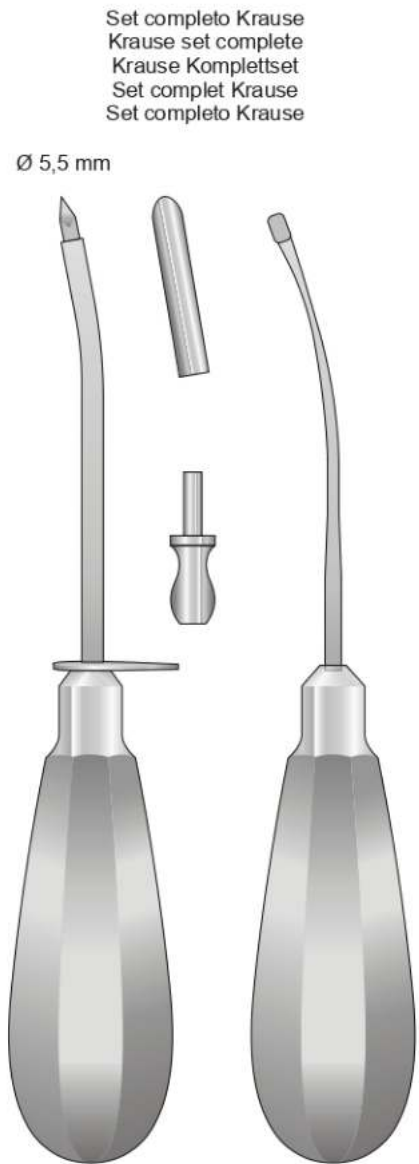
Trequarti per seno mascellare
Antrum puncture trocars
Kieferhöhlentrokare
Trocarts pour sinus maxillaire
Trócares para punción del seno maxilar



LICHTWITZ
ST-11506
190 mm



PIERCE
ST-11506-1 Ø 3 mm
ST-11506-2 Ø 4 mm
ST-11506-3 Ø 5 mm
160 mm



KRAUSE
ST-11507
160 mm

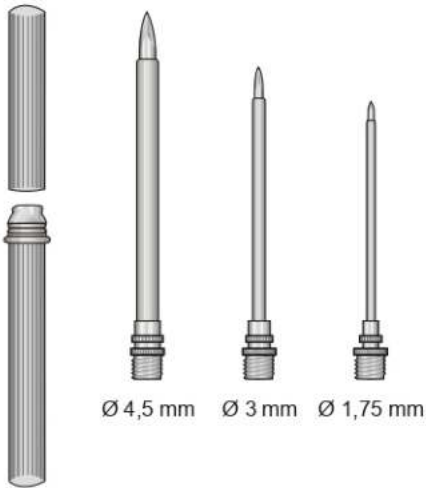
Set completo Krause
Krause set complete
Krause Kompletset
Set complet Krause
Set completo Krause

Ø 1,8 mm

Ø 5,5 mm

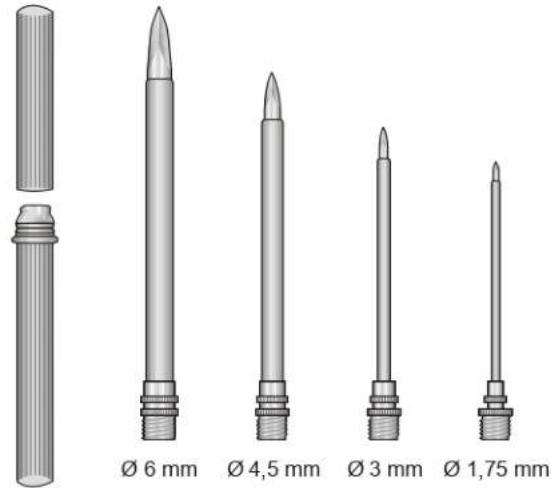


Universale completo con 3 punte
Set of 3 pieces
Satz zu 3 stück
Jeu de 3 pièces
Juego de 3 piezas



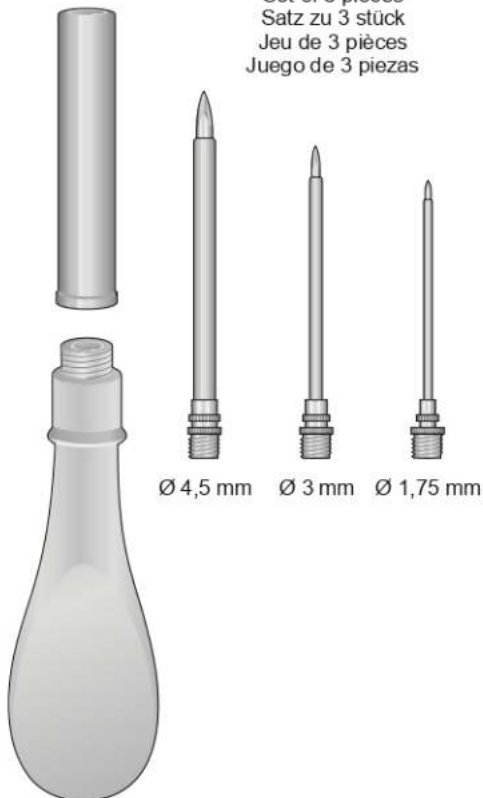
UNIVERSAL
ST-11509-1

Universale completo con 4 punte
Set of 4 pieces
Satz zu 4 stück
Jeu de 4 pièces
Juego de 4 piezas



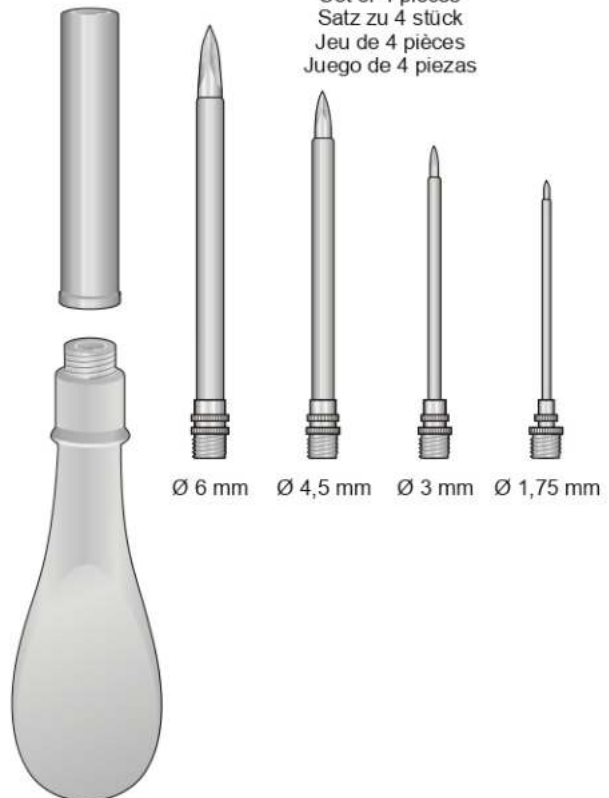
UNIVERSAL
ST-11509-2

Universale completo con 3 punte
Set of 3 pieces
Satz zu 3 stück
Jeu de 3 pièces
Juego de 3 piezas

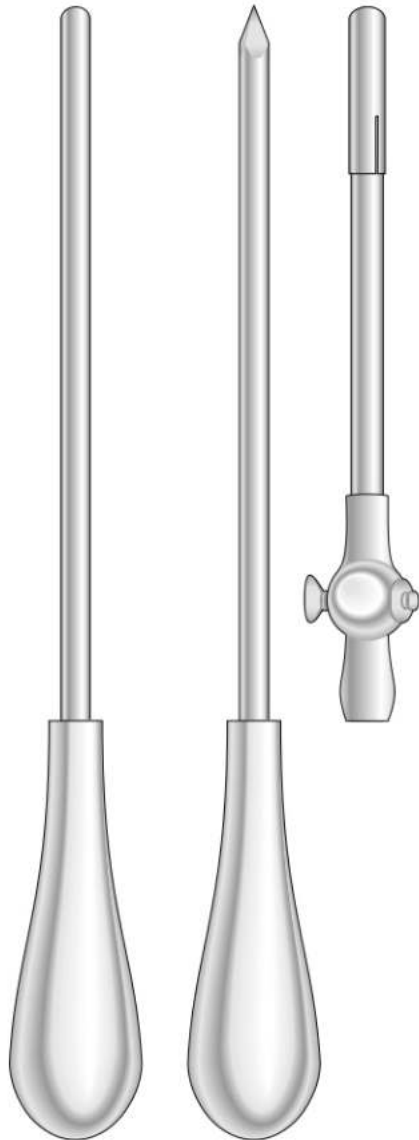


ST-11510-1
130 mm

Universale completo con 4 punte
Set of 4 pieces
Satz zu 4 stück
Jeu de 4 pièces
Juego de 4 piezas



ST-11510-2
130 mm



Ago per la puntura dello sterno
Sternal puncture needle
Sternal-punktionskänülen
Aiguilles pour la ponction sternale
Agujas para punción esternal



Ø mm	Ø mm
Esterno	Interno
Outside	Inside
Außen	Innen
Extérieur	Intérieur
Exterior	Interior

		BUELAU
8	6,5	ST-11511-1
10	8,5	ST-11511-2

240 mm

KLIMA-ROSEGGER
ST-11512
1,80 x 35 mm

DUKE
110 mm - 5,5 mm



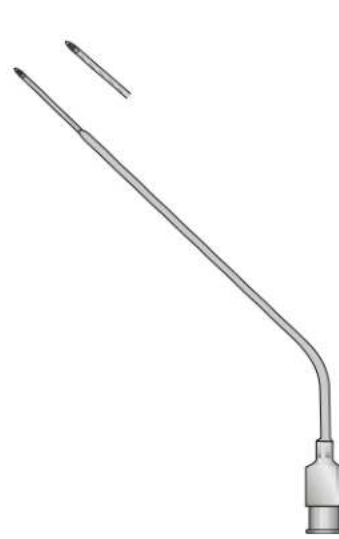
ST-11513-1
120 mm



ST-11513-2
110 mm



ST-11513-3
110 mm



ST-11513-4
110 mm



ST-11513-5
110 mm



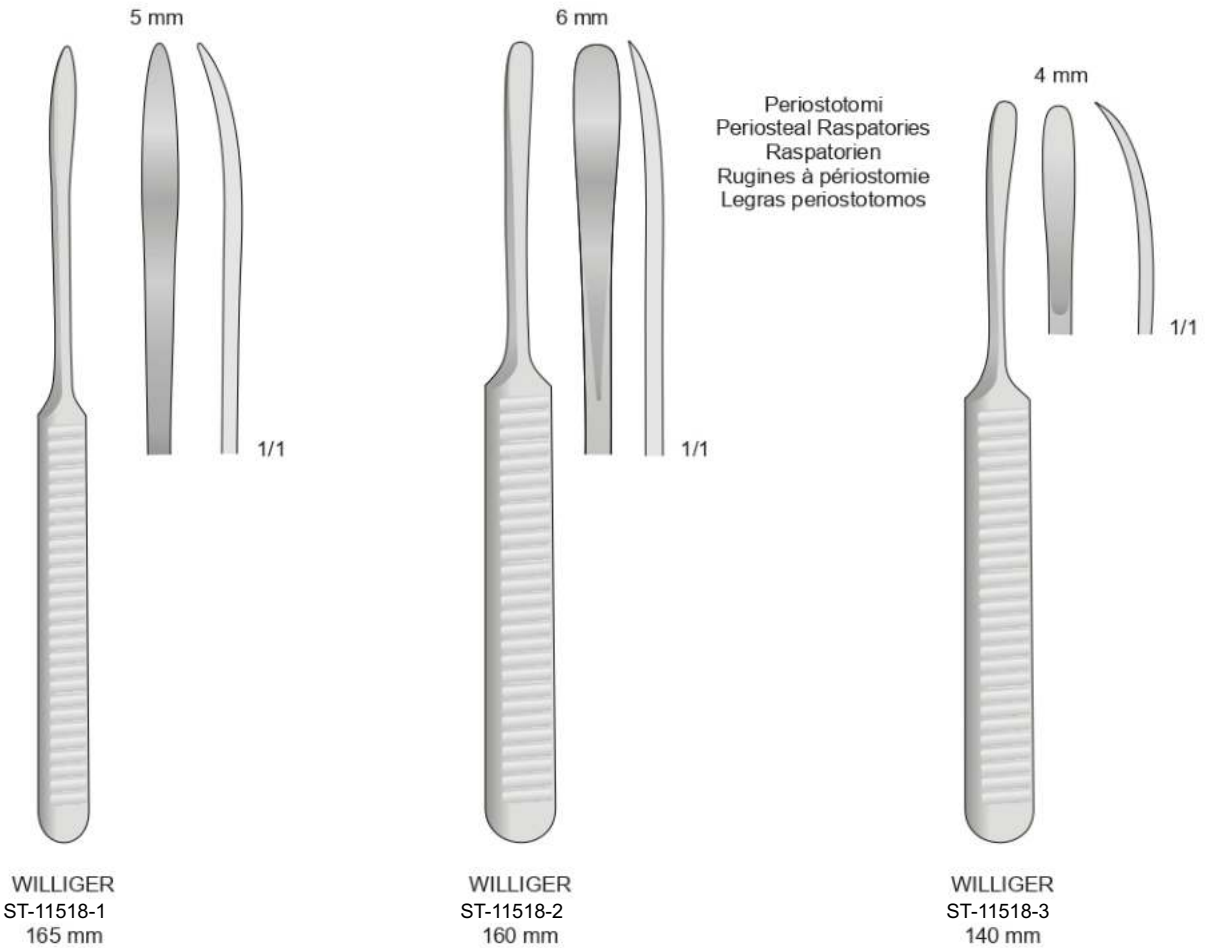
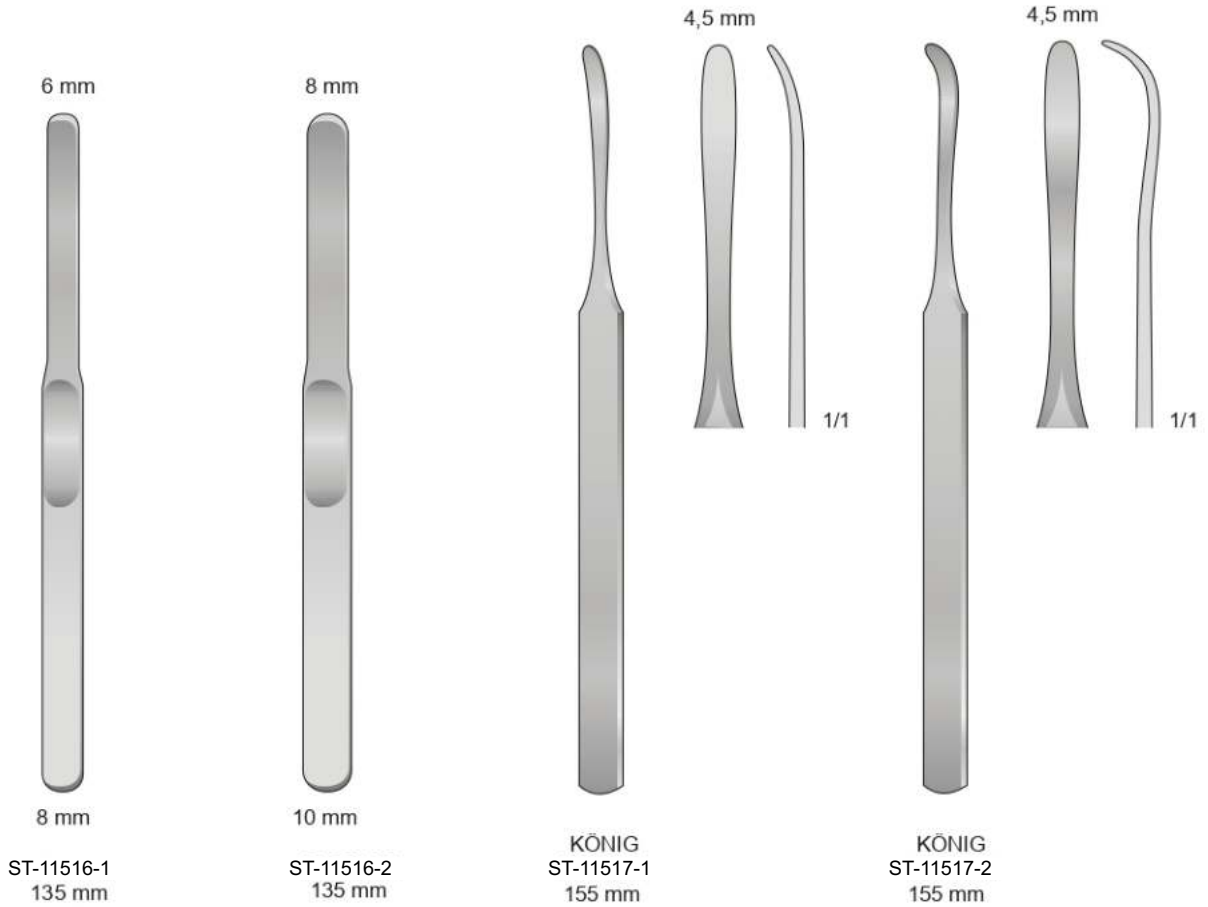
TUOHY

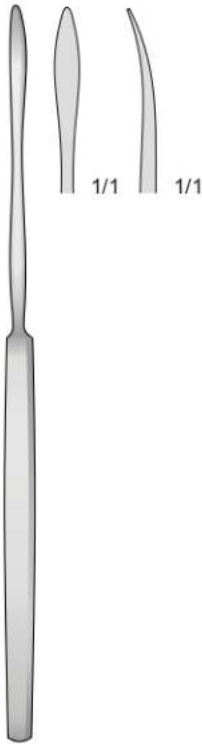
- ST-11514-1 - 1,30 x 80 mm
- ST-11514-2 - 1,50 x 80 mm
- ST-11514-3 - 1,65 x 80 mm



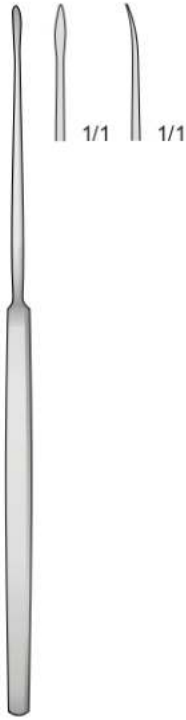
QUINCKE

- ST-11515-1 - 0,70 x 80 mm
- ST-11515-2 - 0,70 x 90 mm
- ST-11515-3 - 1,00 x 80 mm
- ST-11515-4 - 1,00 x 90 mm
- ST-11515-5 - 1,20 x 90 mm
- ST-11515-6 - 1,20 x 100 mm





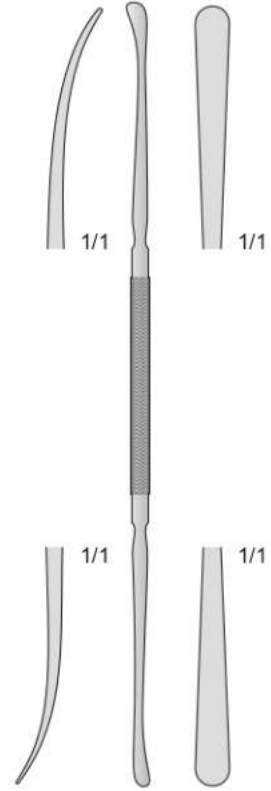
ST-11519-1
175 mm



ST-11519-2
160 mm



MILLIGAN
ST-11520
210 mm



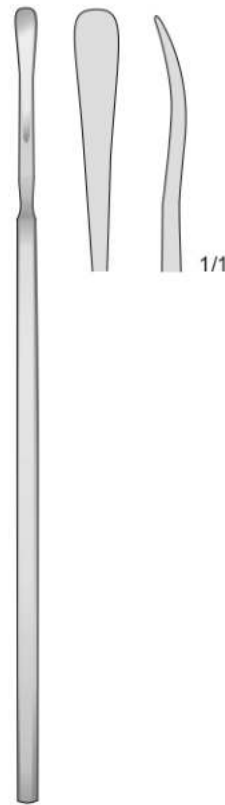
DAVIS
ST-11521
245 mm



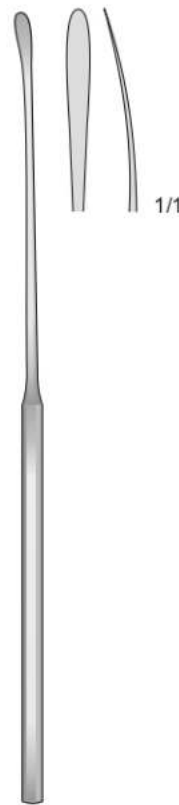
FAGER
ST-11522-1
200 mm



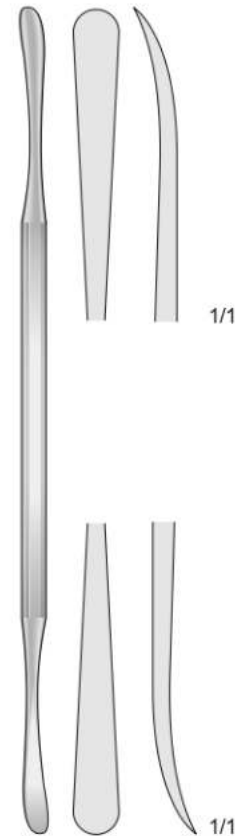
FAGER
ST-11522-2
200 mm



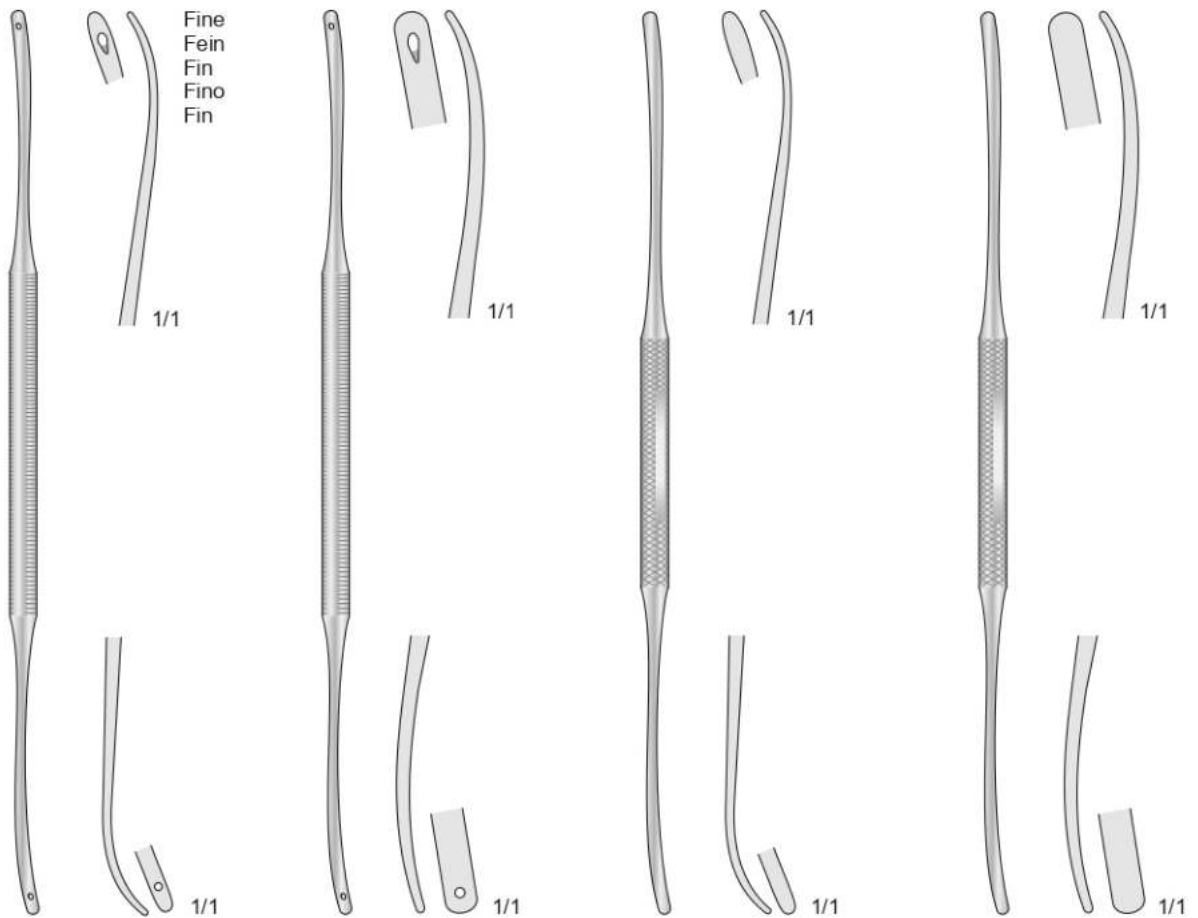
SACHS
ST-11523-1
210 mm



SACHS
ST-11523-2
210 mm



ST-11524
220 mm

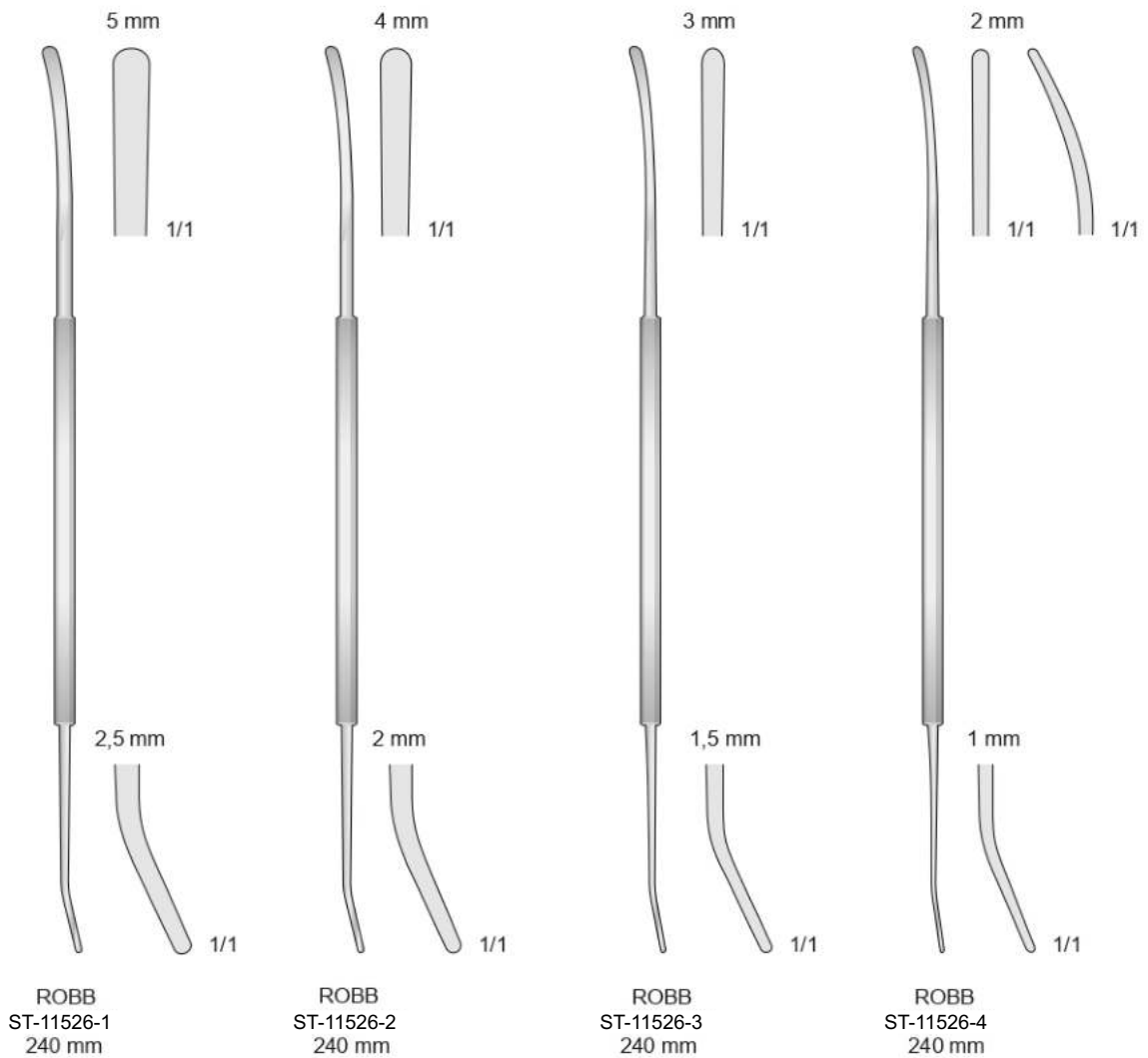


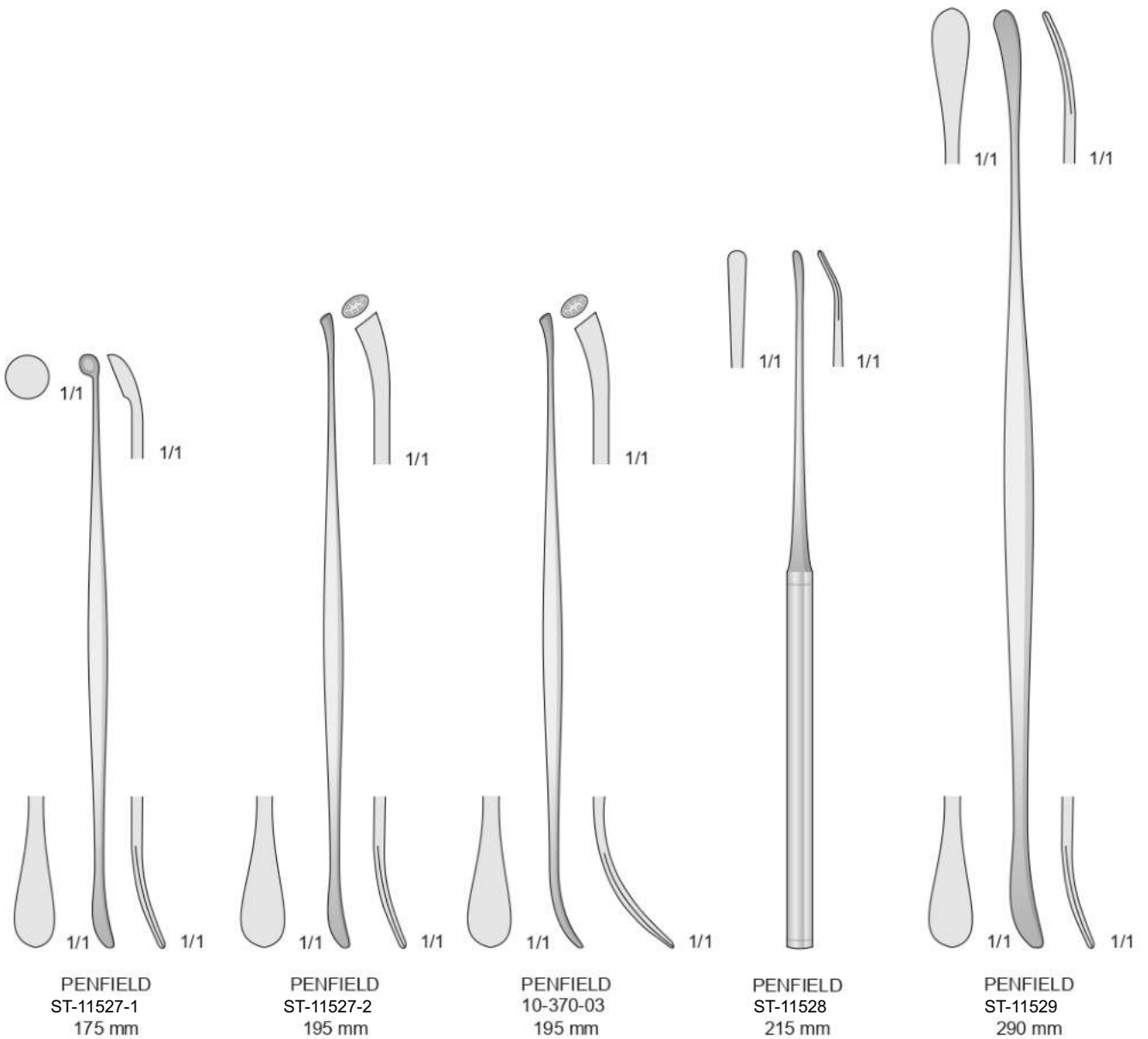
ST-11524-1 - 180 mm
ST-11524-2 - 240 mm

ST-11524-3 - 180 mm
ST-11524-4 - 240 mm

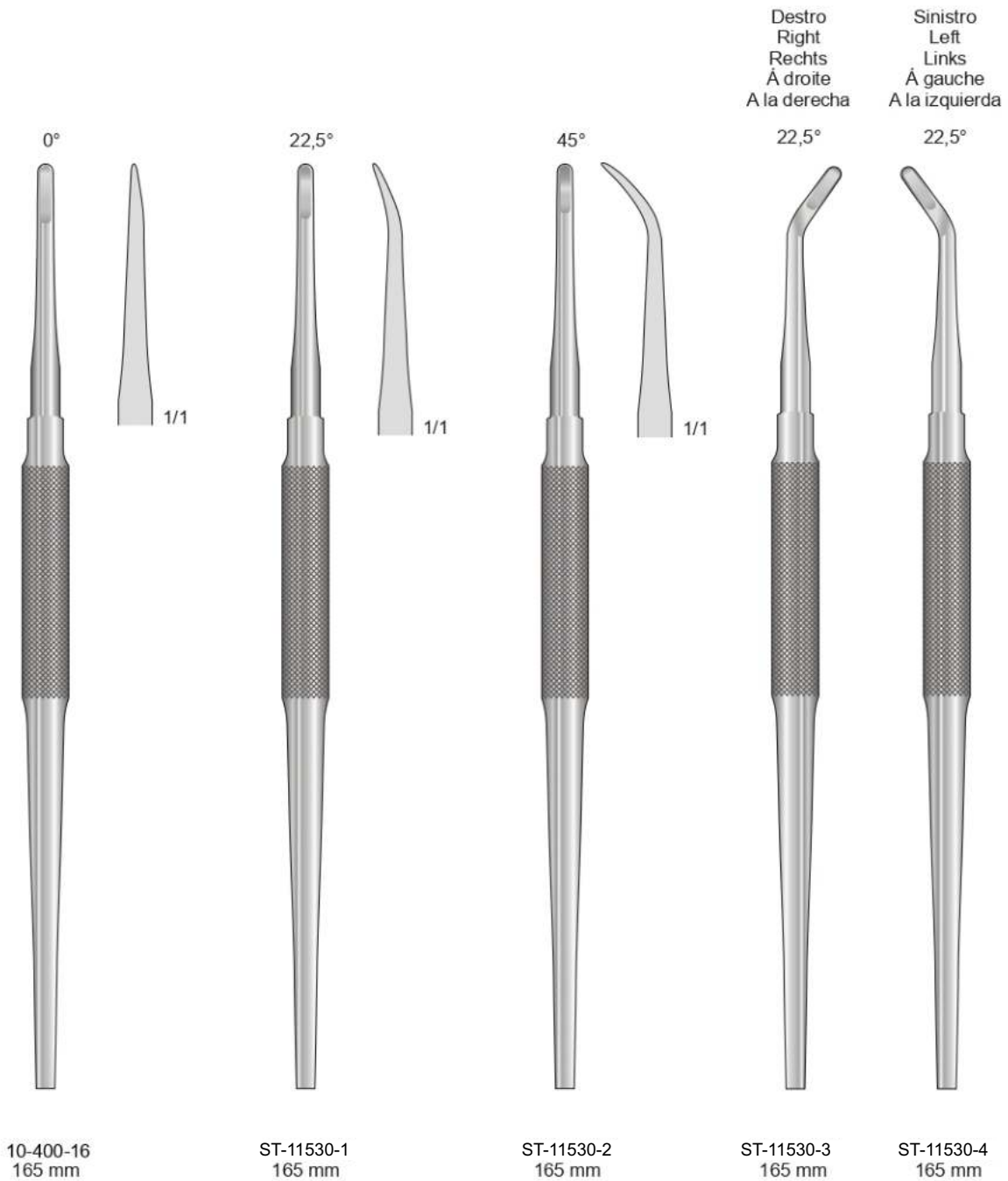
OLIVECRONA
ST-11525-1 - 180mm
ST-11525-2 - 240mm

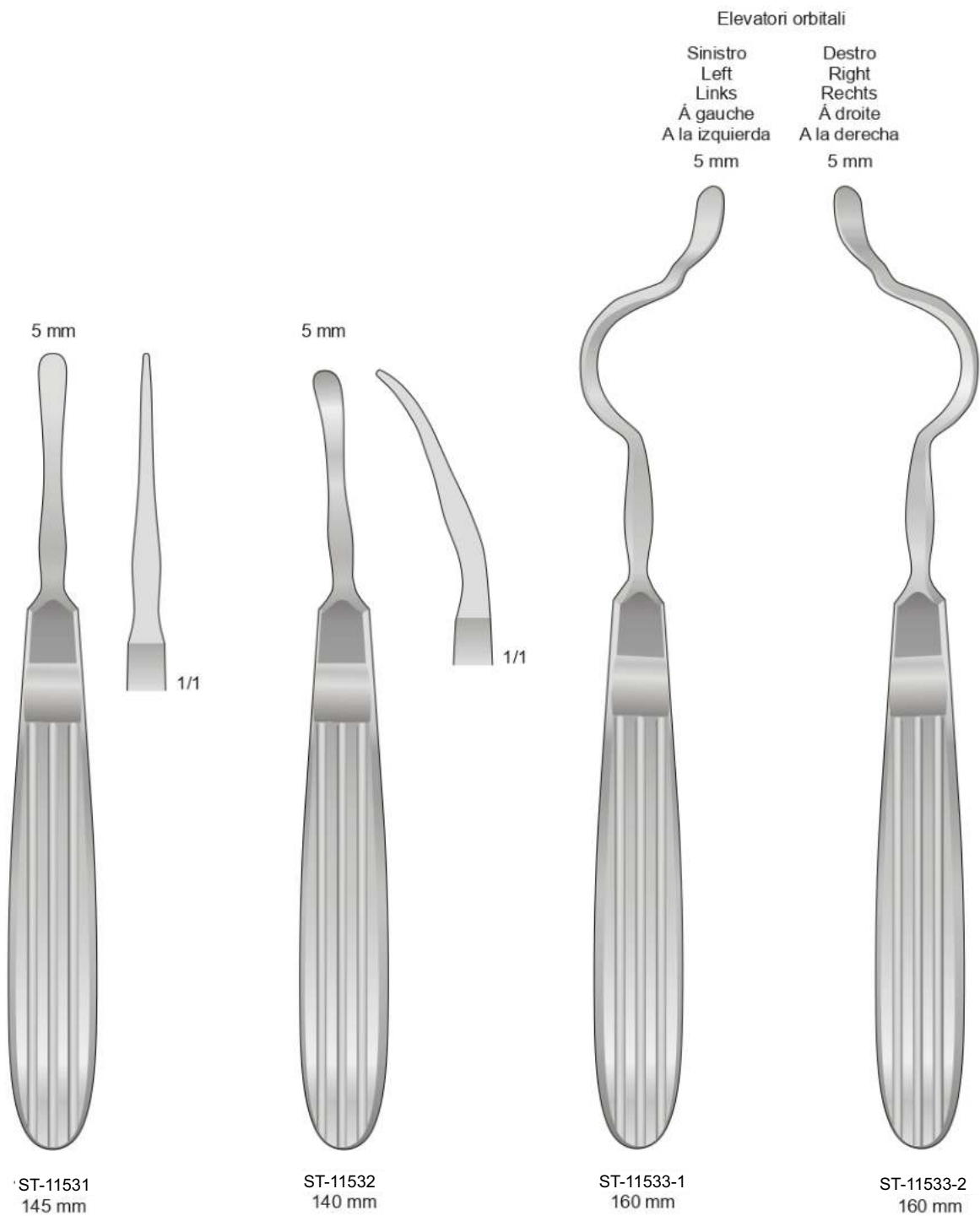
OLIVECRONA
ST-11525-3 - 195mm
ST-11525-4 - 240mm

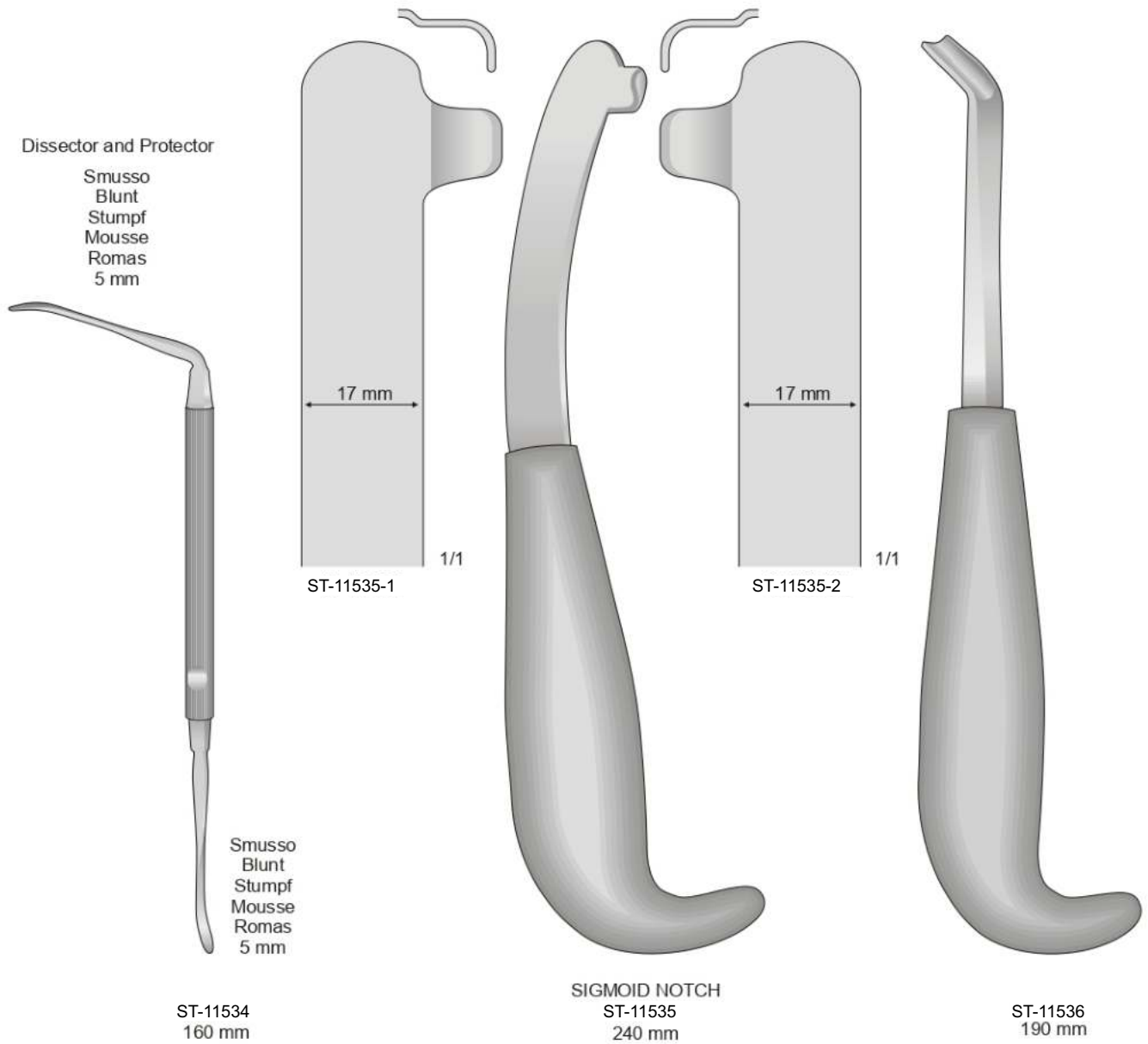


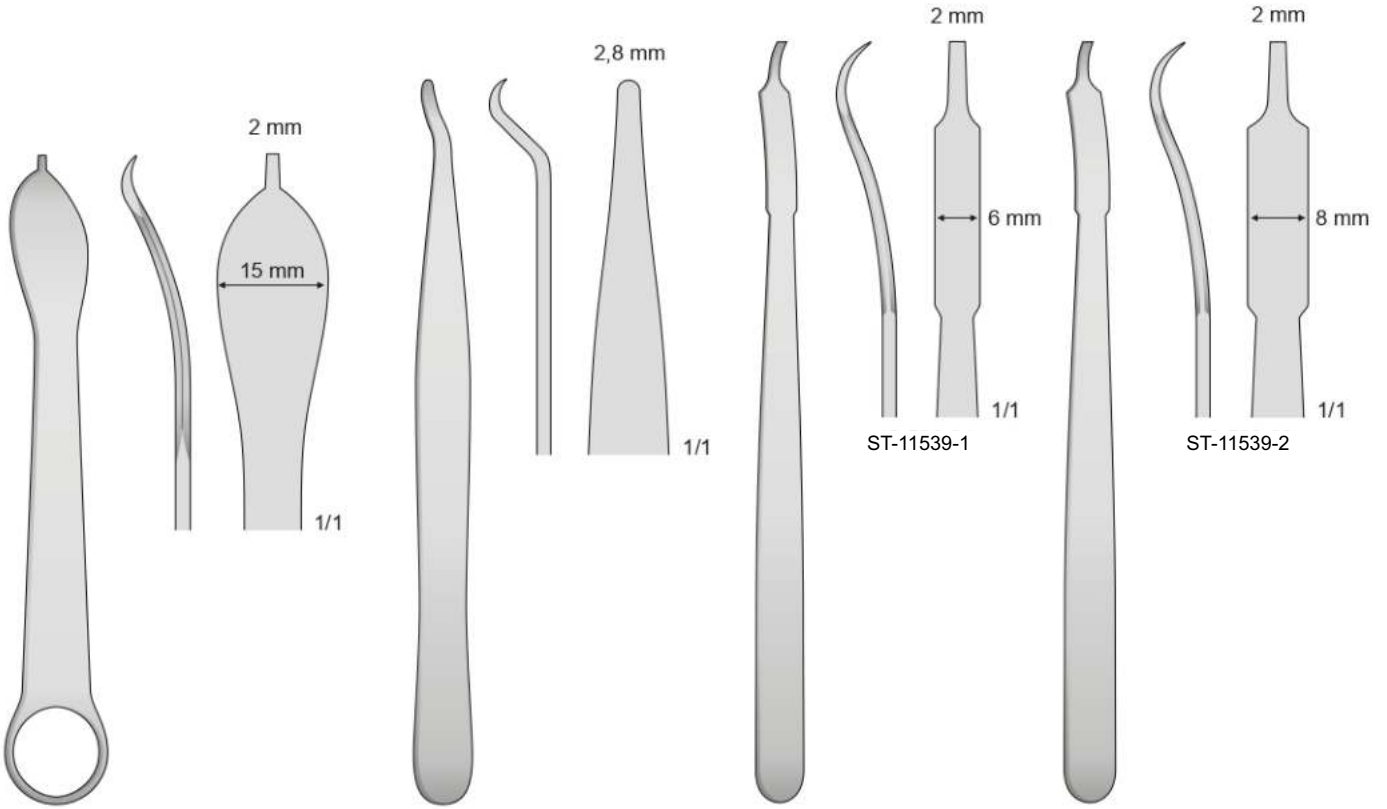


Nerve protectors







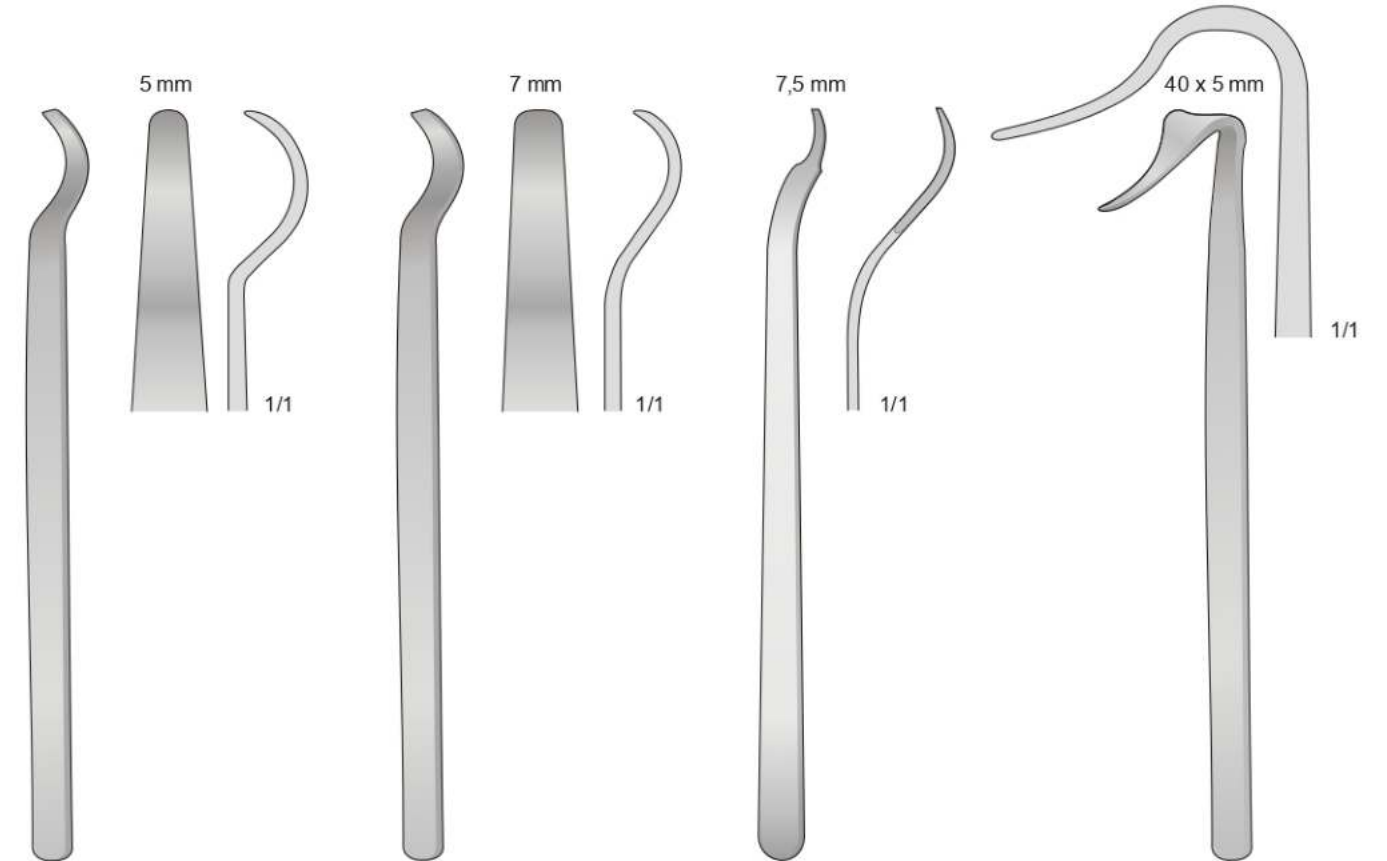


ST-11537
120 mm

ST-11538
140 mm

MINI-HOHMANN
ST-11539-1
160 mm

MINI-HOHMANN
ST-11539-2
160 mm

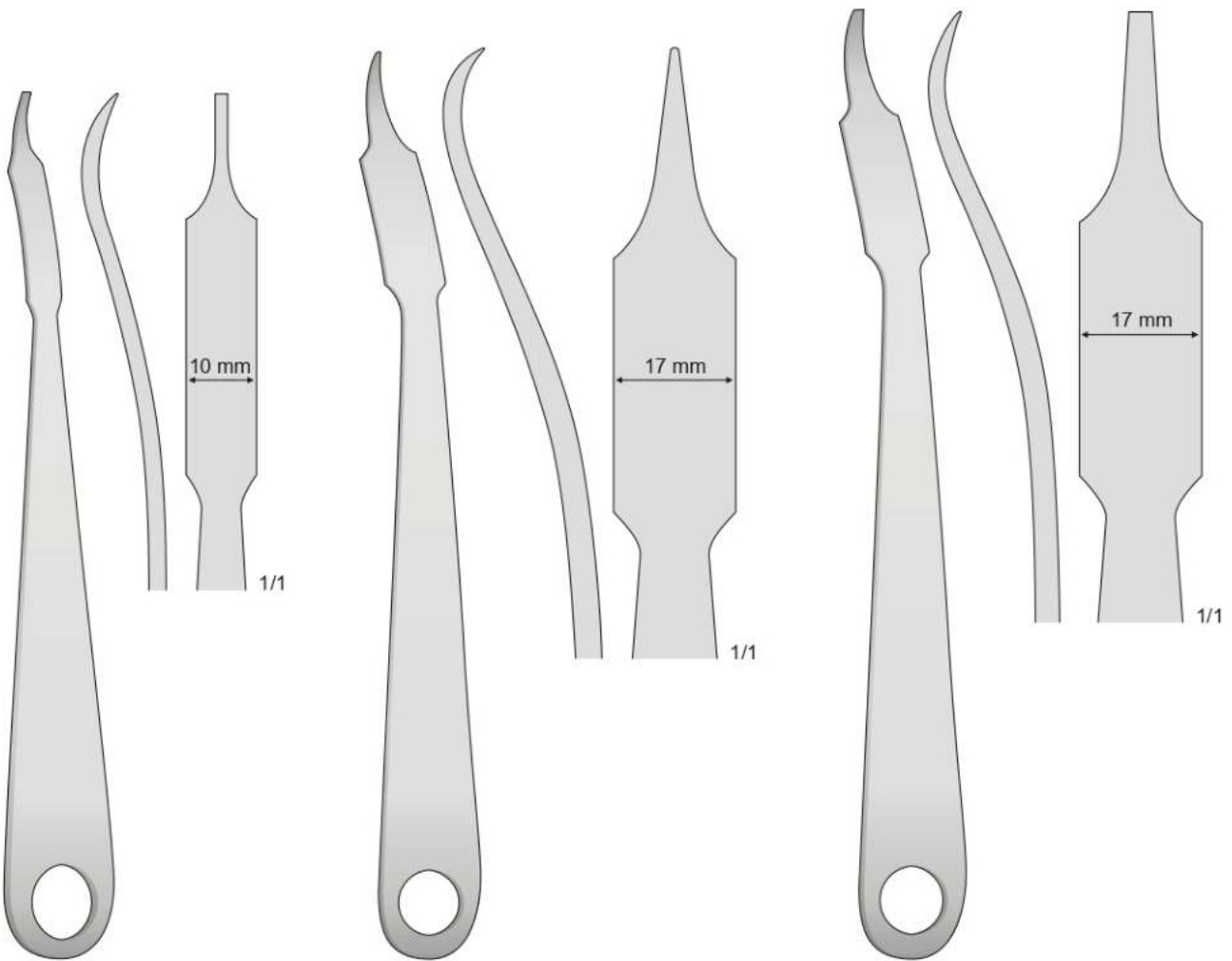


ST-11540
150 mm

ST-11541
150 mm

BUCK-GRAMCKO
ST-11542
150 mm

BLOUNT
ST-11543
175 mm



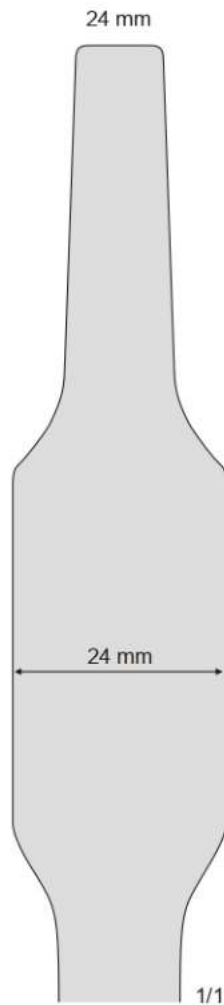
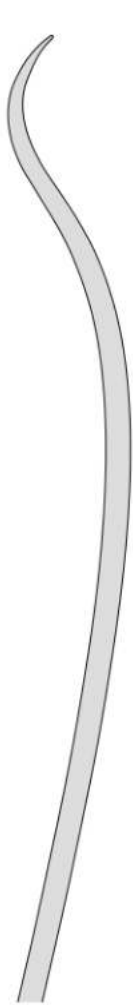
ST-11544-1
220 mm

ST-11544-2
240 mm

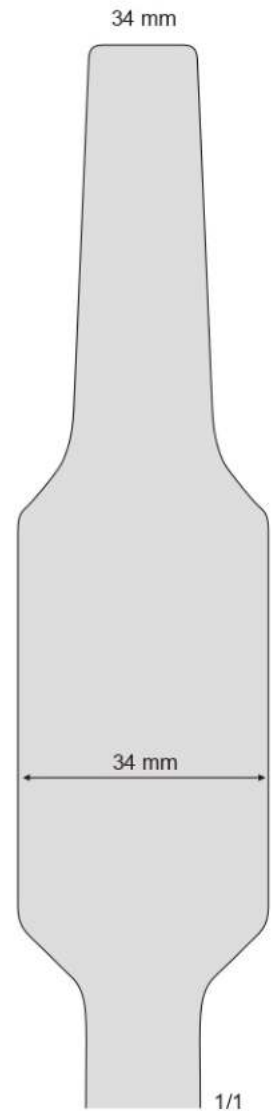
ST-11544-3
240 mm



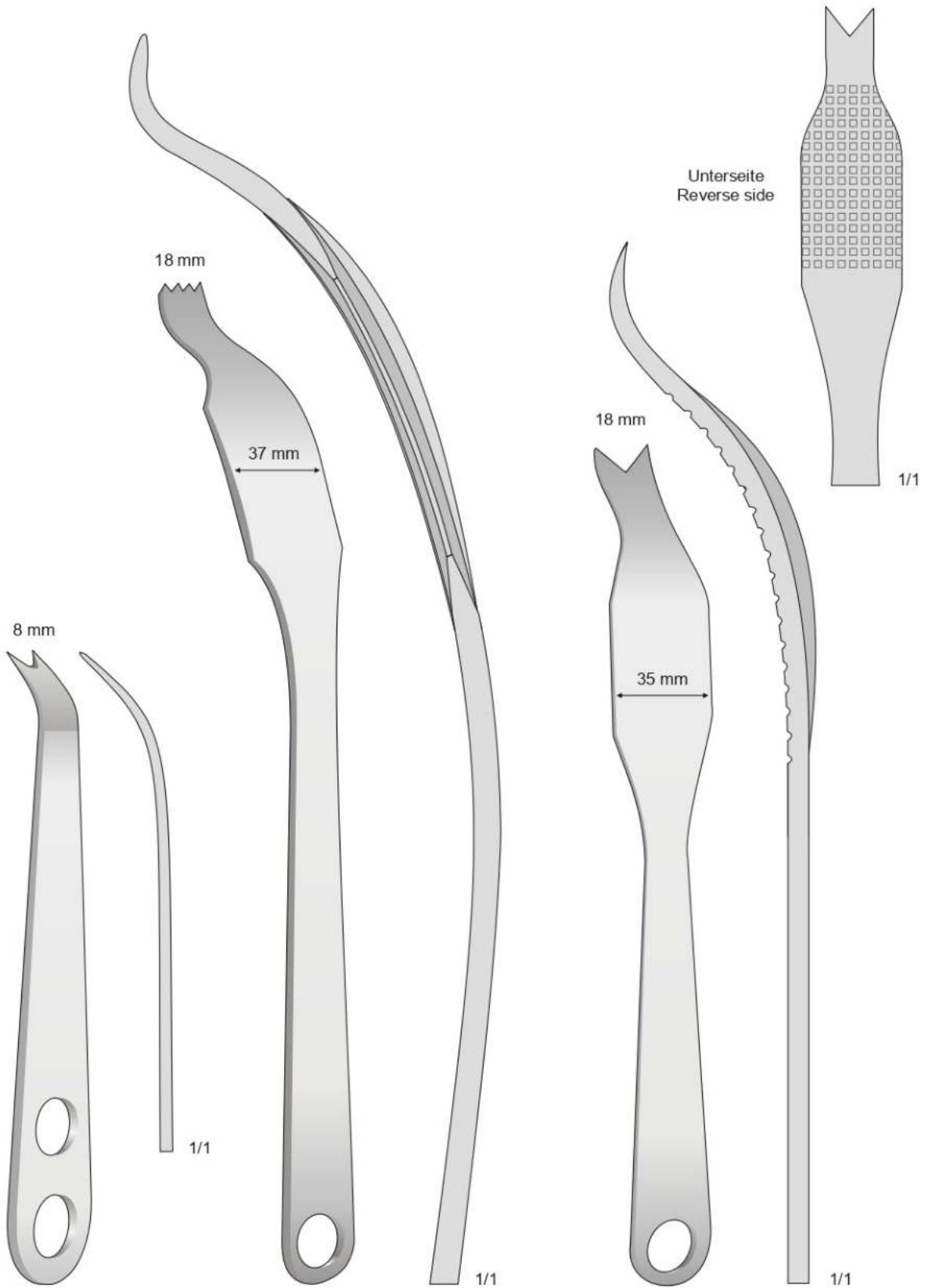
HOHMANN
ST-11545



ST-11545-1
260 mm



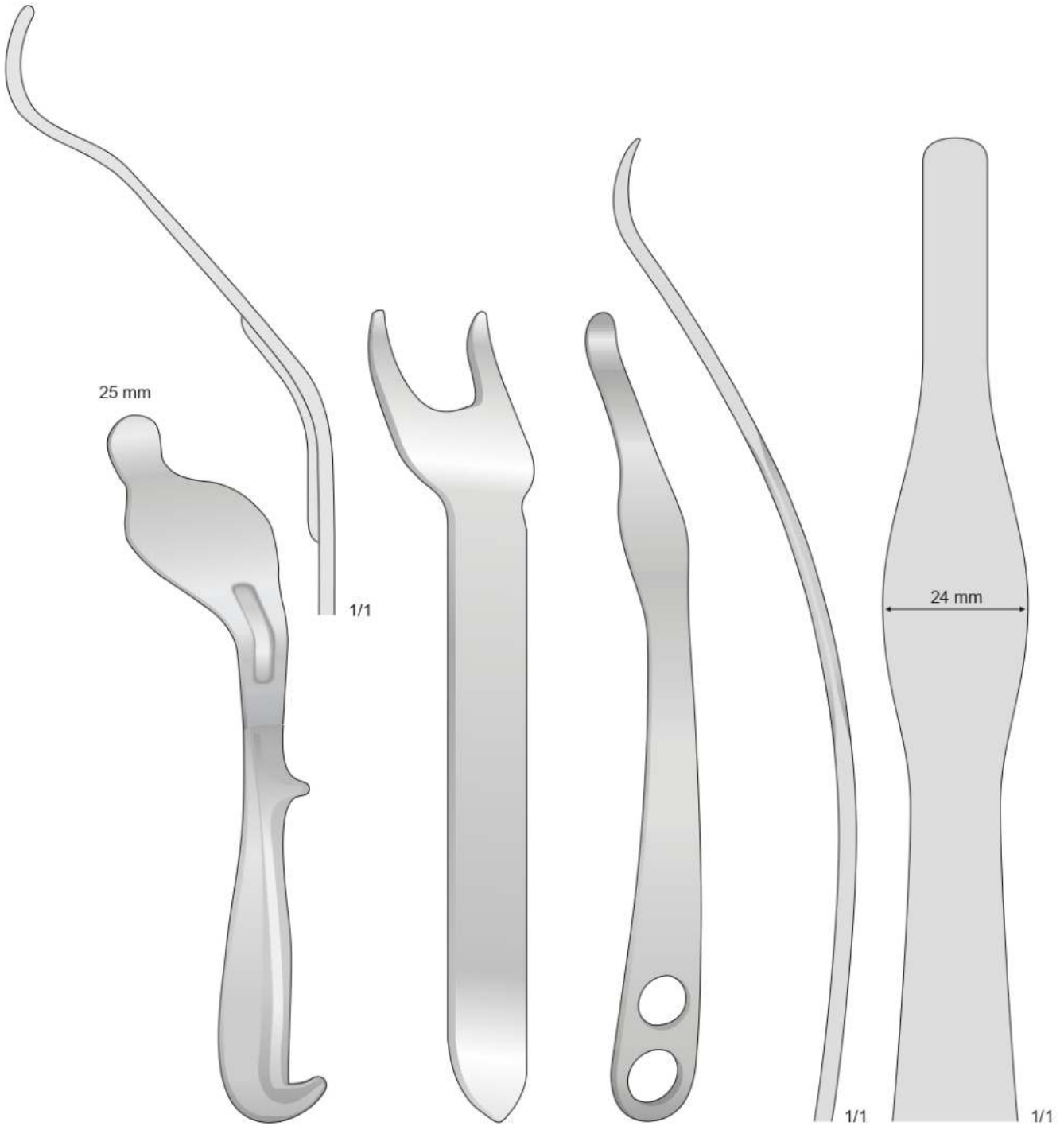
ST-11545-2
285 mm



ST-11546
140 mm

SCHUMACHER mod. WAGNER
ST-11547
345 mm

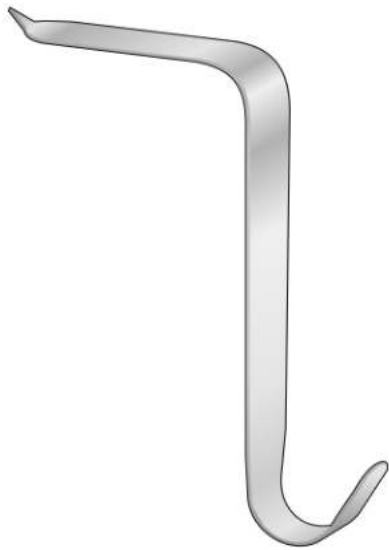
SCHUMACHER
ST-11548
285 mm



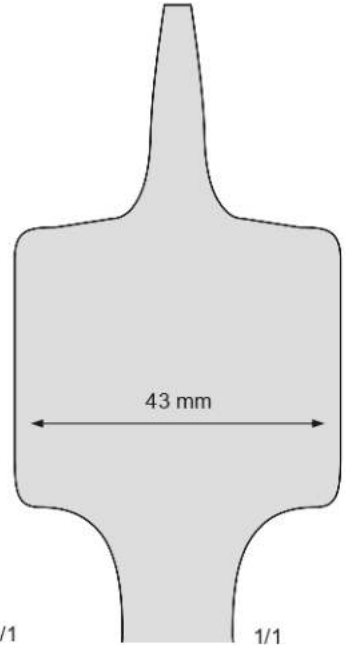
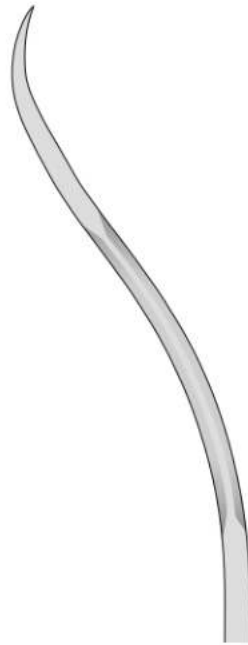
BENNETT
ST-11549-1 43 mm
ST-11549-2 60 mm
240 mm

BLOUNT
ST-11550
260 mm

ST-11551
260 mm



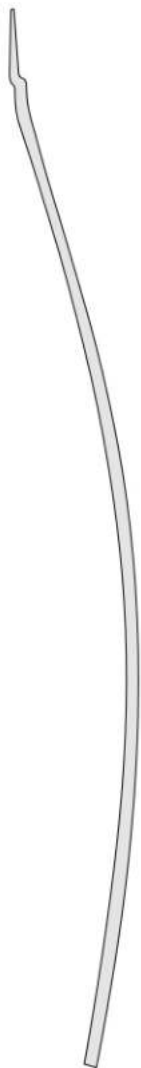
TAYLOR
10-610-01 75 x 30 mm
ST-11552-2 100 x 30 mm
165 mm



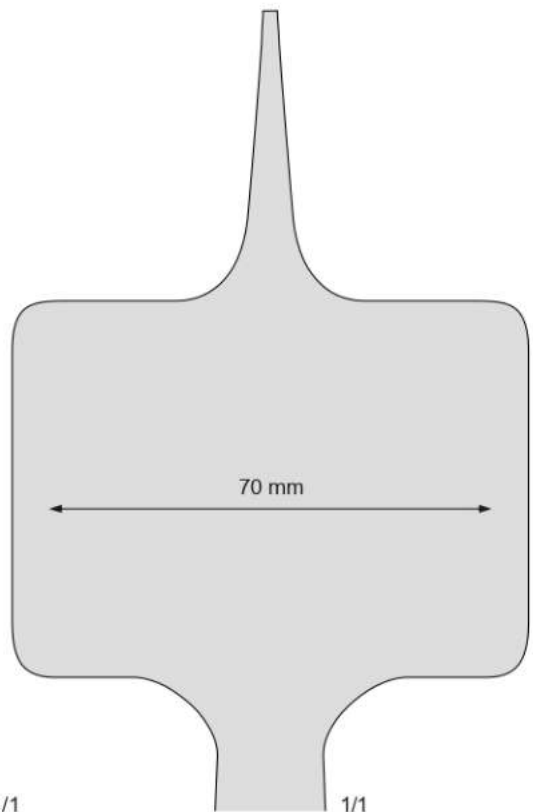
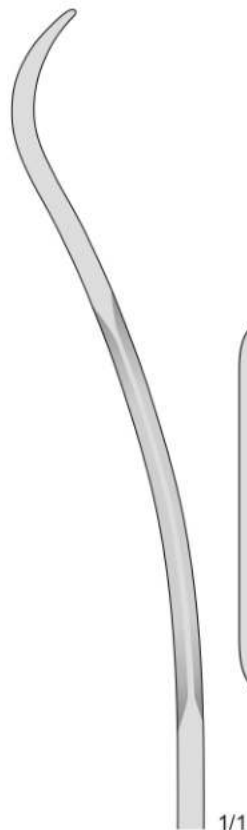
ST-11554-1
240 mm



ST-11553
250 mm



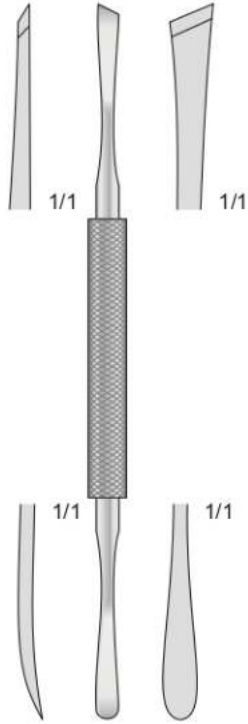
HOHMANN
ST-11554
240 mm



ST-11554-2
240 mm



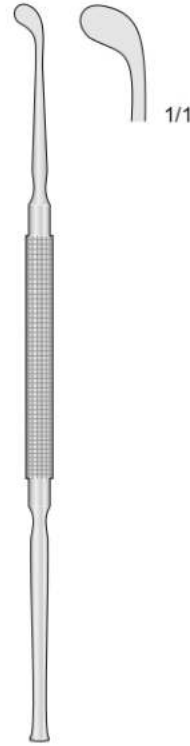
ST-11555
185 mm



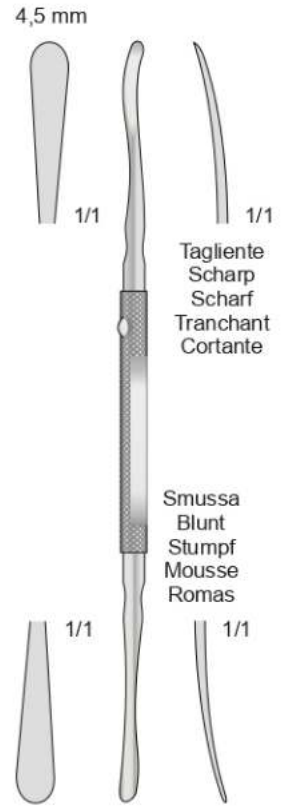
10-650-16
165 mm



ALDERDYCE
ST-11557
210 mm



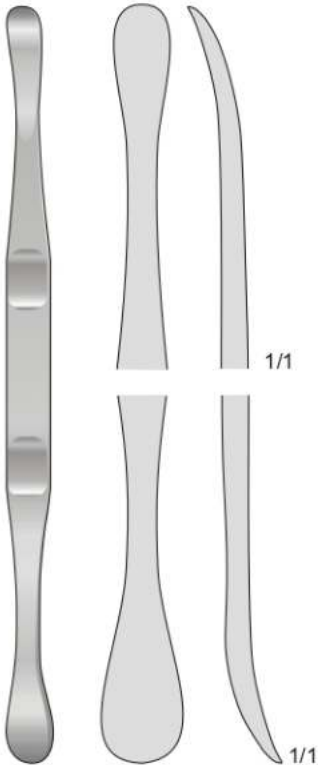
FREER
ST-11558
190 mm



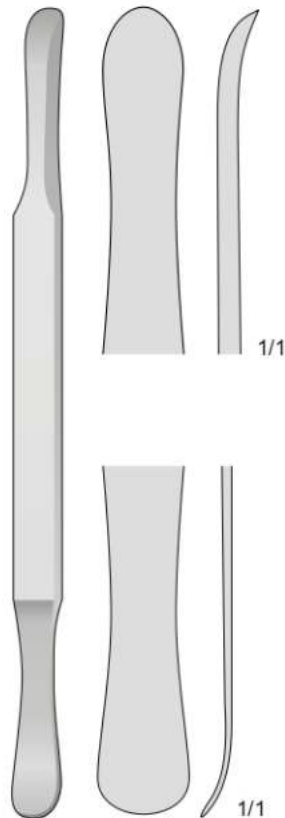
ST-11559
180 mm

Tagliente
Scharp
Scharf
Tranchant
Cortante

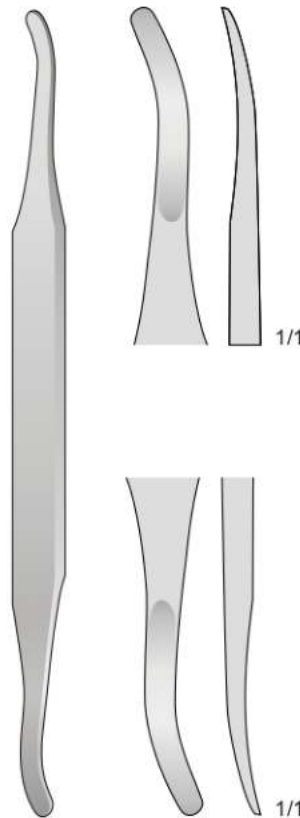
Smussa
Blunt
Stumpf
Mousse
Romas



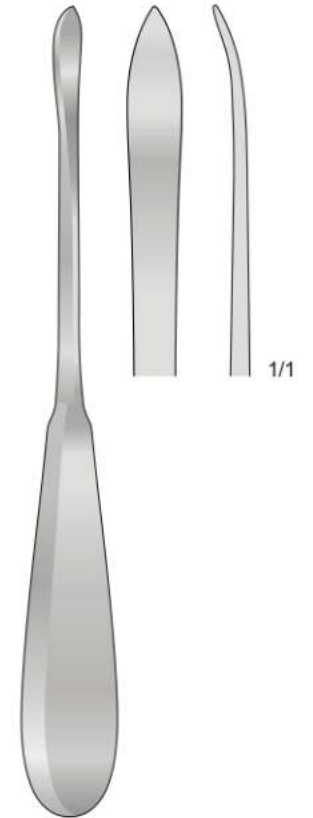
BABBUSH
ST-11560
180 mm



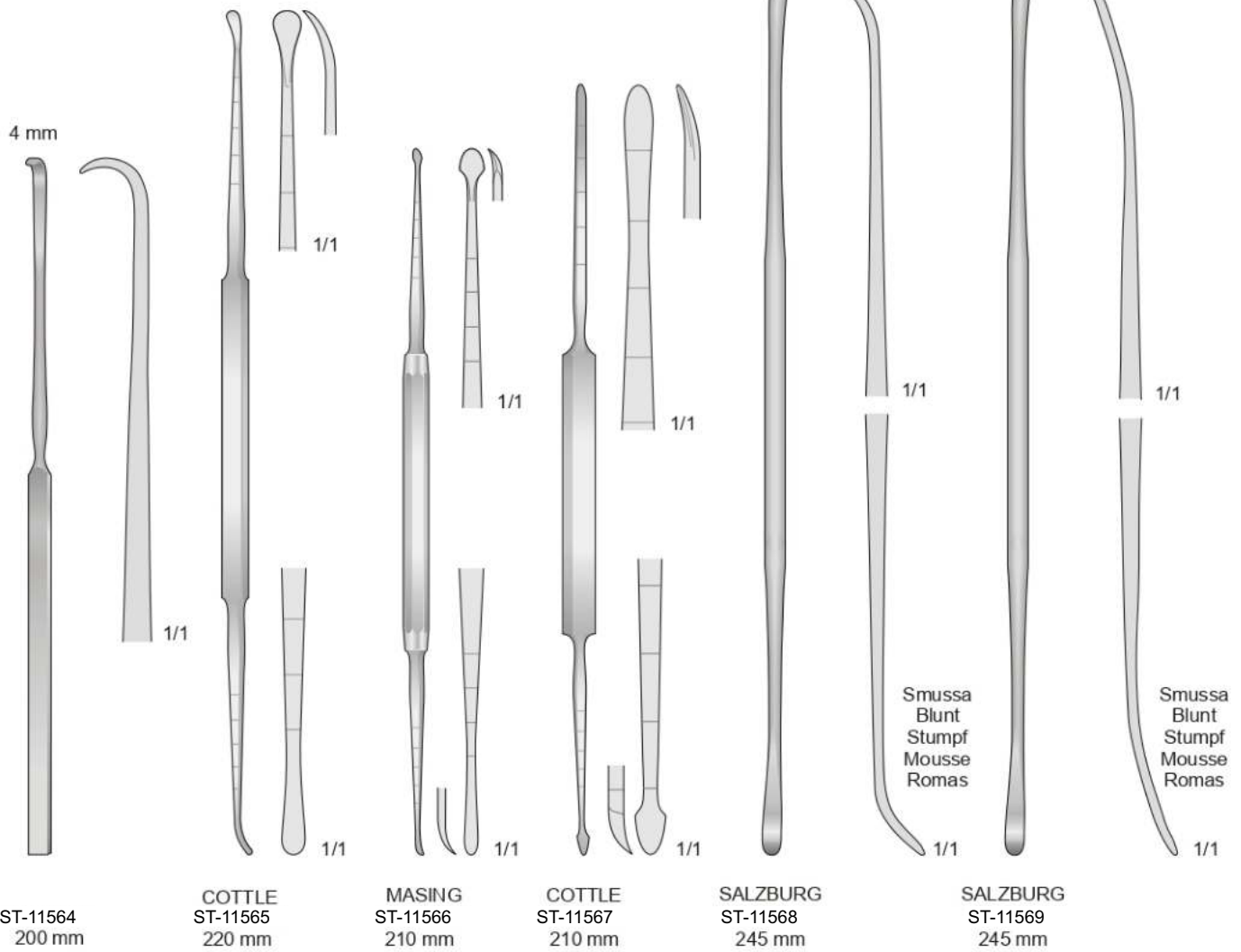
SELDIN
ST-11561
195 mm



SELDIN
ST-11562
190 mm



LANGENBECK
ST-11563
200 mm

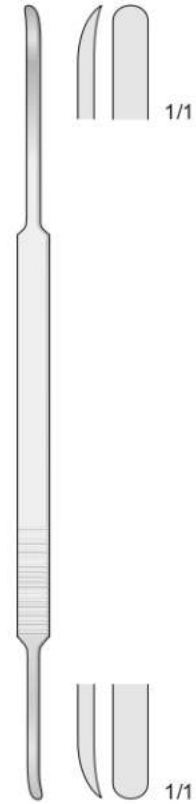




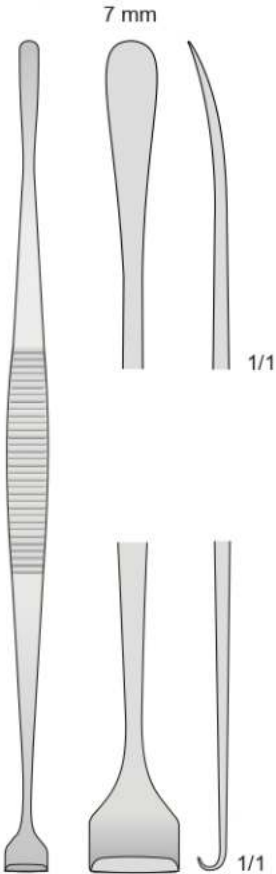
HOWARTH
ST-11570
210 mm



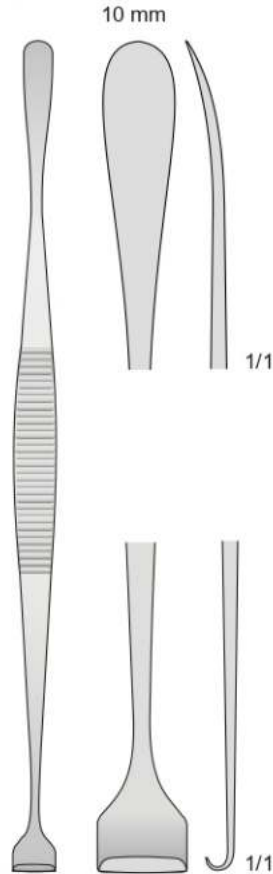
MC DONALD
ST-11571
190 mm



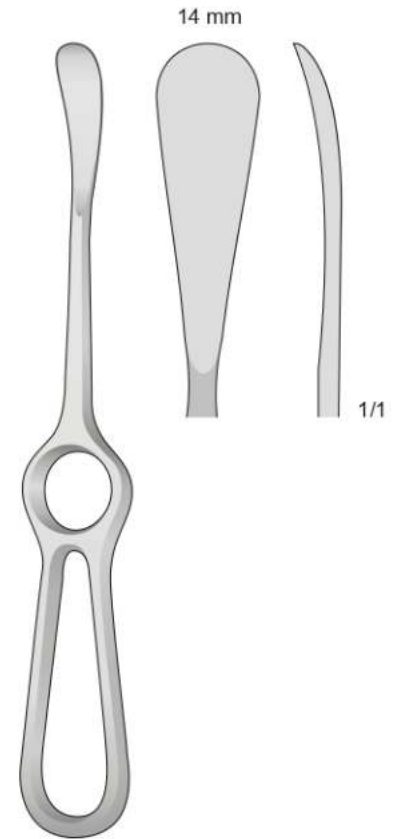
MCKENTY
ST-11572
220 mm



HURD
ST-11573-1
220 mm



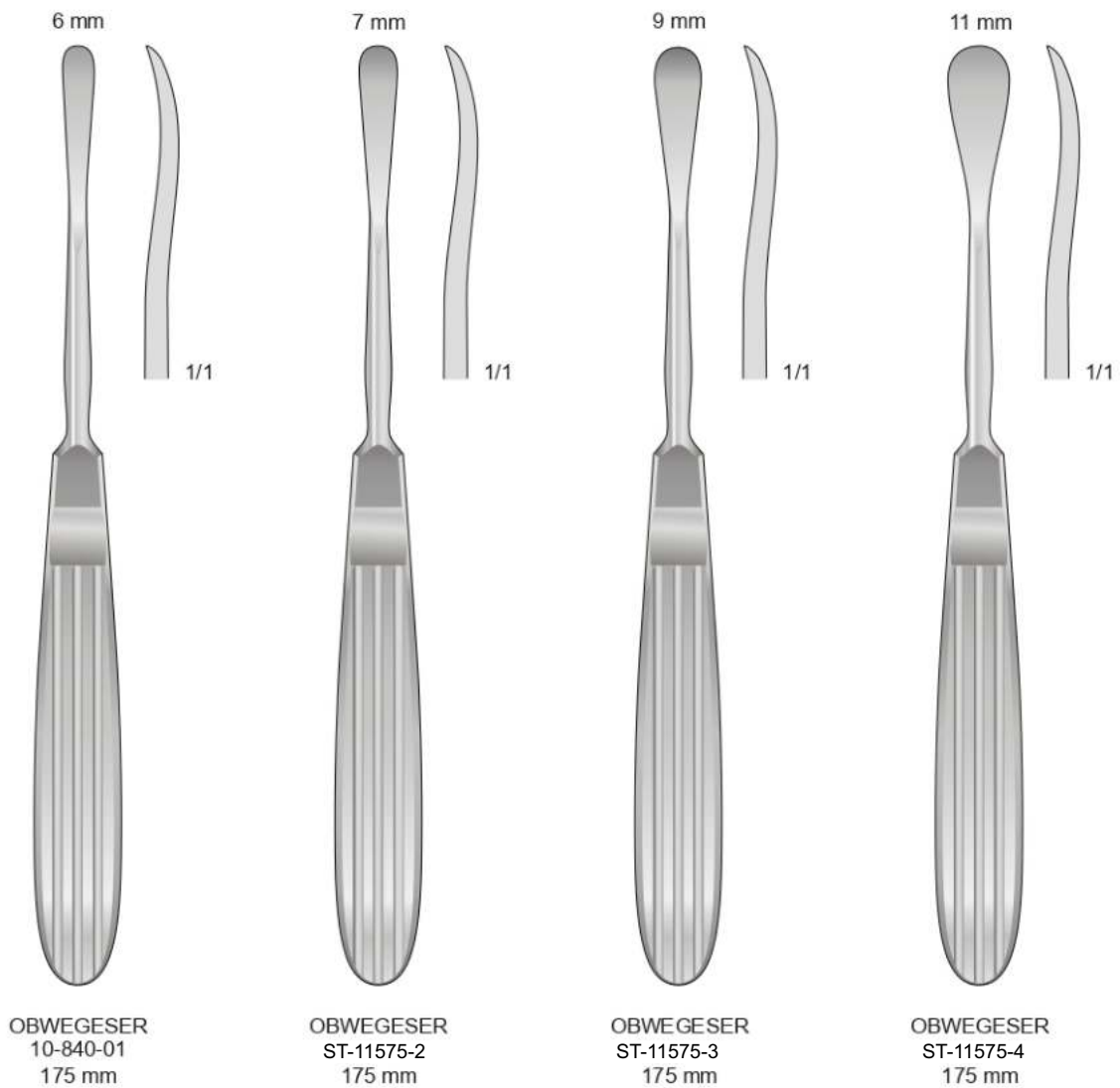
HURD
ST-11573-2
220 mm



SEDILLOT
ST-11574
210 mm



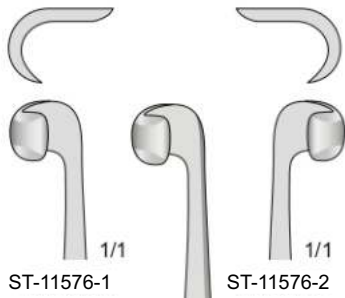
Periosteal elevators
Taglienti
Sharp
Scharf
Tranchant
Cortante



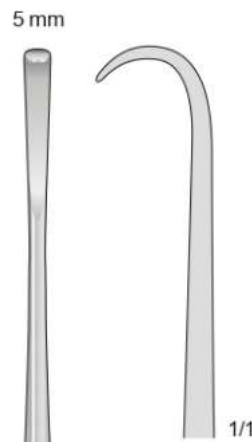


Sinistra, tagliente
Left, sharp
Links, Scharf
À gauche, tranchant
A la izquierda, cortante

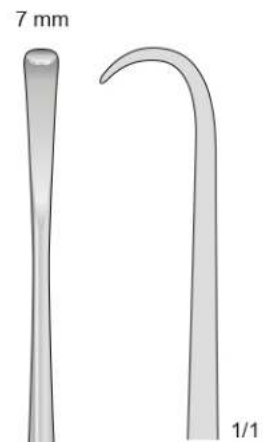
Destra, tagliente
Right, sharp
Rechts, Scharf
À droite, tranchant
A la derecha, cortante



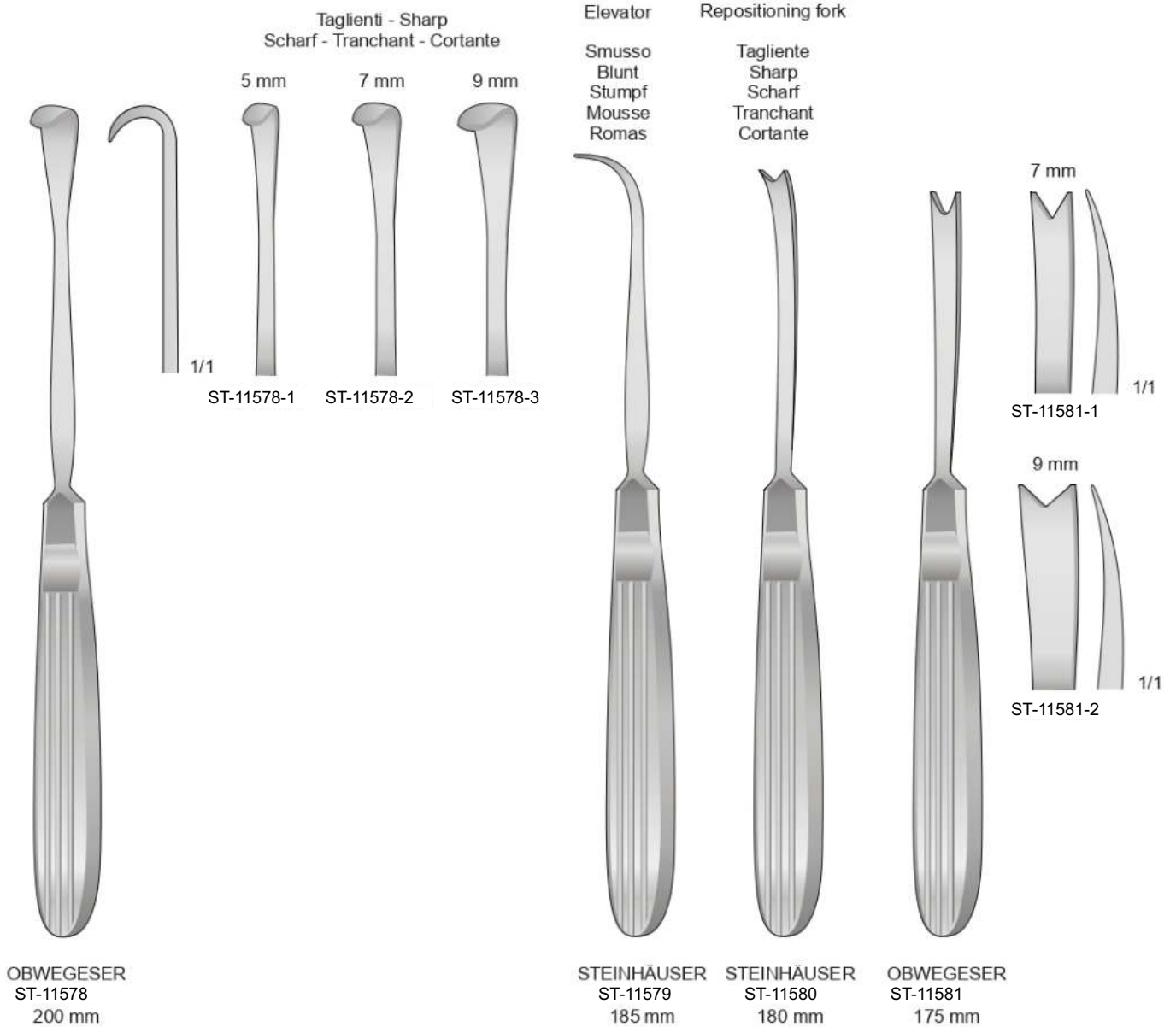
OBWEGESER
ST-11576
190 mm



ST-11577-1
200 mm



ST-11577-2
200 mm



15 mm



CUSHING
ST-11582
190 mm



ADSON
ST-11583
170 mm

8 mm



ST-11583-1

7 mm



ST-11583-2

7 mm



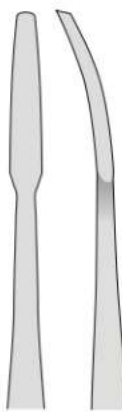
ST-11583-3

7 mm



ST-11583-4

2,5 mm

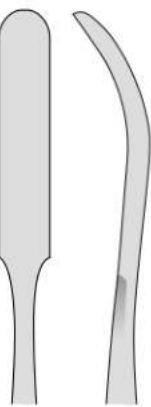


1/1



JOSEPH
ST-11584-1
170 mm

7 mm



1/1



JOSEPH
ST-11584-2
180 mm

10 mm



MOLT
ST-11585
160 mm

10 mm



1/1

12 mm



1/1

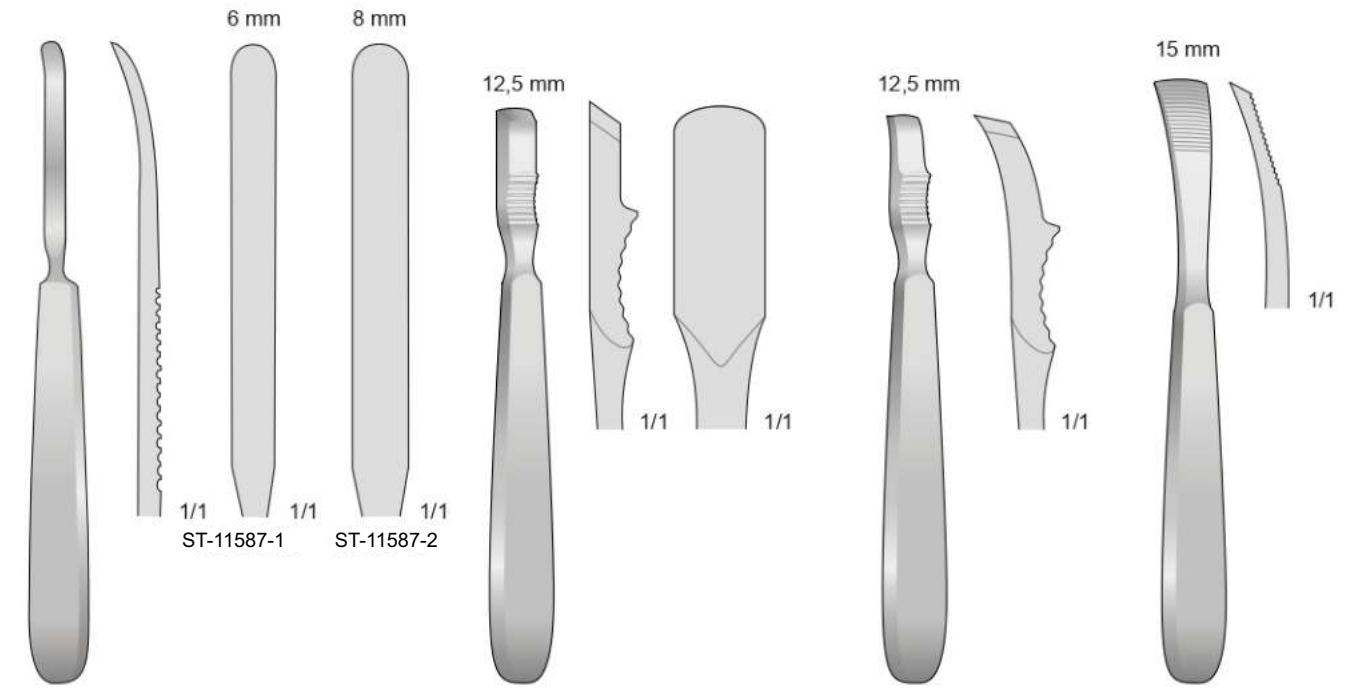
15 mm



1/1



HENAHAN
ST-11586
175 mm

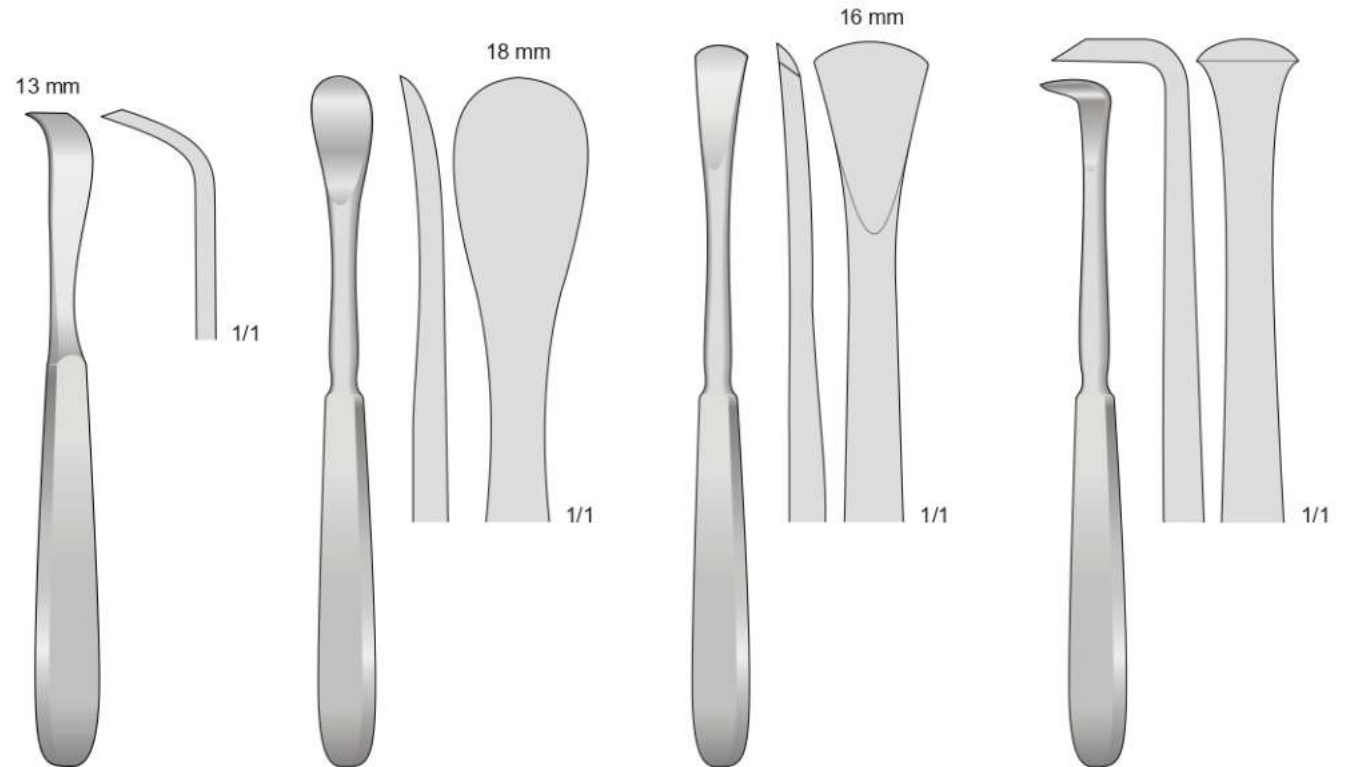


ST-11587
170 mm

FARABEUFS
ST-11588
150 mm

FARABEUFS
ST-11589
150 mm

JANSEN
ST-11590
165 mm



SCHNEIDER
ST-11591
175 mm

SEDILLOT
ST-11592
185 mm

LANGENBECK
ST-11593
190 mm

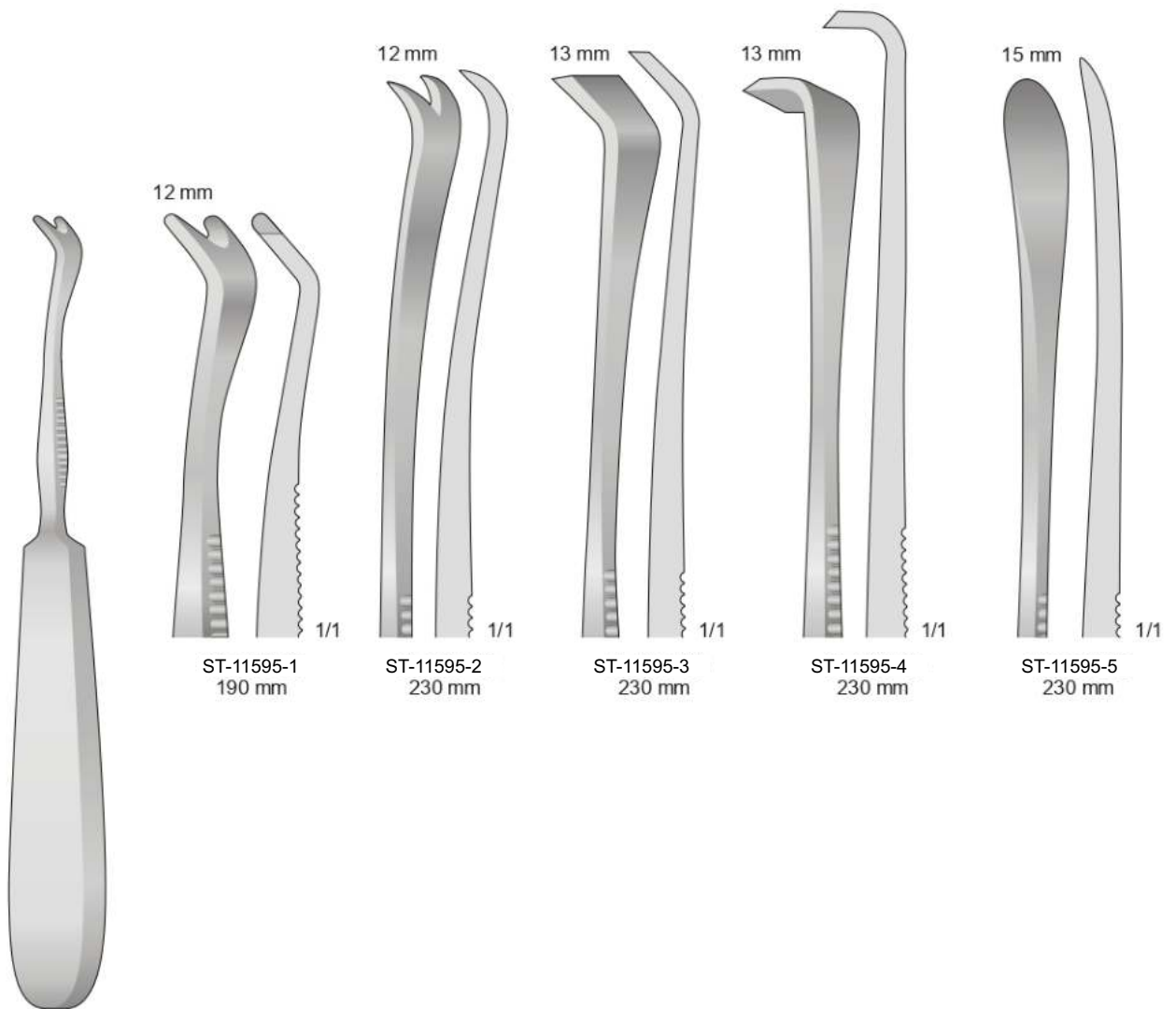
LANGENBECK
ST-11594
180 mm

Sinus
Hipophisectomia

Sinus and
Hypophisectomy

Sinus und
Hypophisectomie

Elevation e dissezion
de apofisi zigomatica



12 mm

12 mm

13 mm

13 mm

15 mm

ST-11595-1
190 mm

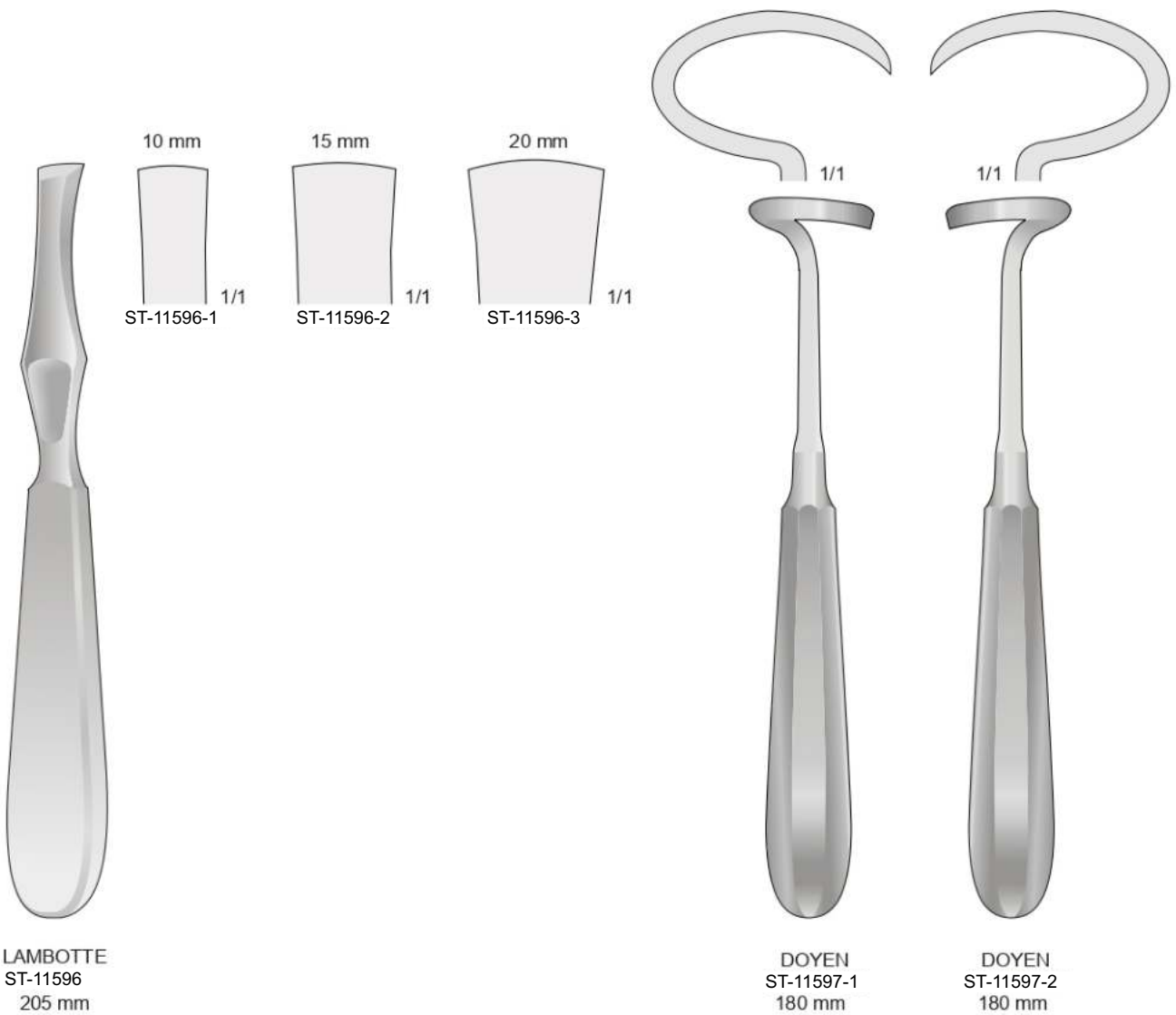
ST-11595-2
230 mm

ST-11595-3
230 mm

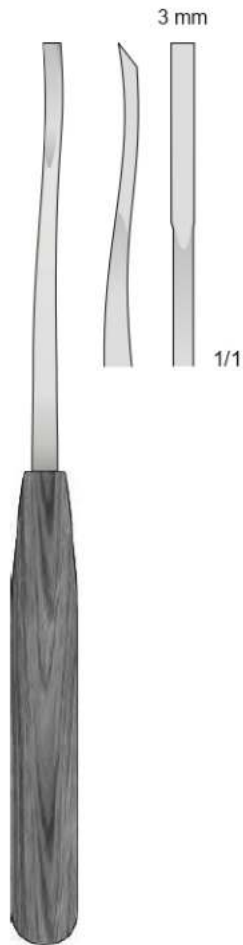
ST-11595-4
230 mm

ST-11595-5
230 mm

SEMB
ST-11595



Con manico Ferrozell
With Ferrozell handle
Mit Ferrozellgriff
Avec poignée en Ferrozell
Con mango de Ferrozell



ST-11598-1
180 mm

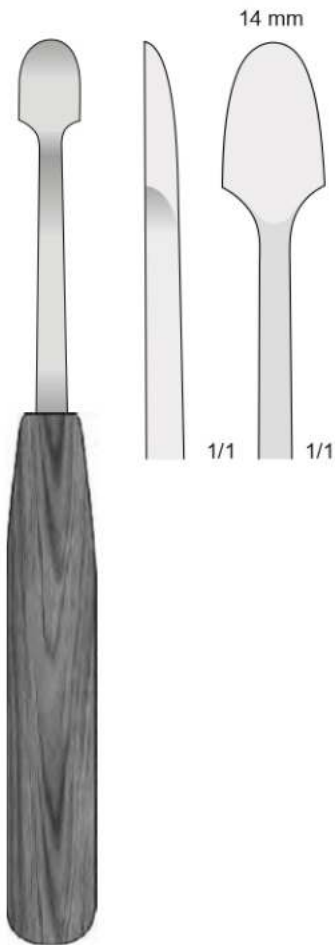


ST-11598-2
190 mm

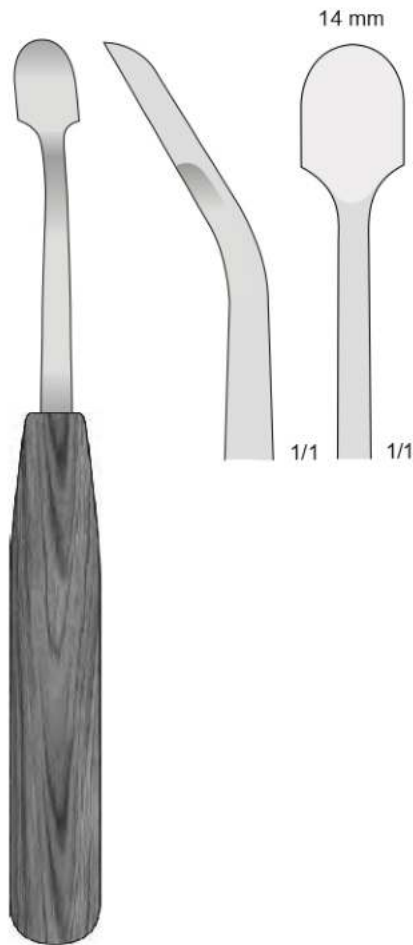


ST-11598-3
190 mm

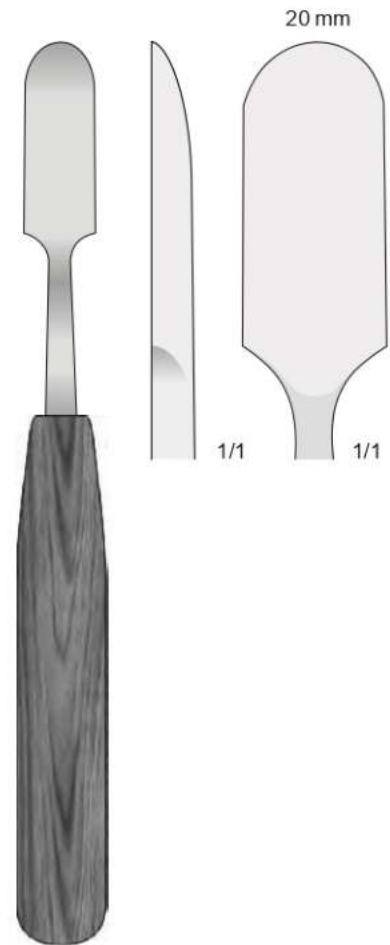
Con manico Ferrozell
With Ferrozell handle
Mit Ferrozellgriff
Avec poignée en Ferrozell
Con mango de Ferrozell



ST-11599-1
200 mm

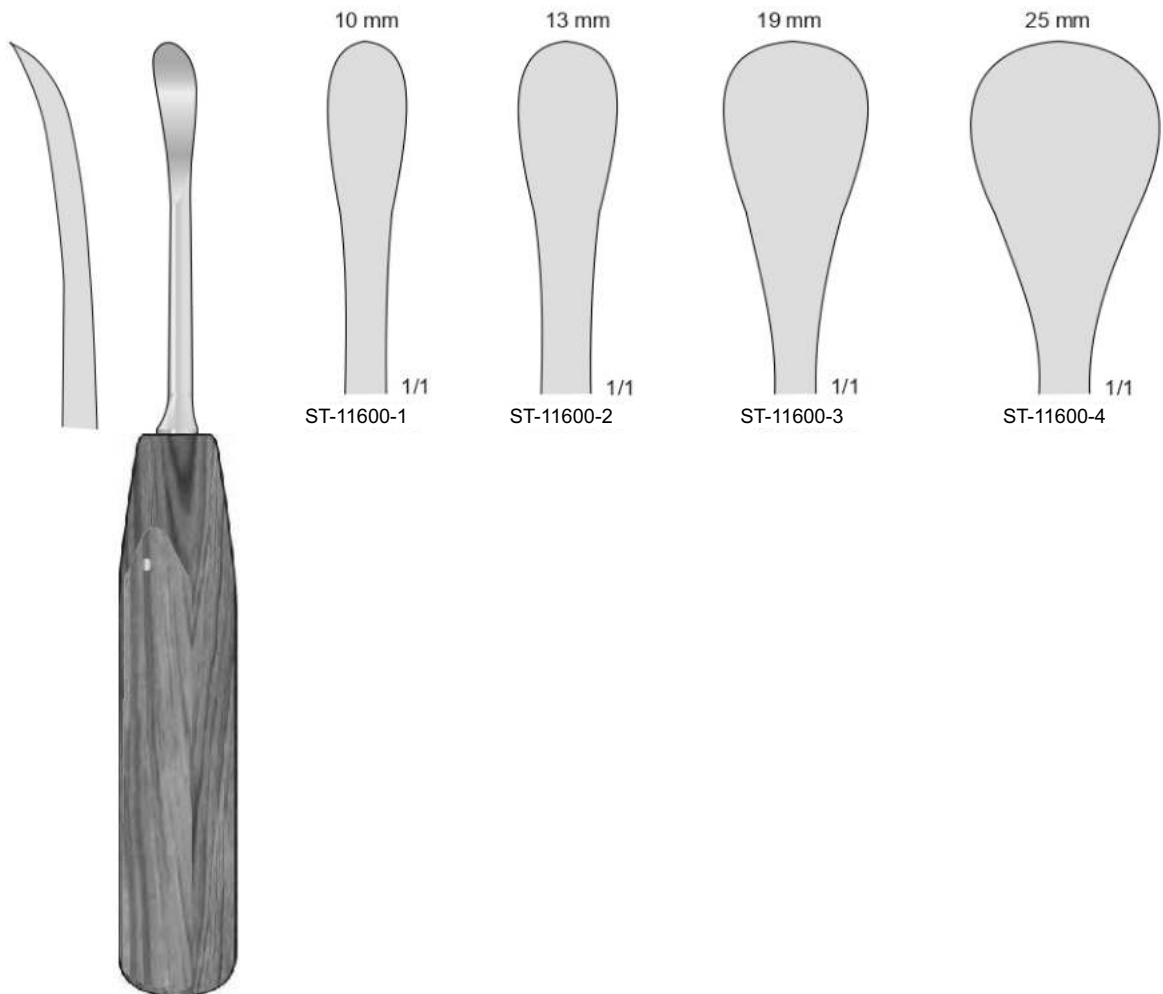


ST-11599-2
200 mm



ST-11599-3
200 mm

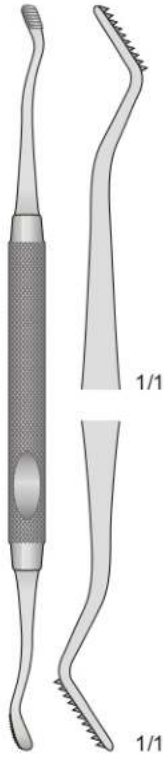
Con manico Ferrozell
With Ferrozell handle
Mit Ferrozellgriff
Avec poignée en Ferrozell
Con mango de Ferrozell



COBB
ST-11600
250 mm

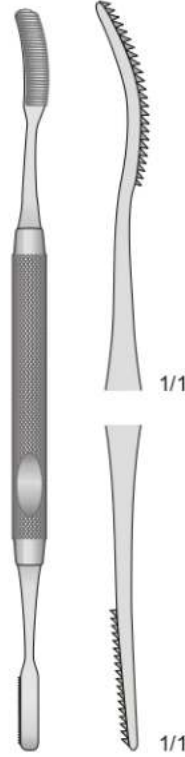


Fig. 67



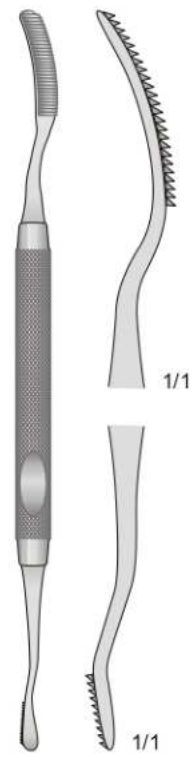
HOWARD
ST-11601
180 mm

Fig. 45

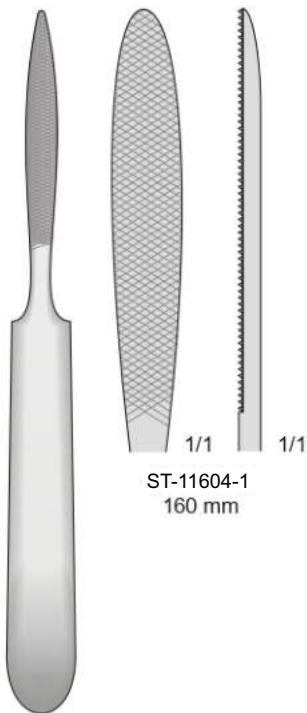


MILLER
ST-11602
185 mm

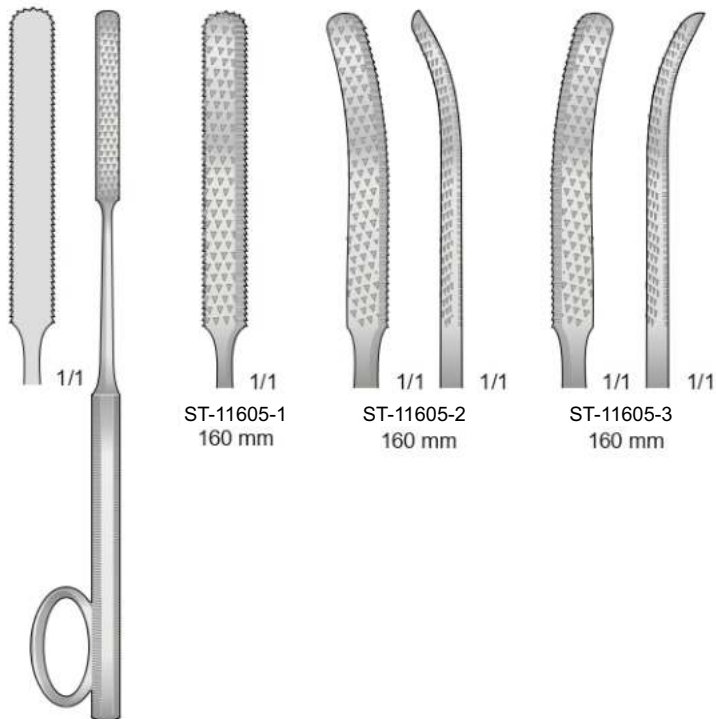
Fig. 52



MILLER
ST-11603
180 mm



JOSEPH
ST-11604
160 mm



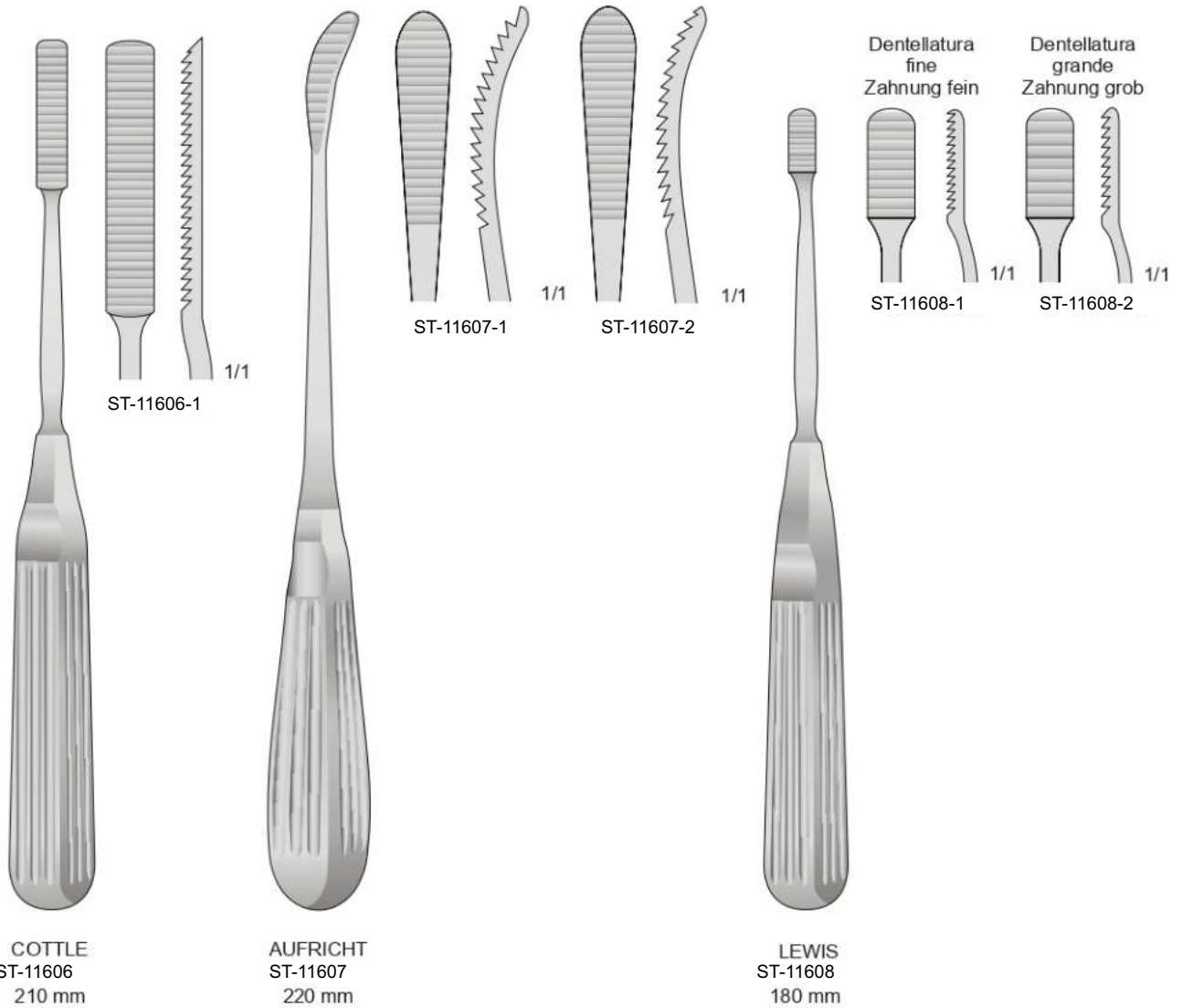
GALLAHER
ST-11605
160 mm

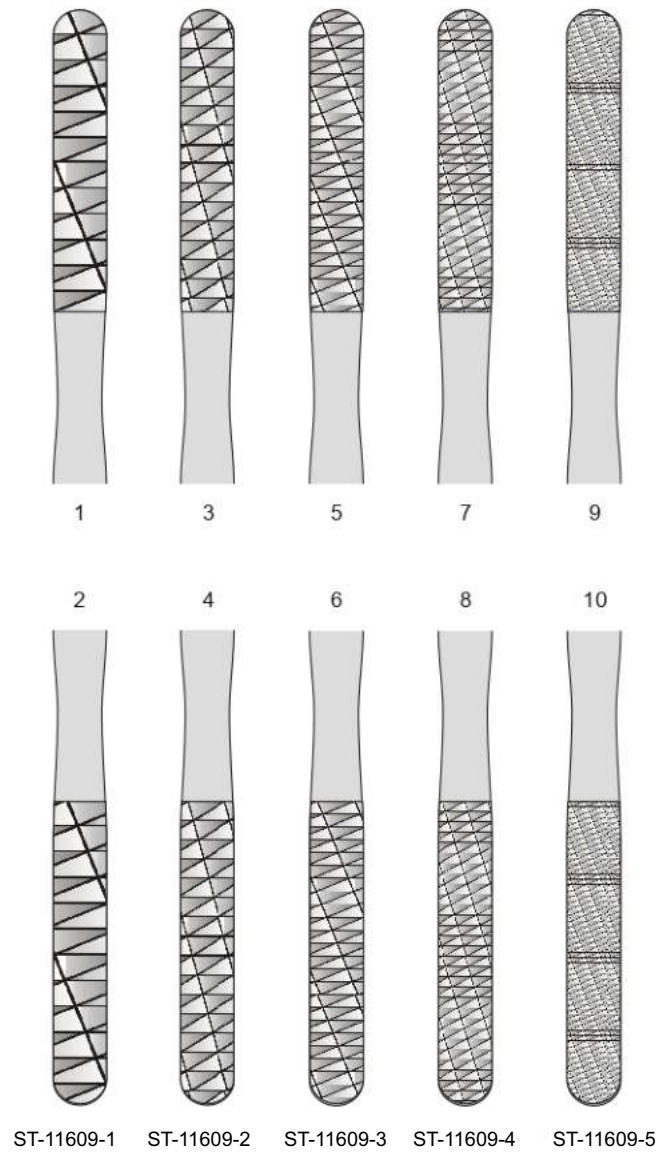
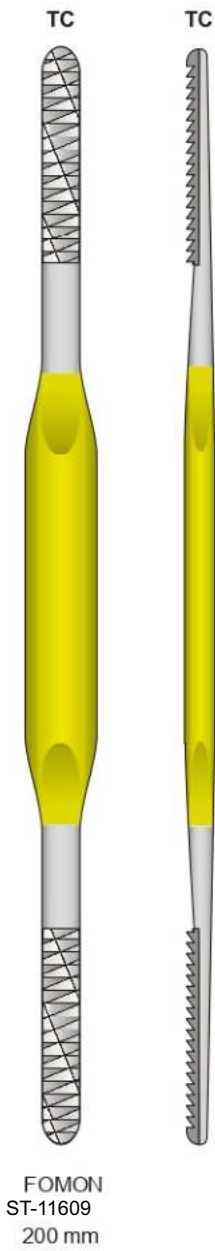
ST-11604-1
160 mm

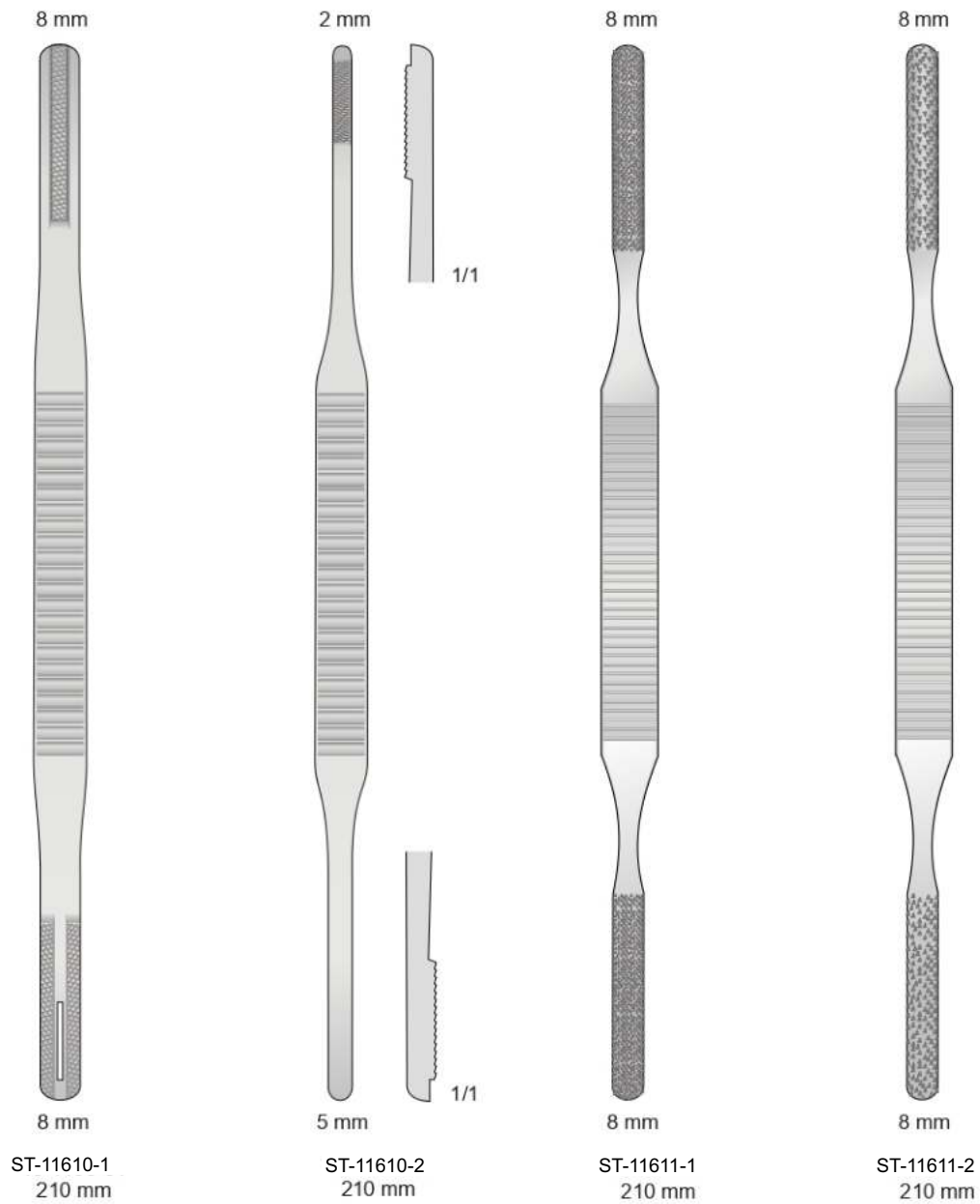
ST-11605-1
160 mm

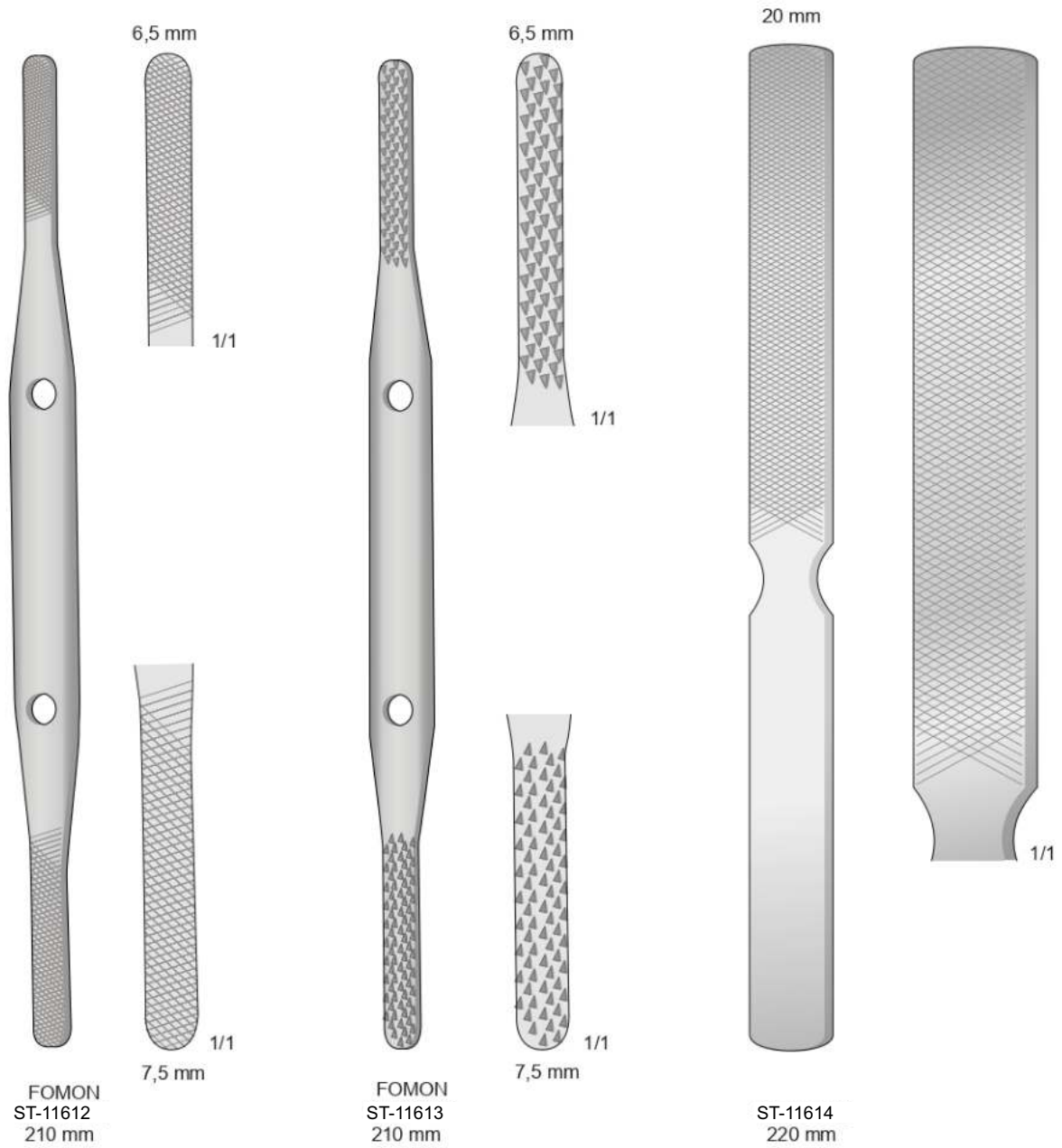
ST-11605-2
160 mm

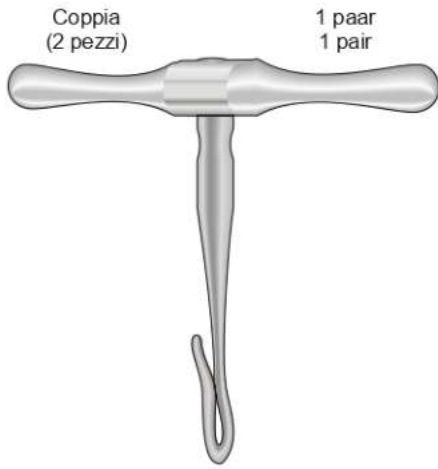
ST-11605-3
160 mm







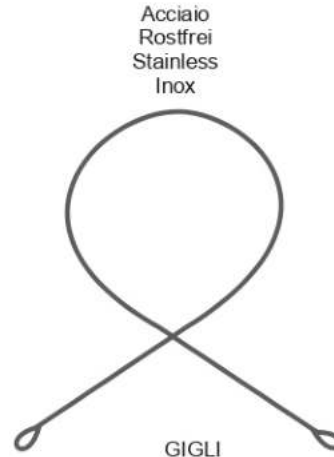




Coppia
(2 pezzi)

1 paar
1 pair

GIGLI
ST-11619



Acciaio
Rostfrei
Stainless
Inox

GIGLI
ST-11620-1
300 mm
ST-11620-2
500 mm

Completa con 3 seghe
Complete with 3 saws
Komplett mit 3 Sägen
Complet avec 3 scies
Completo con 3 sierras



COLLIN
ST-11621
390 mm

Fig.1

Fig.2

Fig.3



ST-11621-1
280 mm

ST-11621-2
280 mm

ST-11621-3
280 mm



1/1

LINDEMANN
ST-11622
200 mm



LANGENBECK
ST-11623
235 mm



HEMINGWAY
ST-11624
175 mm



HEMINGWAY
ST-11625
175 mm



HEMINGWAY
ST-11626
175 mm



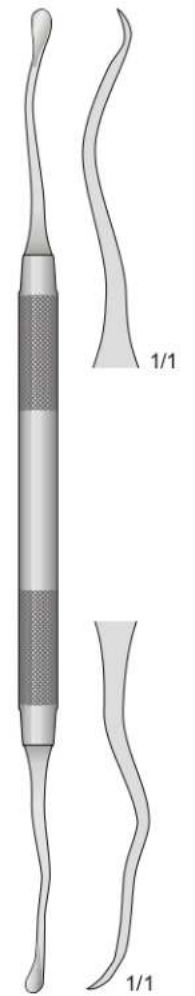
HEMINGWAY
ST-11627
175 mm

Fig. 1

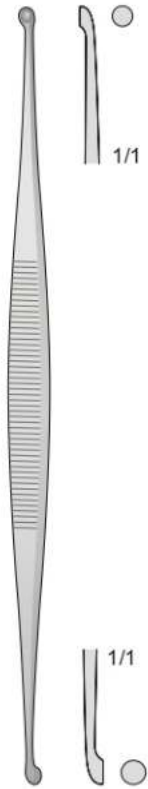


10-1350-02
200 mm

Fig. 2



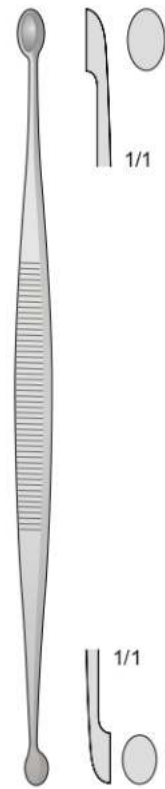
ST-11629
195 mm



MARTINI
10-1360-14
140 mm



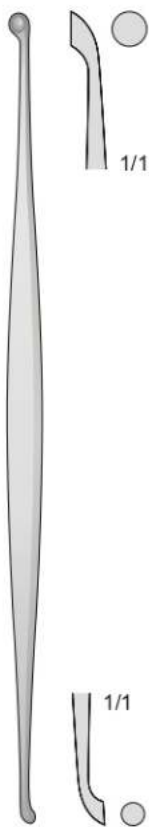
WILLIGER
10-1370-14
145 mm



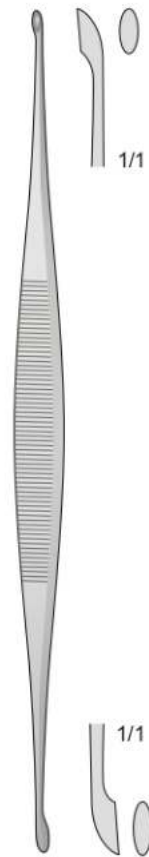
JACOBSON
10-1380-14
140 mm



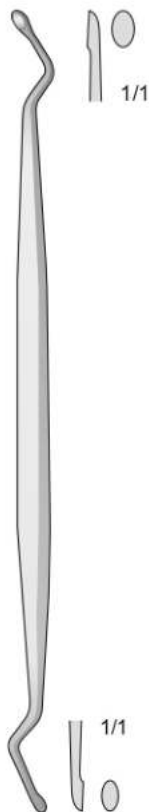
MARTINI
10-1390-14
140 mm



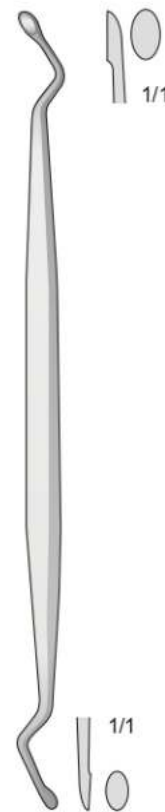
JANSEN
ST-11634
160 mm



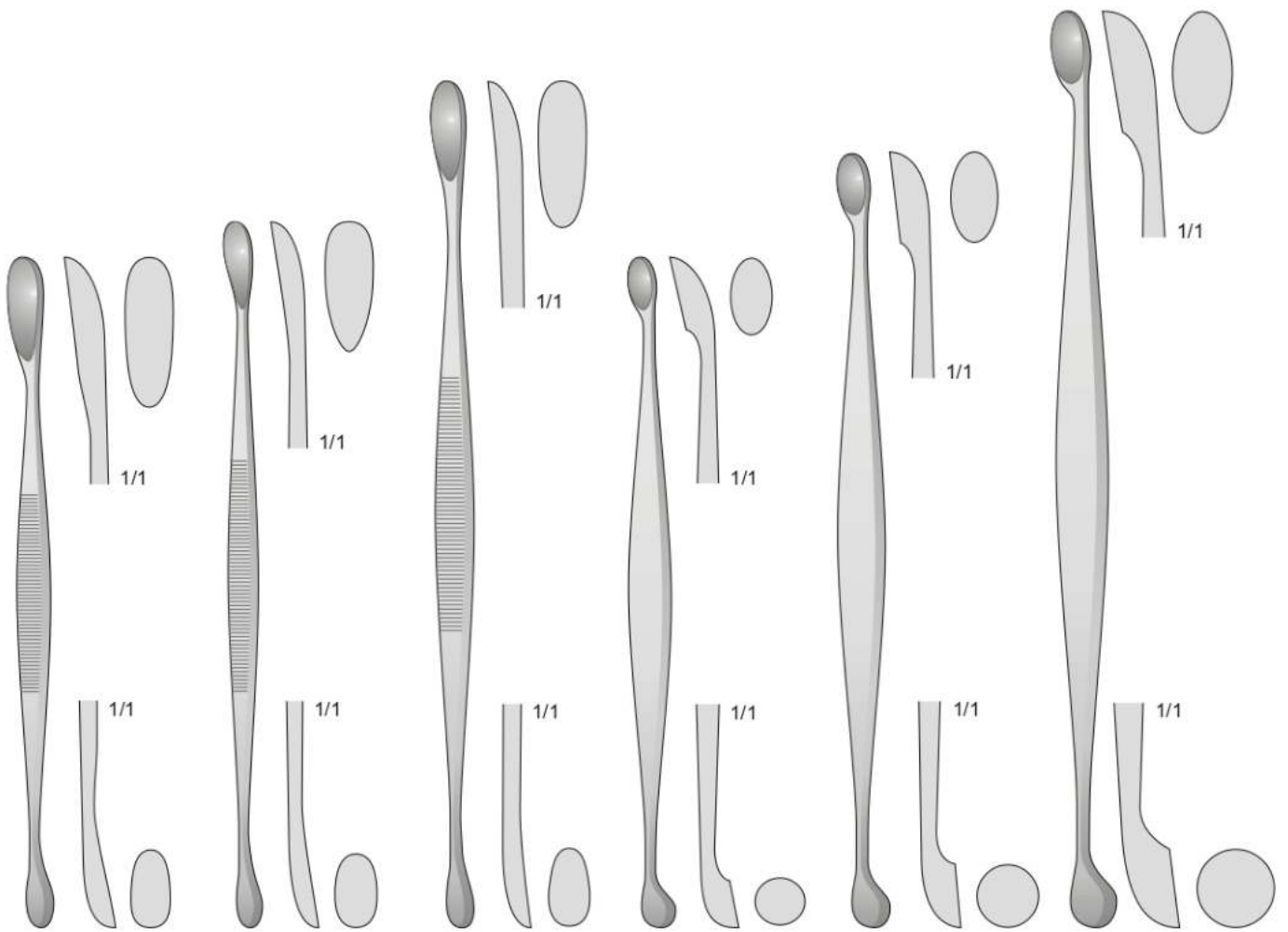
BARTH
ST-11635
180 mm



ST-11636
160 mm



JANSEN
ST-11637
160 mm



VOLKMANN
ST-11638
130 mm

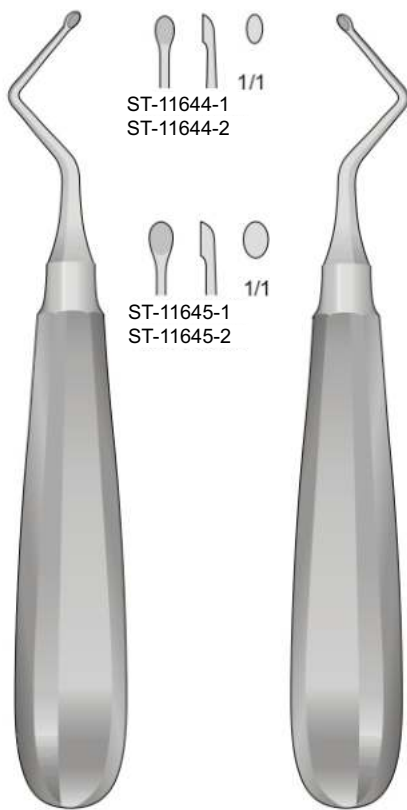
VOLKMANN
ST-11639
145 mm

VOLKMANN
ST-11640
170 mm

ST-11641
130 mm

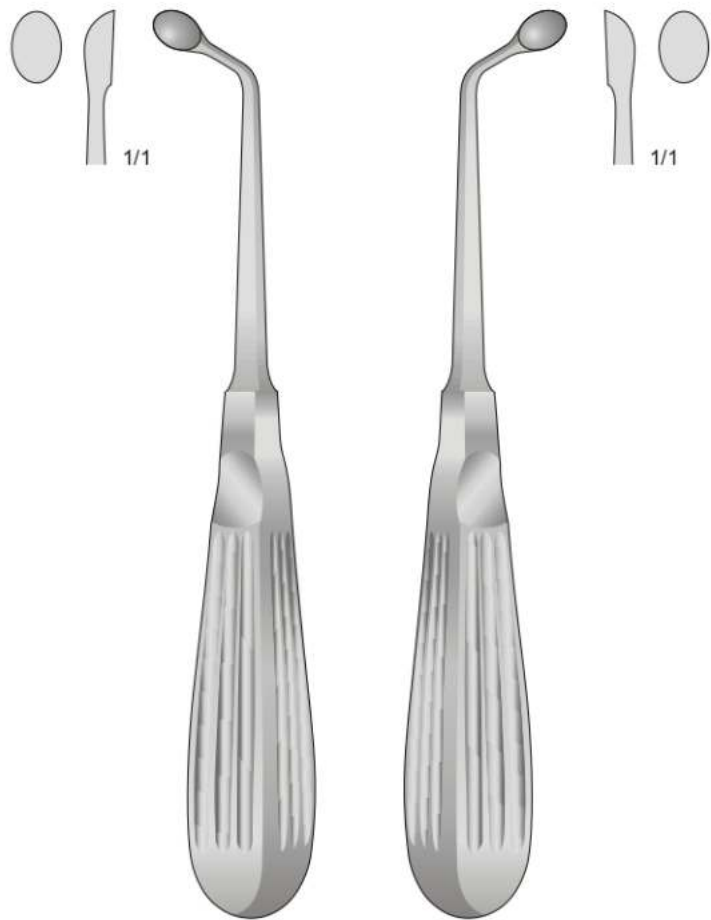
ST-11642
160 mm

ST-11643
200 mm



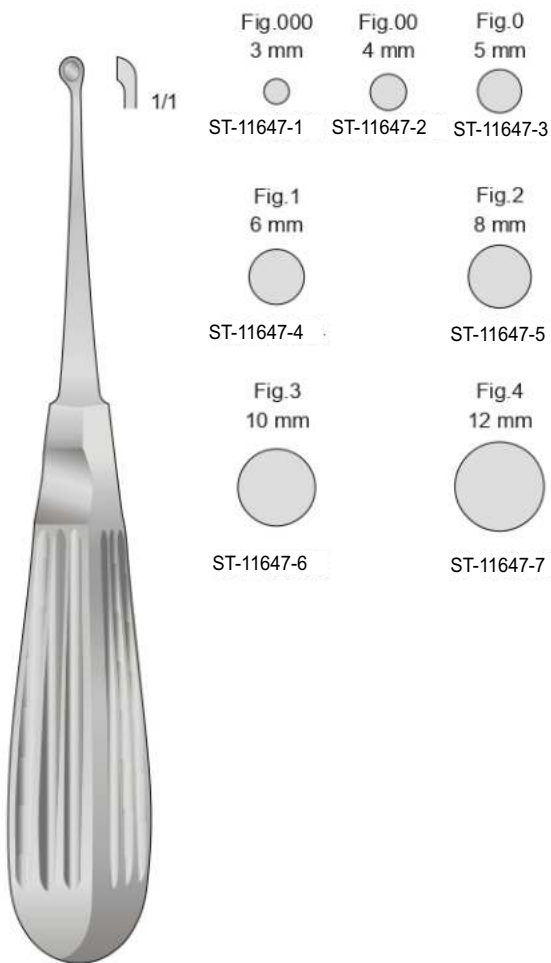
KERPEL
ST-11644-1
ST-11644-2
145 mm

KERPEL
ST-11645-1
ST-11645-2
145 mm

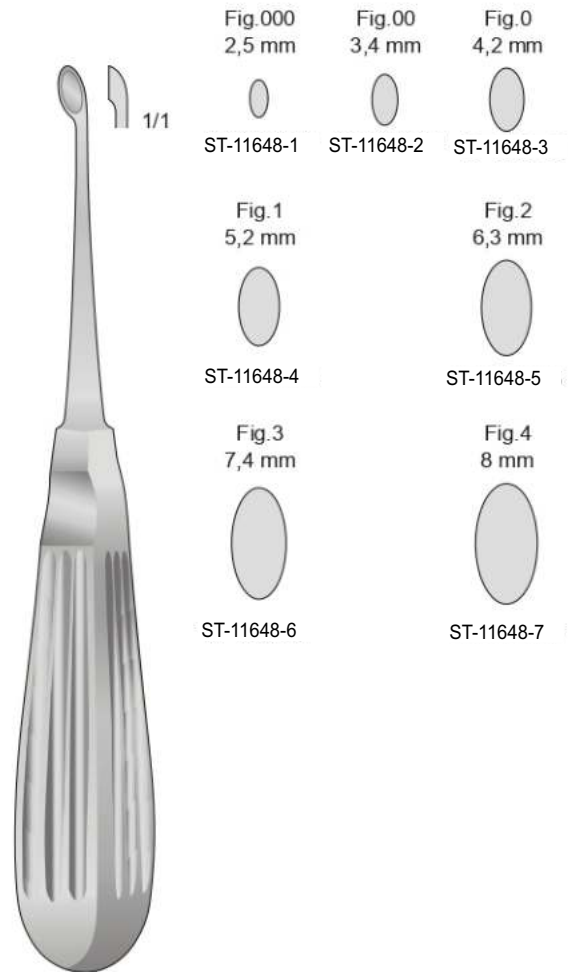


UFFENDORDE
ST-11646-1
170 mm

UFFENDORDE
ST-11646-2
170 mm



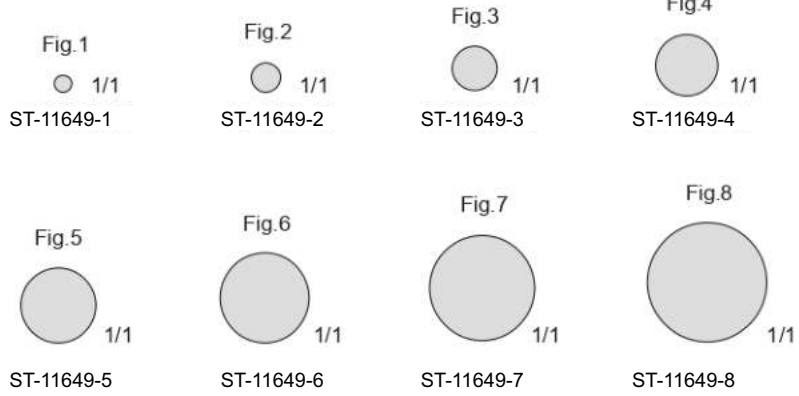
BRUNS
ST-11647
165 mm



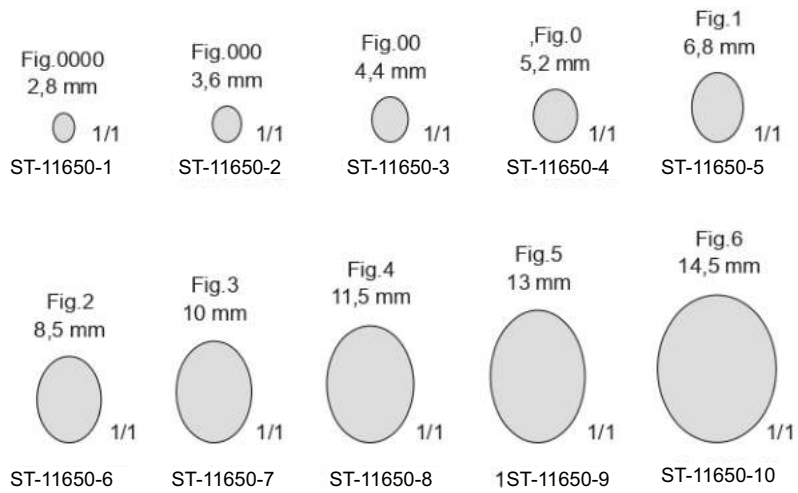
SCHEDE
ST-11648
170 mm

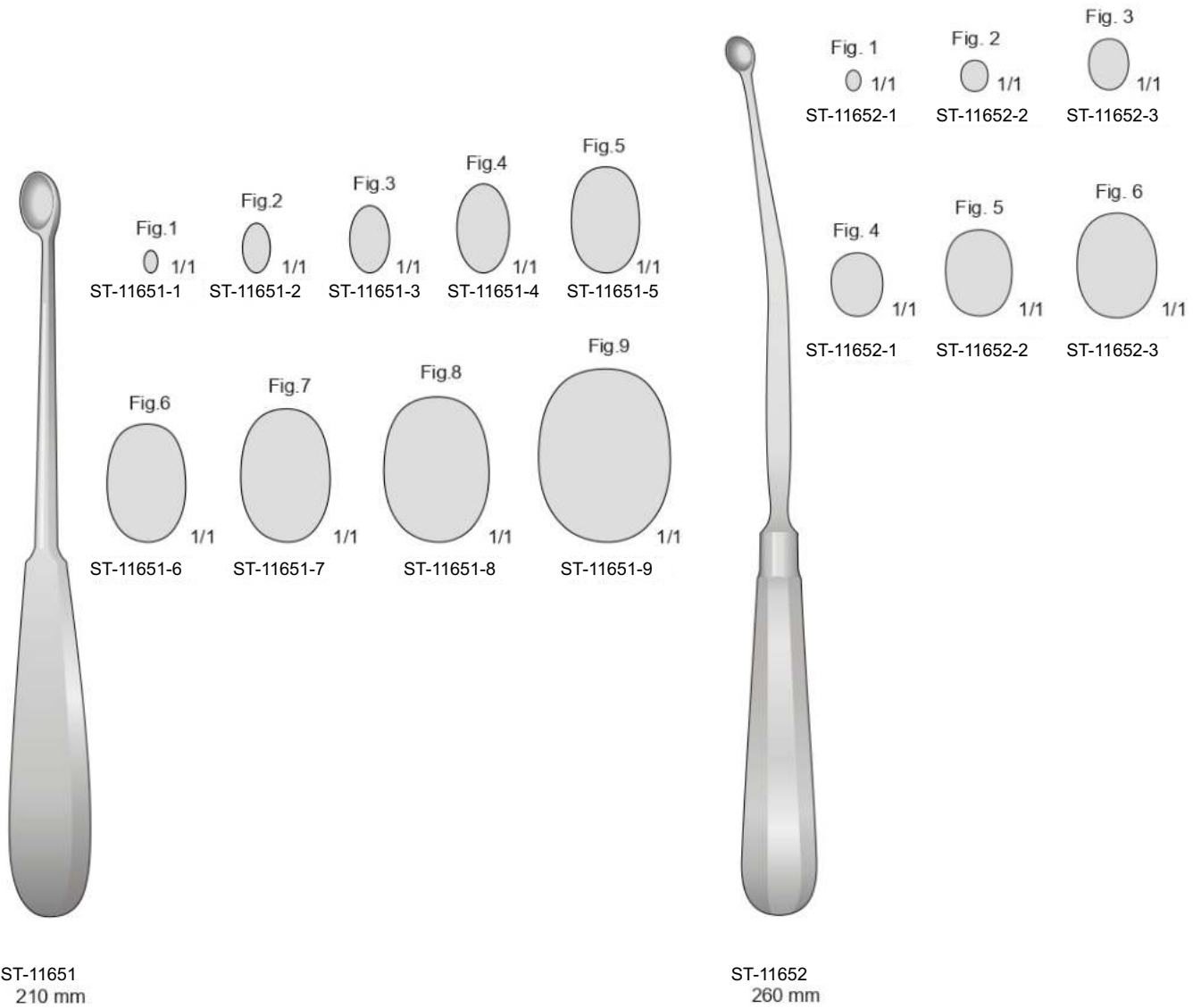


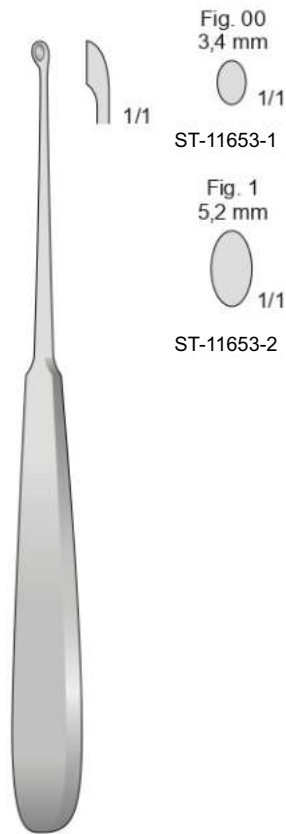
ST-11649
180 mm



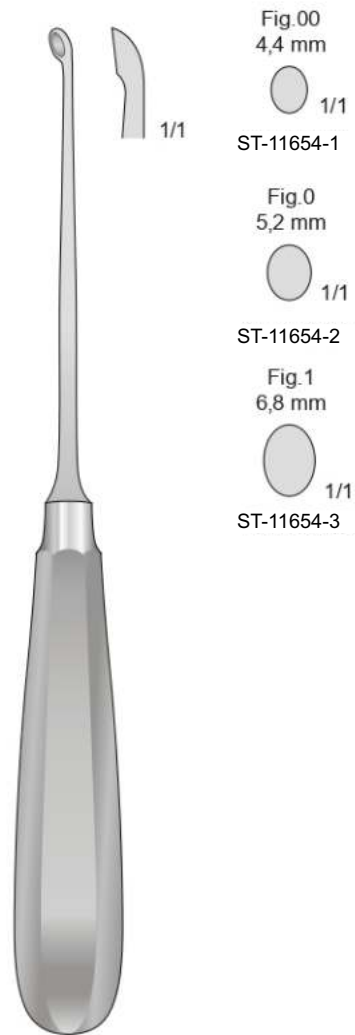
VOLKMANN
ST-11650
170 mm



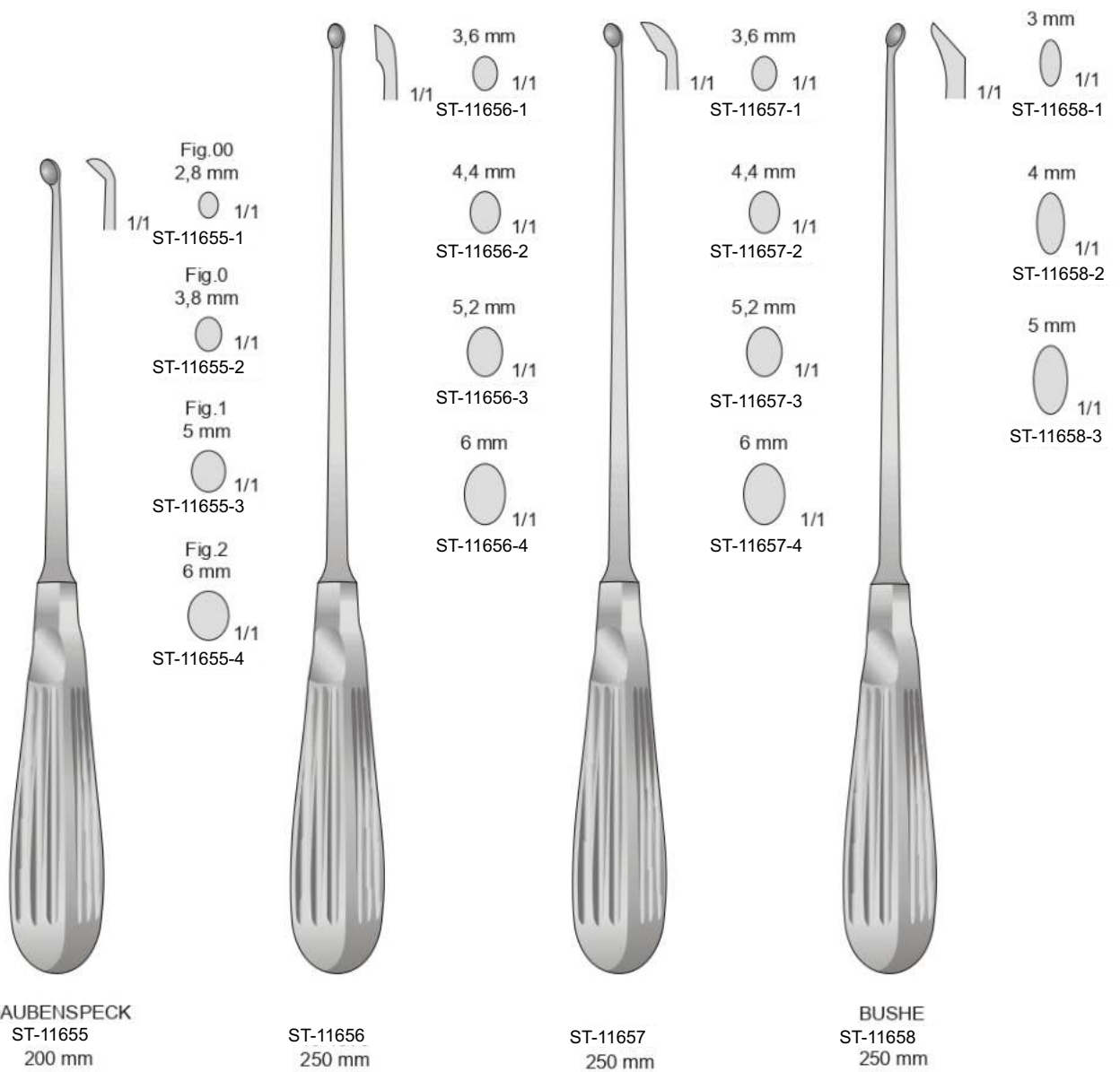


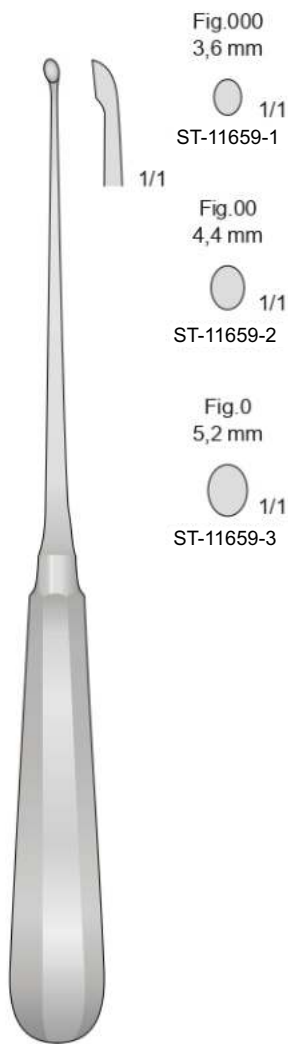


WILLIGER
ST-11653
170 mm

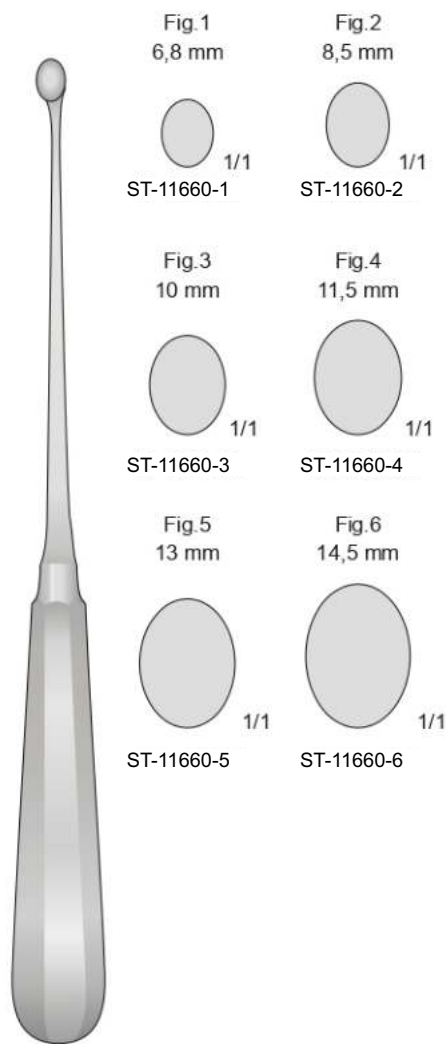


HALLE
ST-11654
215 mm

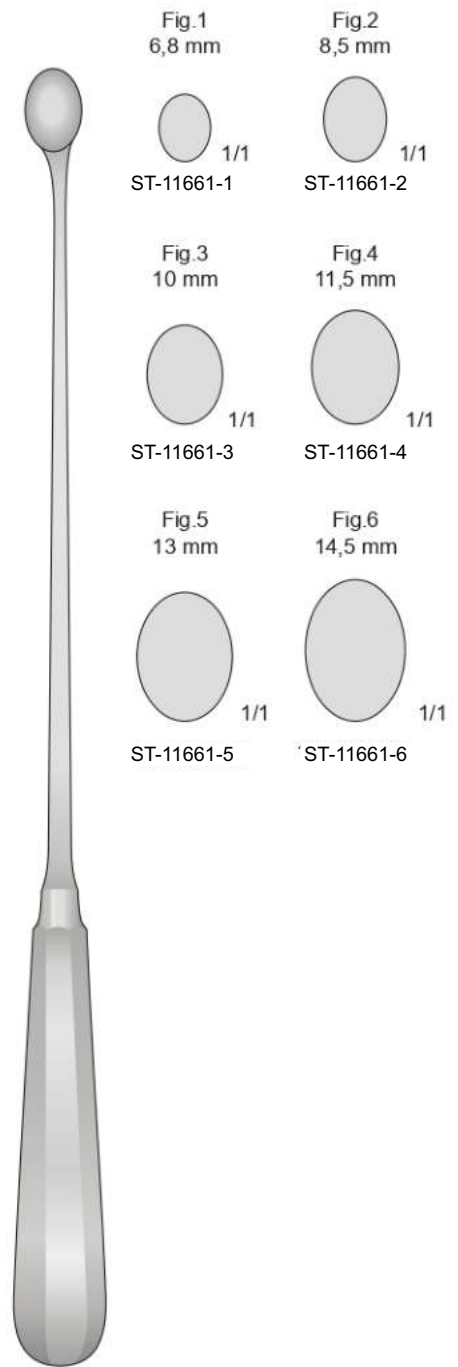




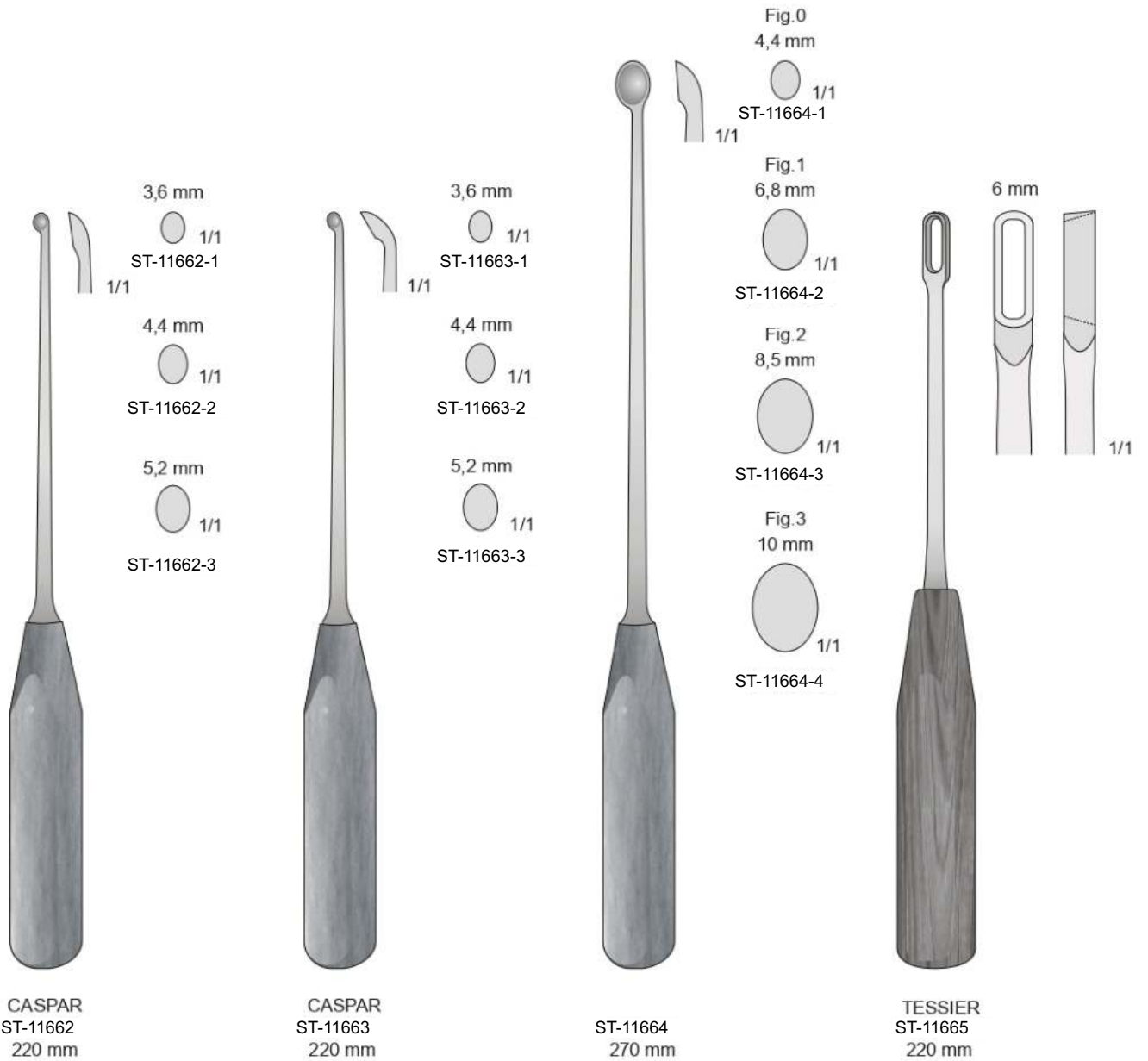
SIMON
ST-11659
235 mm



SIMON
ST-11660
240 mm

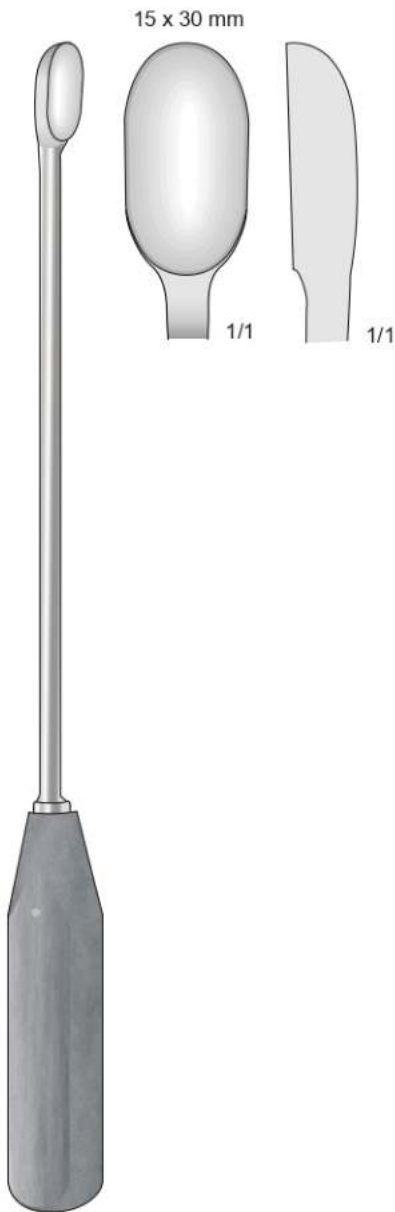


SCHRÖDER
ST-11661
310 mm

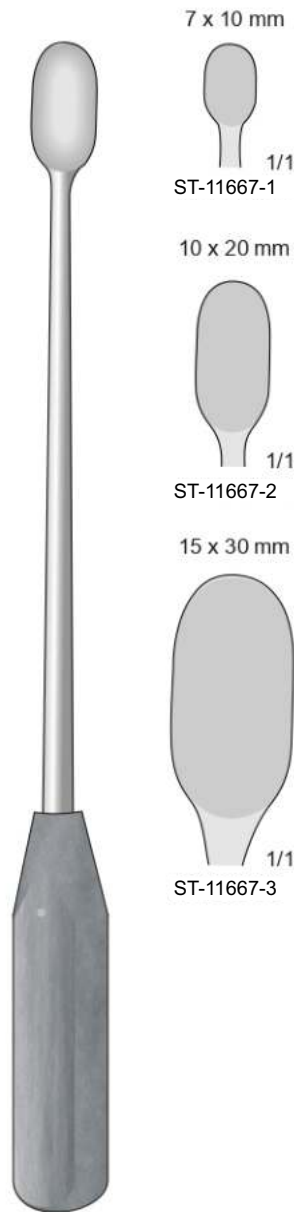


Strumentario per protesi femorale
Femoral prosthesis instrumentation
Instruments pour prothese femorale

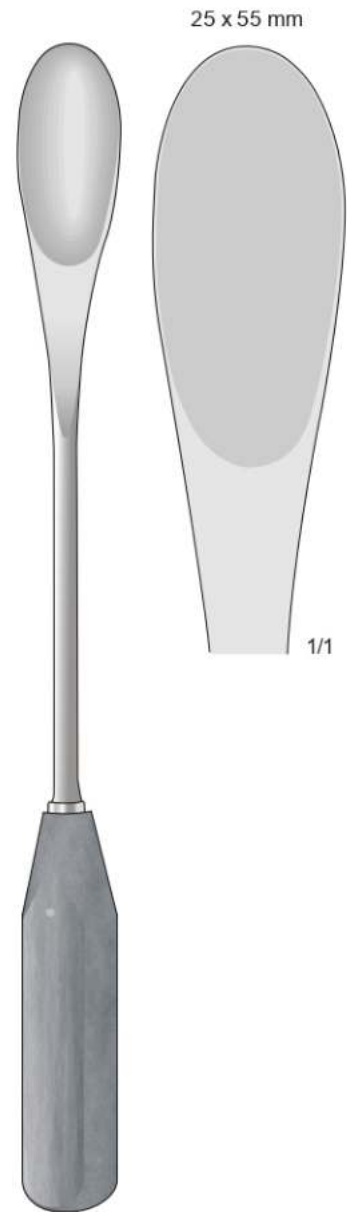
Con manico Ferrozell
With Ferrozell handle
Mit Ferrozellgriff
Avec poignée en Ferrozell
Con mango de Ferrozell



ST-11666
300 mm



ST-11667
300 mm

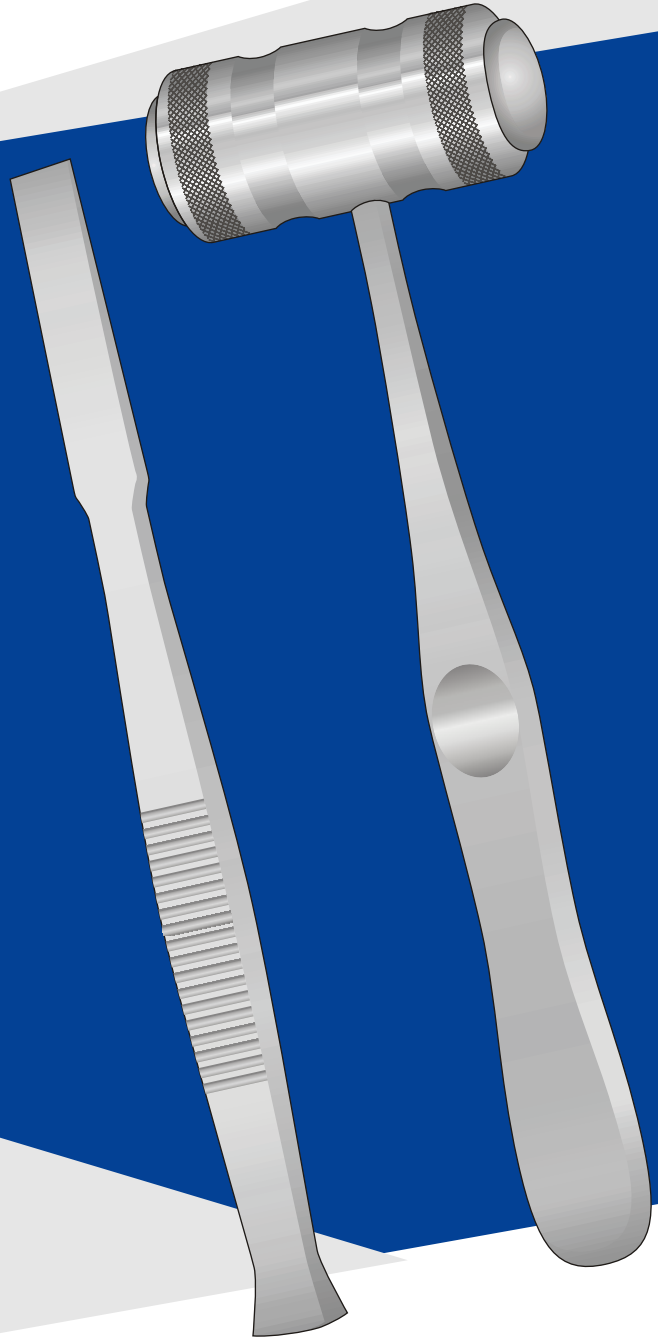


ST-11668
300 mm



SAFE TOOL
MANUFACTURER & EXPORTER

Mallet
Osteotome
Bone Chisel



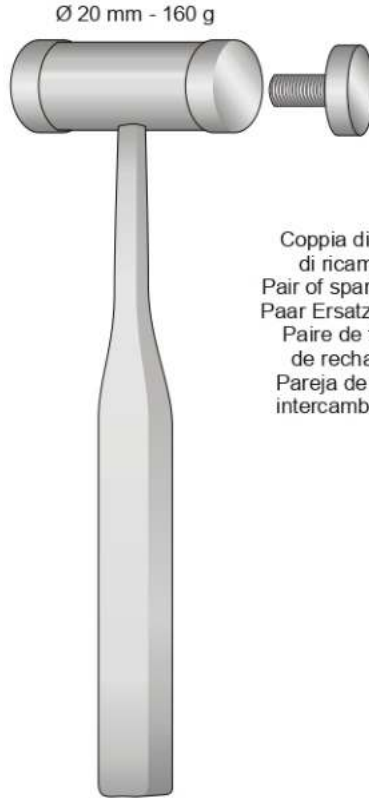
www.safetool.com.pk

Surgical
Instruments



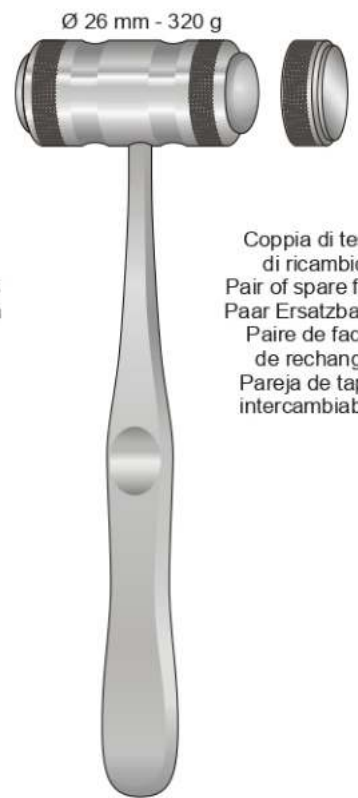
Coppia di teste di ricambio
Pair of spare faces
Paar Ersatzbacken
Paire de faces de rechange
Pareja de tapas intercambiables

MEAD
ST-8001
200 mm



Coppia di teste di ricambio
Pair of spare faces
Paar Ersatzbacken
Paire de faces de rechange
Pareja de tapas intercambiables

MEAD
ST-8002
190 mm

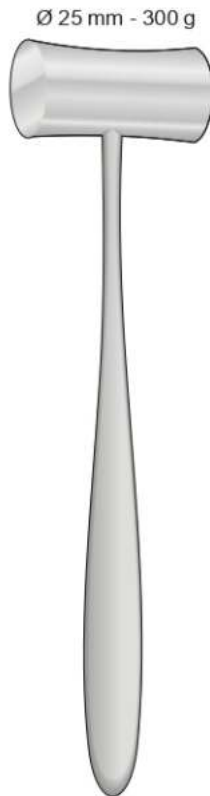


Coppia di teste di ricambio
Pair of spare faces
Paar Ersatzbacken
Paire de faces de rechange
Pareja de tapas intercambiables

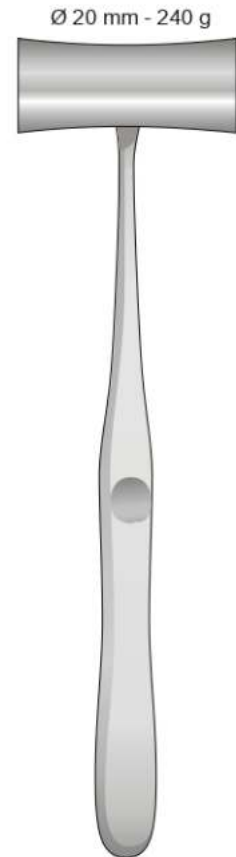
MEAD
ST-8003
190 mm



ST-8004
165 mm



LUCAE
ST-8005
190 mm



WILLIGER
ST-8006
240 mm



1 Lato piatto - 1 Lato convesso
1 Side flat - 1 Side convex
1 Seite flach - 1 Seite convex
1 Face plate - 1 Face convexe
1 Parte plana - 1 Parte convexa

Ø 30 mm - 240 g



COTTLE
ST-8007
185 mm

Ø 30 mm - 300 g



BERGMANN
ST-8008
235 mm

Ø 45 mm - 300 g



BERGMANN
ST-8009
245 mm



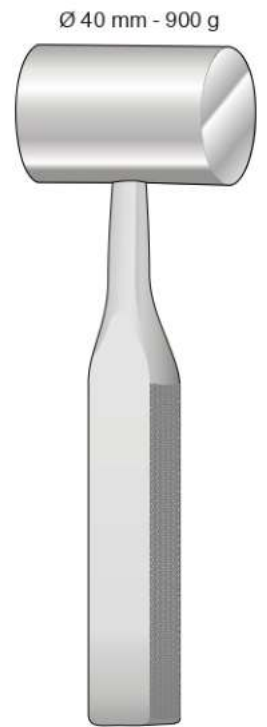
ST-8010
240 mm



OMBREDANNE
ST-8011
240 mm



HEAT
ST-8012
185 mm



ST-8013
190 mm



ST-8014
200 mm



ST-8015
260 mm



ST-8016
270 mm



- ST-8017-1
Ø3 mm
- ST-8017-2
Ø5 mm
- ST-8017-3
Ø8 mm

CASPAR
ST-8017
200 mm



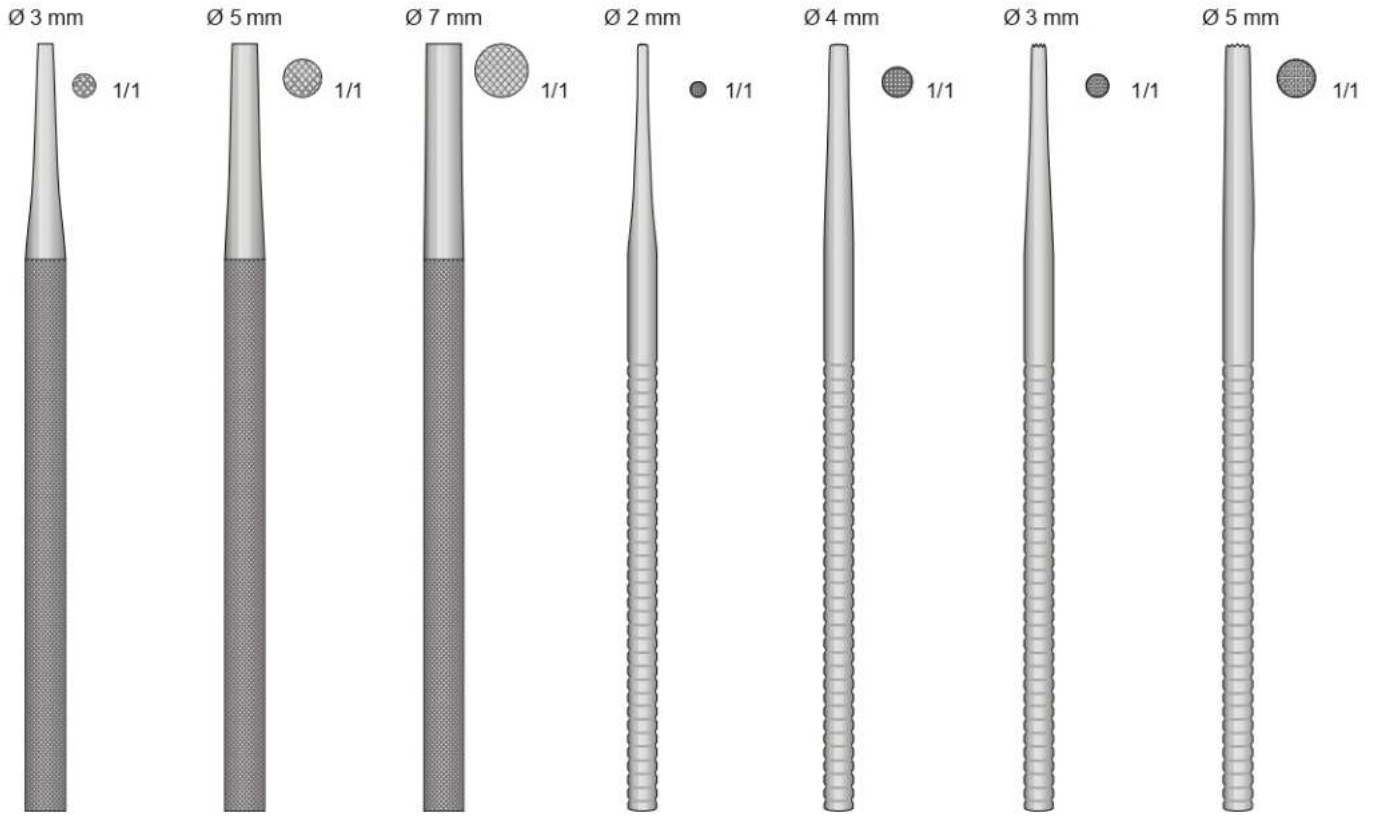
- ST-8018-1
Ø12 mm
- ST-8018-2
Ø14 mm
- ST-8018-3
Ø16 mm

ST-8018
200 mm

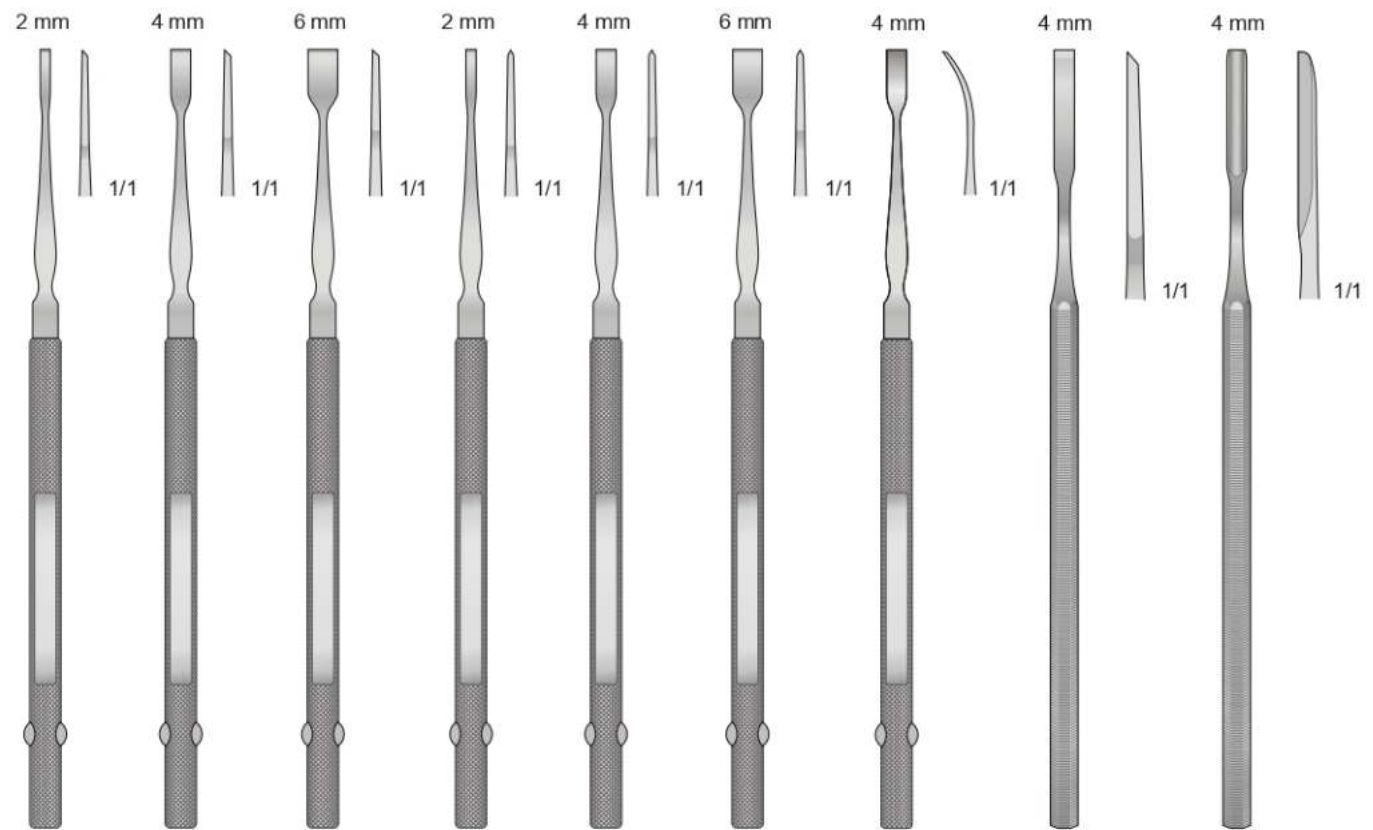


- ST-8019-1
3x8 mm
- ST-8019-2
4x10 mm
- ST-8019-3
5x15 mm
- ST-8019-4
6x20 mm

SYPERT
ST-8019
290 mm



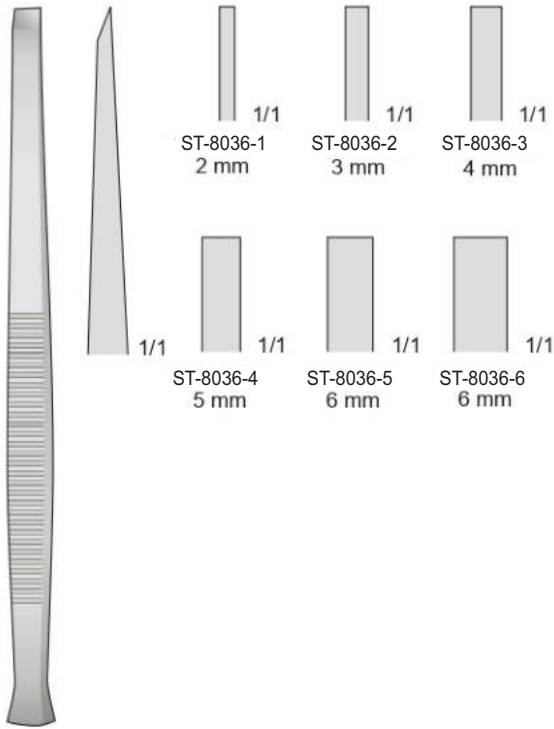
ST-8020 155 mm ST-8021 155 mm ST-8022 155 mm ST-8023 155 mm ST-8024 155 mm ST-8025 155 mm ST-8026 155 mm



ST-8027 160 mm ST-8028 160 mm ST-8029 160 mm ST-8030 160 mm ST-8031 160 mm ST-8032 160 mm FREER ST-8033 160 mm BUCKLEY ST-8034 160 mm BUCKLEY ST-8035 160 mm

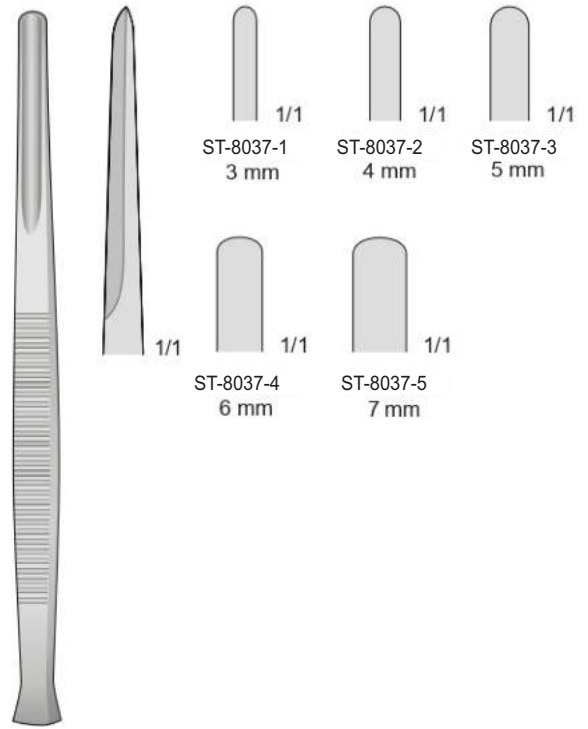


Osteotomi - Osteotomes
Osteotome - Ostéotomes - Osteótomos



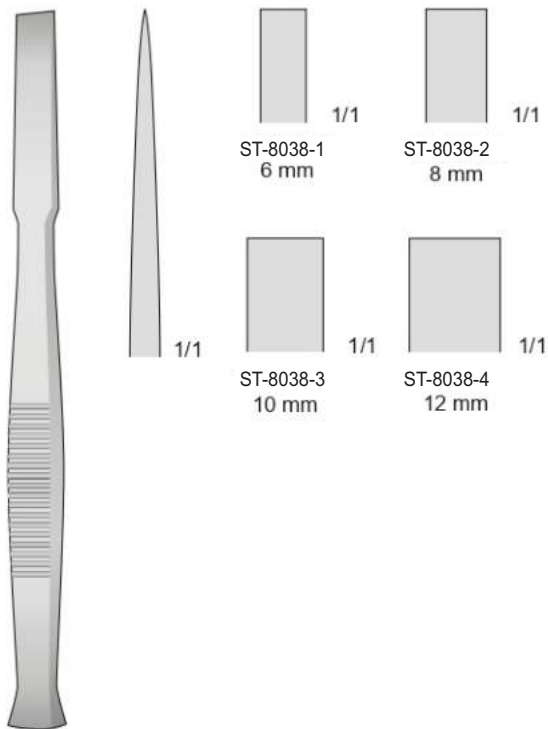
PARTSCH
ST-8036
140 mm

Sgorbie - Gouges
Hohlmeissel - Gouges - Gubias



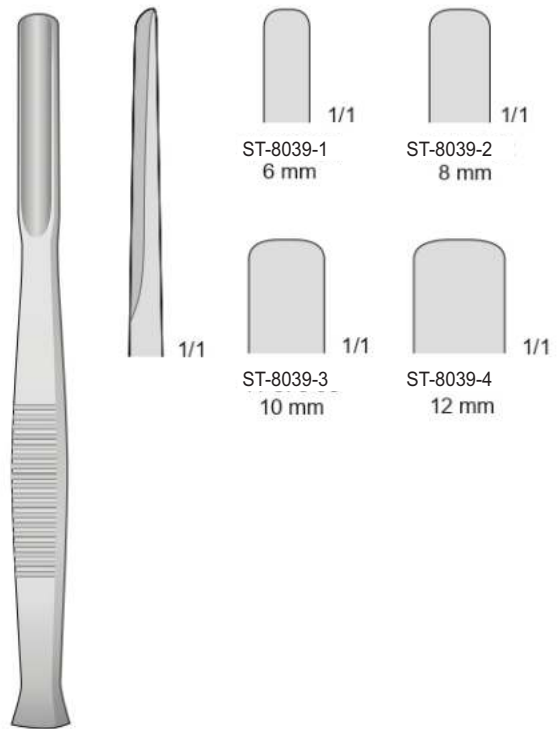
PARTSCH
ST-8037
140 mm

Osteotomi - Osteotomes
Osteotome - Ostéotomes - Osteótomos

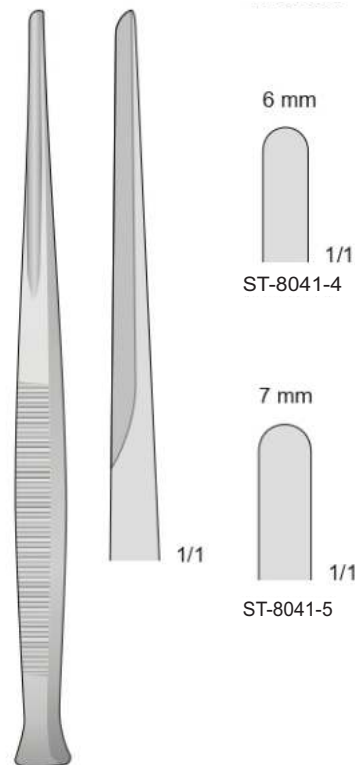
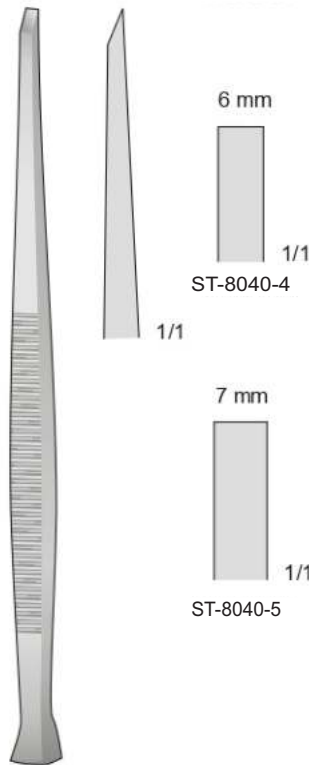
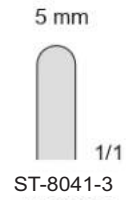
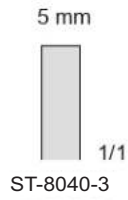
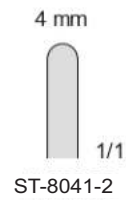
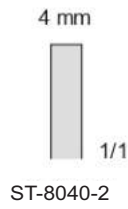
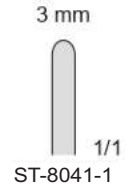
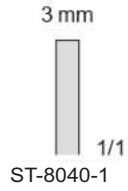


ST-8038
140 mm

Sgorbie - Gouges
Hohlmeissel - Gouges - Gubias

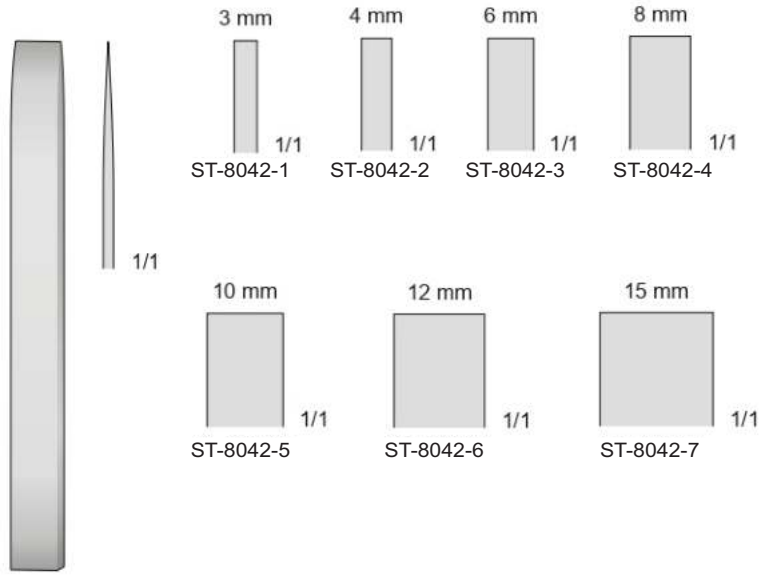


ST-8039
140 mm



PARTSCH
ST-8040
170 mm

PARTSCH
ST-8041
170 mm



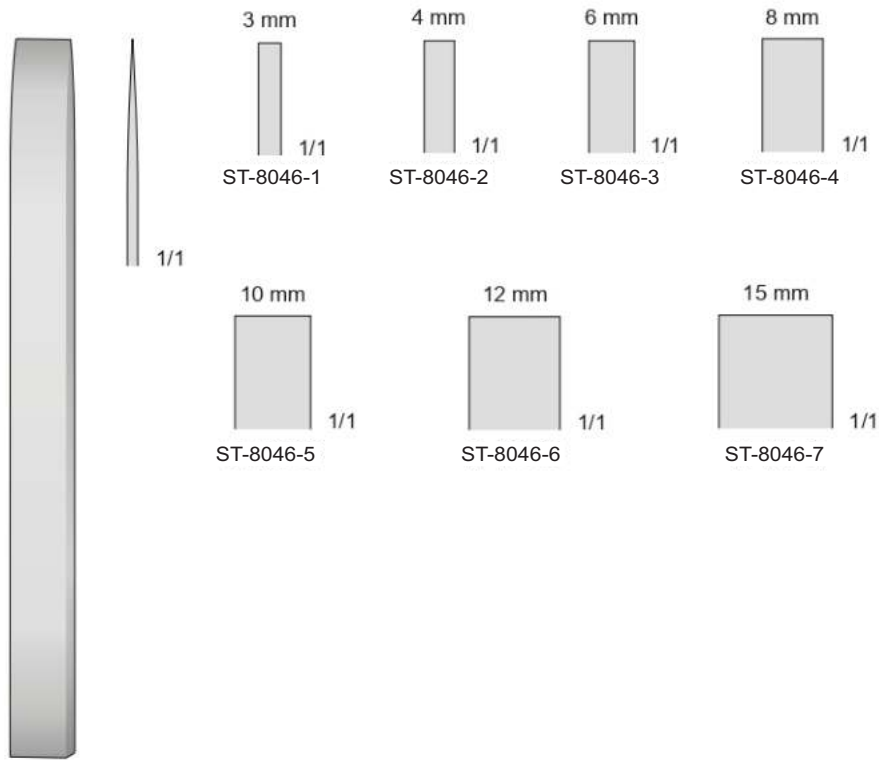
MINI-LAMBOTTE
ST-8042
125 mm



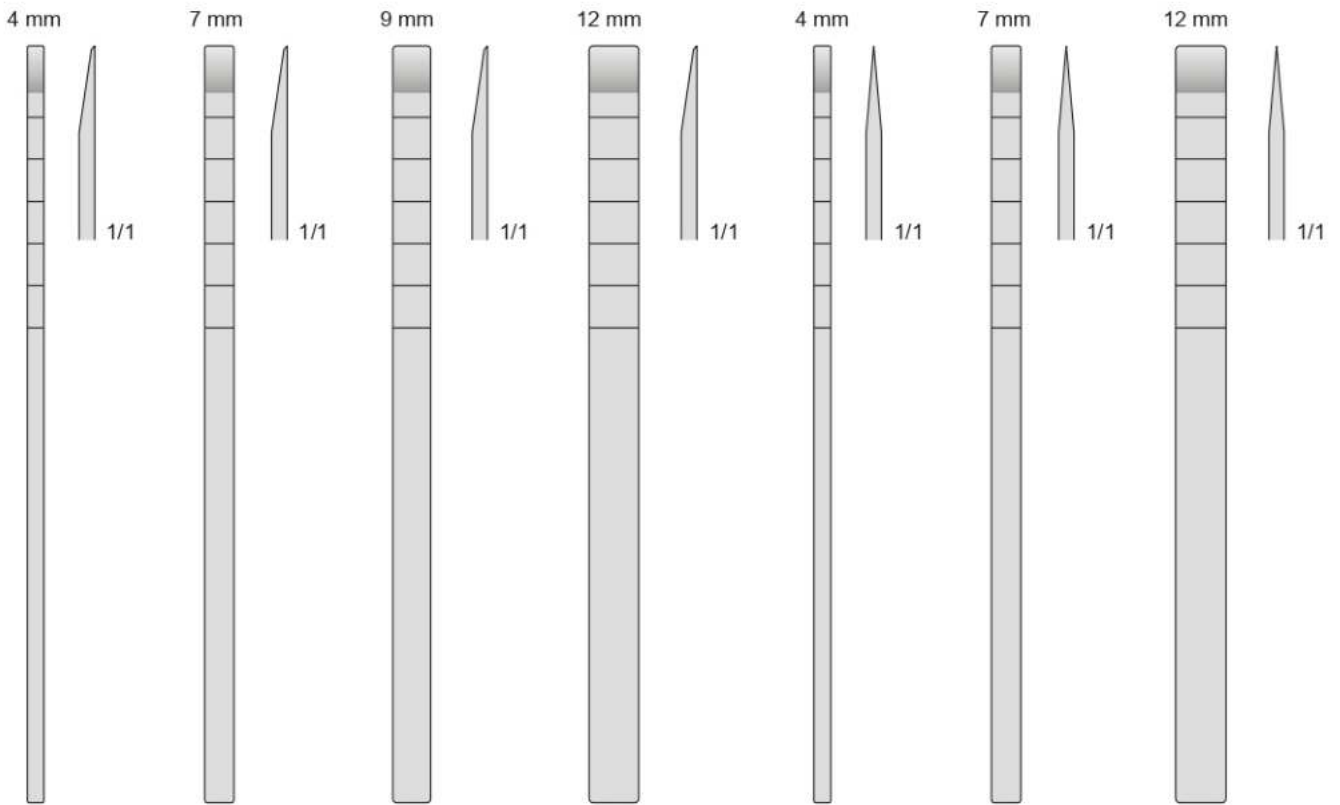
LAMBOTTE
ST-8043
250 mm

LAMBOTTE
ST-8044
250 mm

OBWEGESER
ST-8045
235 mm



MINI-LAMBOTTE
ST-8046
170 mm



COTTLE
ST-8047-1
180 mm

COTTLE
ST-8047-2
180 mm

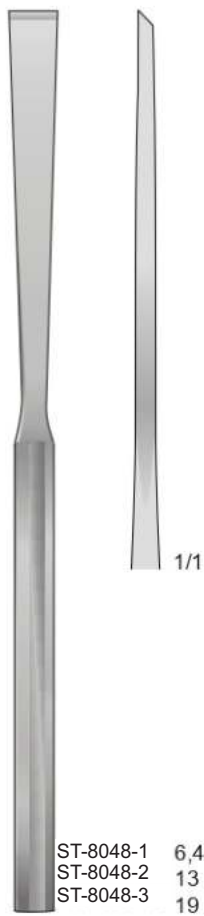
COTTLE
ST-8047-3
180 mm

COTTLE
ST-8047-4
180 mm

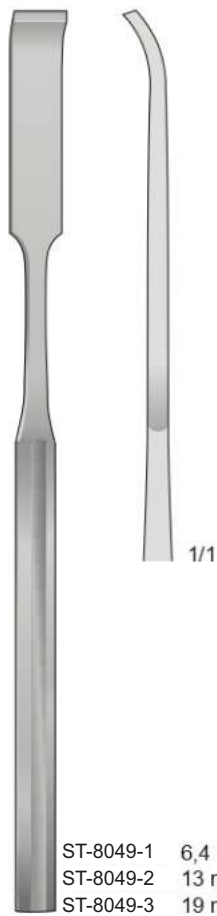
COTTLE
ST-8047-5
180 mm

COTTLE
ST-8047-6
180 mm

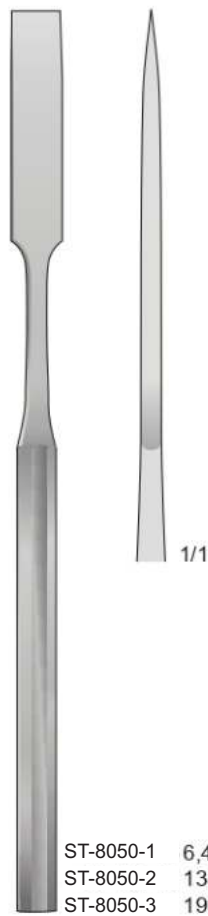
COTTLE
ST-8047-7
180 mm



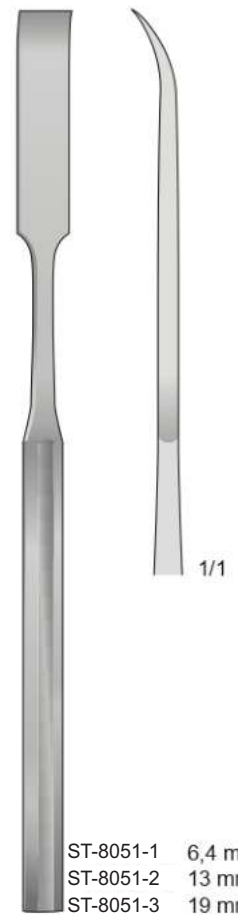
HIBBS
ST-8048
230 mm



HIBBS
ST-8049
230 mm



HIBBS
ST-8050
230 mm



HIBBS
ST-8051
230 mm



ST-8052-1 4 mm
ST-8052-2 6 mm
ST-8052-3 8 mm

ST-8052
180 mm



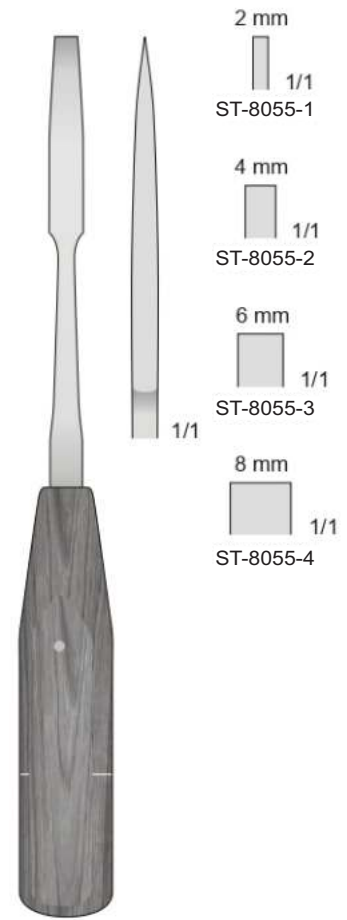
ST-8053-1 4 mm
ST-8053-2 6 mm
ST-8053-3 8 mm

ST-8053
180 mm



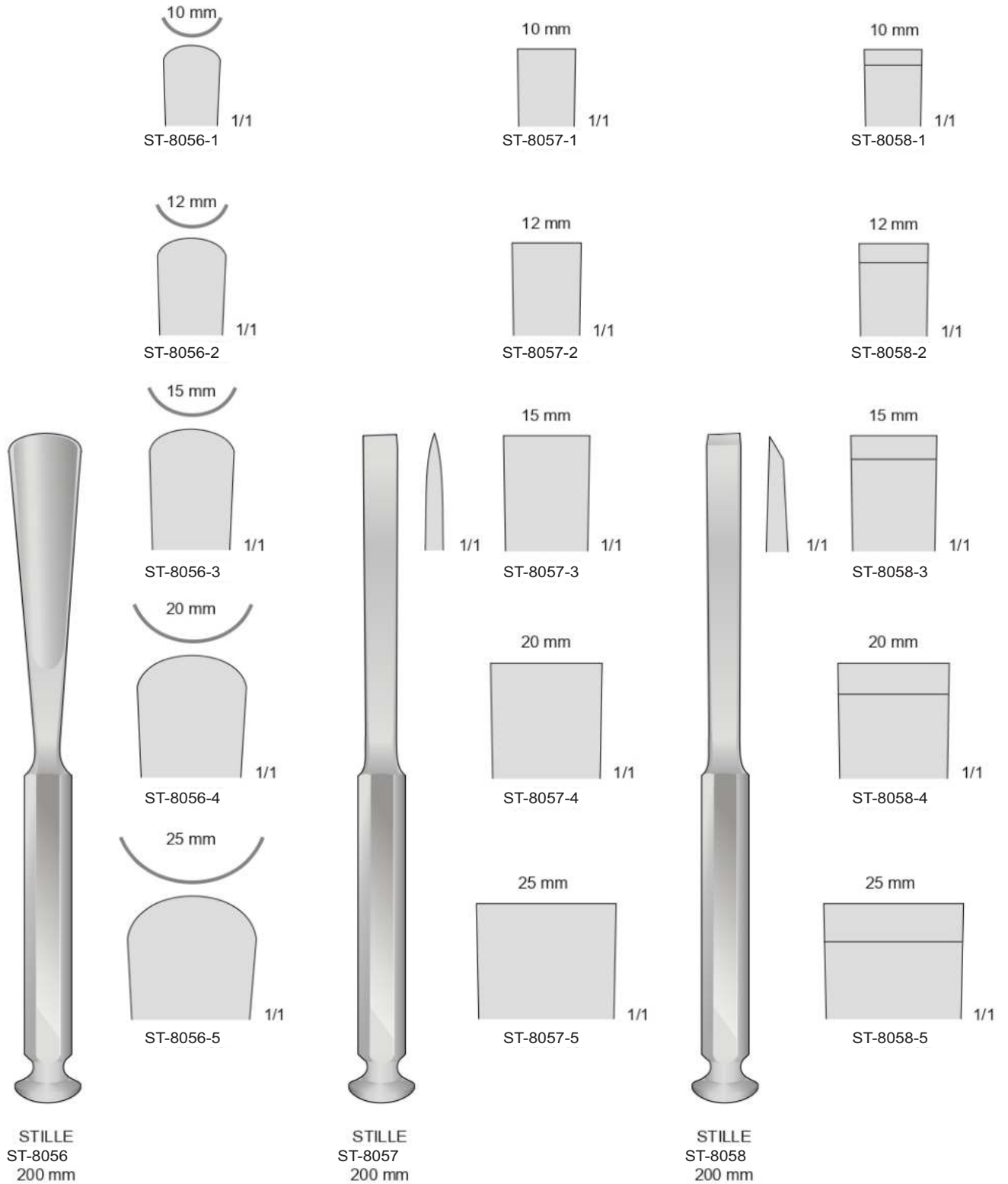
ST-8054-1 6 mm
ST-8054-1 8 mm

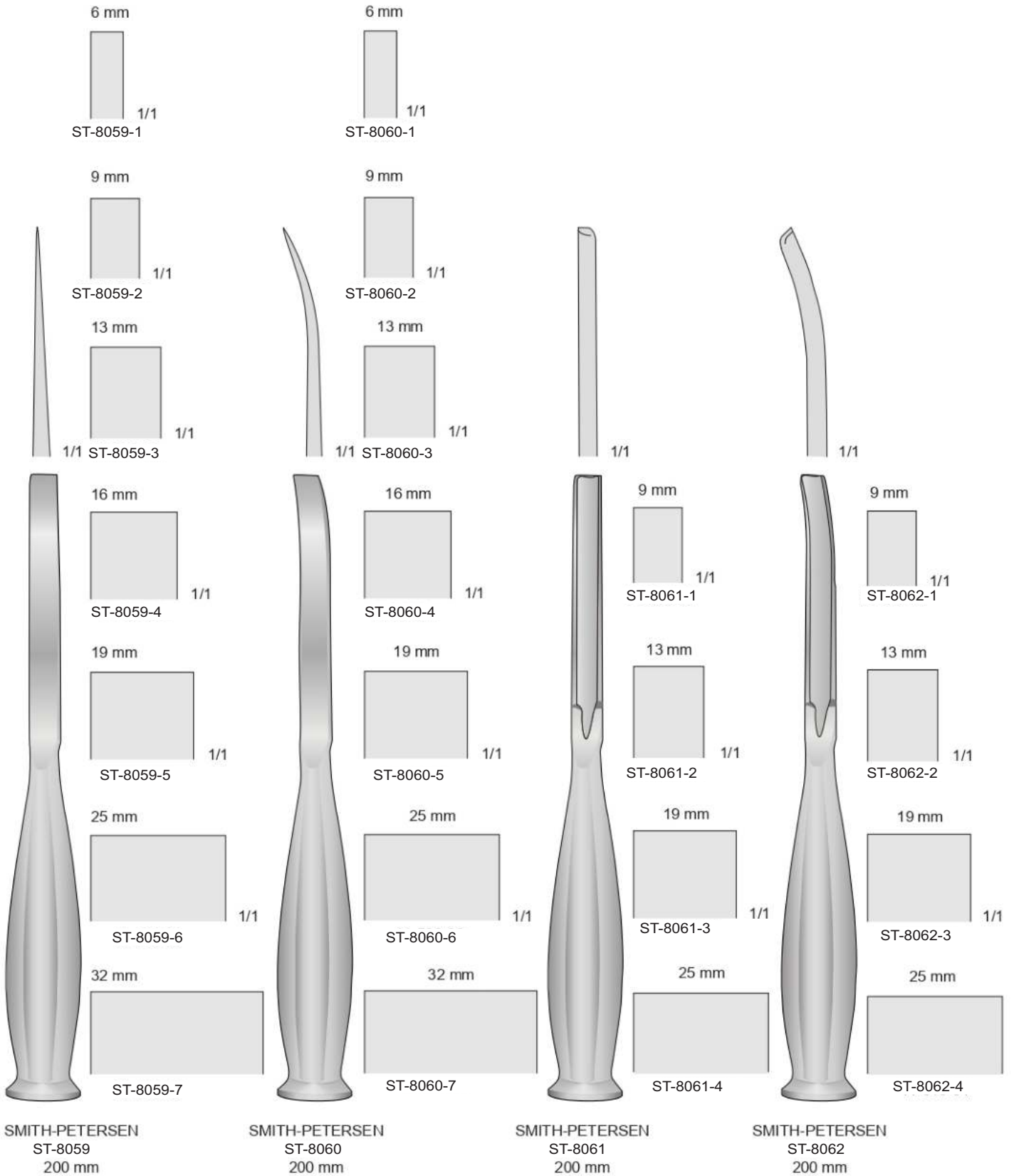
ST-8054
180 mm

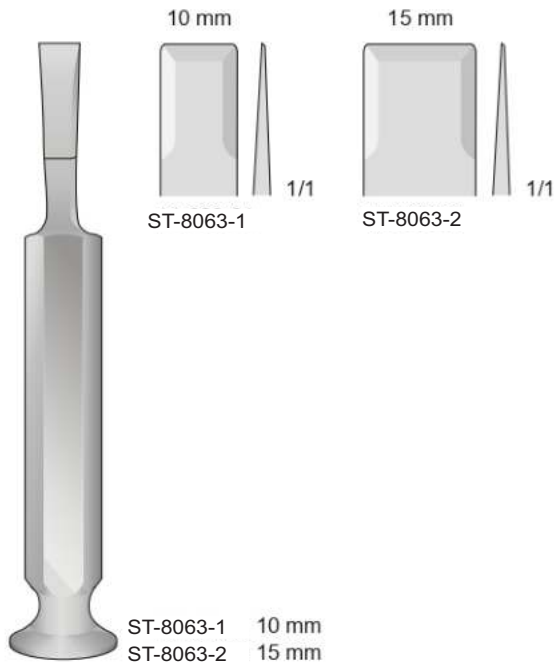


2 mm 1/1
ST-8055-1
4 mm 1/1
ST-8055-2
6 mm 1/1
ST-8055-3
8 mm 1/1
ST-8055-4

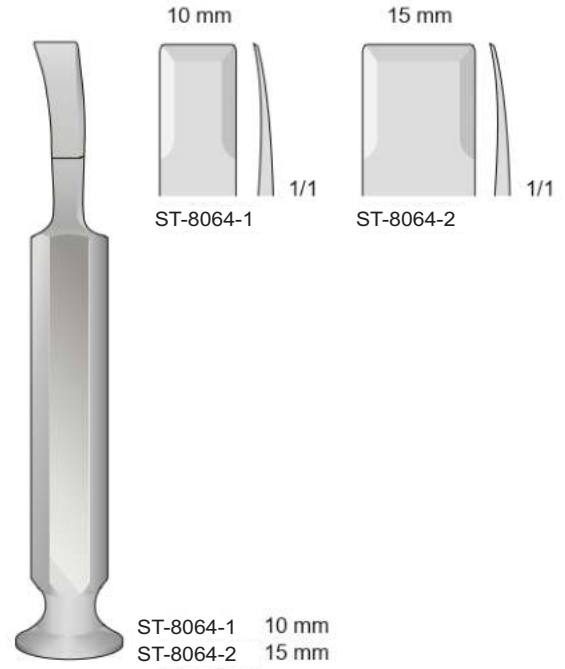
MINI-LEXER
ST-8055
200 mm



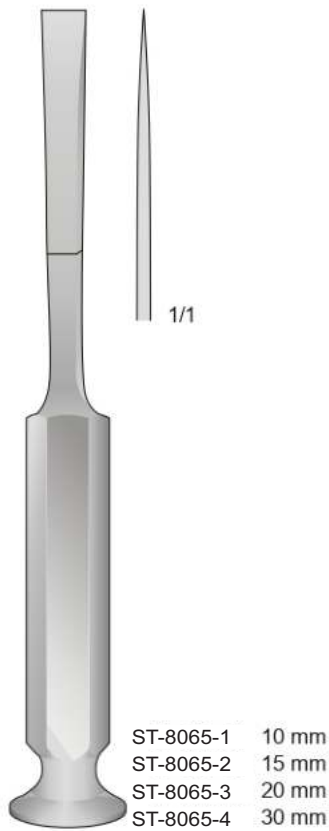




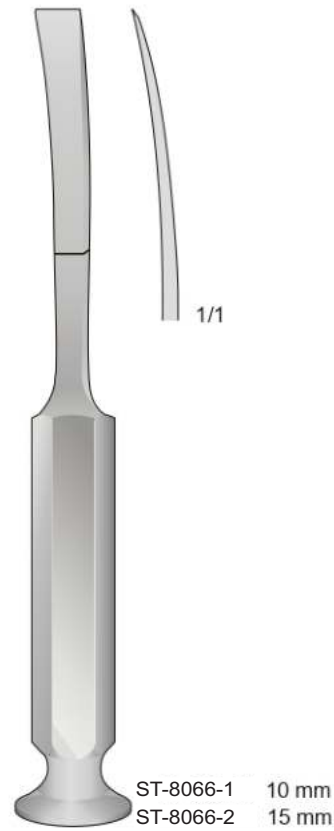
TESSIER
ST-8063
160 mm



TESSIER
ST-8064
160 mm



TESSIER
ST-8065
200 mm

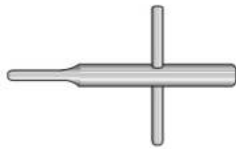


TESSIER
ST-8066
200 mm

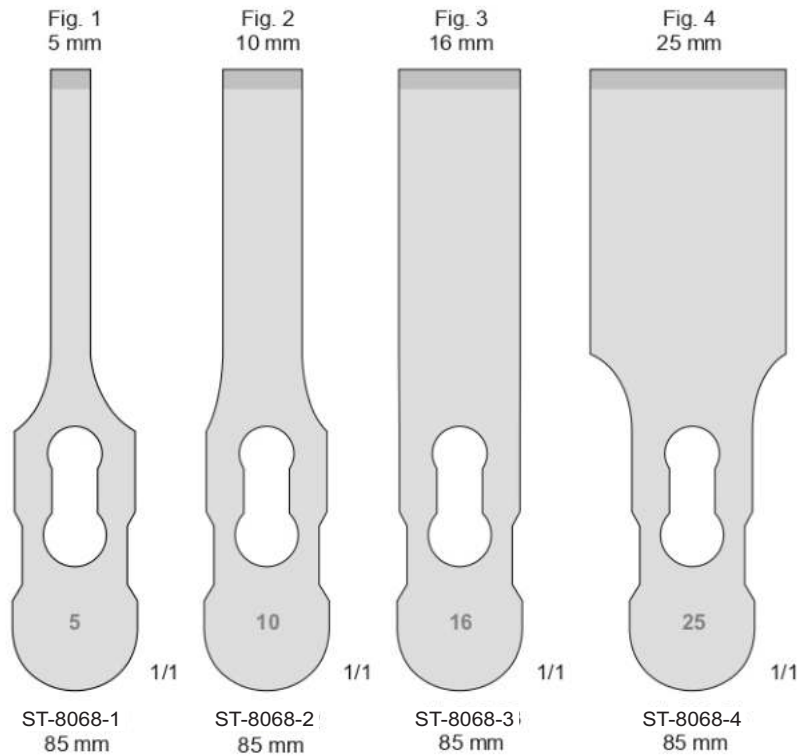
Set completo di Set complete with Komplettsset mit Set complet avec Set completo con		
1 Manico portalamo in ferrozell	4 Lame Fig. 1-2-3-4	1 Chiave ferma lama
1 With Ferrozell handle	4 Blades Fig. 1-2-3-4	-
1 Mit Ferrozellgriff	4 Klingen Fig. 1-2-3-4	-
1 Avec poignée en Ferrozell	4 Lames Fig. 1-2-3-4	-
1 Con mango de Ferrozell	4 Hojas Fig. 1-2-3-4	-



ST-8067
190 mm



ST-8068
90 mm





- ST-8069-1 4 mm
- ST-8069-2 6 mm
- ST-8069-3 8 mm
- ST-8069-4 10 mm
- ST-8069-5 12 mm

MINI-LEXER
ST-8069
180 mm



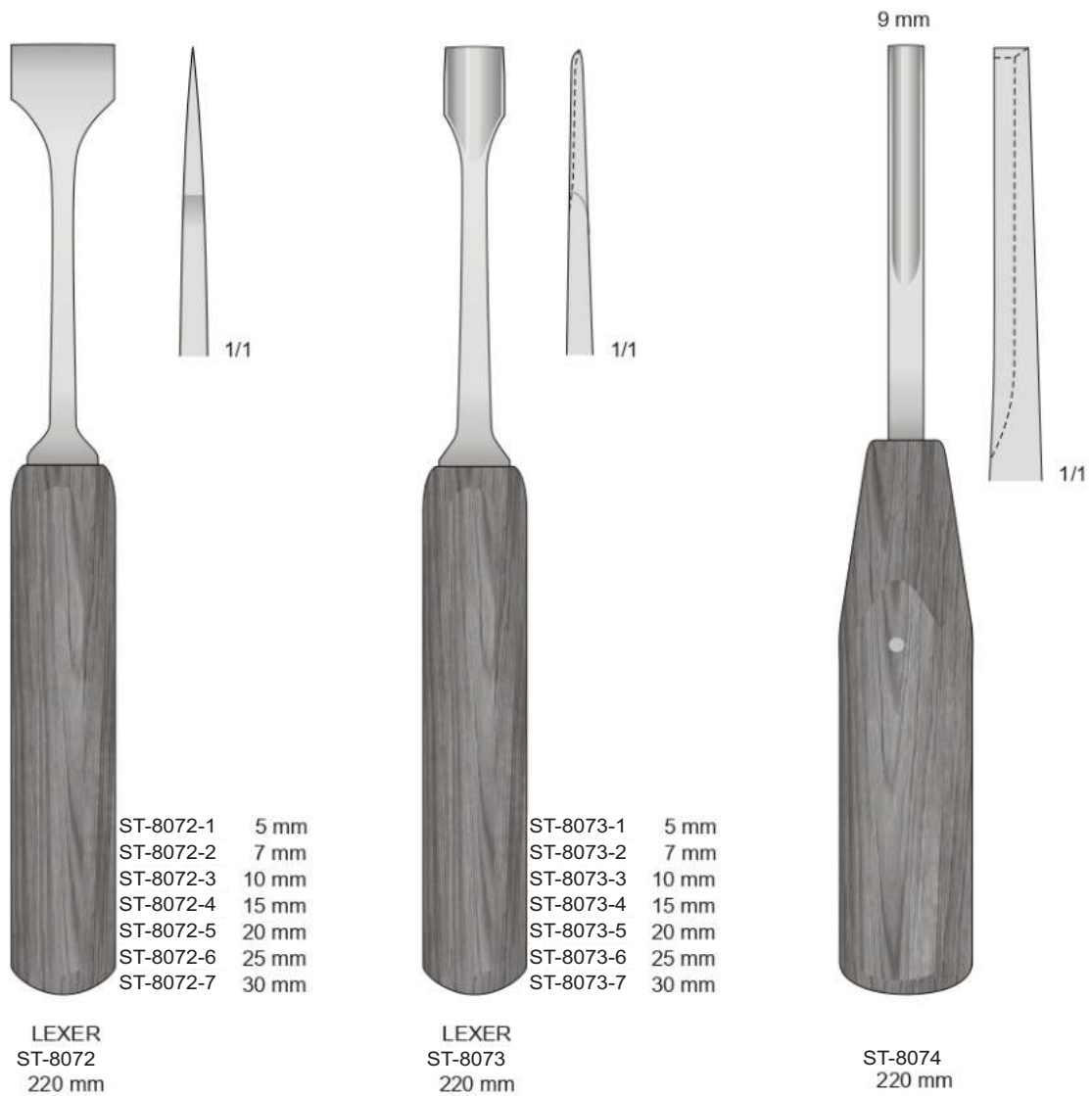
- ST-8070-1 4 mm
- ST-8070-2 6 mm
- ST-8070-3 8 mm
- ST-8070-4 10 mm
- ST-8070-5 12 mm

MINI-LEXER
ST-8070
180 mm



- ST-8071-1 4 mm
- ST-8071-2 6 mm
- ST-8071-3 8 mm
- ST-8071-4 10 mm
- ST-8071-5 12 mm

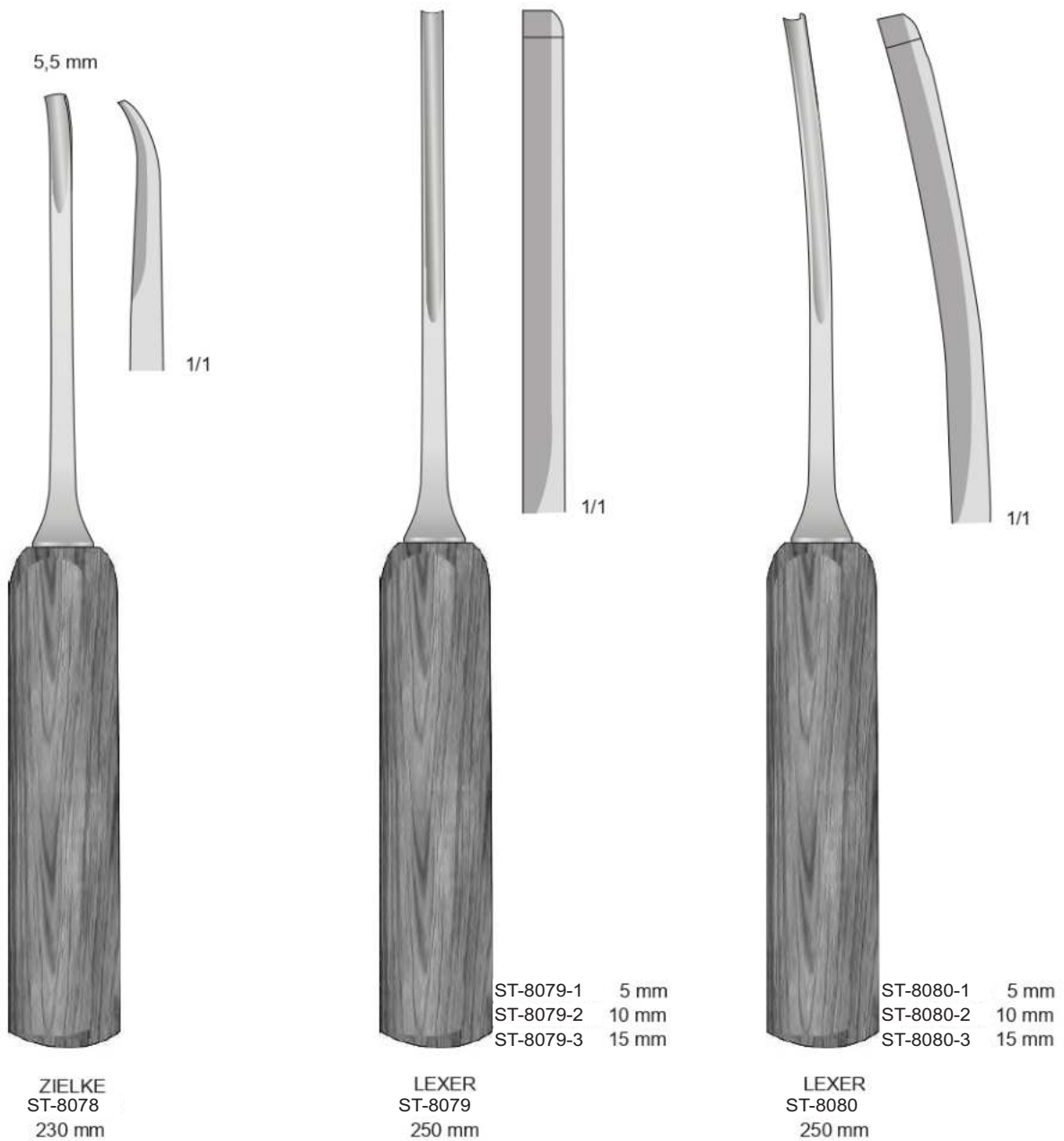
LEXER
ST-8071
180 mm

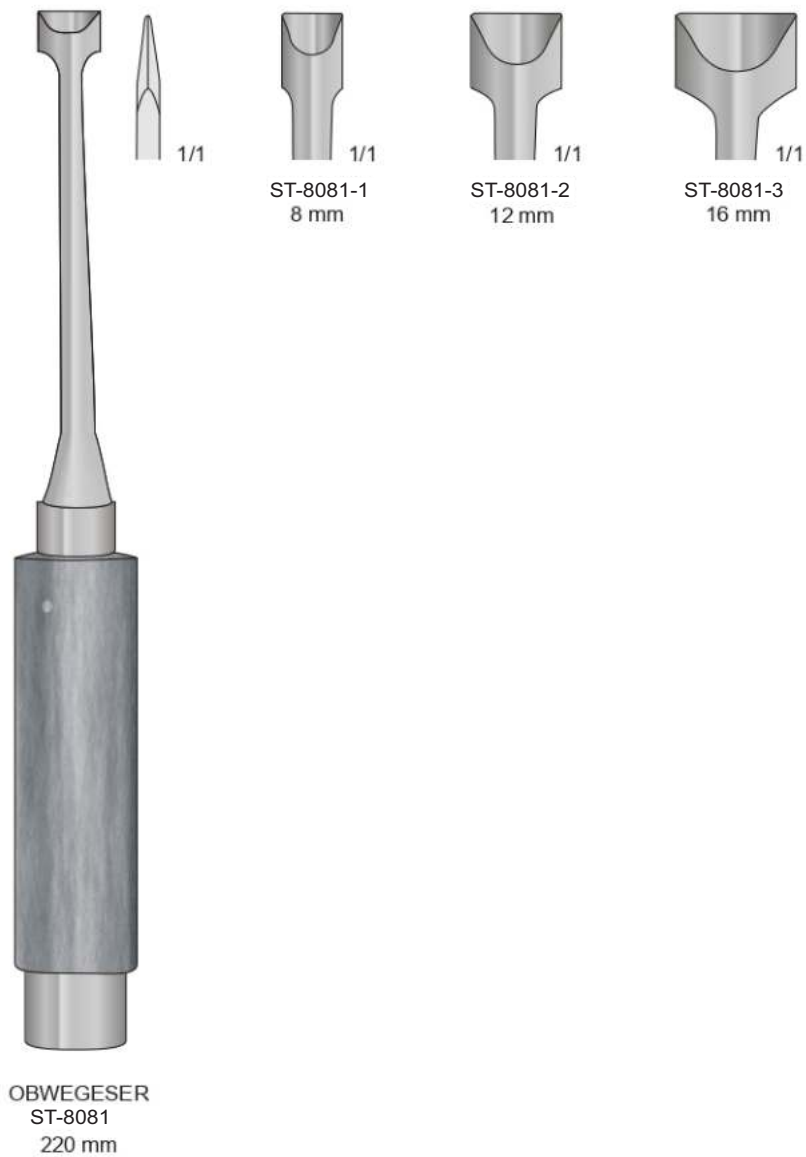


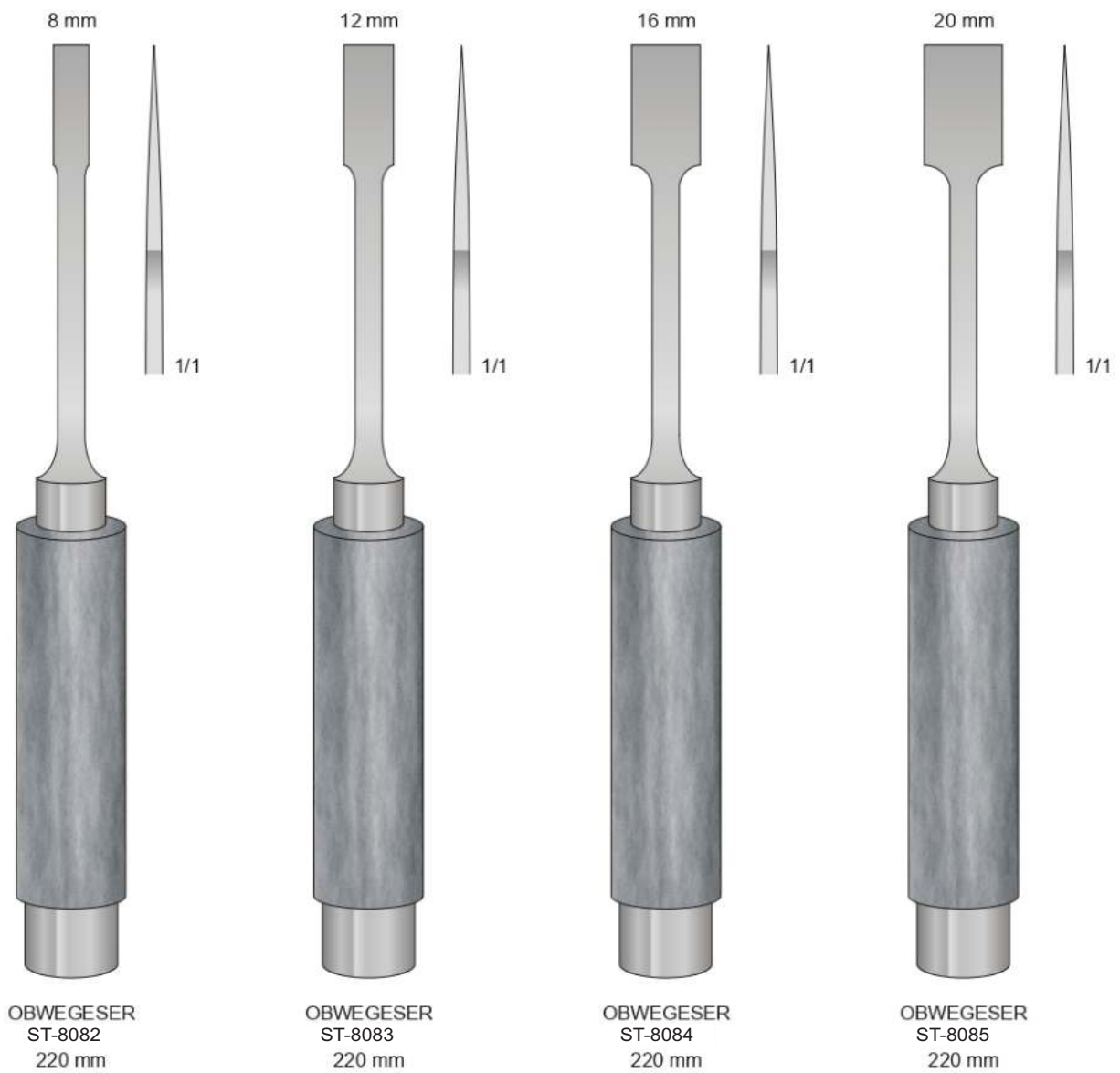




Sgorbie - Gouges
Hohlmeissel - Gouges - Gubias

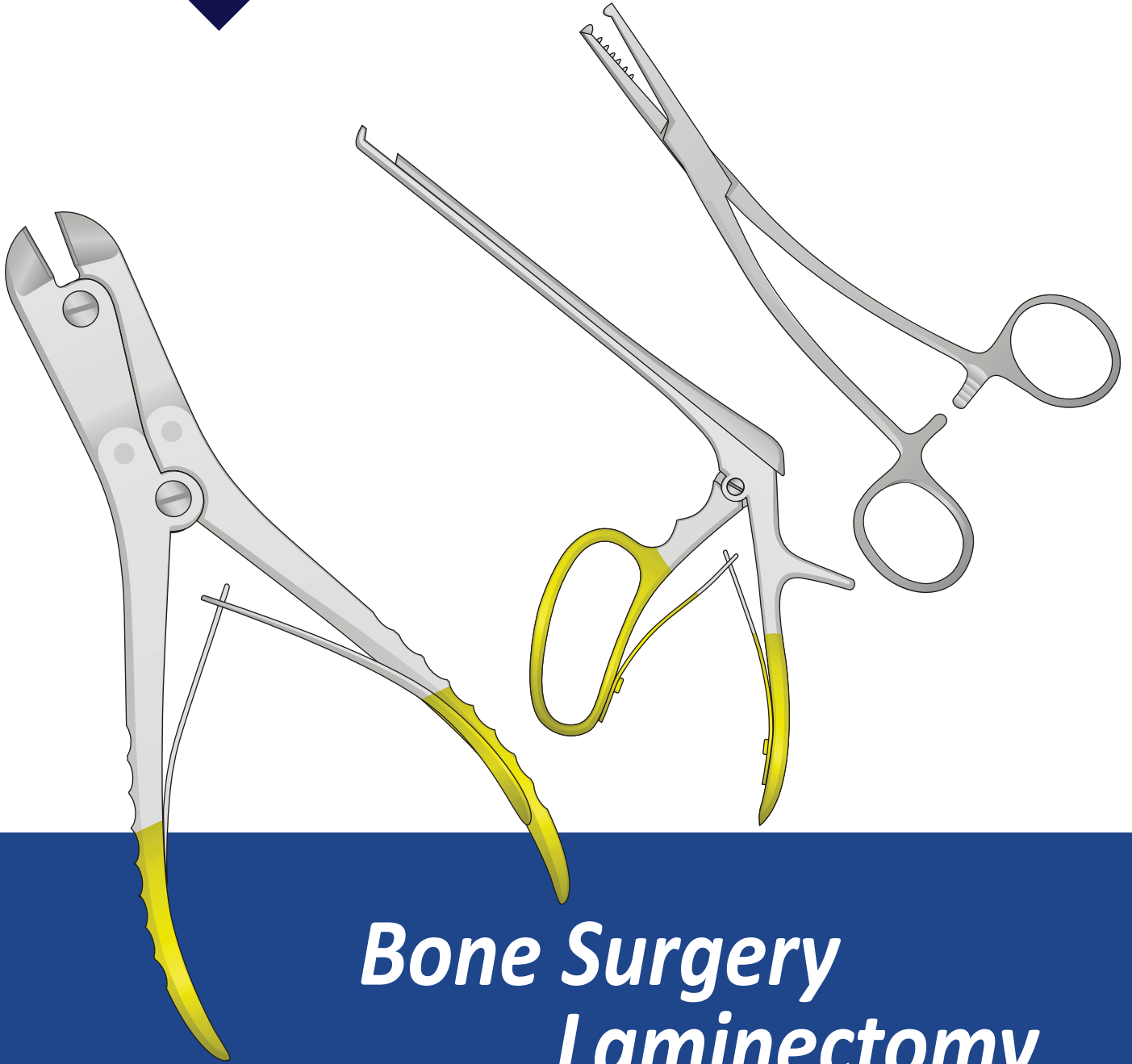








SAFE TOOL
MANUFACTURER & EXPORTER

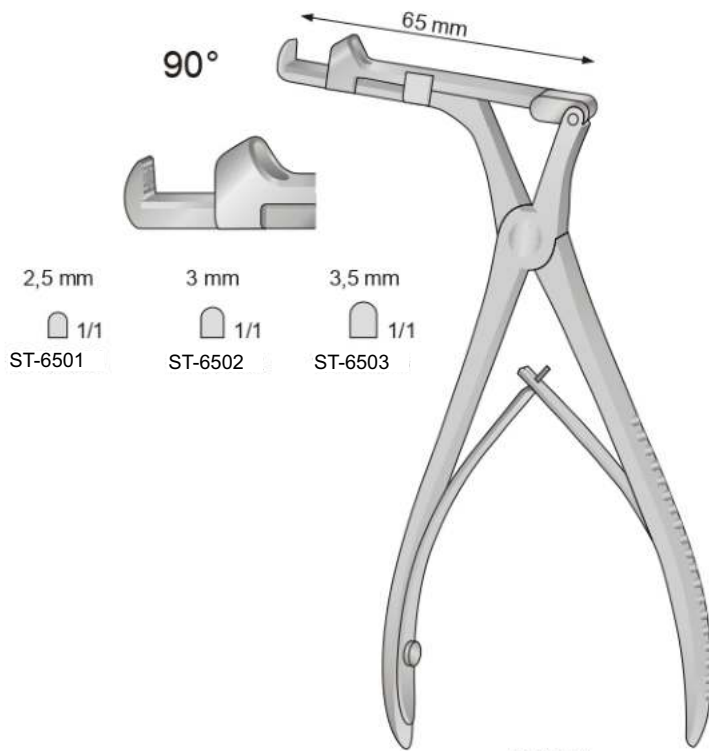


*Bone Surgery
Laminectomy*



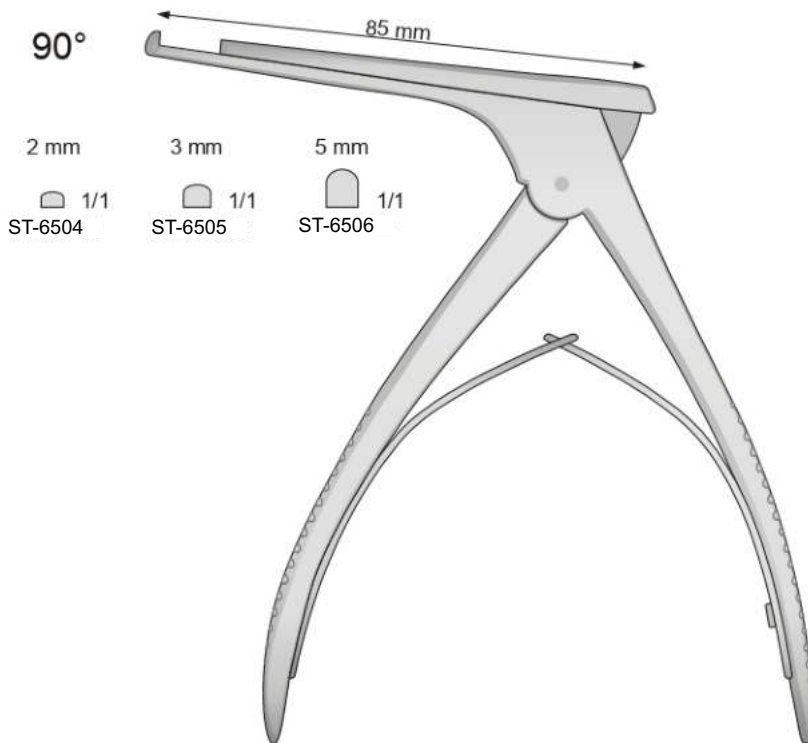
www.safetool.com.pk

*Surgical
Instruments*



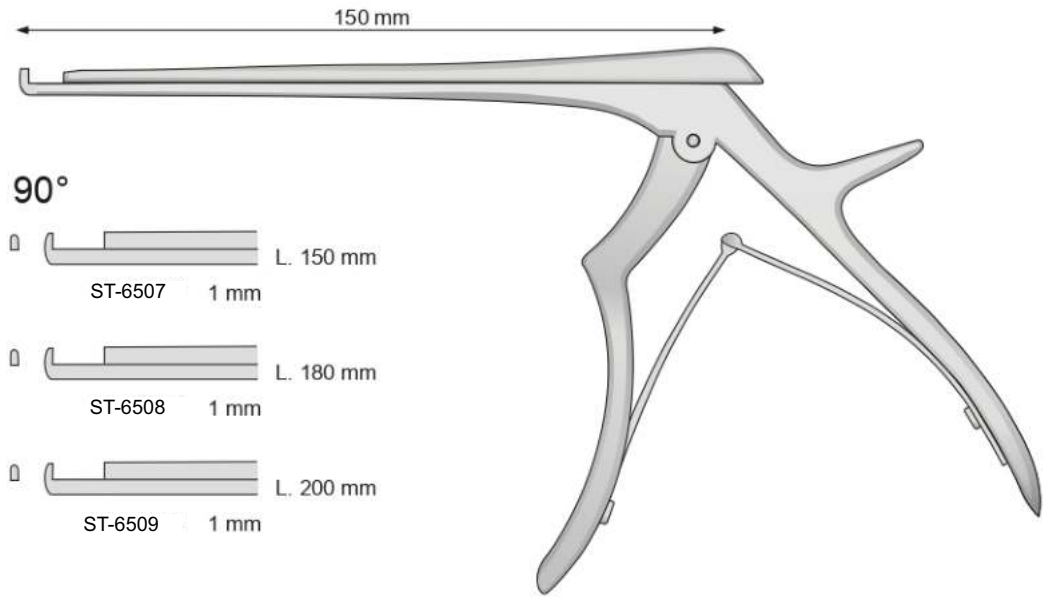
CITELLI

- ST-6501 2,5 mm
- ST-6502 3 mm
- ST-6503 3,5 mm

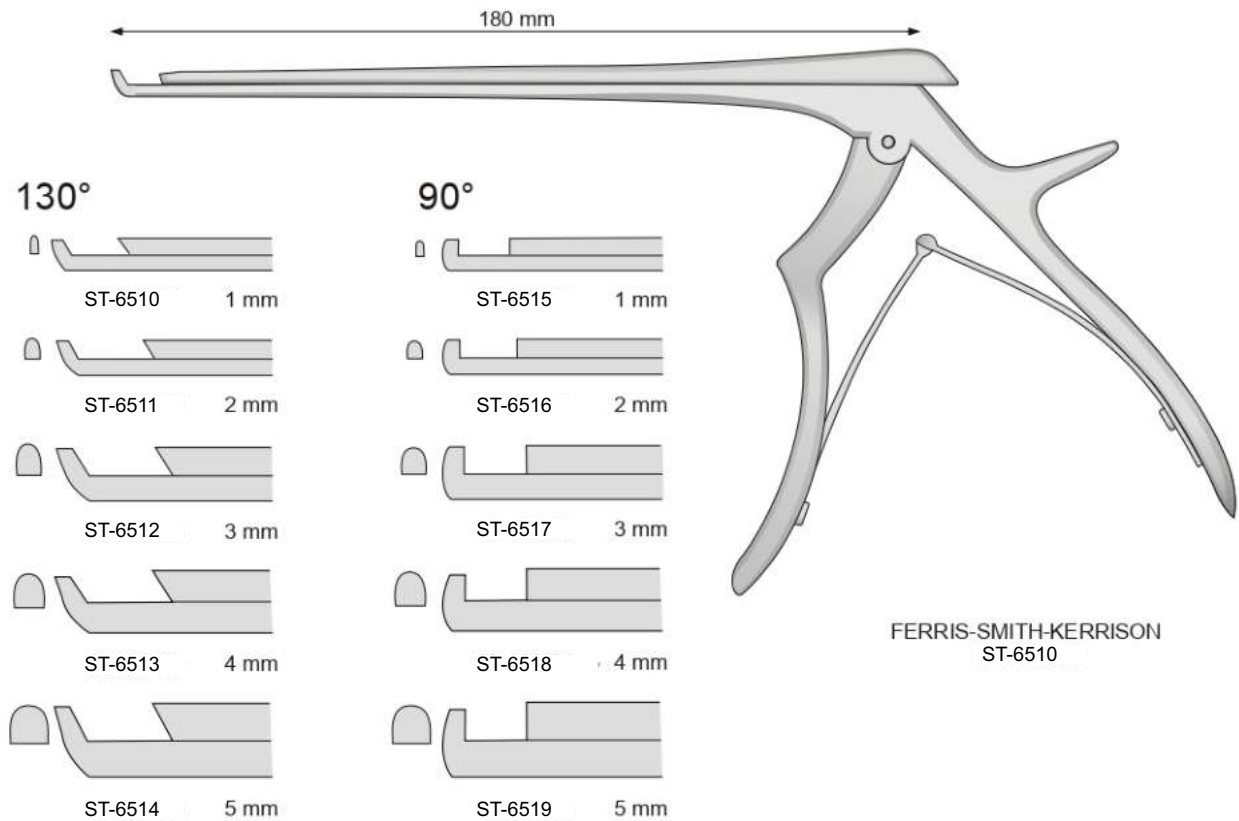


KERRISON

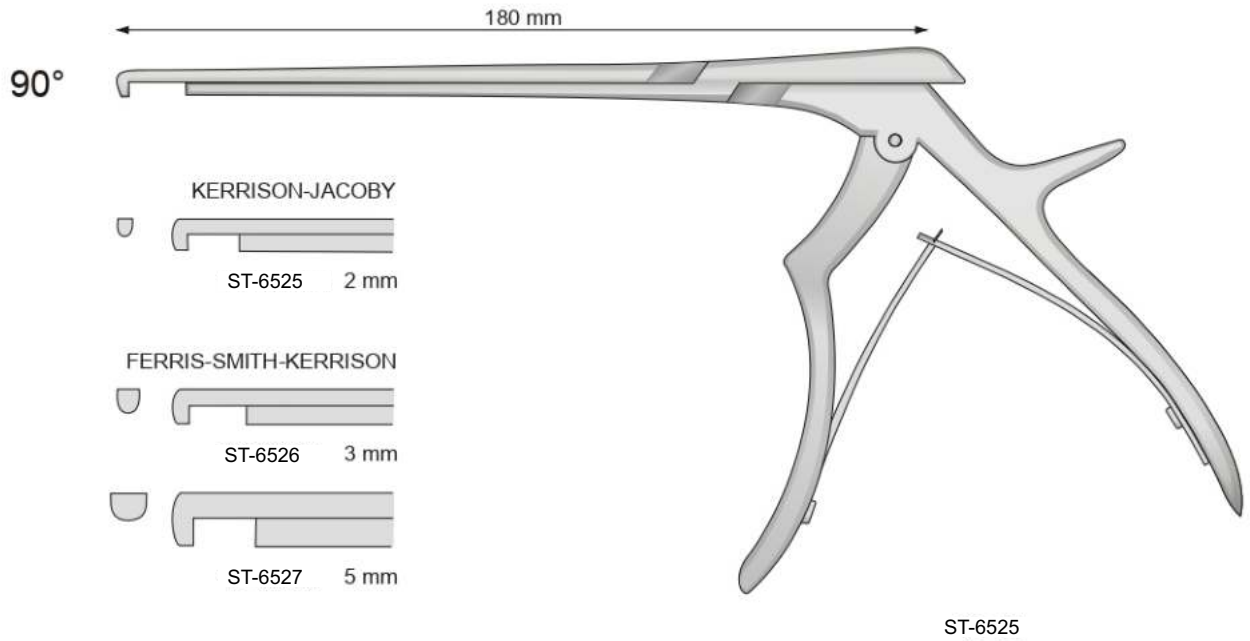
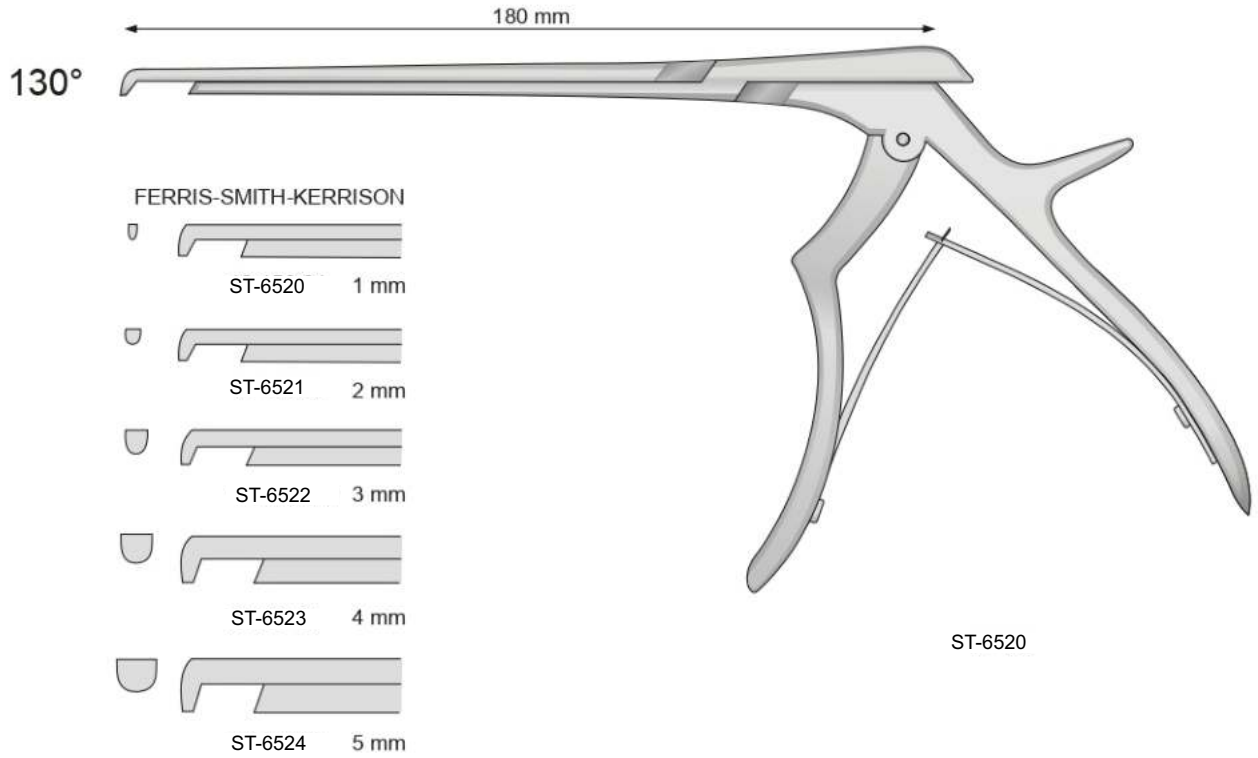
- ST-6504 2 mm
- ST-6505 3 mm
- ST-6506 5 mm

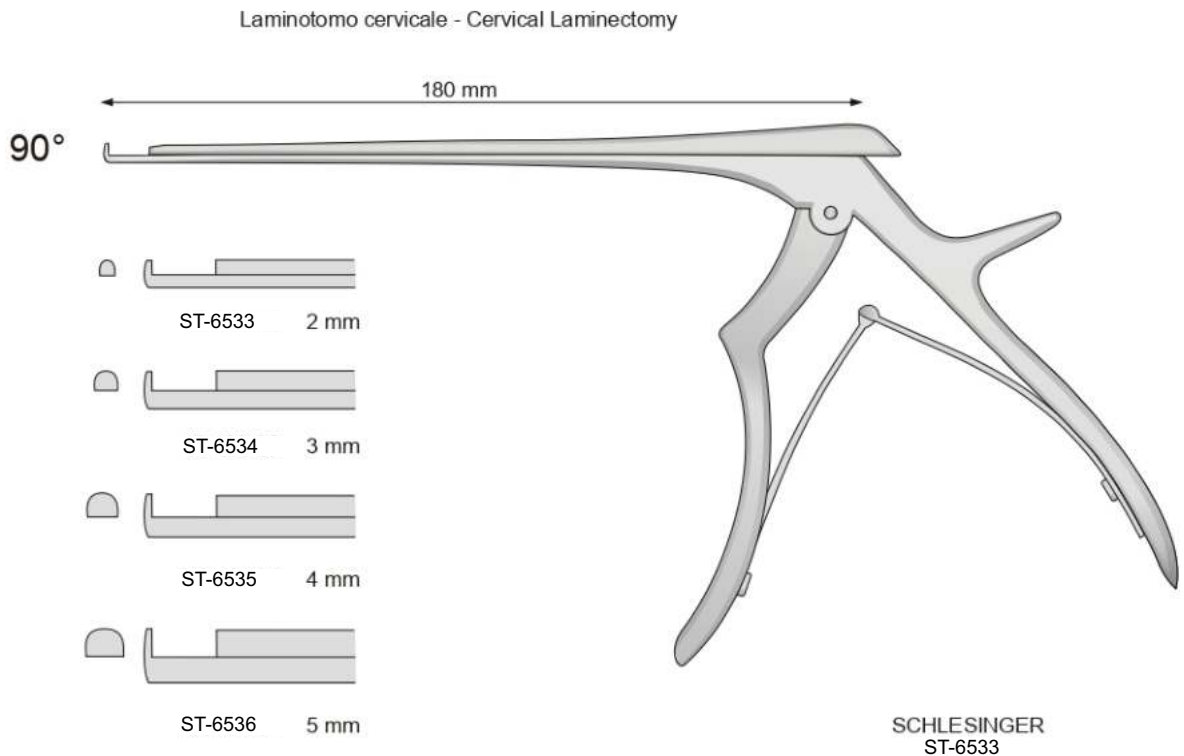
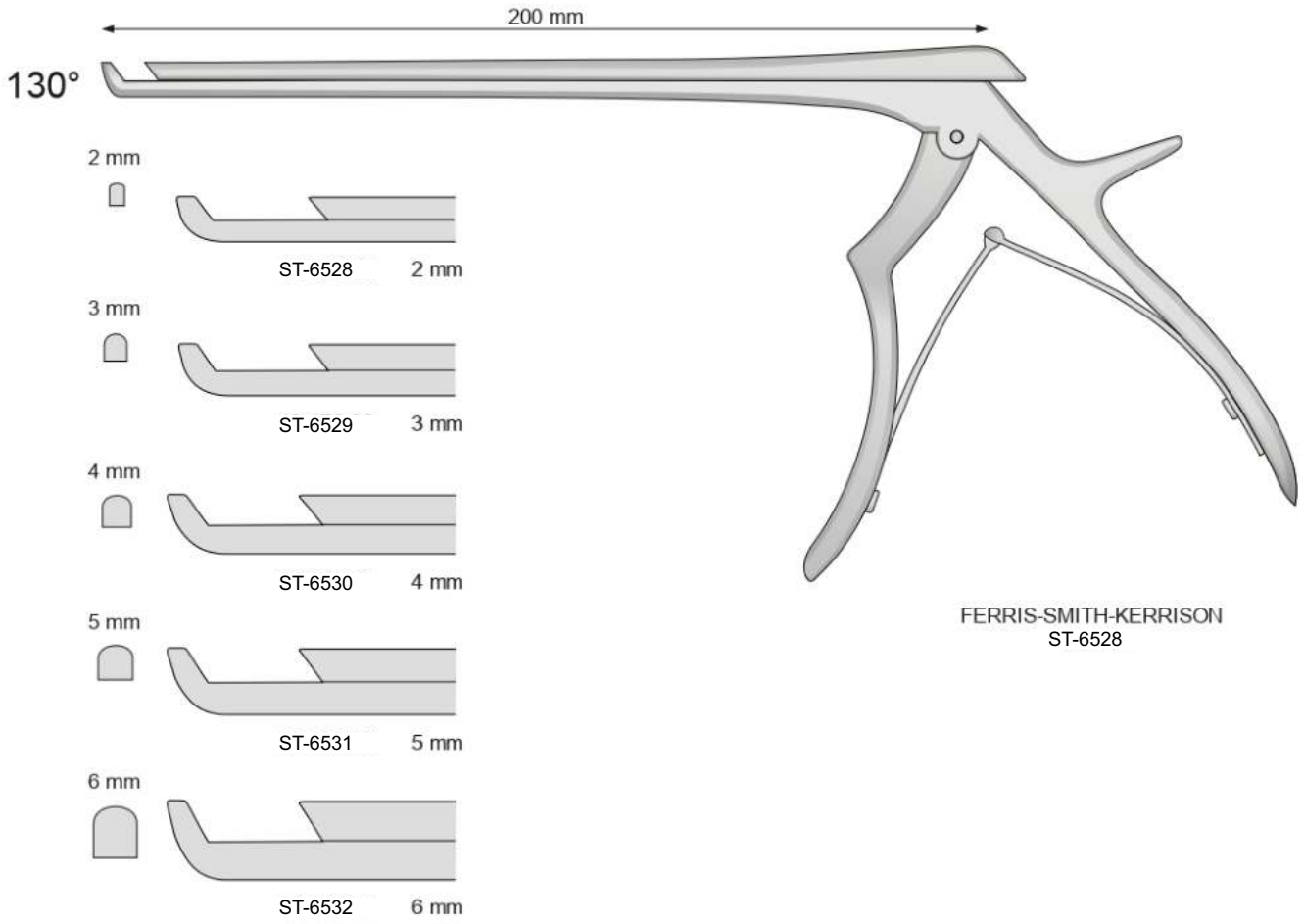


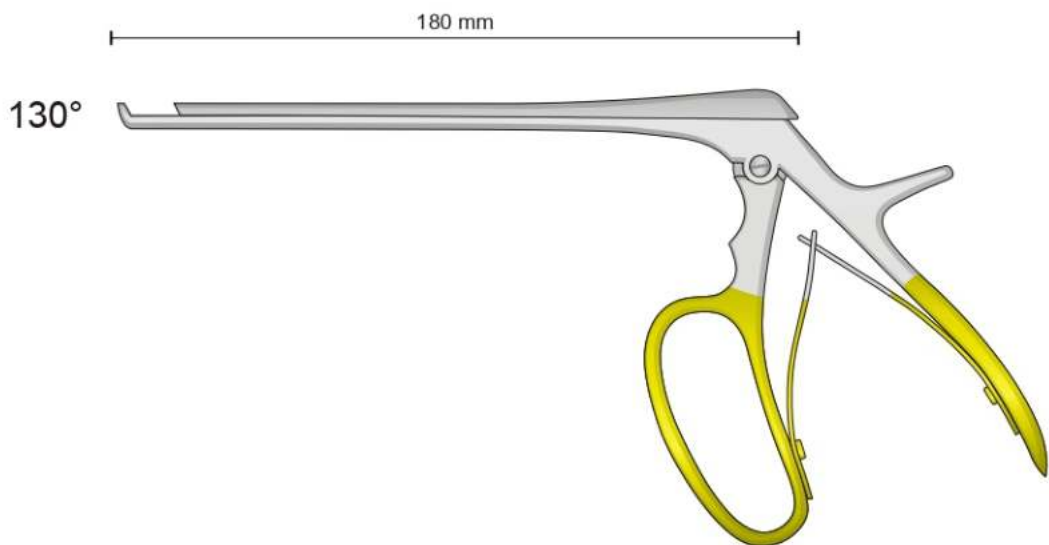
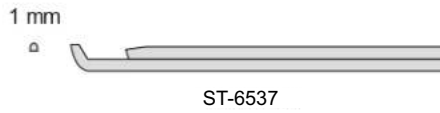
FERRIS-SMITH-KERRISON
ST-6507



FERRIS-SMITH-KERRISON
ST-6510







FERRIS - SMITH - KERRISON
ST-6537



Diritta
Stright
Gerade
Droites
Rectas



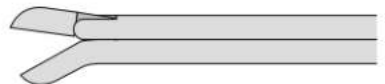
-  ST-6542 x 10 mm
-  ST-6543 x 10 mm
-  ST-6544 x 10 mm
-  ST-6545 x 12 mm

Curva verso l'alto
Top curved
Aufwärtsgebogen
Courbe vers le haut
Curvos

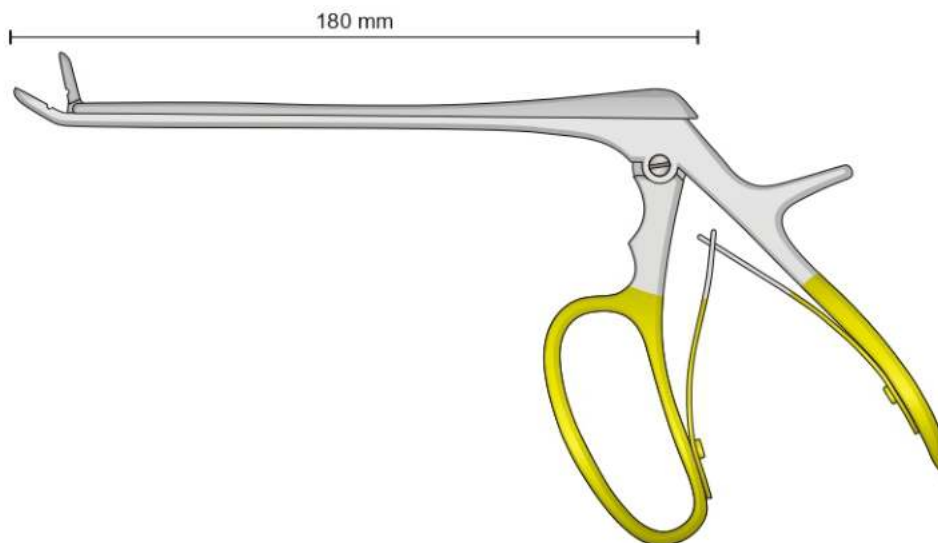


-  ST-6546 x 10 mm
-  ST-6547 x 10 mm
-  ST-6548 x 10 mm

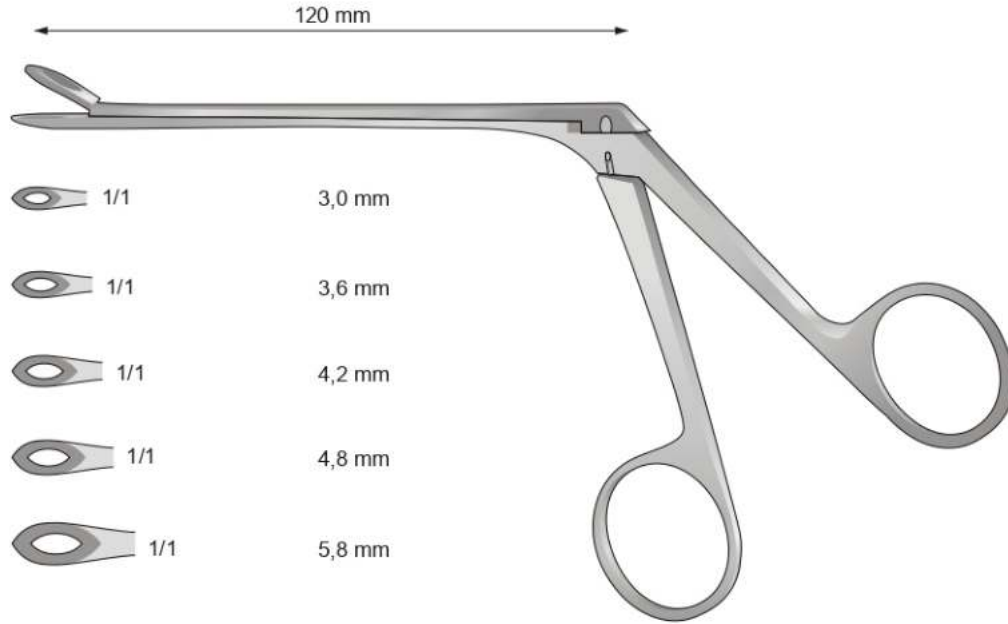
Curva verso il basso
Bottom curved
Abwärts gebogen
Courbe vers le bas
Curvos



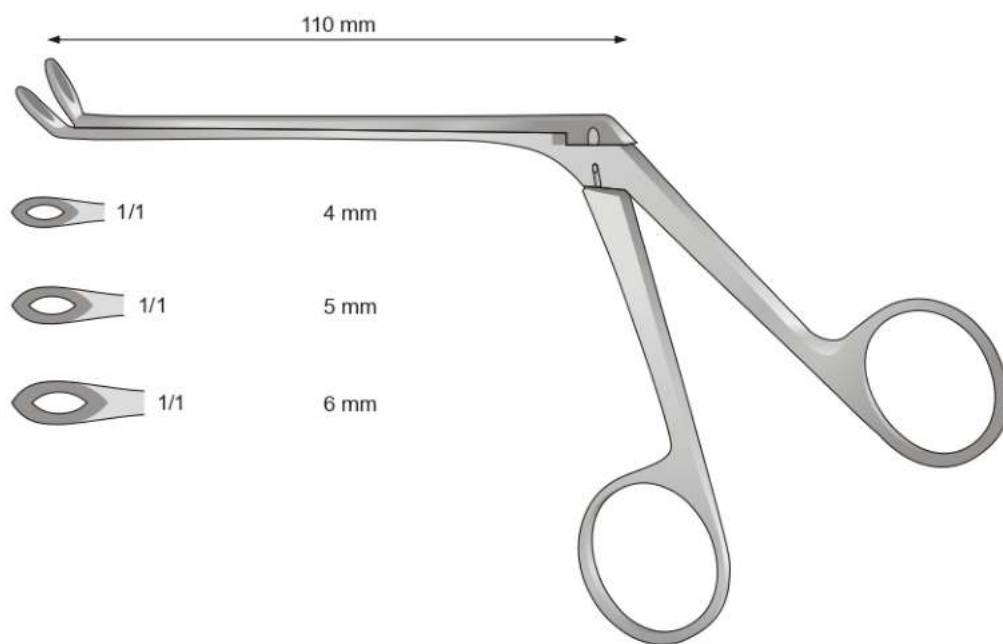
-  ST-6549 x 10 mm
-  ST-6550 x 10 mm
-  ST-6551 x 10 mm



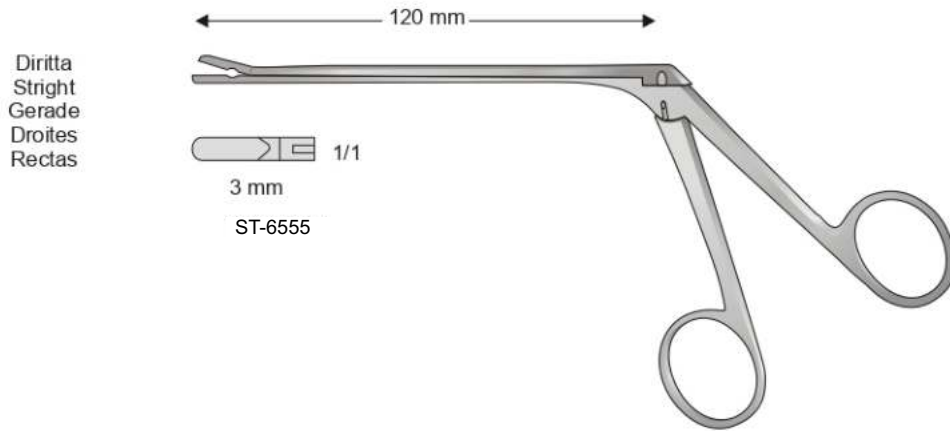
FERRIS - SMITH - CUSHING
ST-6542



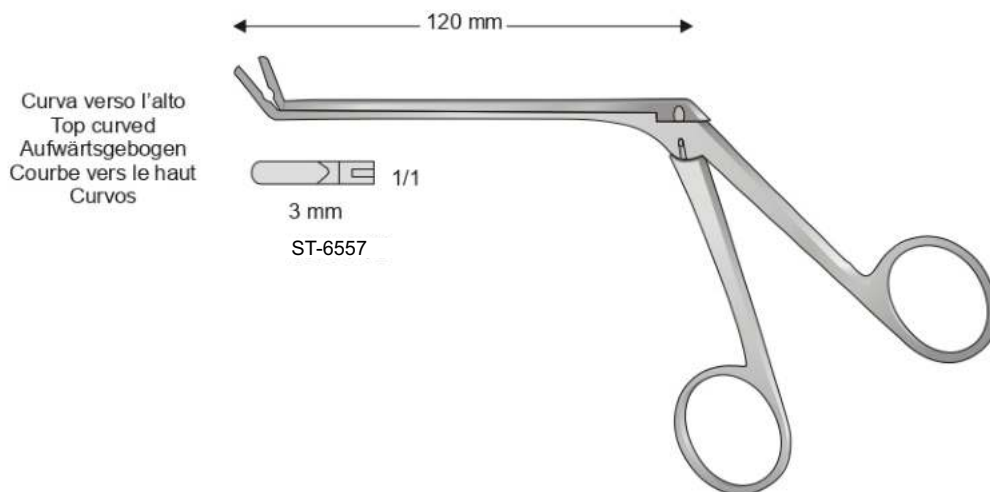
WEIL-BLAKESLEY
ST-6552
190mm



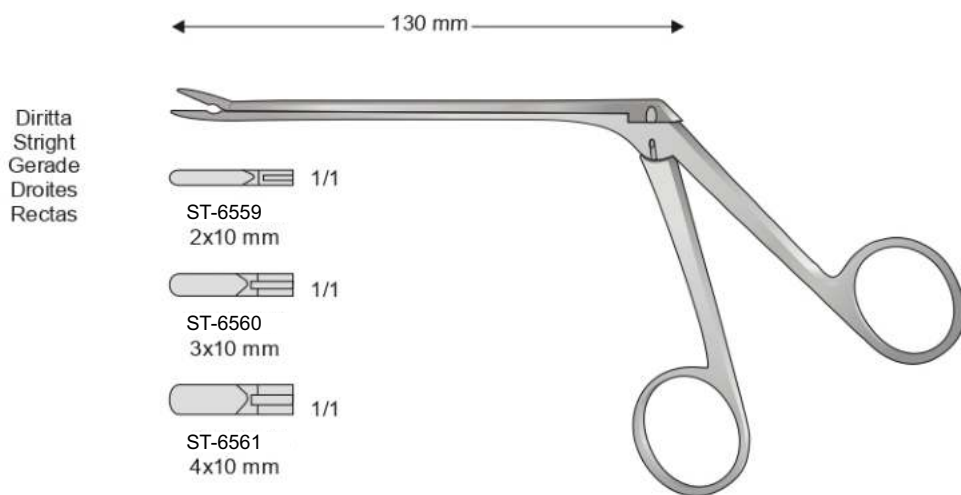
WEIL-BLAKESLEY
ST-6553
190mm



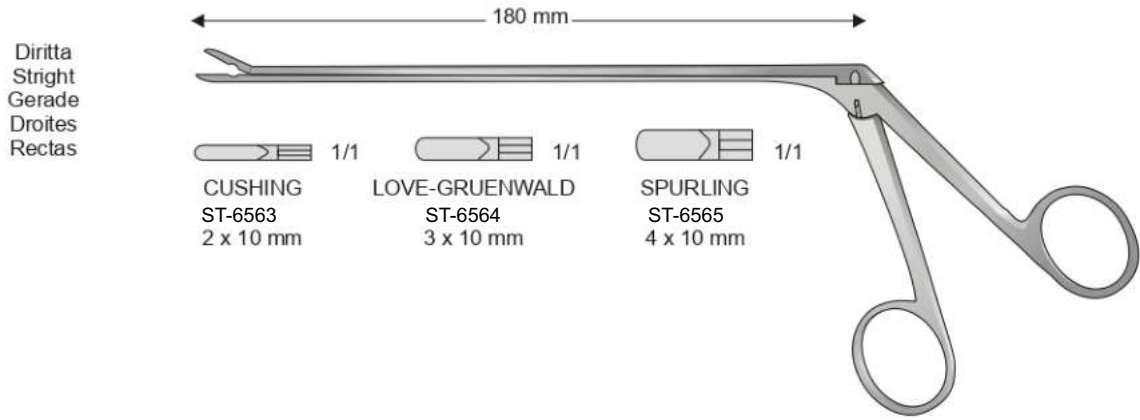
TAKAHASHI
ST-6554



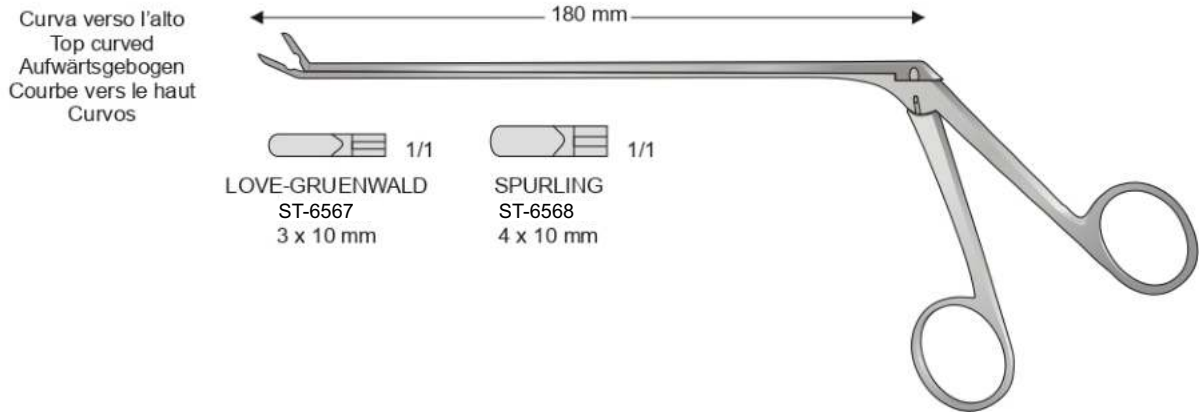
TAKAHASHI
ST-6556



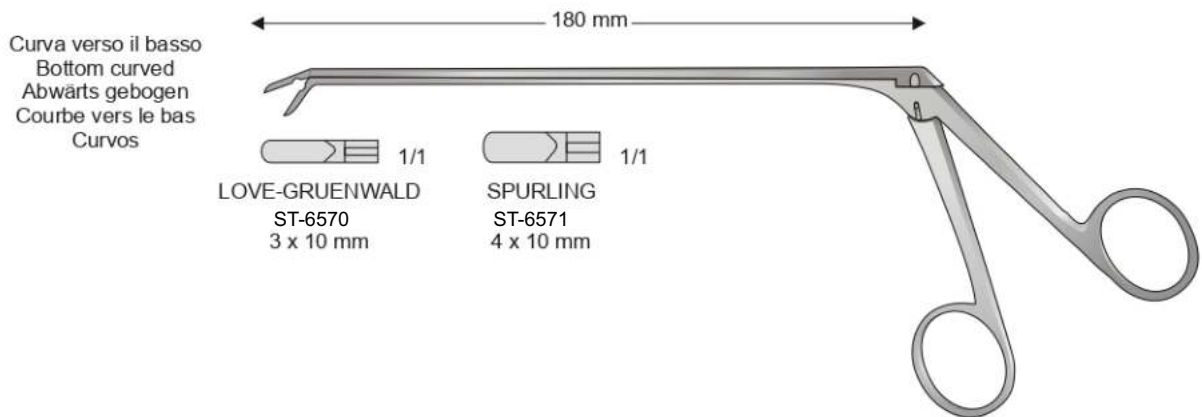
LOVE-GRUENWALD
ST-6558



ST-6562

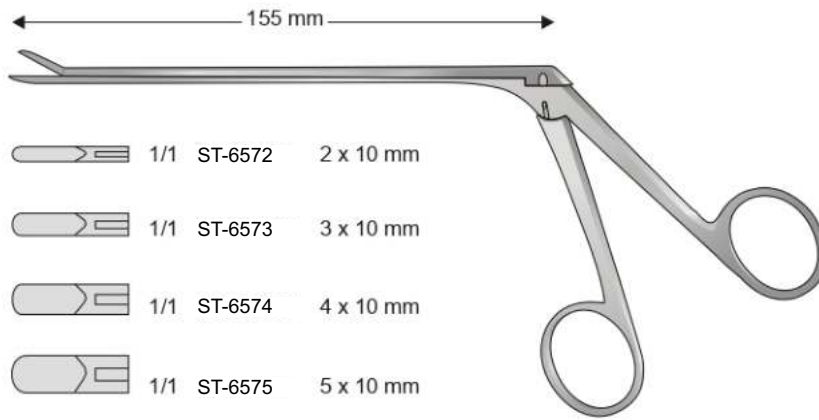


ST-6566



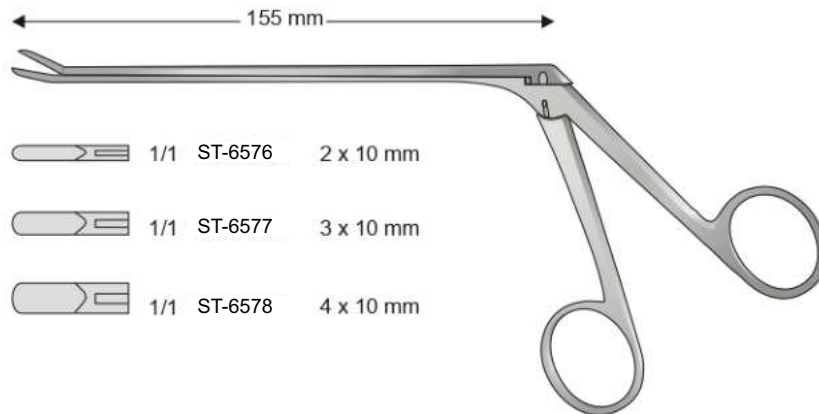
ST-6569

Diritta
Stright
Gerade
Droites
Rectas



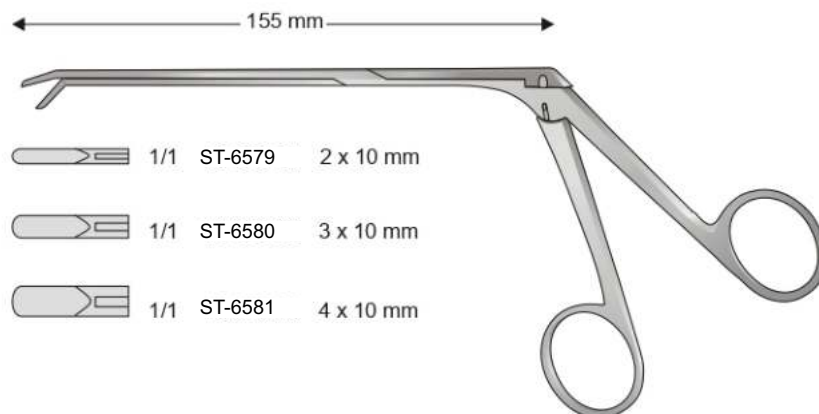
CASPAR
ST-6572

Curva verso l'alto
Top curved
Aufwärtsgebogen
Courbe vers le haut
Curvos



CASPAR
ST-6576

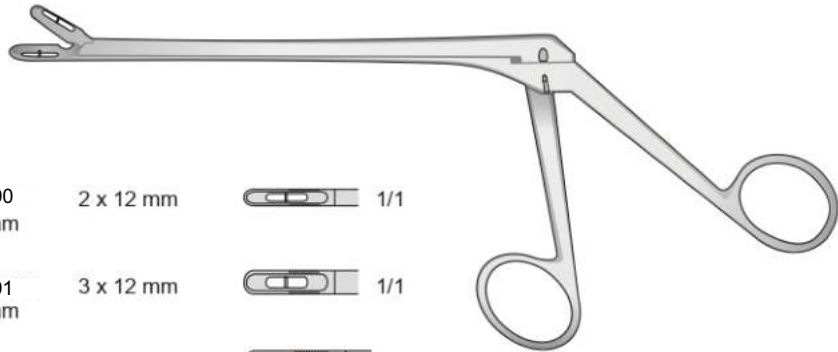
Curva verso il basso
Bottom curved
Abwärts gebogen
Courbe vers le bas
Curvos






CASPAR
ST-6579



Diritta
Stright
Gerade
Droites
Rectas



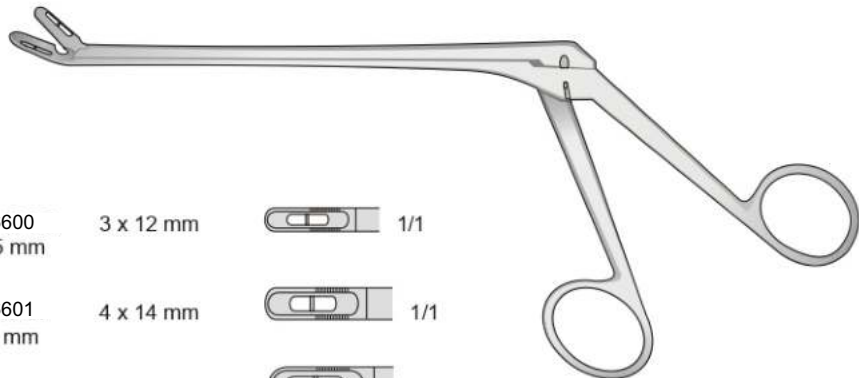
CASPAR

ST-6582 140 mm	ST-6585 160 mm	ST-6590 185 mm	2 x 12 mm		1/1
ST-6583 140 mm	ST-6586 160 mm	ST-6591 185 mm	3 x 12 mm		1/1
ST-6584 140 mm	ST-6587 160 mm	ST-6592 185 mm	4 x 14 mm		1/1
	ST-6588 160 mm	ST-6593 185 mm	5 x 14 mm		1/1
	ST-6589 160 mm	ST-6594 185 mm	6 x 16 mm		1/1



CASPAR
ST-6582

Curva verso l'alto
Top curved
Aufwärtsgebogen
Courbe vers le haut
Curvos

150°



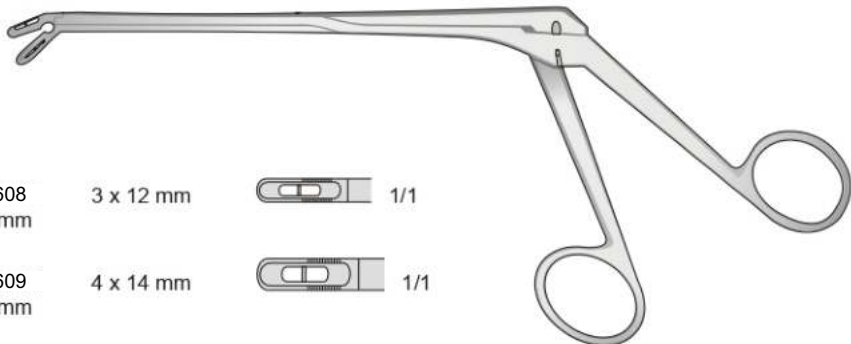
CASPAR

ST-6595 140 mm	ST-6597 160 mm	ST-6600 185 mm	3 x 12 mm		1/1
ST-6596 140 mm	ST-6598 160 mm	ST-6601 185 mm	4 x 14 mm		1/1
	ST-6599 160 mm	ST-6602 185 mm	5 x 14 mm		1/1

CASPAR
ST-6595

Curva verso il basso
Bottom curved
Abwärts gebogen
Courbe vers le bas
Curvos

150°



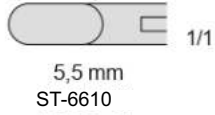
CASPAR

ST-6604 140 mm	ST-6606 160 mm	ST-6608 185 mm	3 x 12 mm		1/1
ST-6605 140 mm	ST-6607 160 mm	ST-6609 185 mm	4 x 14 mm		1/1

CASPAR
ST-6603

Diritta
Stright
Gerade
Droites
Rectas

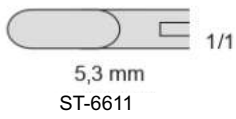
← 210 mm →



WAGNER
ST-6610

Diritta
Stright
Gerade
Droites
Rectas

← 255 mm →



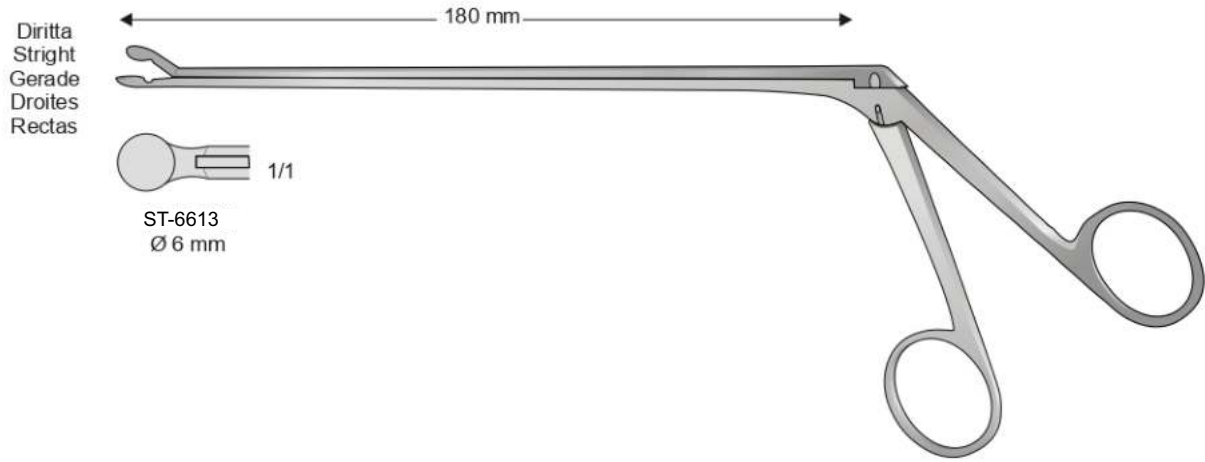
ST-6611

Curva verso l'alto
Top curved
Aufwärtsgebogen
Courbe vers le haut
Curvos

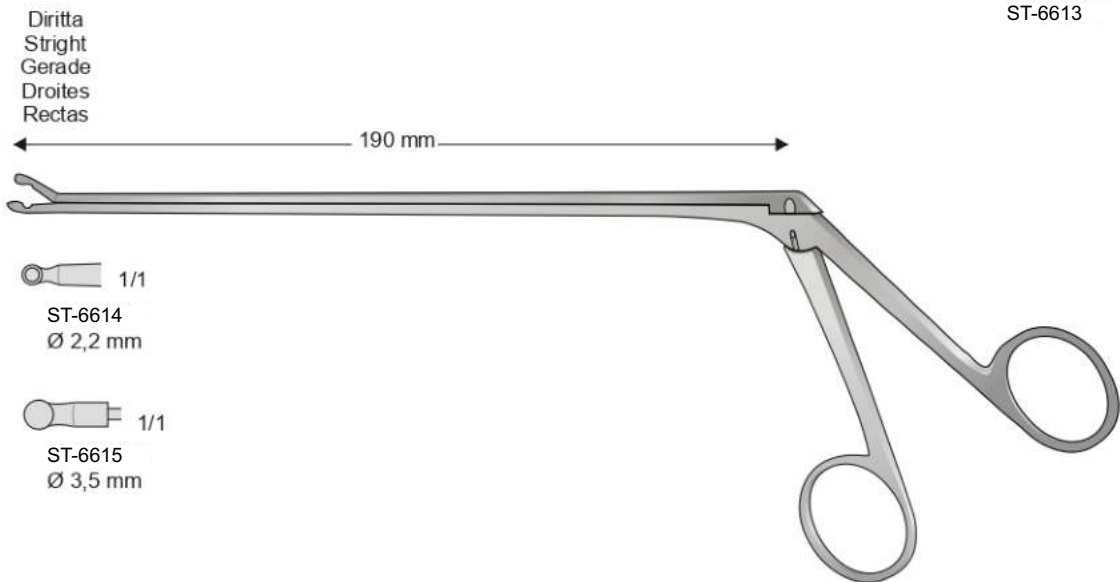
← 255 mm →



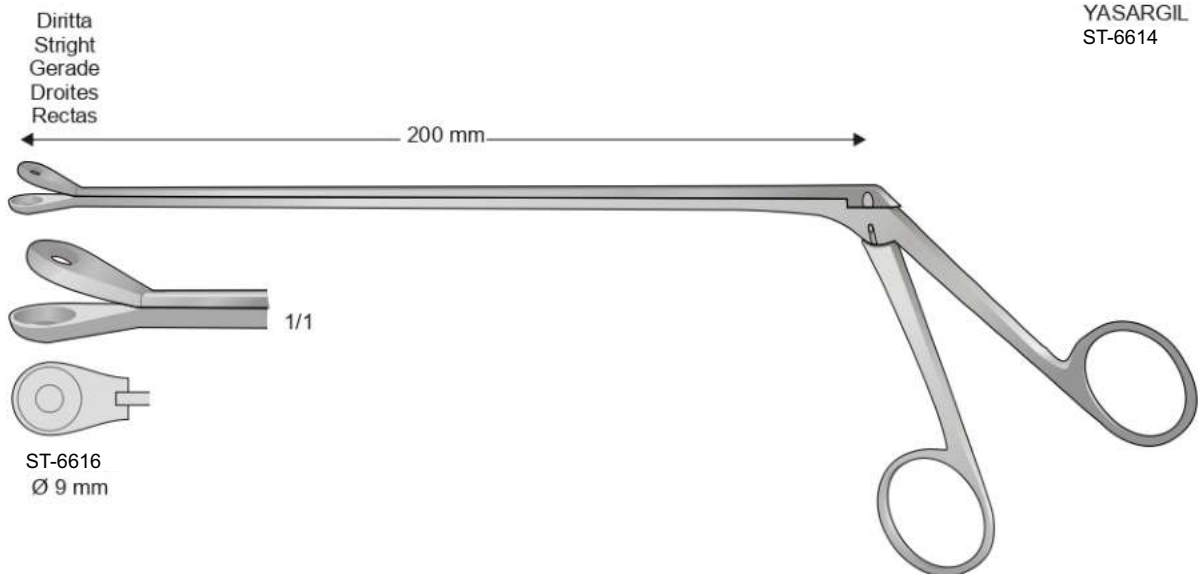
SYPERT
ST-6612



OLDBERG
ST-6613



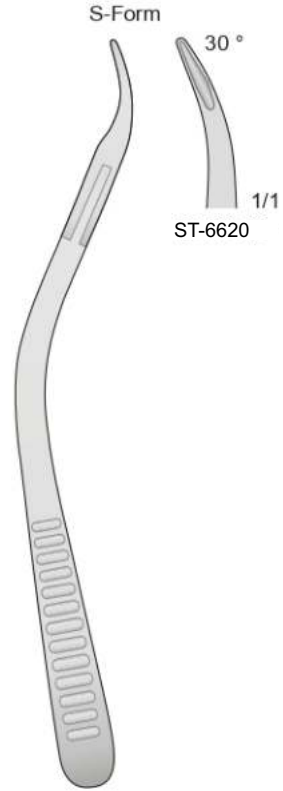
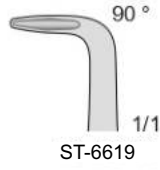
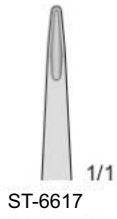
YASARGIL
ST-6614



LANDOLT
ST-6616



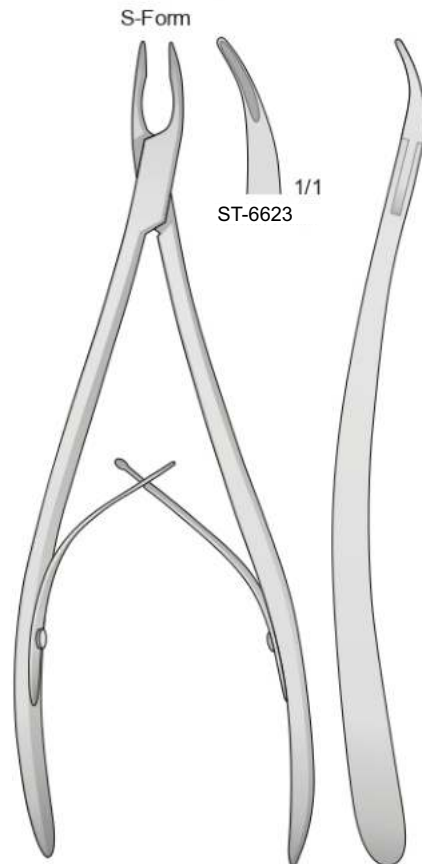
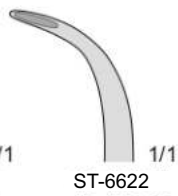
MINI-FRIEDMANN
ST-6617
150 mm



MINI-FRIEDMANN
ST-6620
145 mm

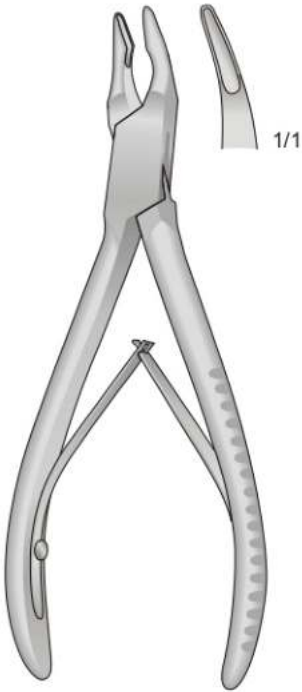


STELLBRINK
ST-6621
170 mm

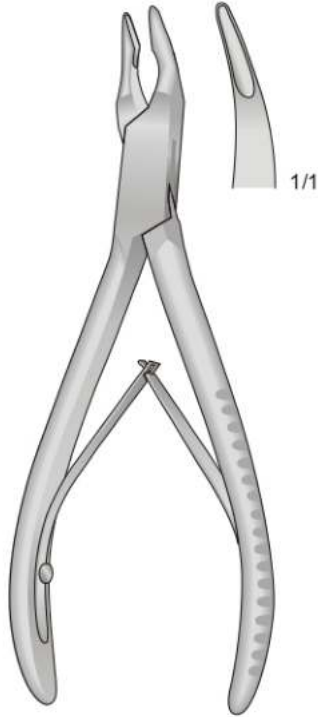


STELLBRINK
ST-6623
190 mm

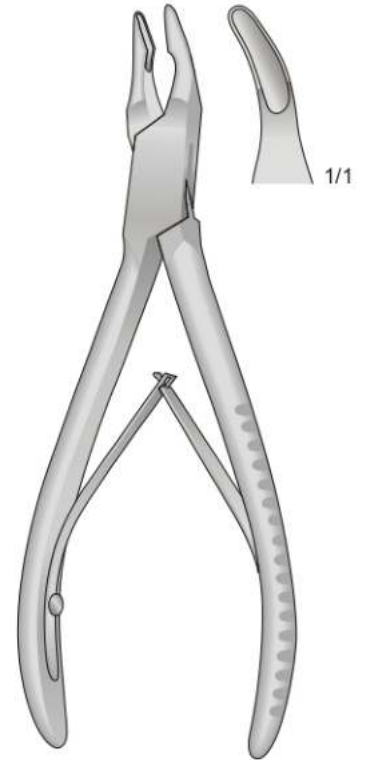




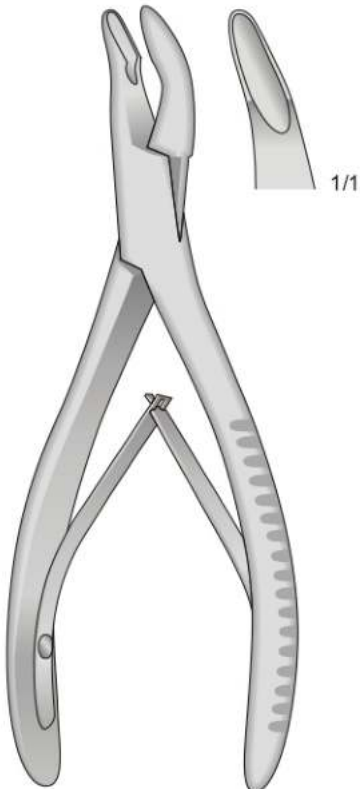
MINI FRIEDMANN
ST-6624
120 mm



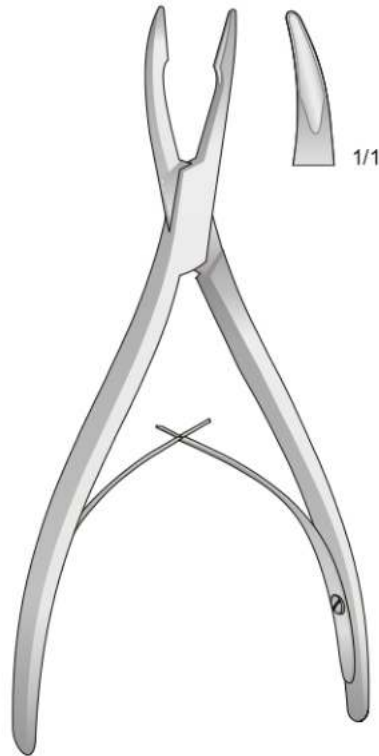
FRIEDMANN
ST-6625
140 mm



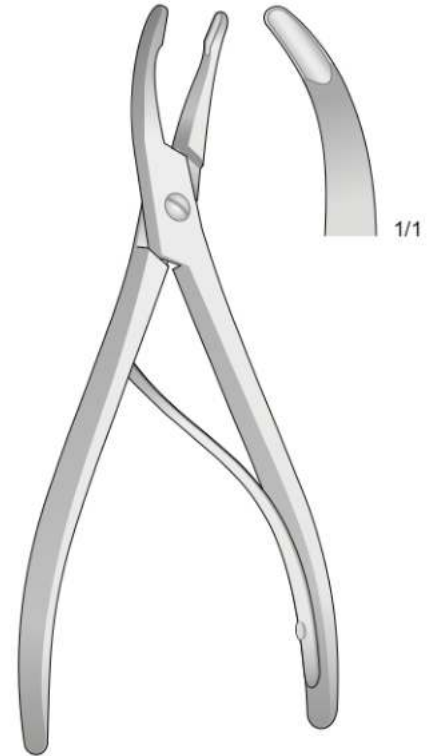
BLUMENTHAL
ST-6626
155 mm



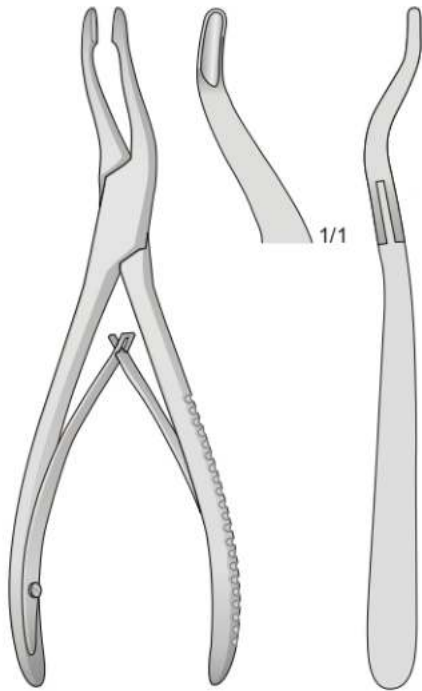
MEAD
ST-6627
165 mm



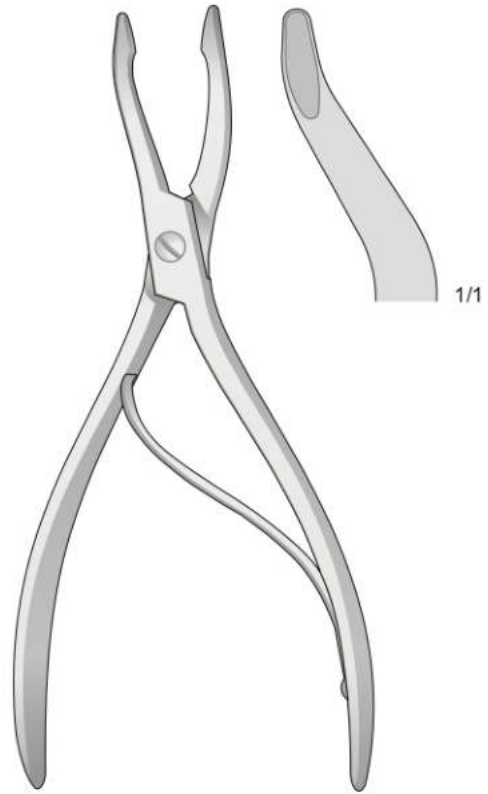
FRIEDMANN
ST-6628
160 mm



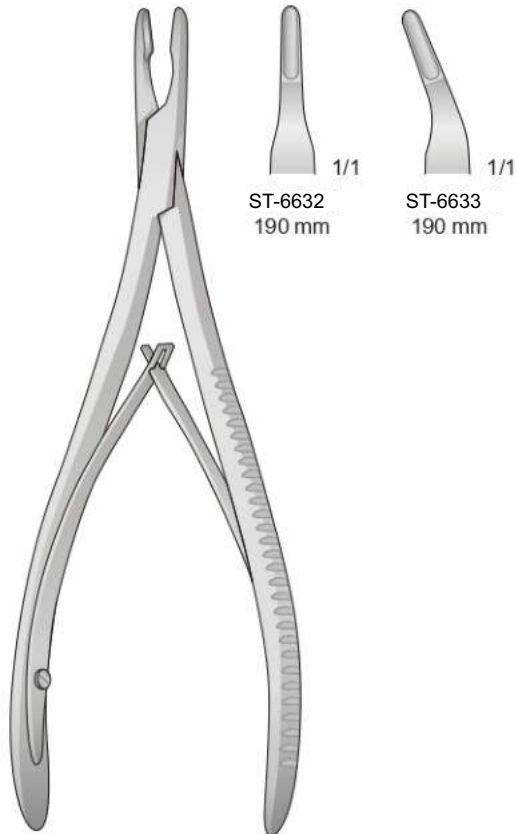
LUER
ST-6629
155 mm



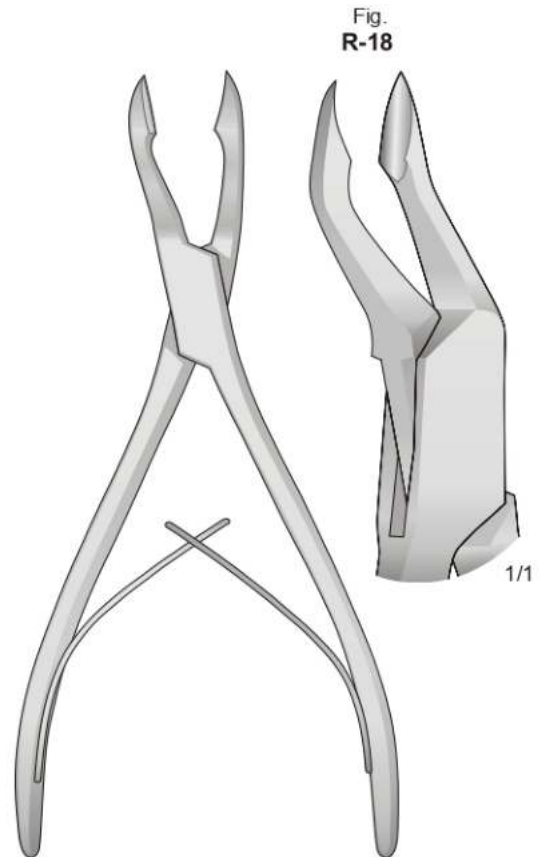
ALEXANDER
ST-6630
140 mm



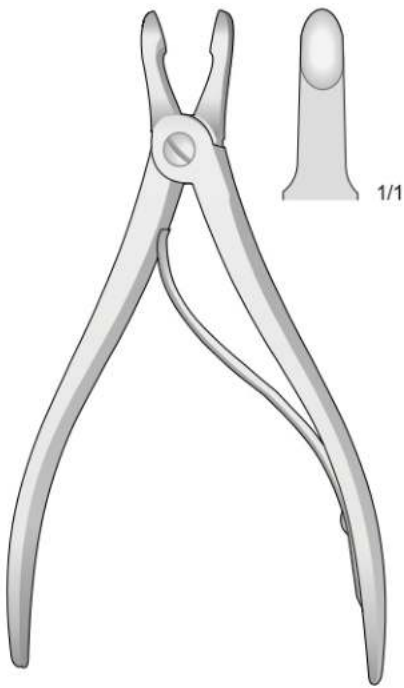
JANSEN-LEUER
ST-6631
180 mm



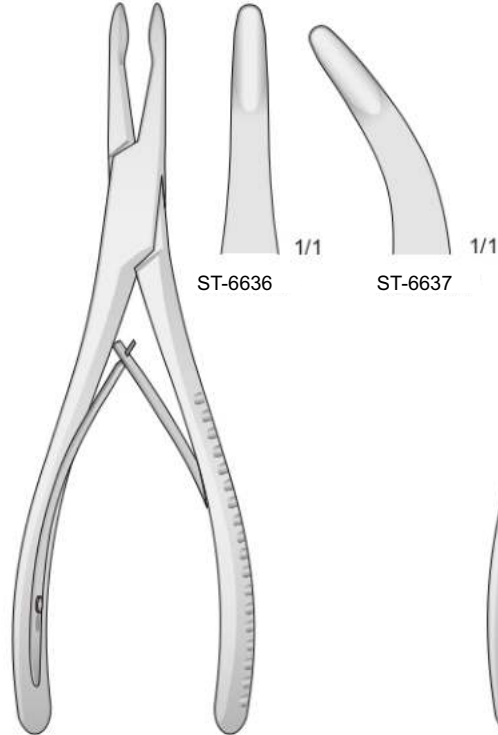
LEMPERT
ST-6632
190 mm



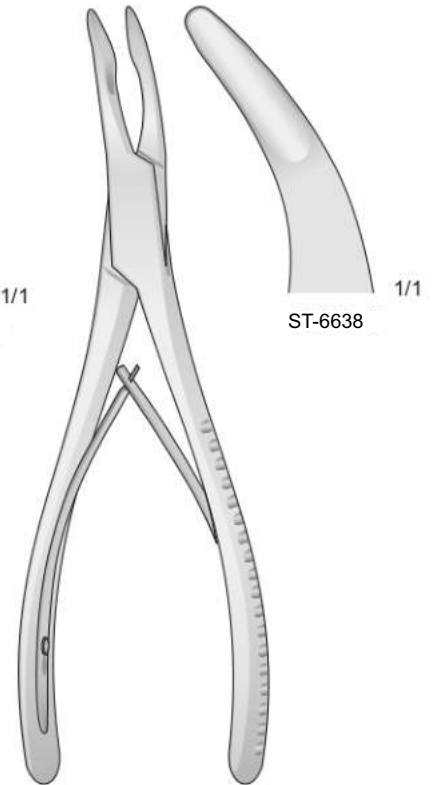
ST-6634
175 mm



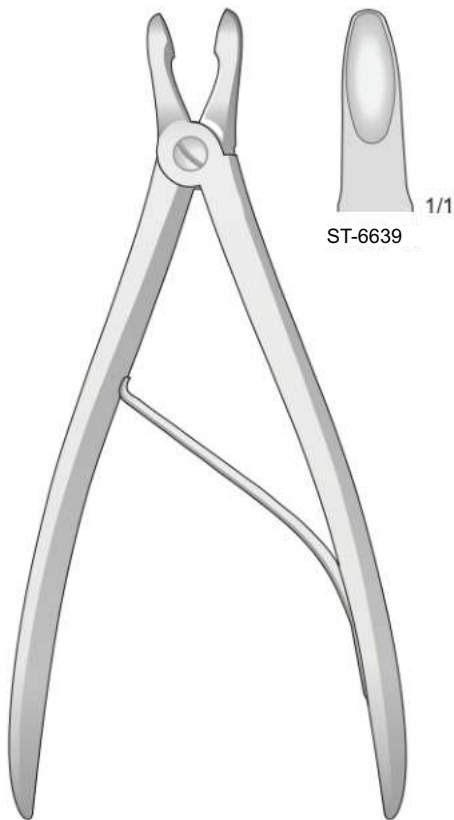
HARTMANN
ST-6635
155 mm



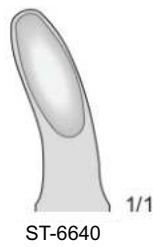
JANSEN
ST-6636
170 mm



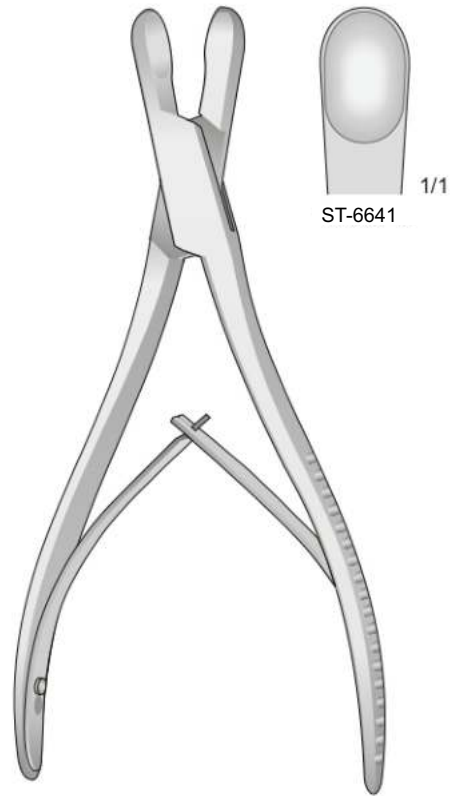
OLIVECRONA
ST-6638
190 mm



CUSHING
ST-6639
190 mm



ST-6640
1/1



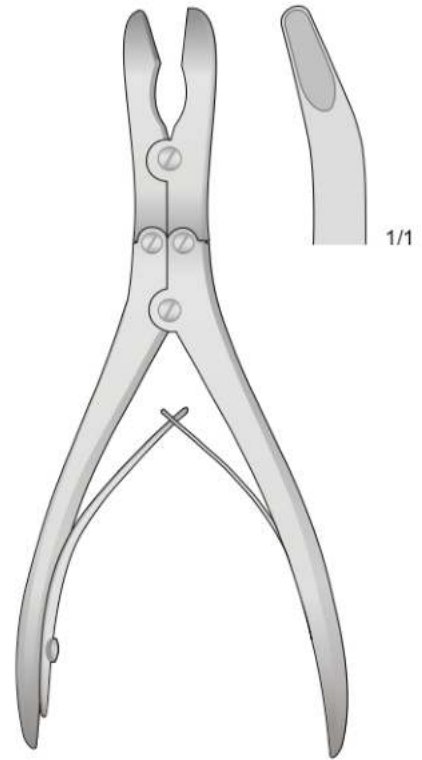
LUER-STILLE
ST-6641
185 mm



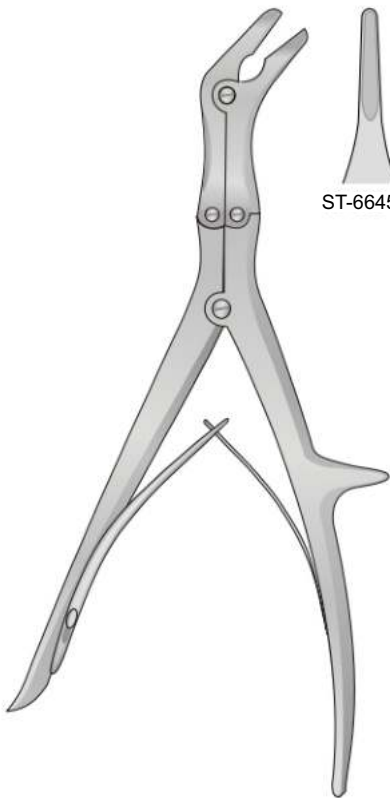
BEYER
ST-6642
180 mm



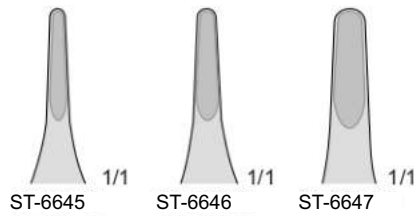
ZAUFAL-JANSEN
ST-6643
180 mm



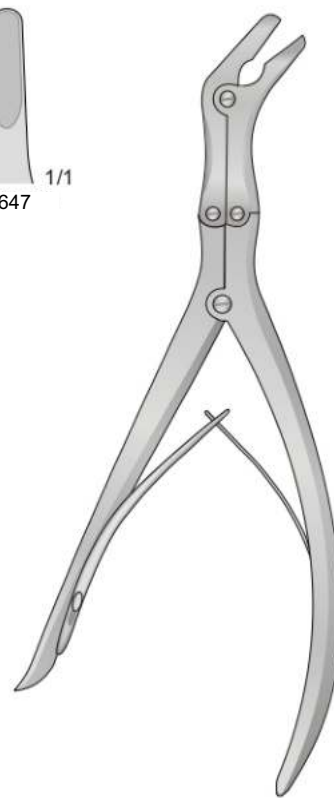
RUSKIN-STILLE
ST-6644
180 mm



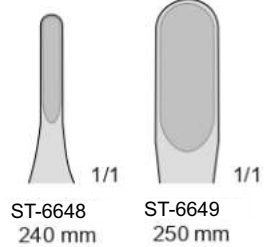
ECHLIN
ST-6645
230 mm



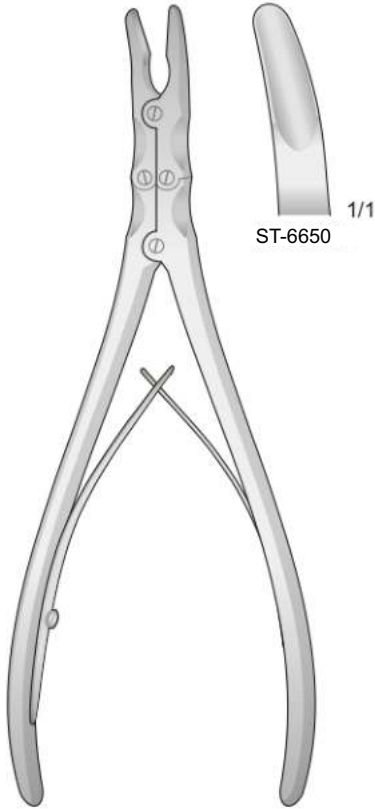
ST-6645 1/1 ST-6646 1/1 ST-6647 1/1



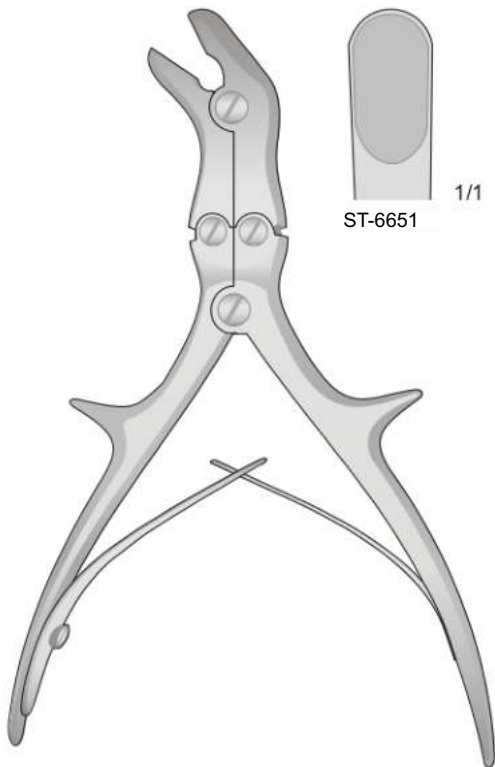
LEKSELL
ST-6648



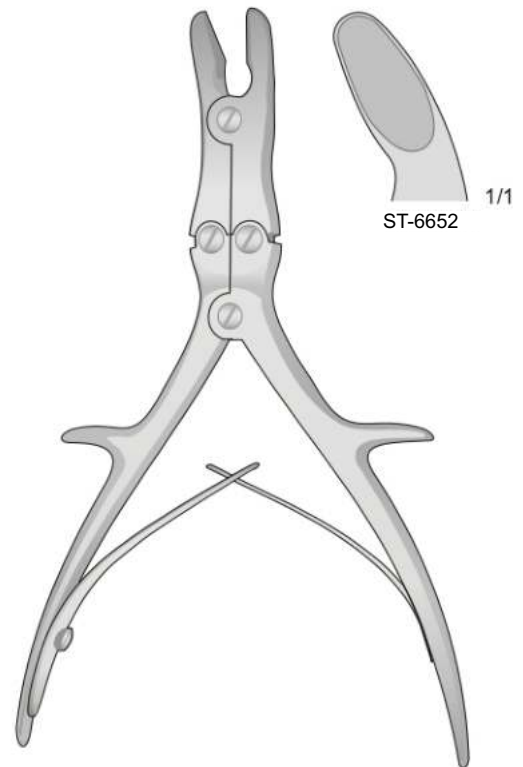
ST-6648 1/1 ST-6649 1/1
240 mm 250 mm



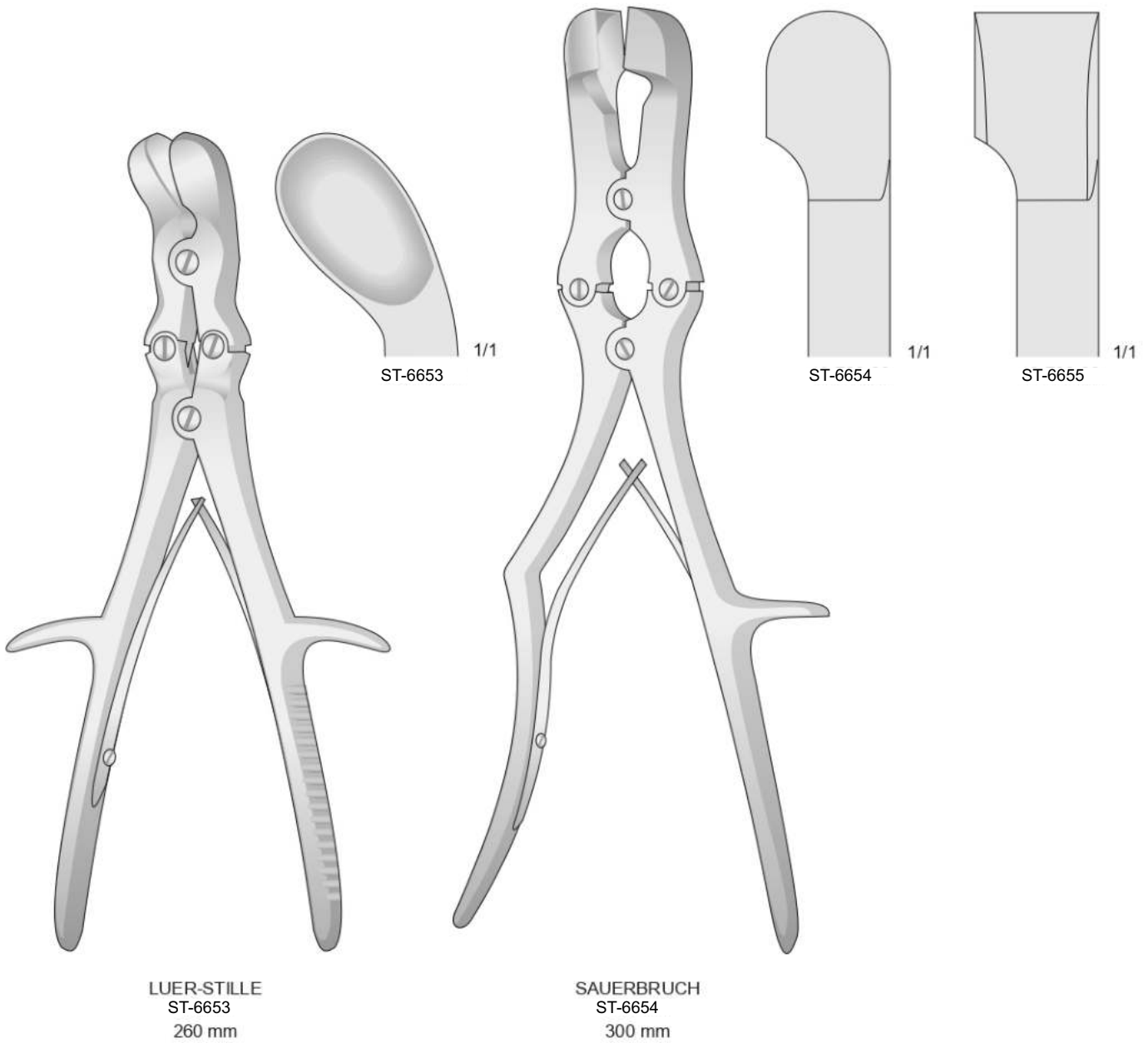
RÖTTGEN-RUSKIN
ST-6650
240 mm

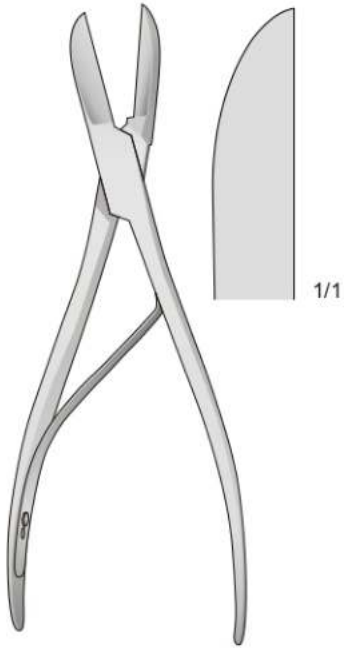


STILLE
ST-6651
210 mm

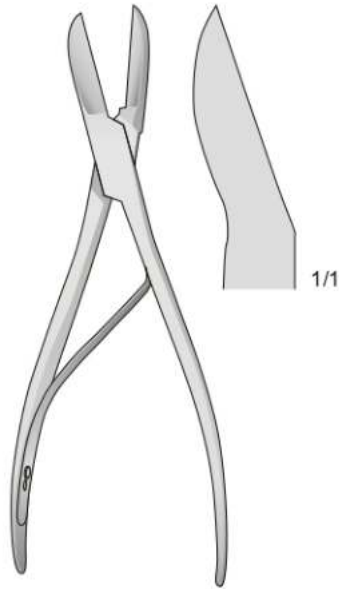


LUER-STILLE
ST-6652
210 mm

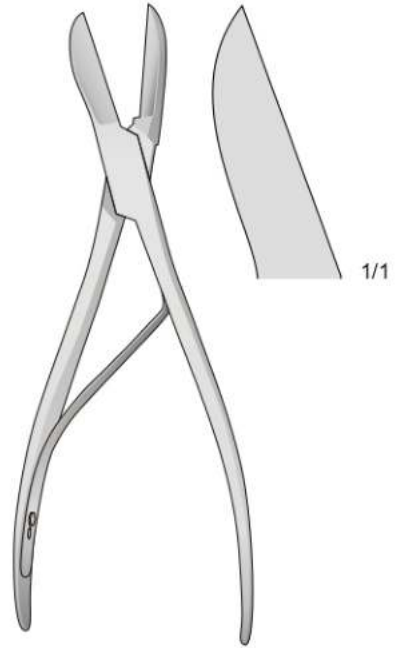




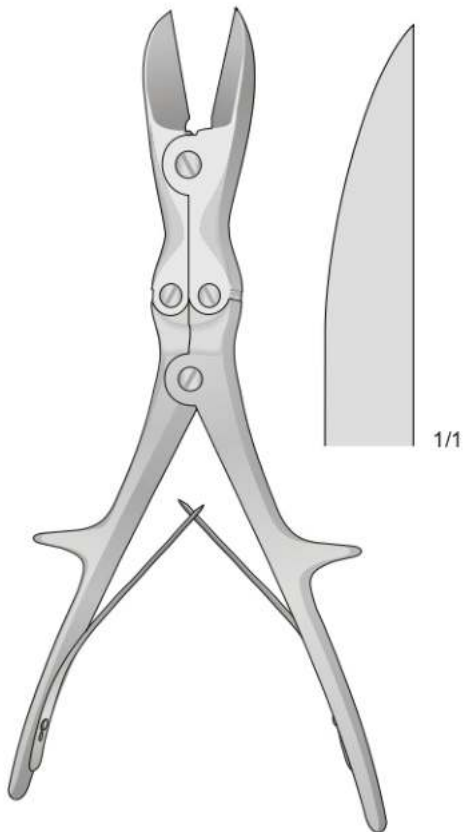
LISTON
ST-6656
220 mm



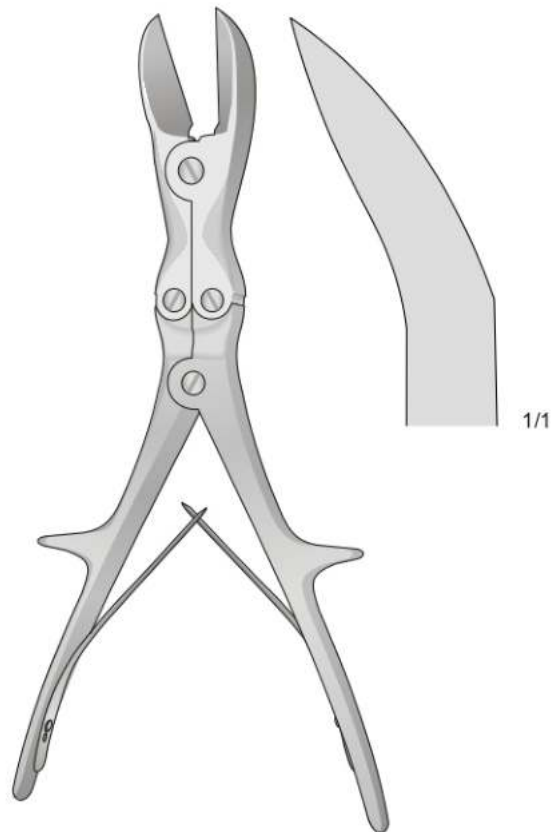
LISTON
ST-6657
170 mm



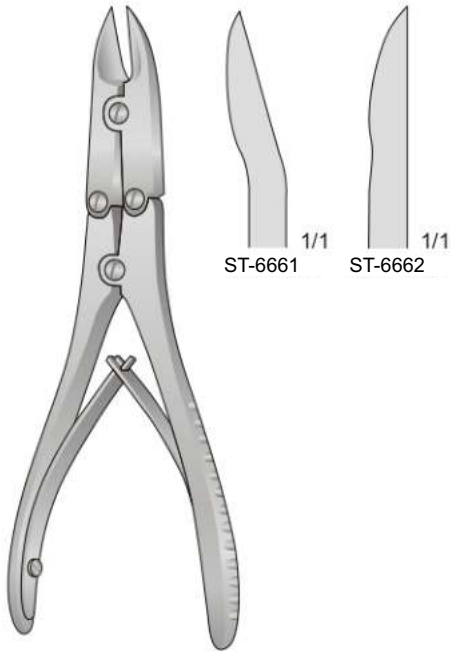
LISTON
ST-6658
220 mm



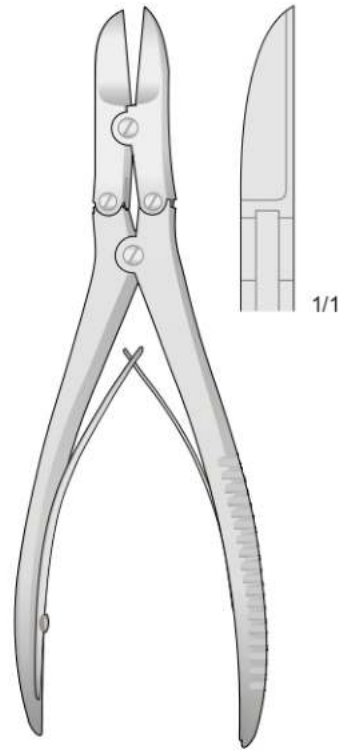
LISTON
ST-6659
270 mm



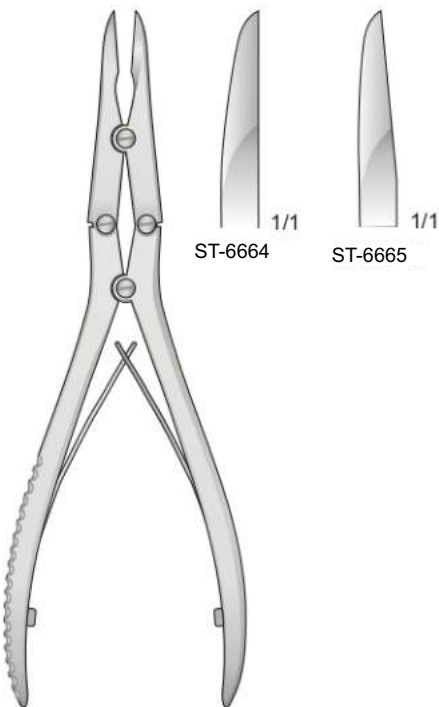
LISTON
ST-6660
270 mm



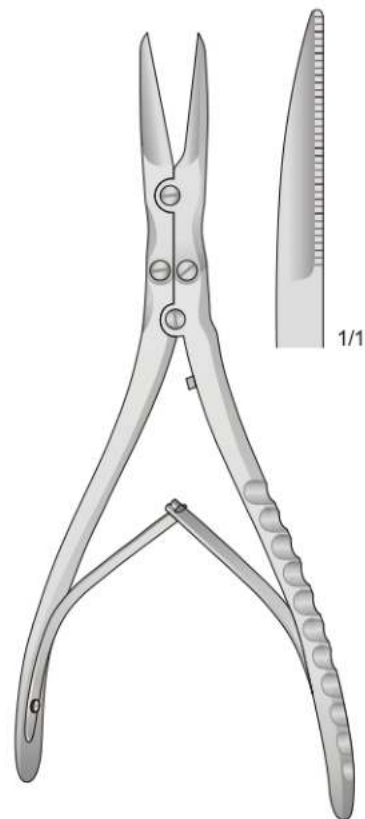
BÖHLER
ST-6661
150 mm



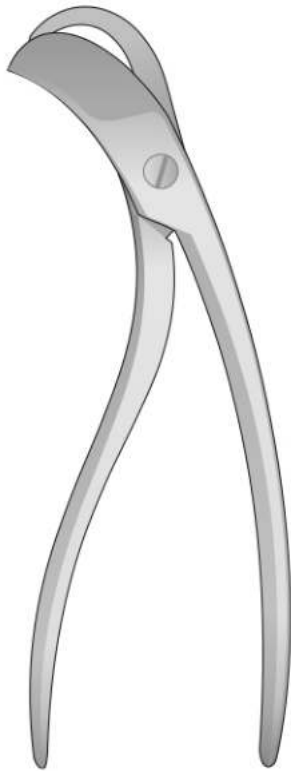
RUSKIN-LISTON
ST-6663
190 mm



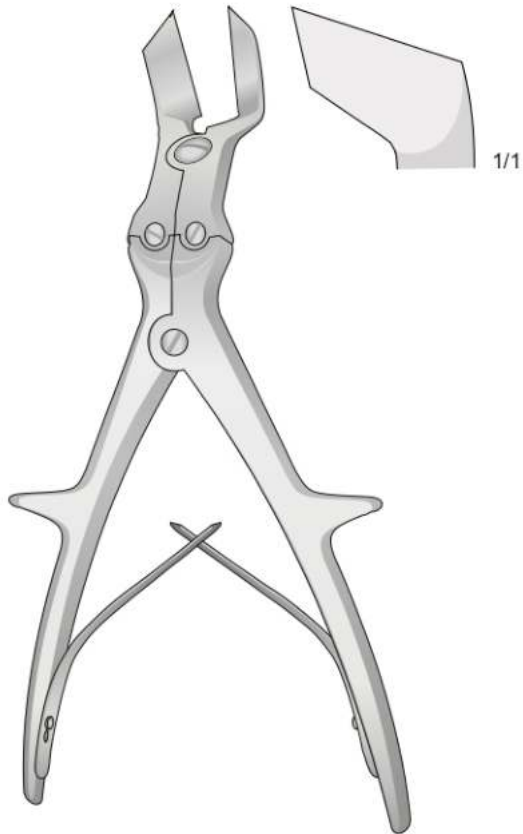
ST-6664
180 mm



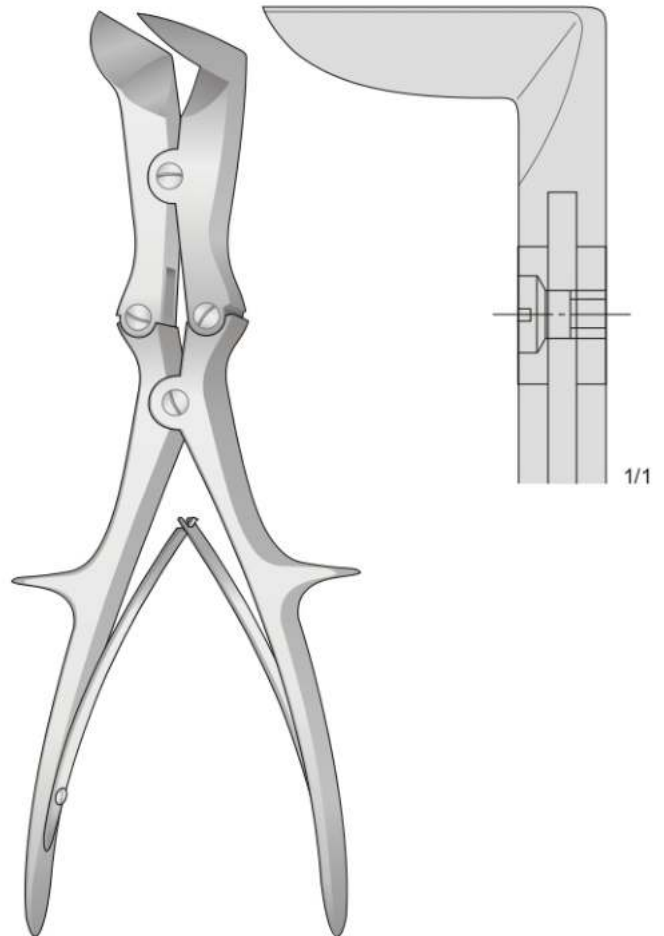
ST-6666
215 mm



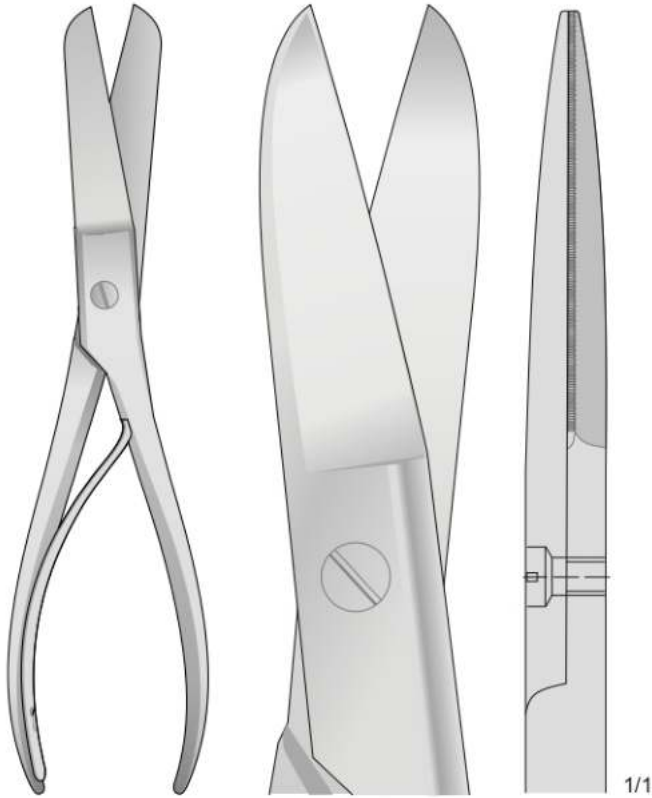
COLLIN
ST-6667
195 mm



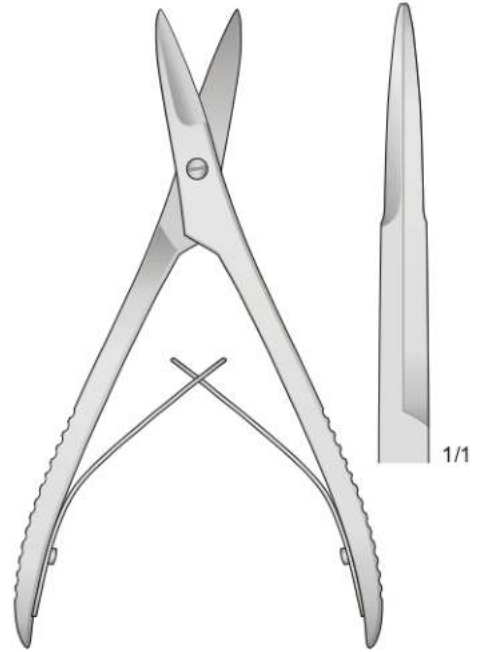
KEY-HORSLEY
ST-6668
235 mm



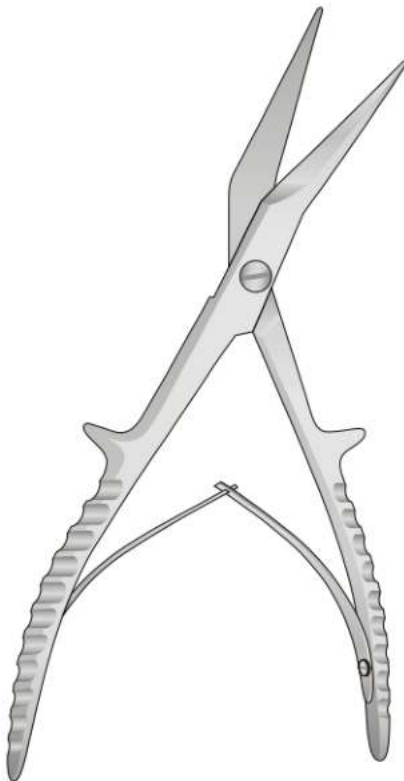
LISTON-STILLE
ST-6669
265 mm



ST-6670
230 mm



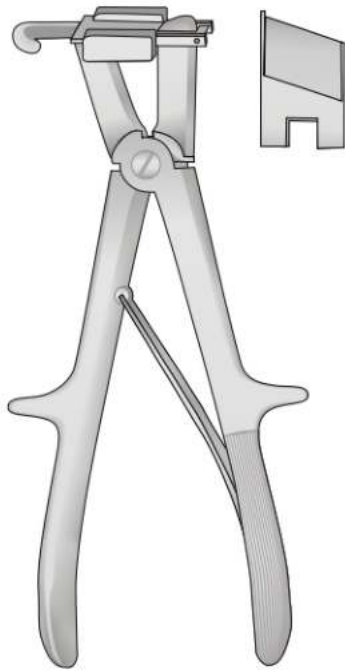
ST-6671
160 mm



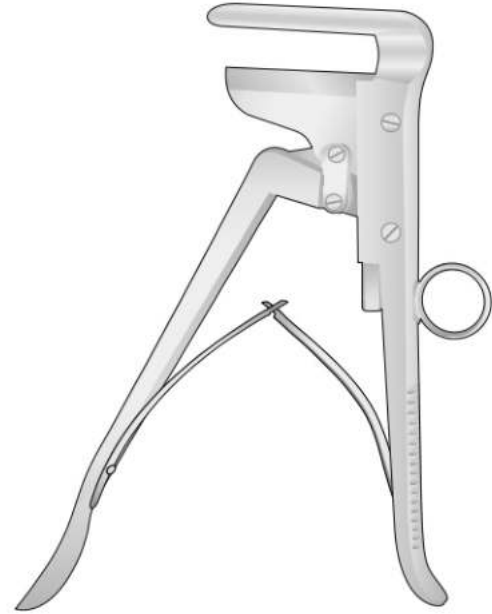
ST-6672
195 mm



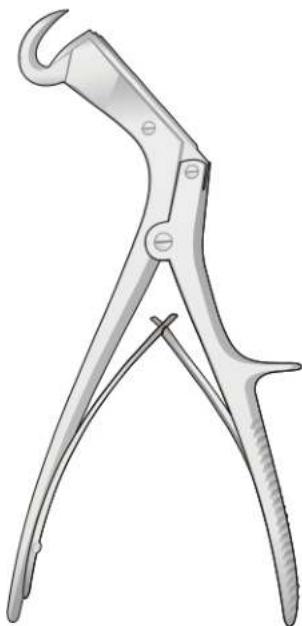
JACKSON-TESSIER
ST-6673
190 mm



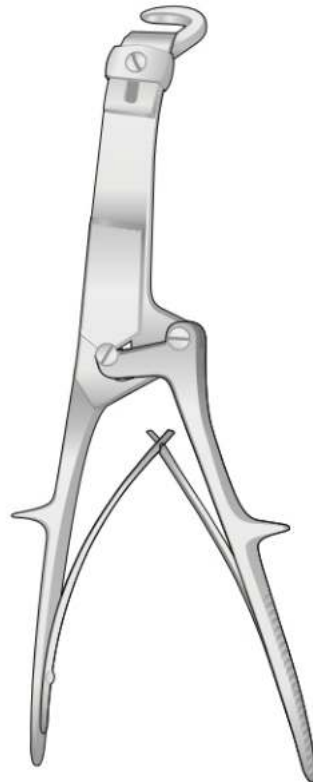
SAUERBRUCH
ST-6674 - 230 mm
ST-6675 - 260 mm



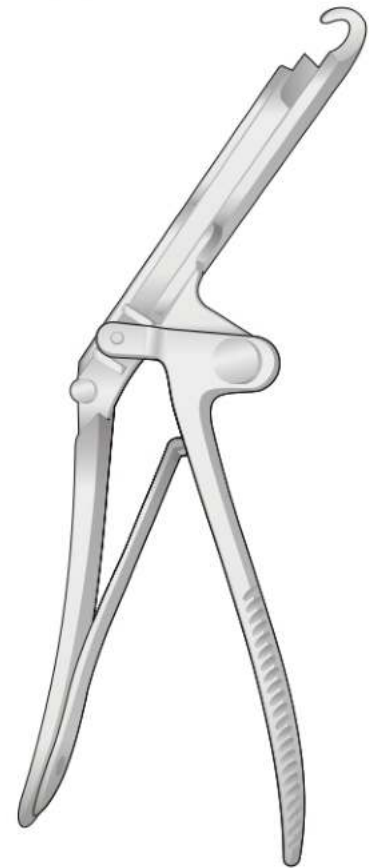
SCHUMACHER
ST-6676
210 mm



GIERTZ-STILLE
ST-6677
250 mm



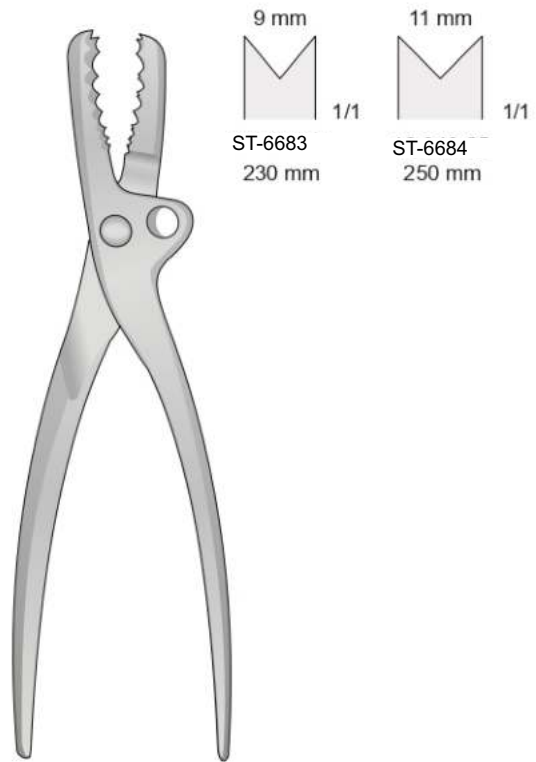
BRUNNER
ST-6678 - Destro
ST-6679 - Sinistro
320 mm



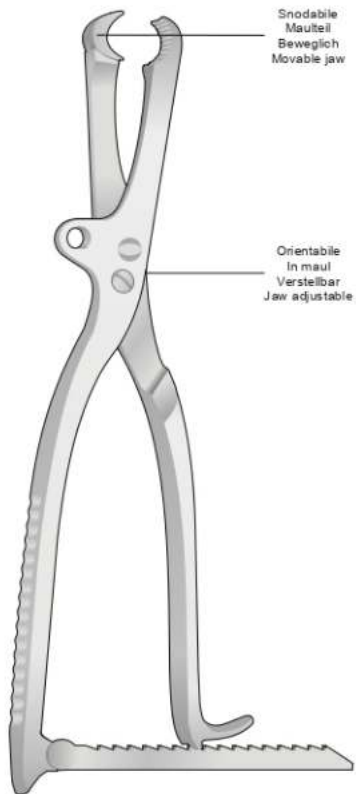
SAUERBRUCH-FREY
ST-6680
370 mm



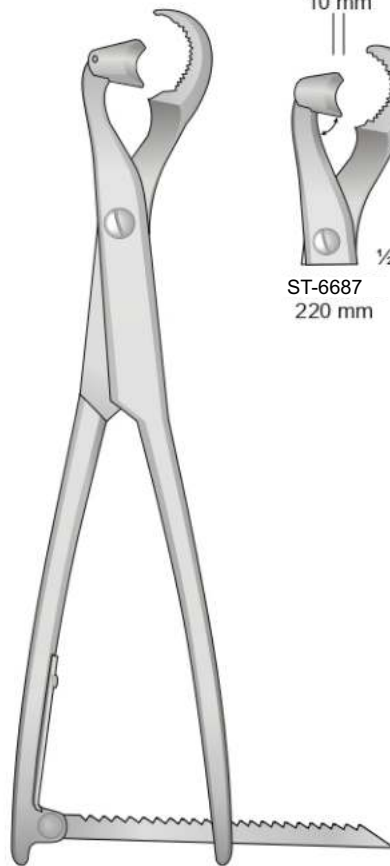
FARABEU-F-LAMBOTTE
ST-6681
250 mm



FARABEU
ST-6682



LAMBOTTE
ST-6685
265 mm



LAMBOTTE
ST-6686
330 mm



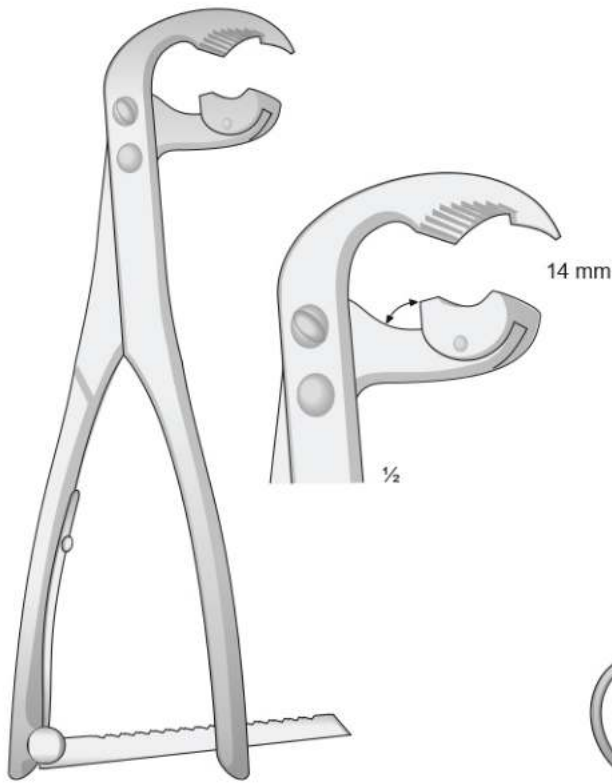
ST-6687
220 mm



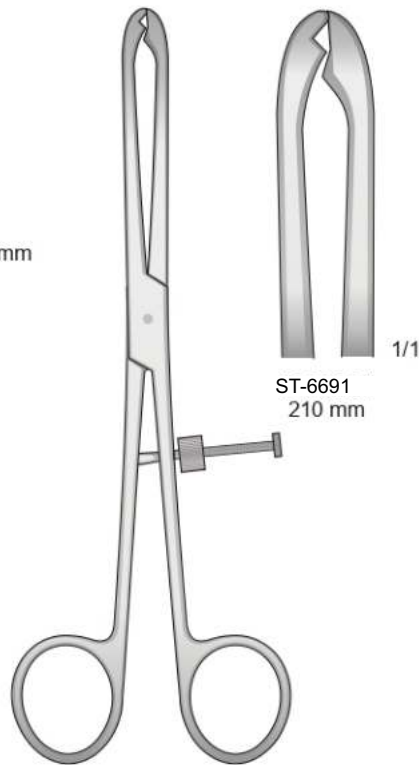
ST-6688
260 mm



ST-6689
330 mm



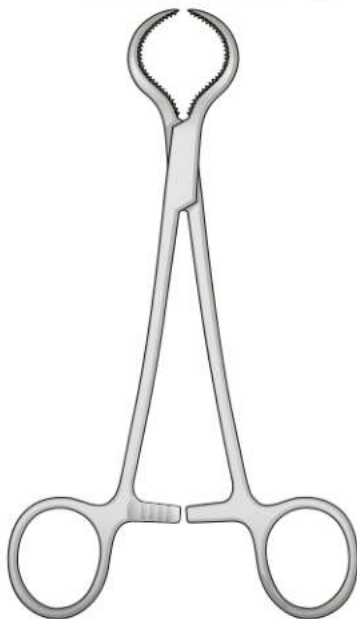
ST-6690
215 mm



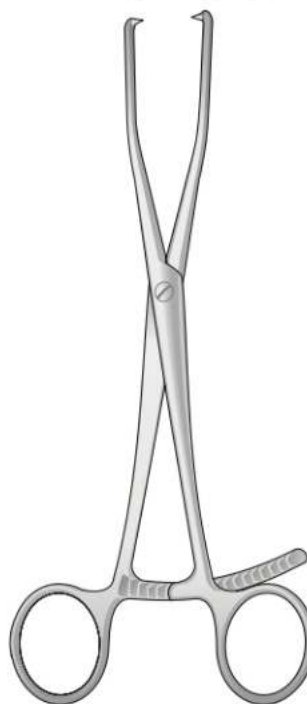
FIBULA
12-980
210 mm



ST-6692
210 mm



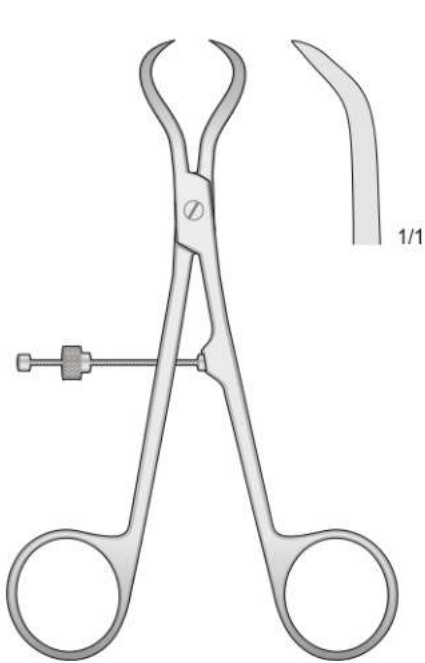
LEWIN
ST-6693
180 mm



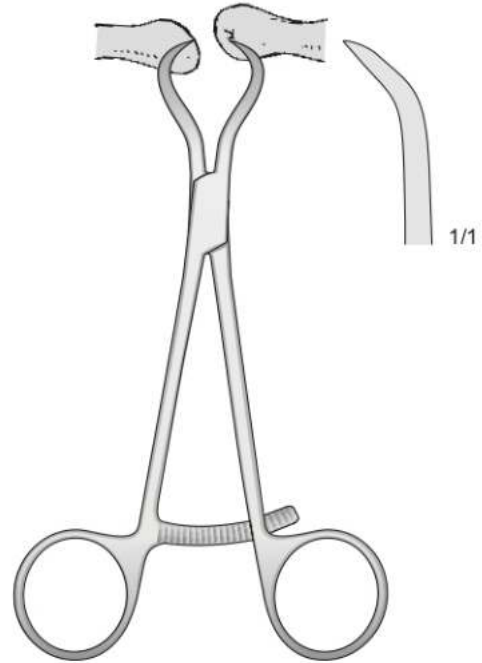
ST-6694
210 mm



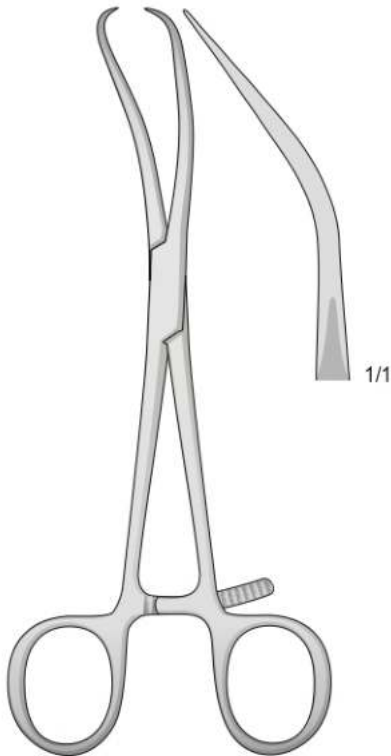
Pinze riposizionatrici di osso - Repositionszangen
Reposition forceps - Pinzas para la reducción de dedos



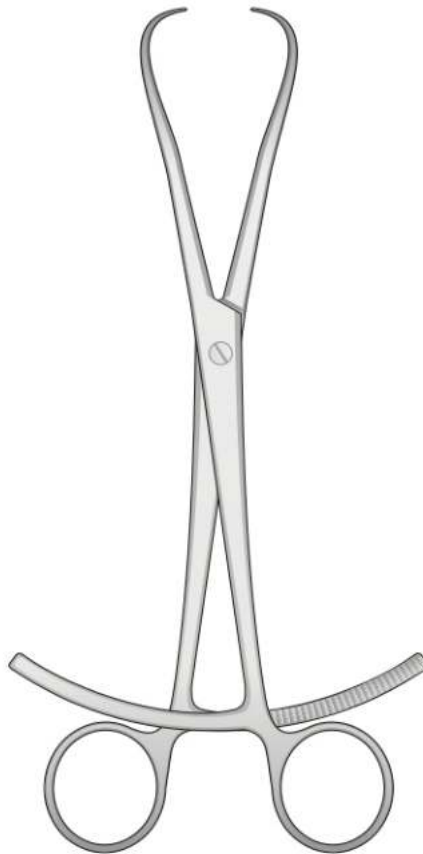
ST-6695
140 mm



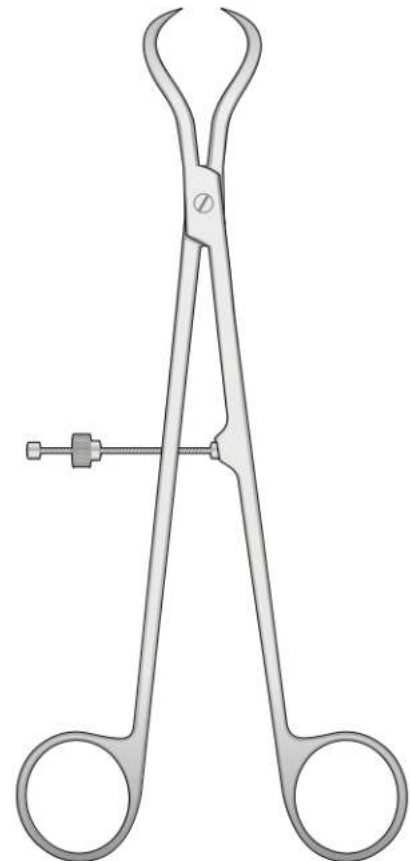
ST-6696
135 mm



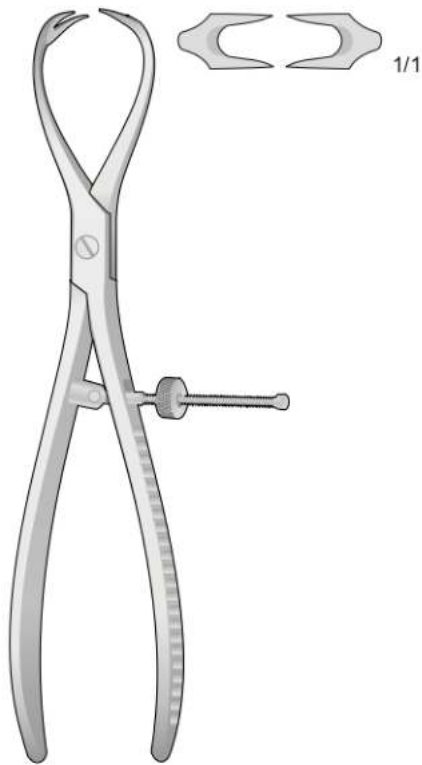
REILL
ST-6697
170 mm



ST-6698
200 mm



ST-6699
210 mm



PATELLA
ST-6700
185 mm

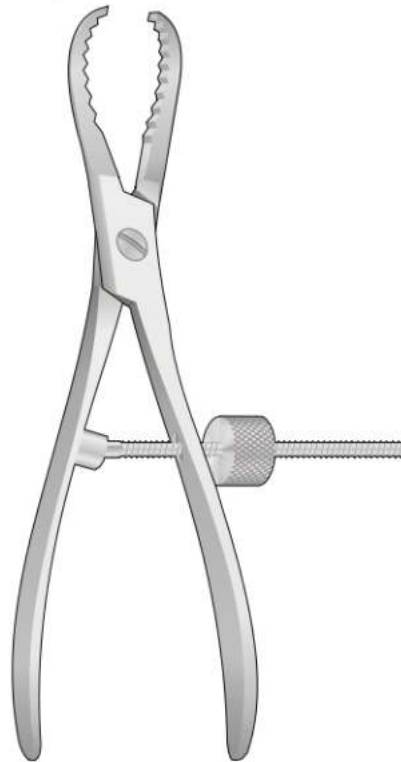
Pinza con regolazione
Forceps with thread fixation

Pinza con cremagliera
Forceps with ratchet fixation

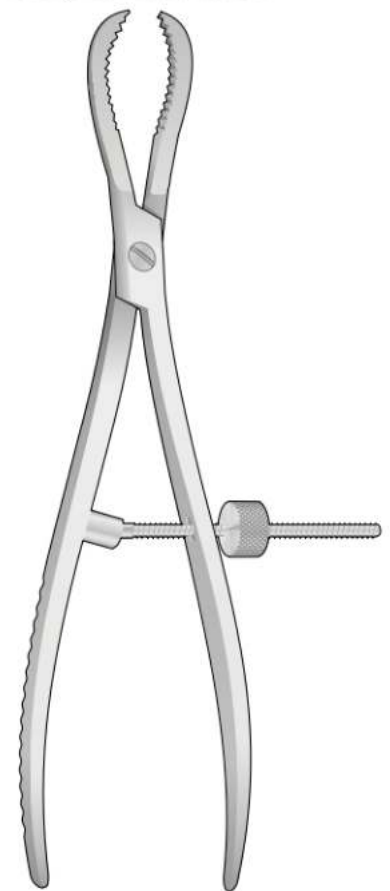
Pinza con regolazione
Forceps with thread fixation



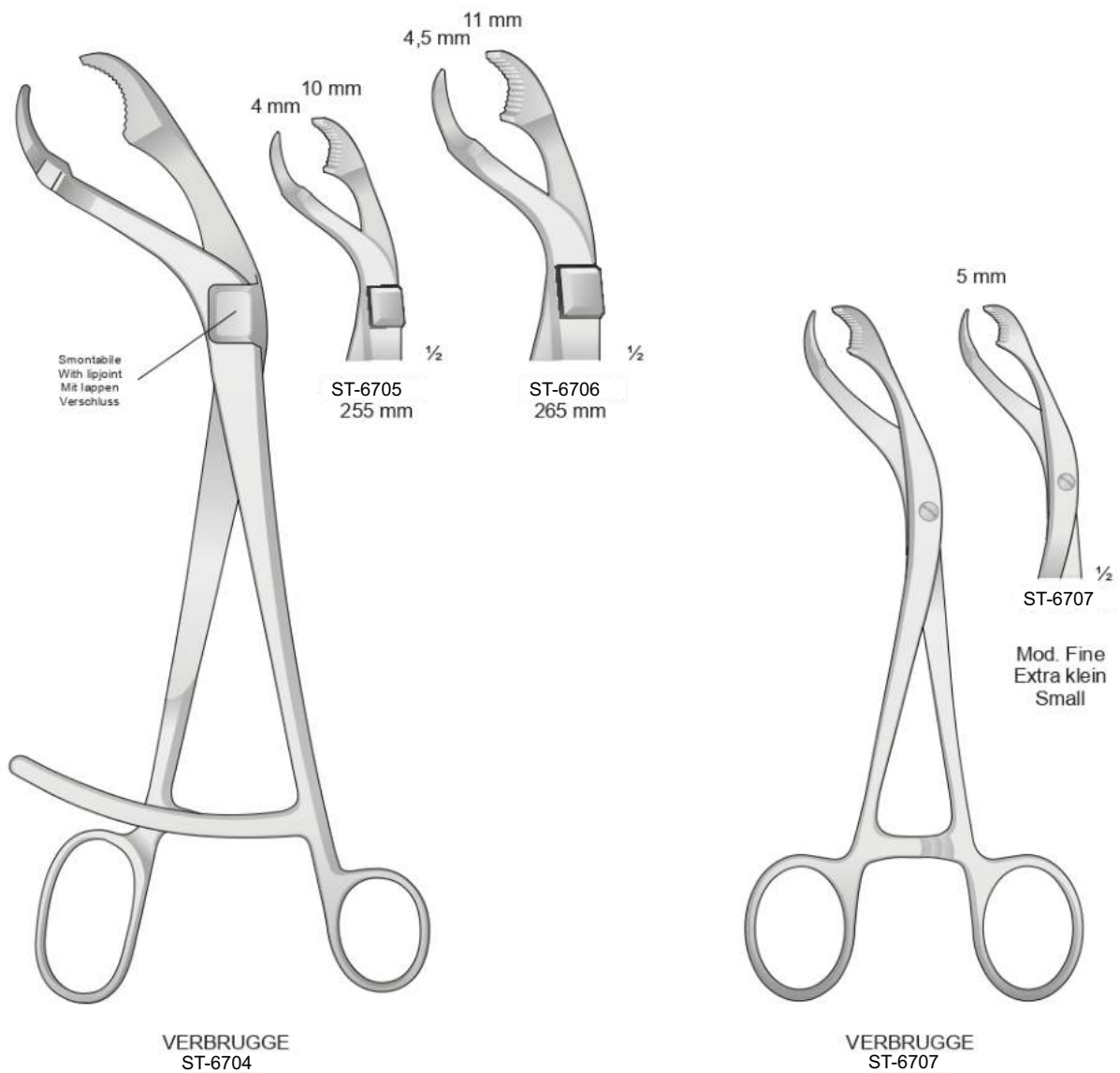
ST-6701
140 mm



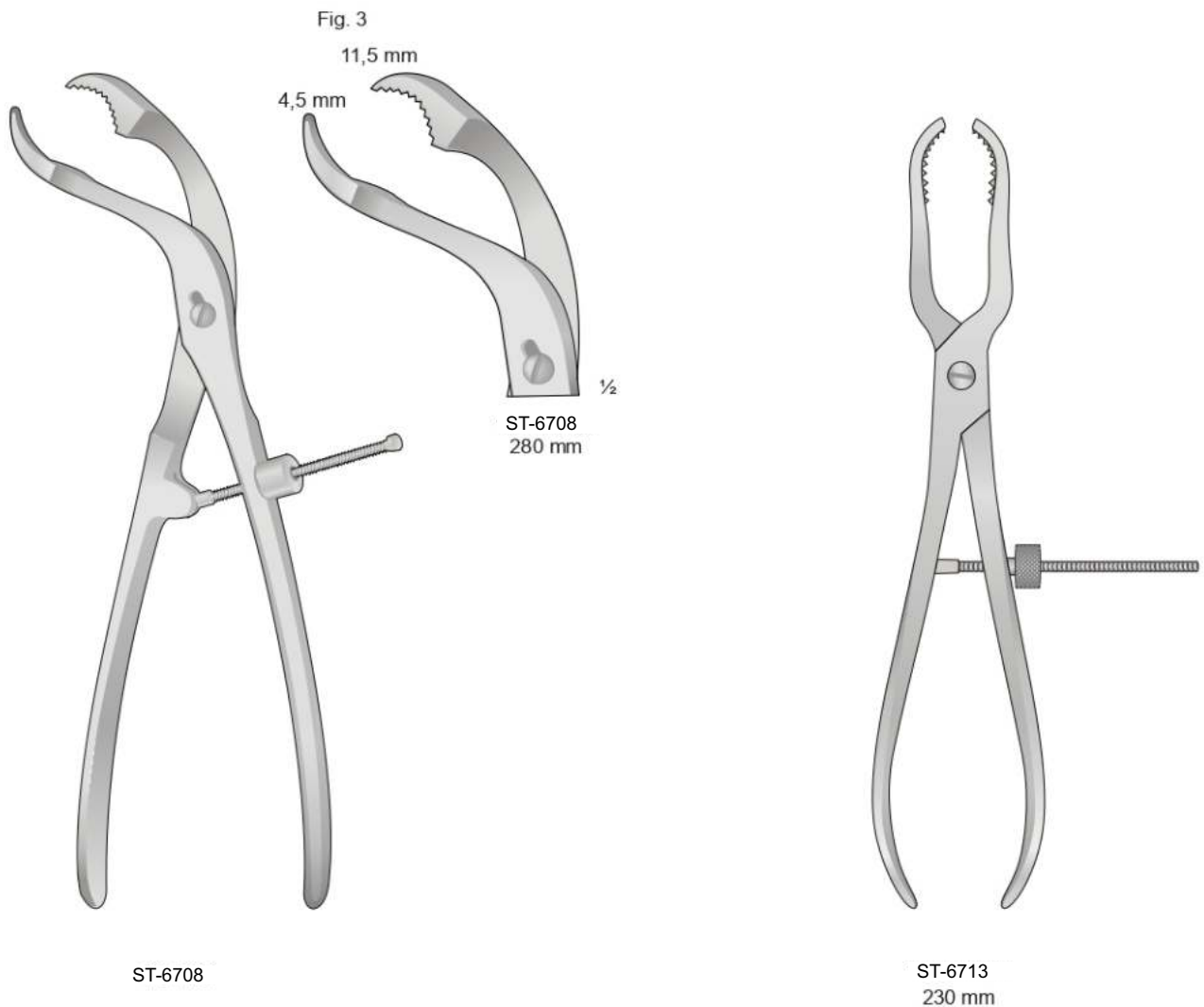
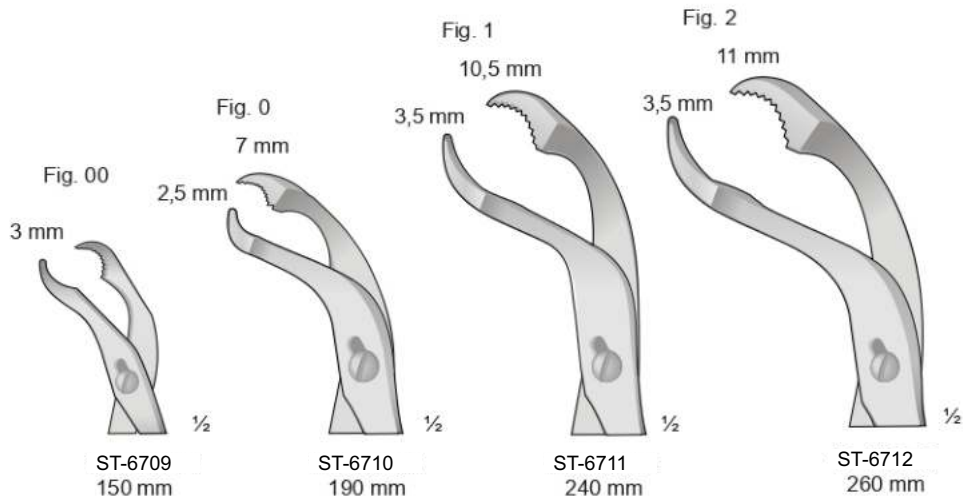
ST-6702
170 mm



ST-6703
235 mm



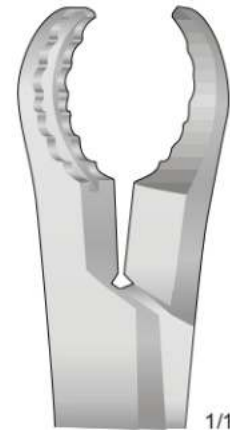
Autocentrante con blocco
Selbstzentrierend mit gewindesperre
Self-centering bone holding forceps with thread lock





ST-6715
230 mm

1/1



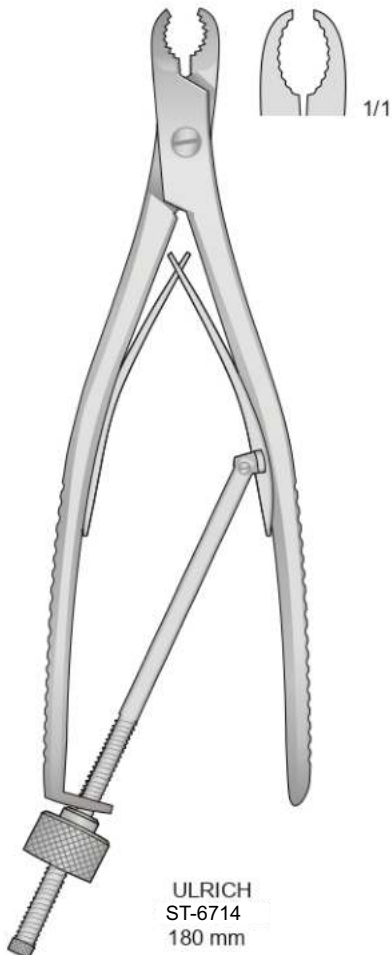
ST-6716
250 mm

1/1



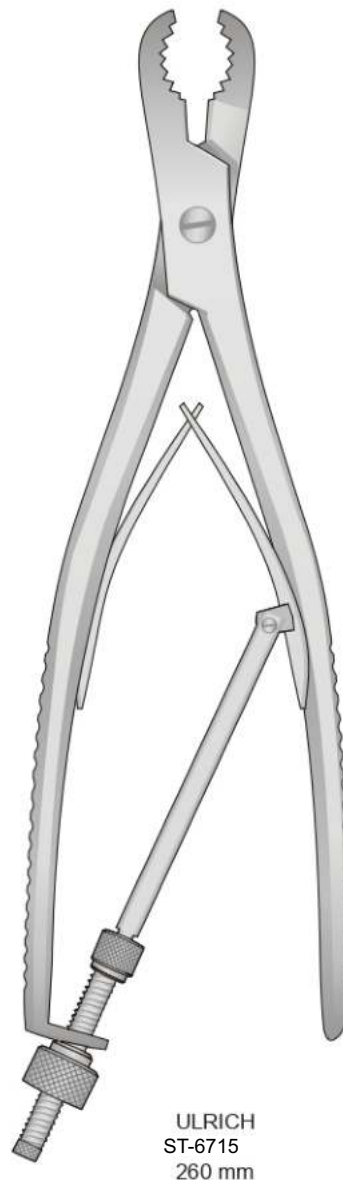
ST-6717
280 mm

1/1



ULRICH
ST-6714
180 mm

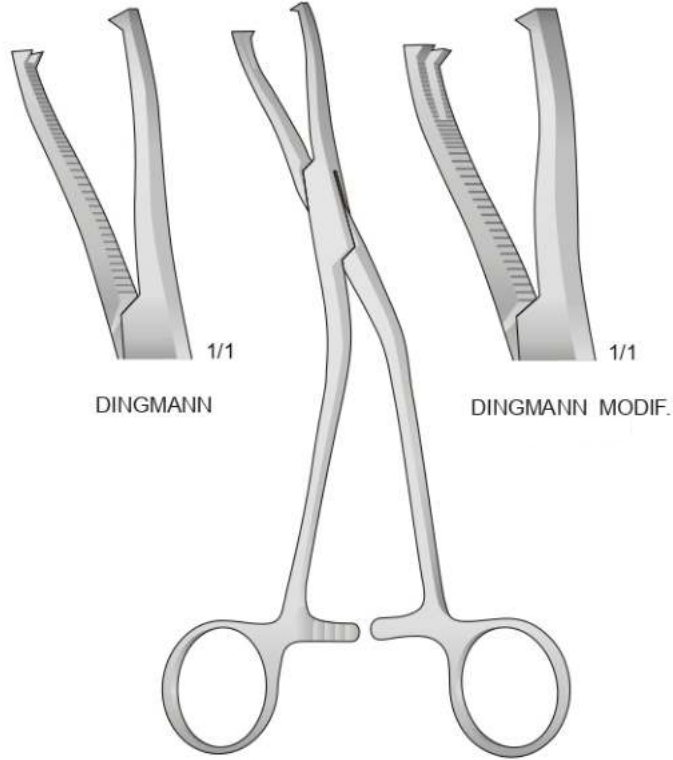
1/1



ULRICH
ST-6715
260 mm



Pinza per cartilagine



DINGMANN 1/1

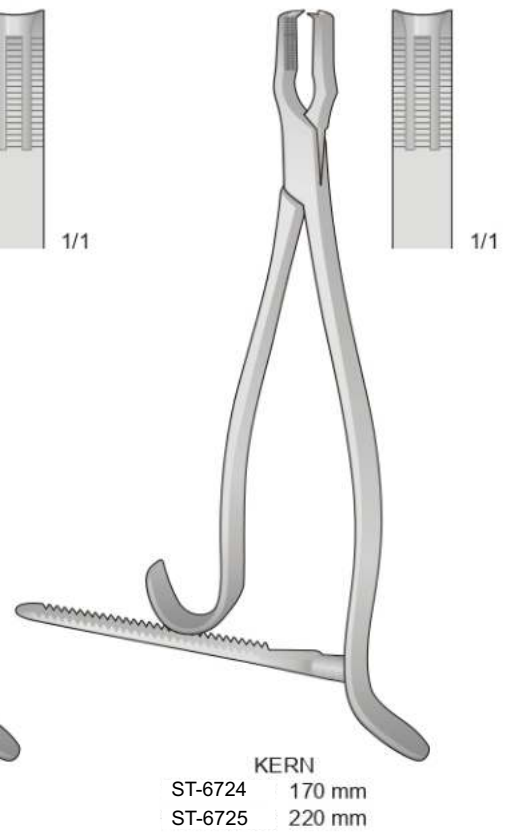
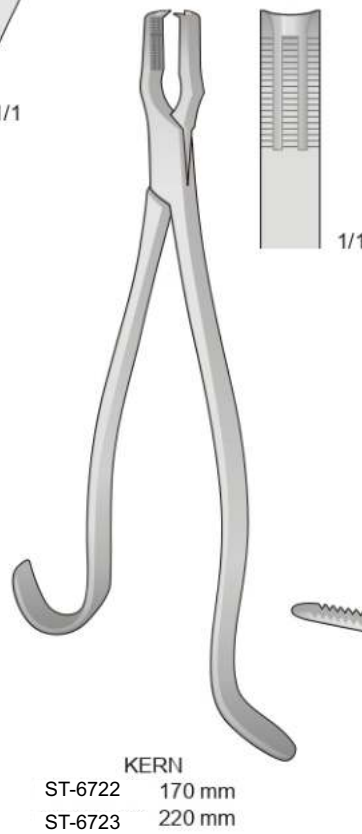
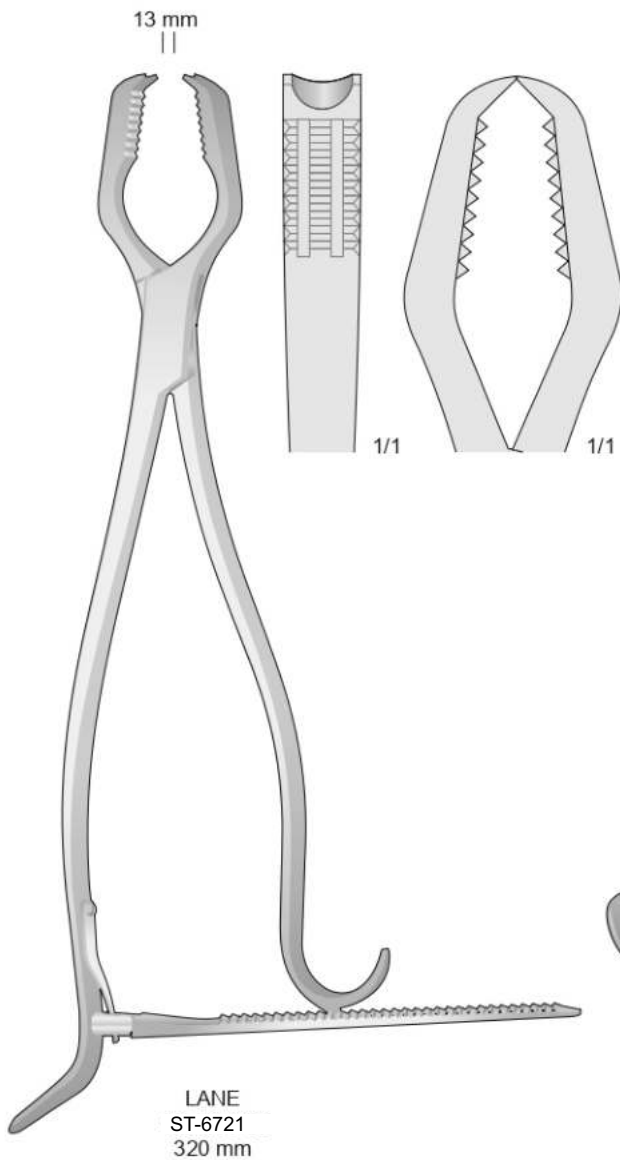
DINGMANN MODIF. 1/1

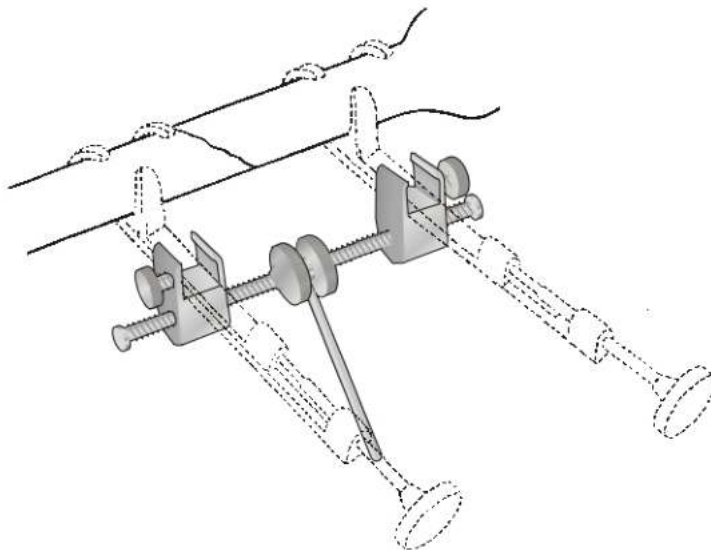
DINGMANN
12-1140
190 mm



ST-6719
185 mm

MARTIN
ST-6720
200 mm





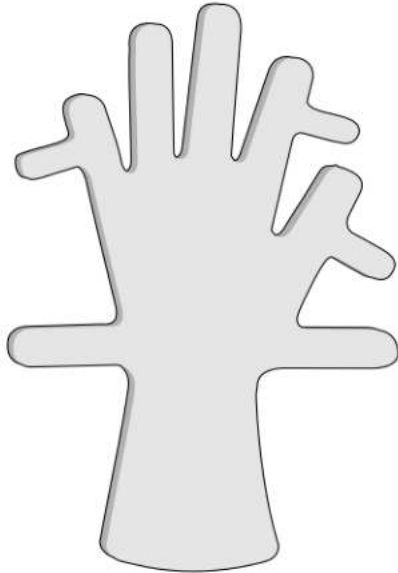
GERSTER
ST-6726



GERSTER-LOWMAN
ST-6727 120 mm
ST-6728 185 mm
ST-6729 200 mm

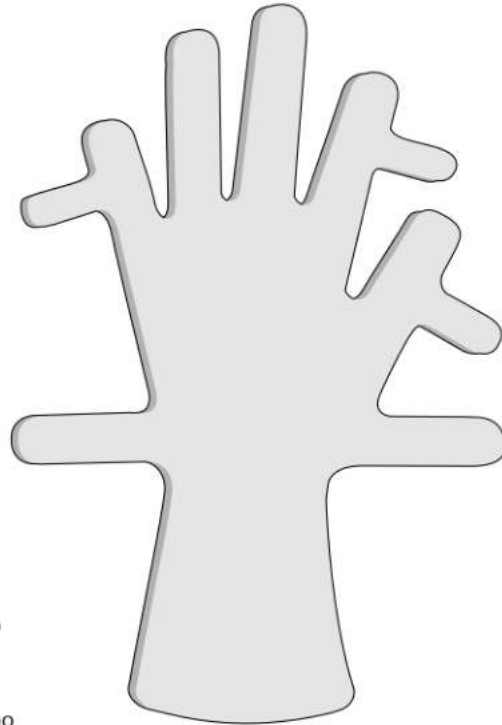


Per bambini
For children
Für kinder
Pour enfants
Para niños



ST-6730

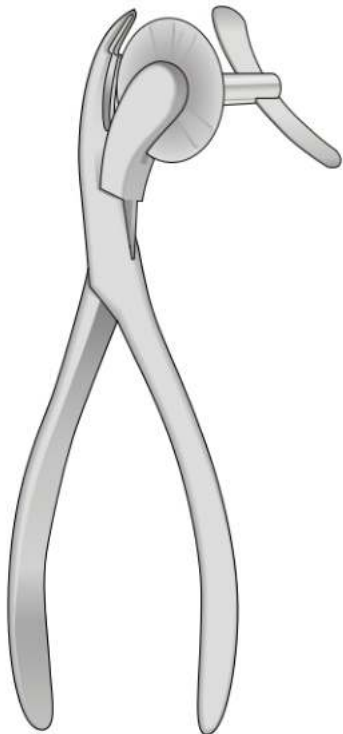
Per adulti - For adults - Für Erwachsene
Pour adultes - Para adultos



ST-6731

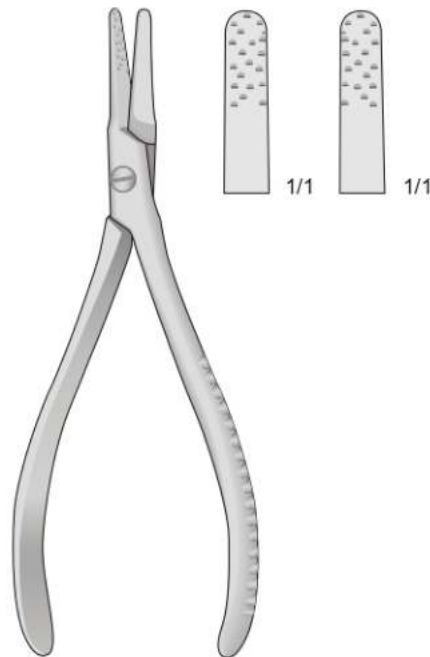
Mani di piombo
Lead hands
Bleihände
Main de plomb
Manos de plombo

Pinza taglia anelli - Forceps for opening rings
Fingerringssägen - Scies pour bagues - Sierra para anillos



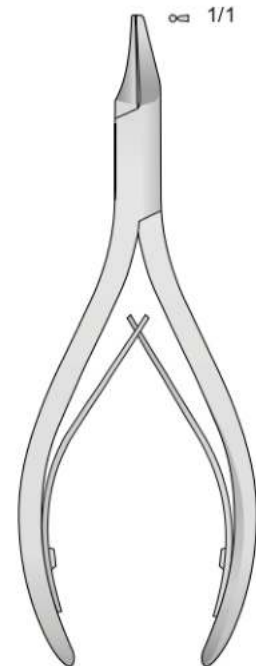
ST-6732
170 mm

Pinza per estrazione delle unghie
Nail extracting forceps
Nagelaus reisszange
Pince pour extraire les ongles
Pinzas para arrancar uñas



RADOLF
ST-6733
135 mm

Pinza per unghie
Nail nipper
Nagelspaltzange
Pince à ongles
Pinzas corta uñas



ST-6734
135 mm



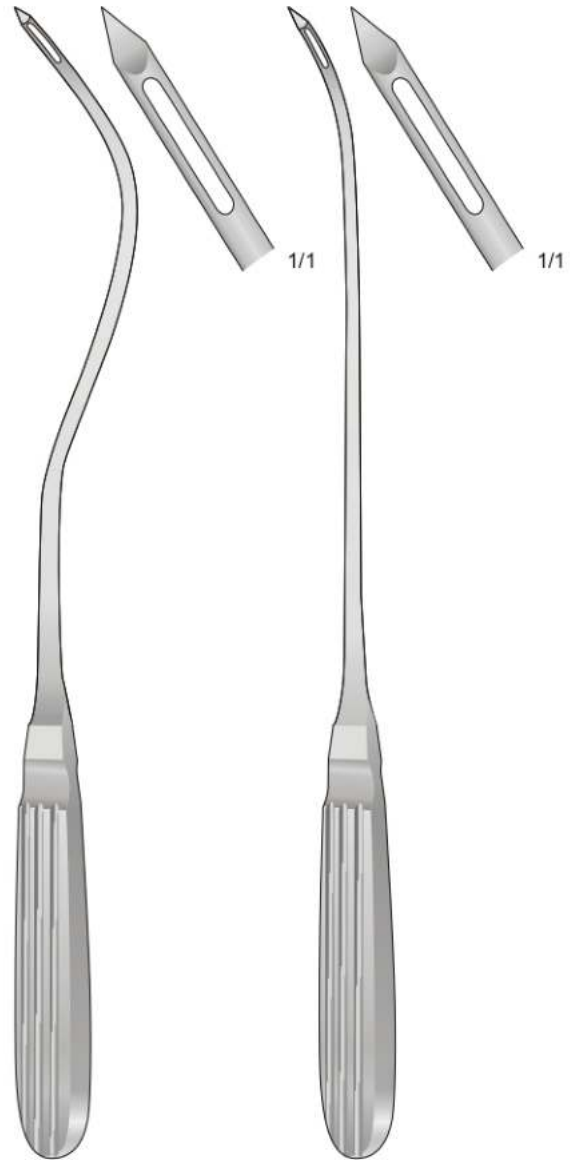
OBWEGESER
ST-6735
140 mm



OBWEGESER
ST-6736
230 mm

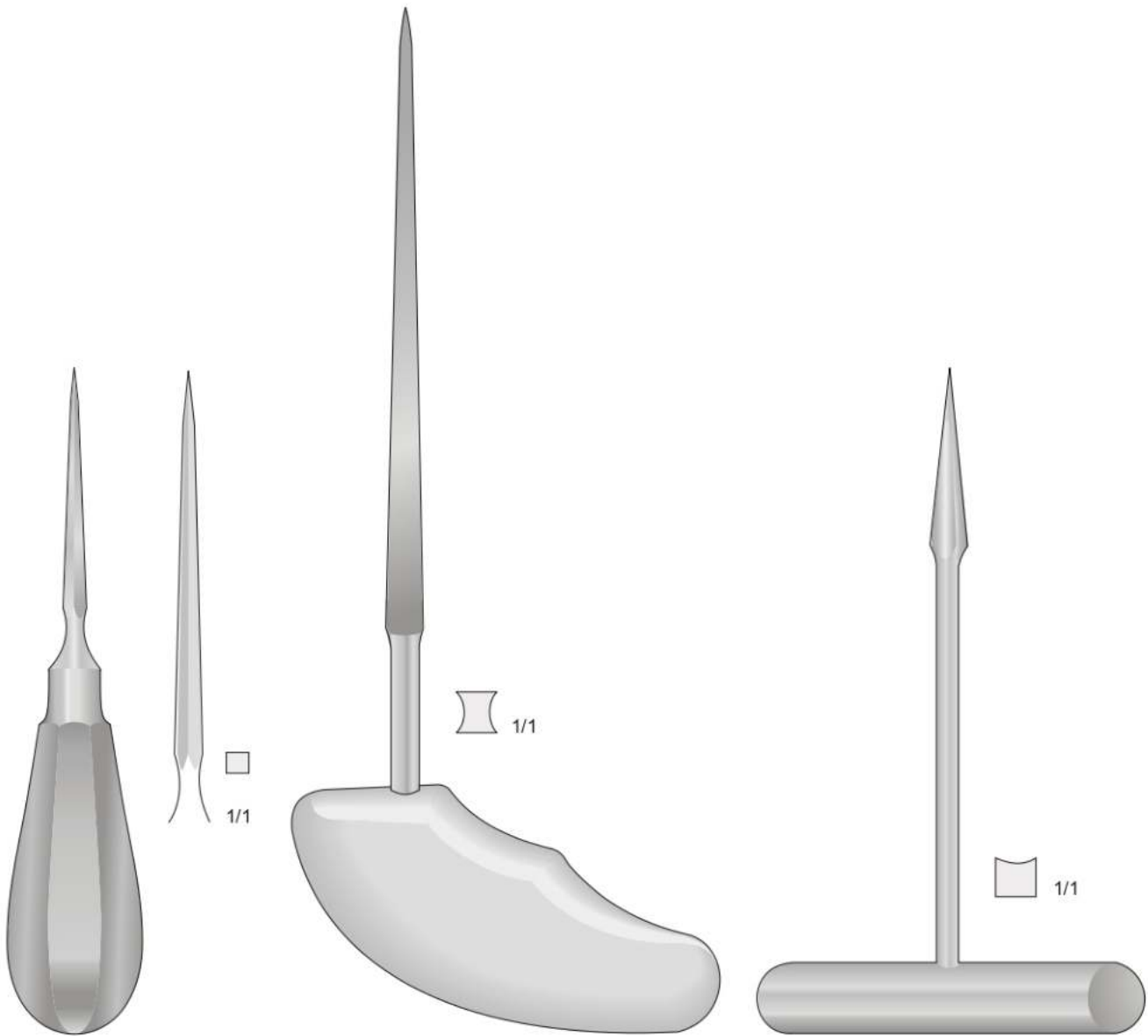


ST-6737
180 mm



SANDERS-BROWN
ST-6738
290 mm

SANDERS-BROWN
ST-6739
300 mm



ST-6740
140 mm

PERTHES
ST-6741
210 mm

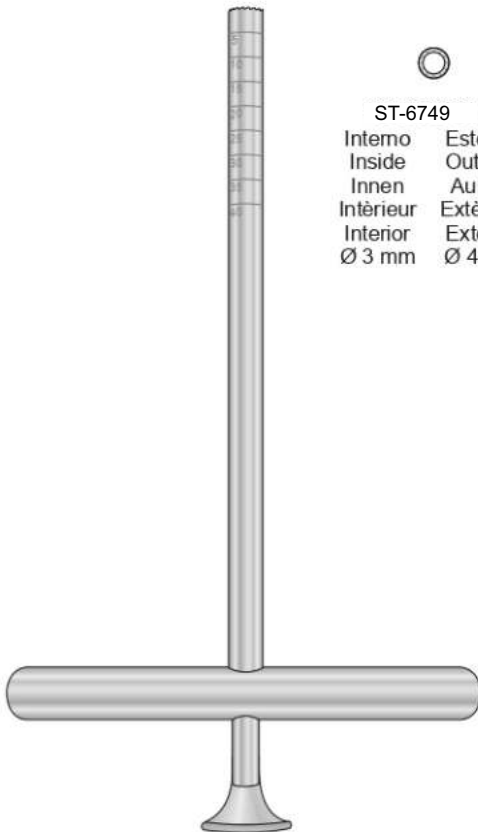
ST-6742
140 mm

Punche da biopsia - Hautstanzen
Dermal punches - Trépanos cutáneos



- 
 ST-6744
3 mm
- 
 ST-6745
4 mm
- 
 ST-6746
5 mm
- 
 ST-6747
6 mm

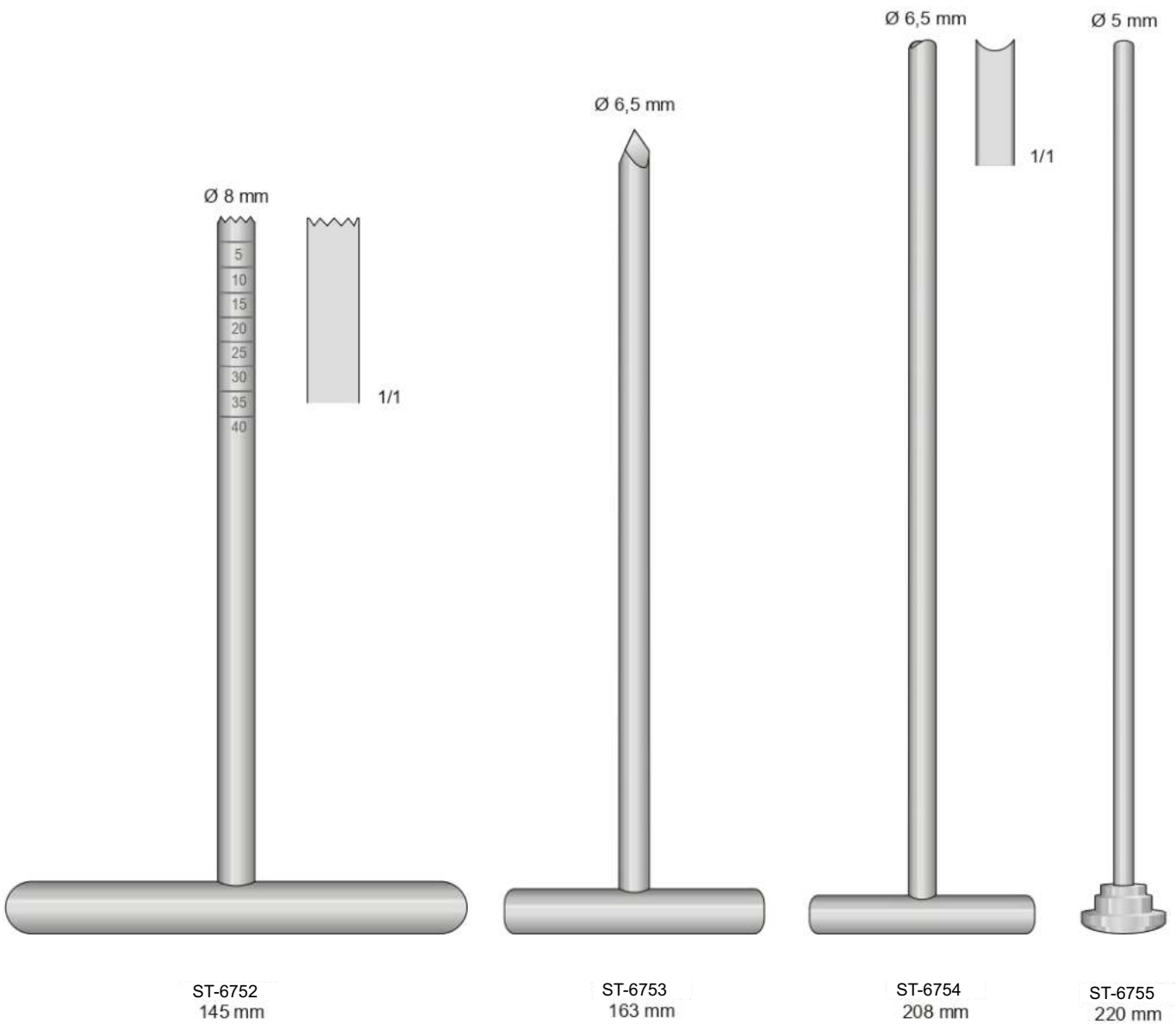
KEYES
ST-6743
100 mm



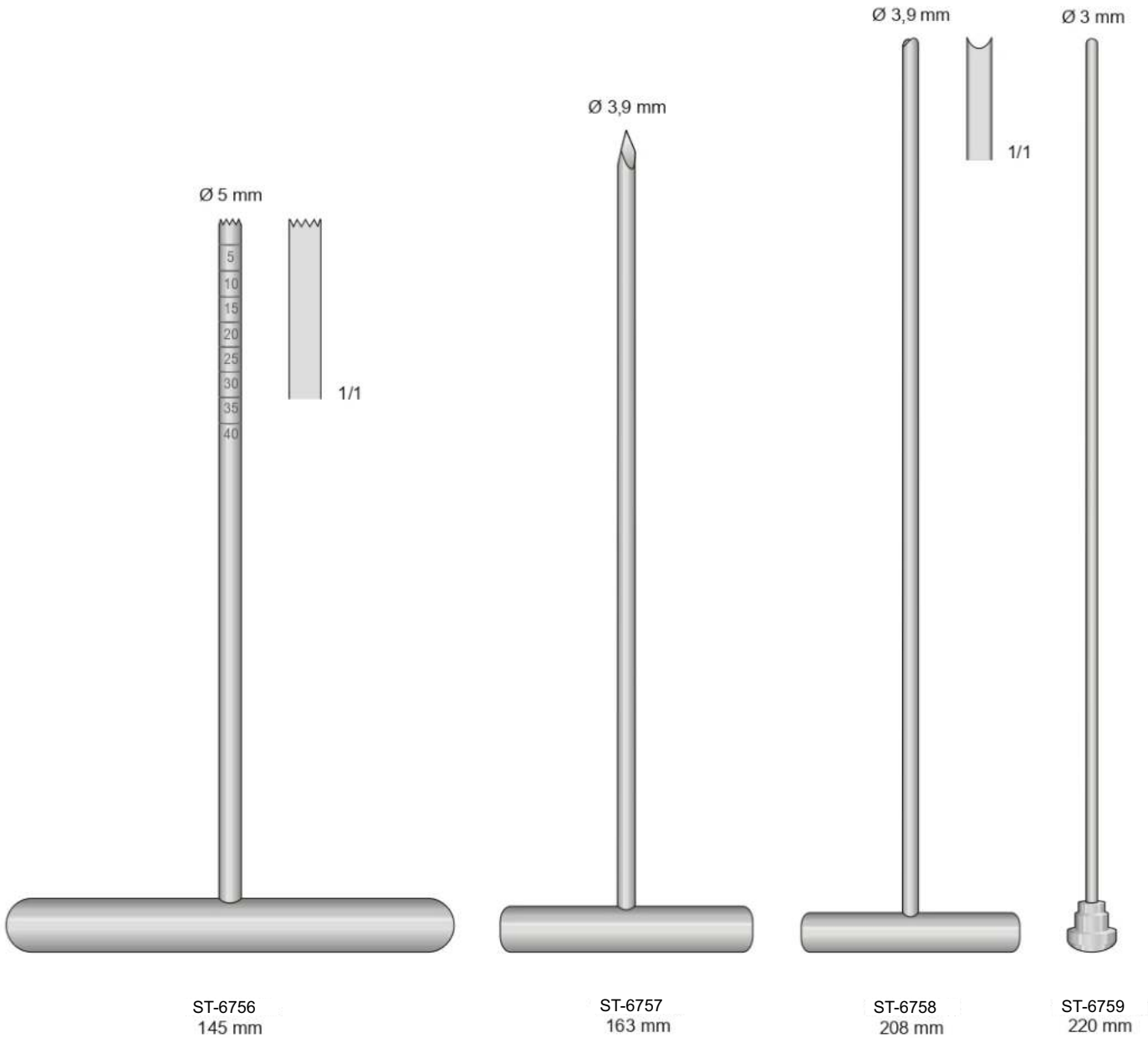
ST-6748
170 mm

- | | | | | | |
|---|-----------|---|-----------|---|-----------|
|  | |  | |  | |
| ST-6749 | | ST-6750 | | ST-6751 | |
| Interno | Esterno | Interno | Esterno | Interno | Esterno |
| Inside | Outside | Inside | Outside | Inside | Outside |
| Innen | Außen | Innen | Außen | Innen | Außen |
| Intérieur | Extérieur | Intérieur | Extérieur | Intérieur | Extérieur |
| Interior | Exterior | Interior | Exterior | Interior | Exterior |
| Ø 3 mm | Ø 4 mm | Ø 3,9 mm | Ø 5 mm | Ø 6,4 mm | Ø 8 mm |

12-1260-01
Set completo di 4 pezzi
Set complete with 4 pieces
Komplettset mit 4 Teilen
Set complet avec 4 pièces
Set completo con 4 piezas



Set completo di 4 pezzi
Set complete with 4 pieces
Kompletset mit 4 Teilen
Set complet avec 4 pièces
Set completo con 4 piezas





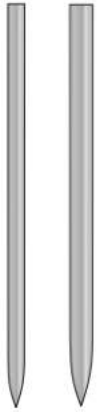
KIRSCHNER
Punta trequarti
Trocar point
Trokarspitze
Pointe de Trocart
Punta de tròcar



KIRSCHNER
Punta trequarti
Trocar point
Trokarspitze
Pointe de Trocart
Punta de tròcar

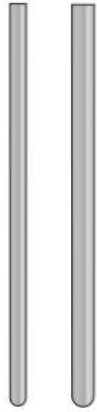


KIRSCHNER
Punte lanceolate
Lance point
Lanzenspitze
Pointe lancette
Punta lanceolar



Punta trequarti
Trocar point
Trokarspitze
Pointe de Trocart
Punta de tròcar

310 mm



Punta rotonda
Round shaft
Rundes ende
Pointe ronde
Punta redonda

310 mm



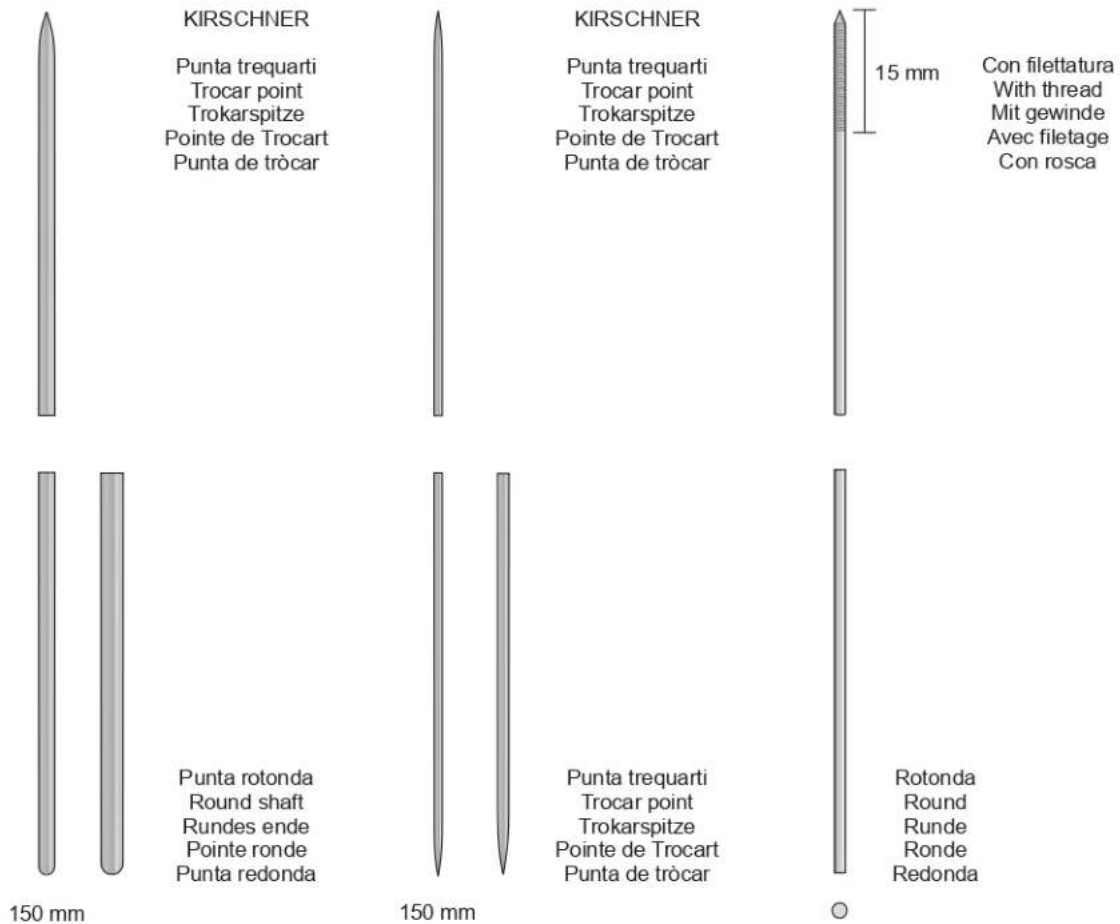
Punte lanceolate
Lance point
Lanzenspitze
Pointe lancette
Punta lanceolar

310 mm

Ø/Diam.	Conf. 10 pz.
0,8 mm	ST-6760-1
1,0 mm	ST-6760-2
1,2 mm	ST-6760-3
1,4 mm	ST-6760-4
1,5 mm	ST-6760-5
1,6 mm	ST-6760-6
1,7 mm	ST-6760-7
1,8 mm	ST-6760-8
2,0 mm	ST-6760-9
2,2 mm	ST-6760-10
2,5 mm	ST-6760-11
3,0 mm	ST-6760-12

Ø/Diam.	Conf. 10 pz.
0,8 mm	ST-6761-1
1,0 mm	ST-6761-2
1,2 mm	ST-6761-3
1,4 mm	ST-6761-4
1,5 mm	ST-6761-5
1,6 mm	ST-6761-6
1,7 mm	ST-6761-7
1,8 mm	ST-6761-8
2,0 mm	ST-6761-9
2,2 mm	ST-6761-10
2,5 mm	ST-6761-11
3,0 mm	ST-6761-12

Ø/Diam.	Conf. 10 pz.
0,8 mm	ST-6762-1
1,0 mm	ST-6762-2
1,2 mm	ST-6762-3
1,5 mm	ST-6762-4
1,6 mm	ST-6762-5
1,8 mm	ST-6762-6
2,0 mm	ST-6762-7
2,2 mm	ST-6762-8
2,5 mm	ST-6762-9
3,0 mm	ST-6762-10



Ø/Diam.	Conf. 10 pz.
0,8 mm	ST-6763-1
1,0 mm	ST-6763-2
1,2 mm	ST-6763-3
1,4 mm	ST-6763-4
1,5 mm	ST-6763-5
1,6 mm	ST-6763-6
1,7 mm	ST-6763-7
1,8 mm	ST-6763-8
2,0 mm	ST-6763-9
2,2 mm	ST-6763-10
2,5 mm	ST-6763-11
3,0 mm	ST-6763-12

Ø/Diam.	Conf. 10 pz.
0,8 mm	ST-6764-1
1,0 mm	ST-6764-2
1,2 mm	ST-6764-3
1,4 mm	ST-6764-4
1,6 mm	ST-6764-5

KIRSCHNER			
Codice	Ø mm	Lung.	Lung. filo
ST-6765-1	1,5	150	5
ST-6765-1	1,6	150	15
ST-6765-1	2	150	15
ST-6765-1	2	200	15

KIRSCHNER

Bundel-Nagel



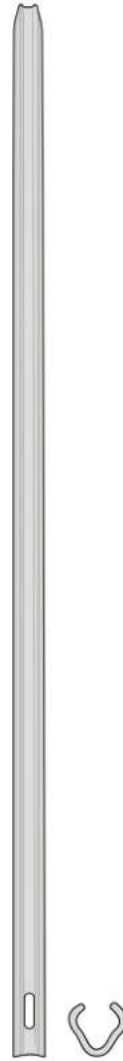
500 mm

Steinmann pins



310 mm

Küntscher



400 mm

Threaded Steinmann Pins



230 mm

Runde

Ø/Diam.	Conf. 10 pz.
2,0 mm	ST-6766-1
2,5 mm	ST-6766-2
3,0 mm	ST-6766-3
3,5 mm	ST-6766-4
4,0 mm	ST-6766-5
4,5 mm	ST-6766-6
5,0 mm	ST-6766-7
5,5 mm	ST-6766-8
6,0 mm	ST-6766-9

Ø/Diam.	Conf. 1 pz.
3,5 mm	ST-6767-1
4,0 mm	ST-6767-2
4,5 mm	ST-6767-3
5,0 mm	ST-6767-4
6,0 mm	ST-6767-5
6,5 mm	ST-6767-6

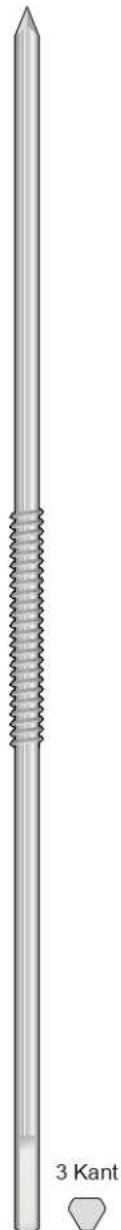
Ø/Diam.	Conf. 1 pz.
6,0 mm	ST-6768-1
7,0 mm	ST-6768-2
8,0 mm	ST-6768-3
9,0 mm	ST-6768-4
10 mm	ST-6768-5
11 mm	ST-6768-6
12 mm	ST-6768-7

Ø/Diam.	Conf. 1 pz.
2,0 mm	ST-6769-1
2,5 mm	ST-6769-2

Steinmann Pins with Central Thread with Trocar Point

Contenitore per sterilizzazione Kirschner
Bohrdrahtspender

Positivo
Thread - Ø is 0,5 mm
more than pin - Ø



STEINMANN PINS			
Codice	Ø mm	Lung.	Lung. Filo mm
ST-6770-1	3	150	37
ST-6770-2	3	180	48
ST-6770-3	3	200	50
ST-6770-4	3	230	52
ST-6770-5	3,5	150	37
ST-6770-6	3,5	180	52
ST-6770-7	3,5	200	52
ST-6770-8	3,5	230	52
ST-6770-9	4	150	37
ST-6770-10	4	180	52
ST-6770-11	4	200	50
ST-6770-12	4	230	52
ST-6770-13	4	250	52
ST-6770-14	4,5	150	37
ST-6770-15	4,5	180	52
ST-6770-16	4,5	200	52
ST-6770-17	4,5	230	52
ST-6770-18	4,5	250	52
ST-6770-19	4,5	300	52
ST-6770-20	5	150	37
ST-6770-21	5	180	52
ST-6770-22	5	200	50
ST-6770-23	5	230	52
ST-6770-24	5	250	52
ST-6770-25	5	300	52

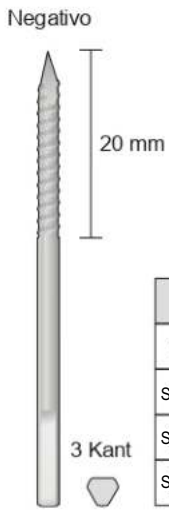
Ø 10 mm



ST-6770

ST-6771-1 - 320 mm
ST-6771-2 - 185 mm

Viti di Schanz
Schanz screws
Schanz'sche Schrauben
Vis de Schanz



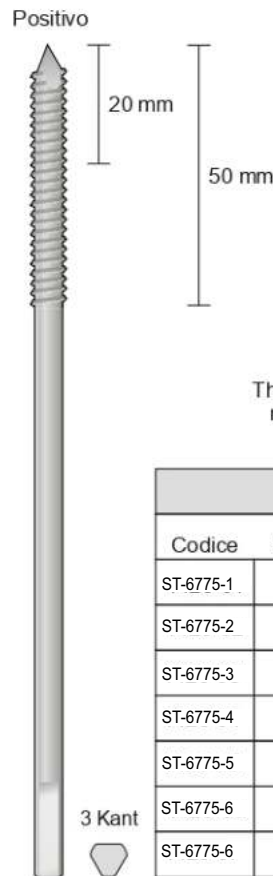
SCHANZ			
Codice	Ø mm	Lung.	Lung. filo
ST-6772-1	3	60	20
ST-6772-2	3	80	20
ST-6772-3	4	60	25



SCHANZ			
Codice	Ø mm	Lung.	Lung. filo
ST-6773-1	2	150	50
ST-6773-2	3	150	50
ST-6773-3	3,5	150	50
ST-6773-4	4	150	50
ST-6773-5	4,5	150	50
ST-6773-6	5	150	50



SCHANZ			
Codice	Ø mm	Lung.	Lung. filo
ST-6774-1	2	150	50
ST-6774-2	3	150	50
ST-6774-3	3,5	150	50
ST-6774-4	4	150	50
ST-6774-5	4,5	150	50
ST-6774-6	5	150	50



Thread - Ø is 0,5 mm more than pin - Ø

SCHANZ			
Codice	Ø mm	Lung.	Lung. filo
ST-6775-1	2	150	20
ST-6775-2	3	150	20
ST-6775-3	3,5	150	50
ST-6775-4	4	150	25
ST-6775-5	4	150	50
ST-6775-6	4,5	150	50
ST-6775-6	5	150	50

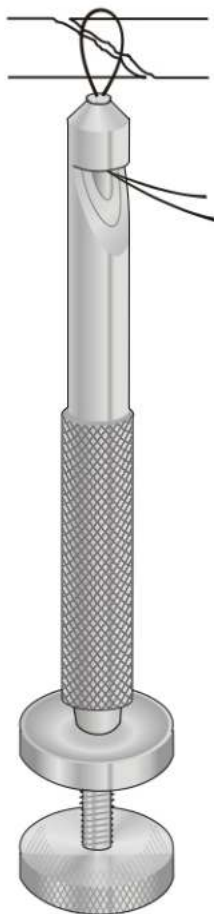
Strumenti per filo di cerchiaggio
Wire instrument set
Drahtinstrumentarium
Instruments à fil
Instrumental para cerclaje

Filo malleabile
per compattare l'osso
Wire soft
Draht weich
Fil à os
Alambre ligadura



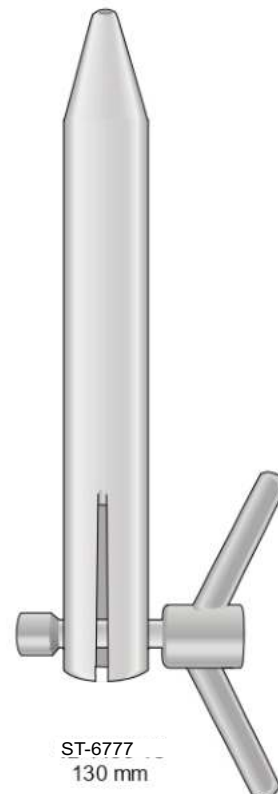
10 mt.

Ø/Diam.	Codice
0,2 mm	ST-6776-1
0,3 mm	ST-6776-2
0,4 mm	ST-6776-3
0,5 mm	ST-6776-4
0,6 mm	ST-6776-5
0,7 mm	ST-6776-6
0,8 mm	ST-6776-7
0,9 mm	ST-6776-8
1,0 mm	ST-6776-9
1,2 mm	ST-6776-10
1,5 mm	ST-6776-11



LOUTE
ST-6776
220 mm

Strumenti tendifili
Bone wire tighteners
Drahtspanninstrument
Tendeur serre fils
Tensor cierra-hilos



ST-6777
130 mm

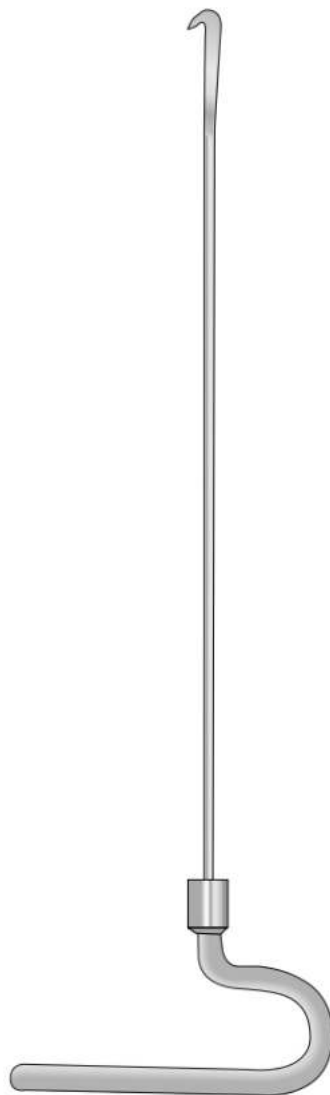


Fino a Ø 3 mm
Bis Ø 3 mm
Up to Ø 3 mm

Gancio d'estrazione
Extraction hooks
Extraktions haken
Crochets d'extraction
Ganchos extractores



WAGNER
12-1460-30
300 mm



ST-6779 - 290 mm
ST-6780 - 370 mm
ST-6781 - 420 mm



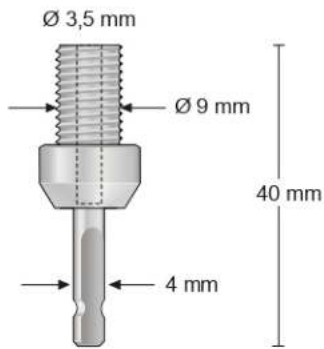
ST-6782
120 mm



KÜNTSCHNER
ST-6783
210 mm

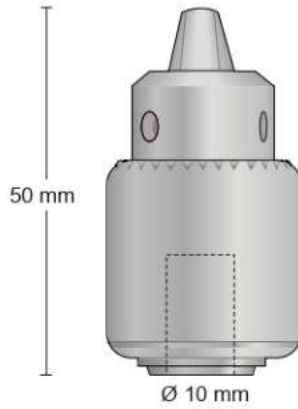
ST-6784
Completo con - Complete with
Komplett mit - Completes avec
Completo con:
1 LS-236
1 LS-229
1 LS-241

Attacco AO

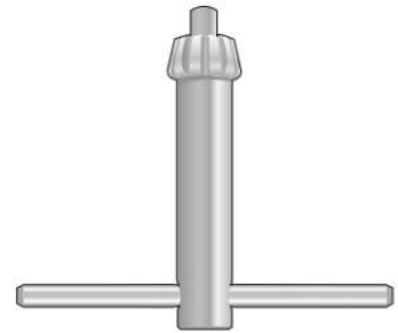


ST-6784-1
40 mm

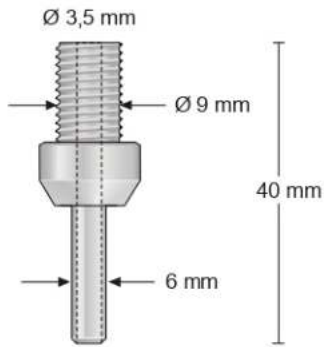
Inox
ORIGINAL JACOBS



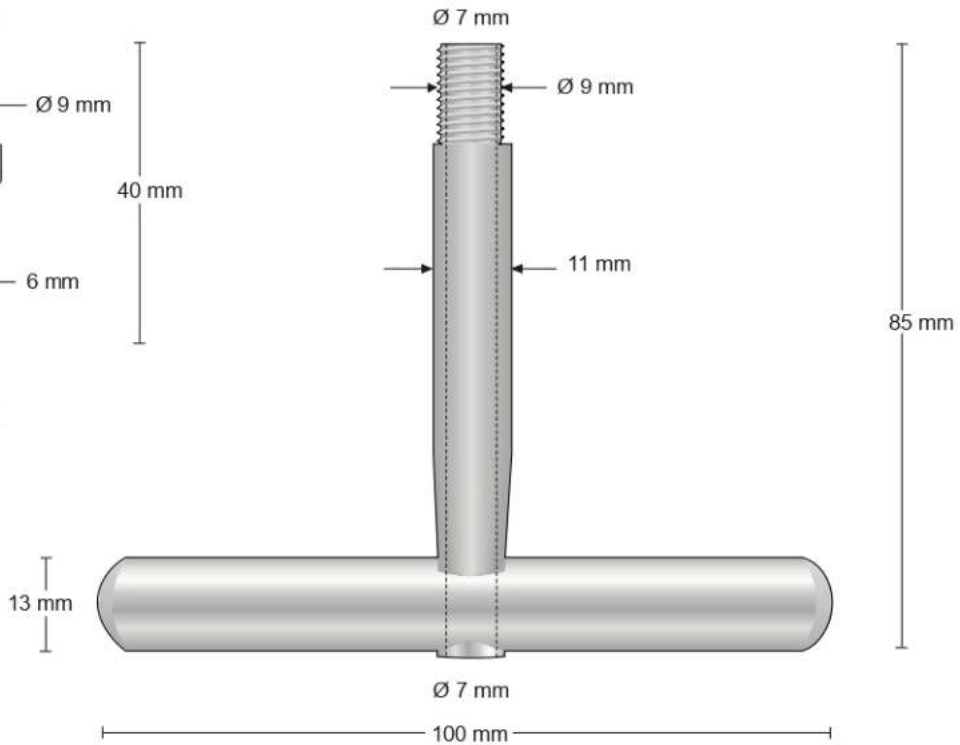
ST-6784-2
50 mm



ST-6784-3
52 mm



ST-6784-4
40 mm

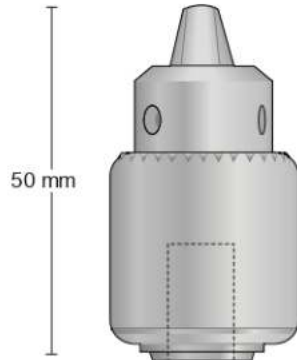


ST-6784-5
85 mm

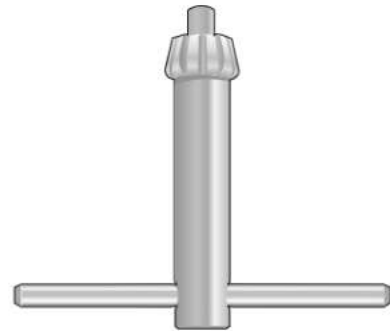


ST-6785
Completo con - Complete with
Komplett mit - Completes avec
Completo con:
1
1
1
1

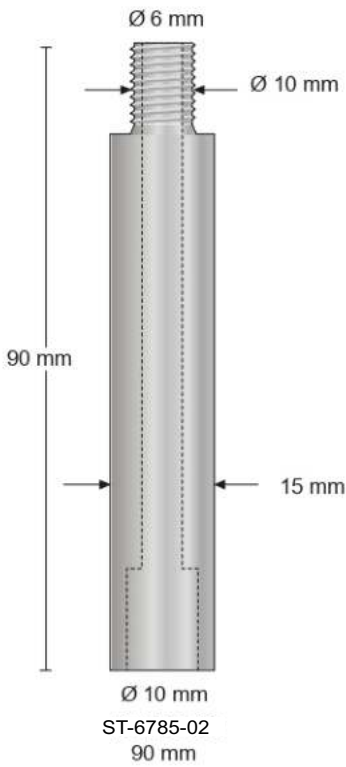
Inox
ORIGINAL JACOBS



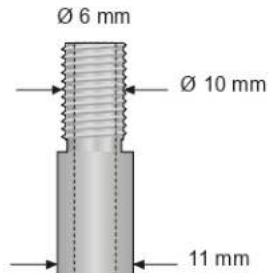
Ø 10 mm
ST-6785-01
50 mm



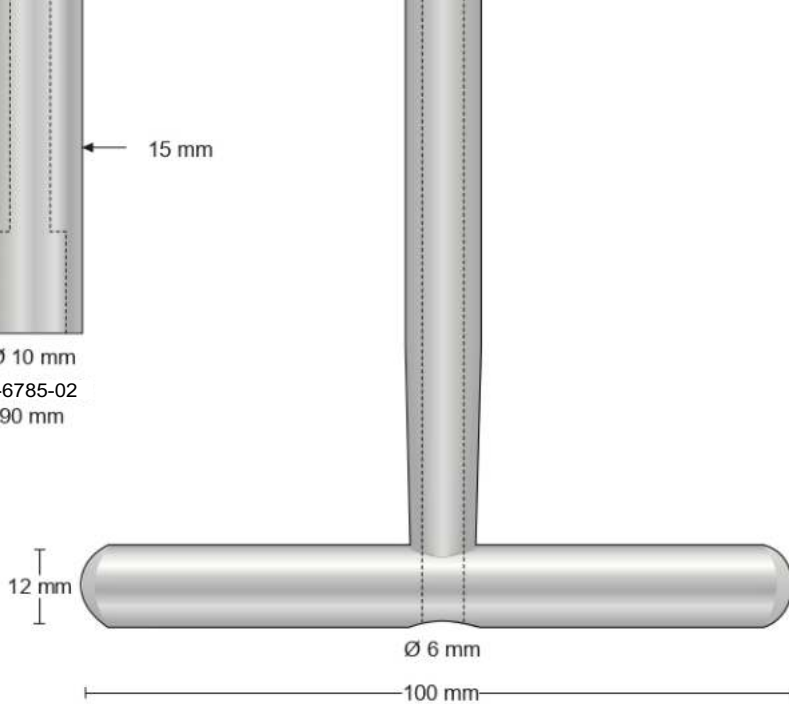
ST-6785-04
52 mm



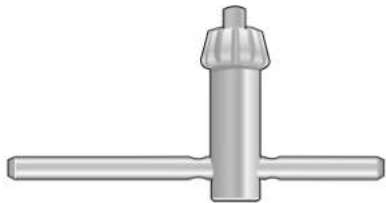
Ø 10 mm
ST-6785-02
90 mm



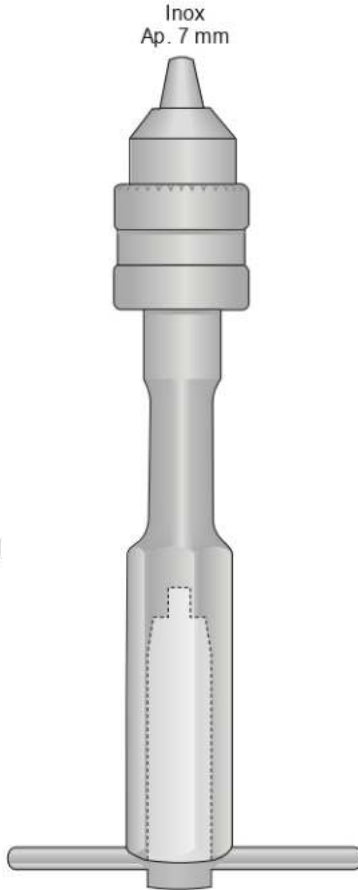
ST-6785-03
130 mm



130 mm



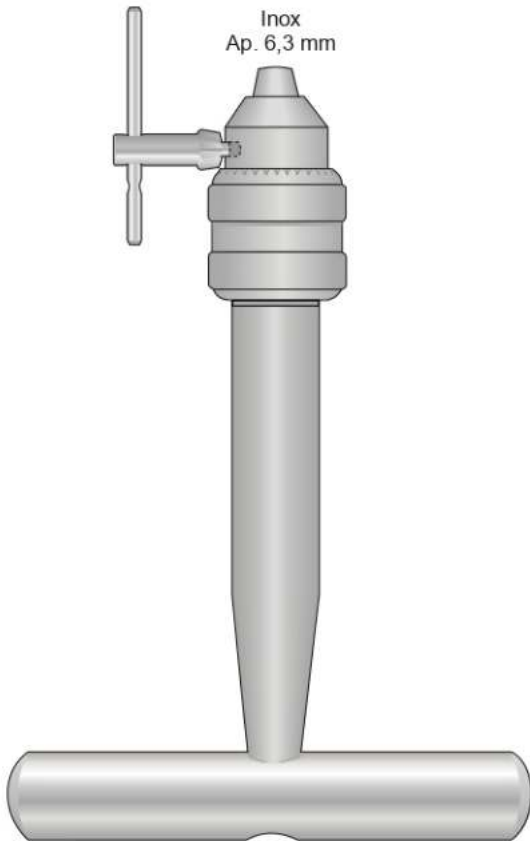
ST-6786-2
32 mm



Inox
Ap. 7 mm

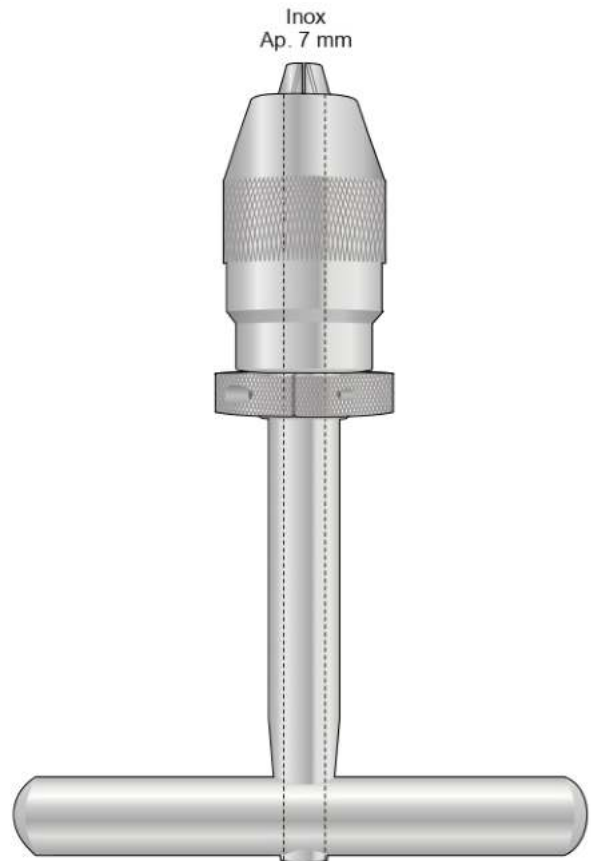
ST-6786-1
130 mm

Con chiusura a mano
Von Hand zu spannen
tightened by hand



Inox
Ap. 6,3 mm

ST-6787
130 mm

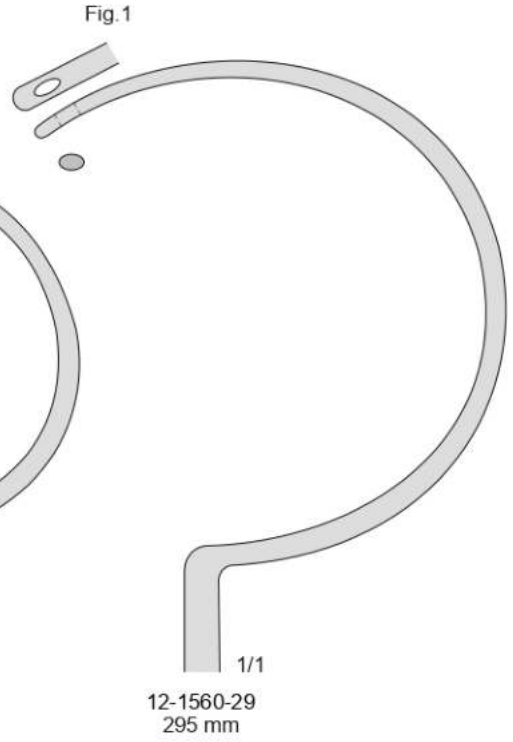
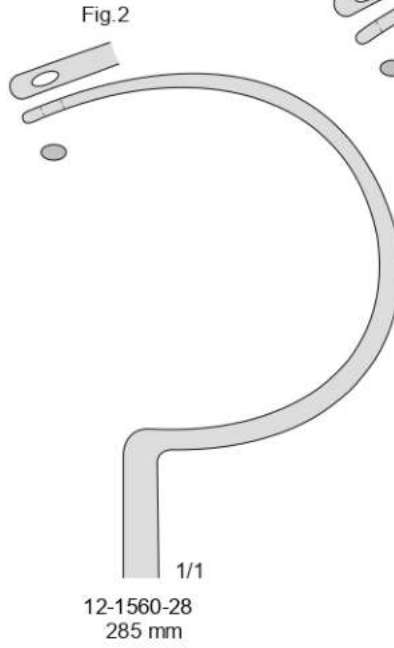
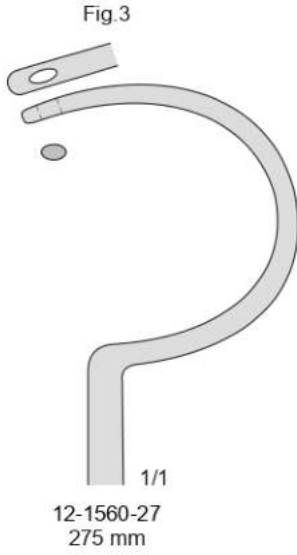


Inox
Ap. 7 mm

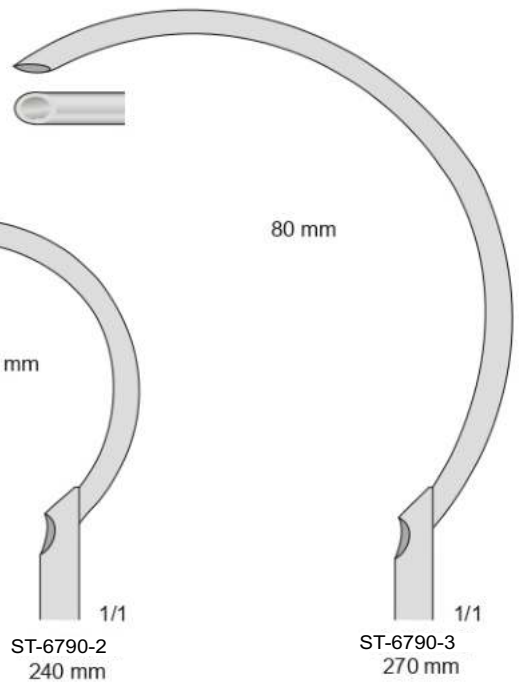
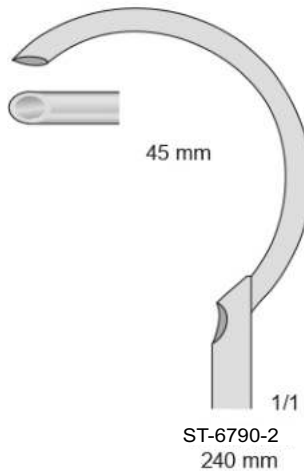
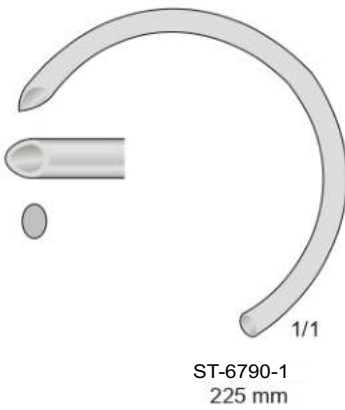
ST-6788
135 mm

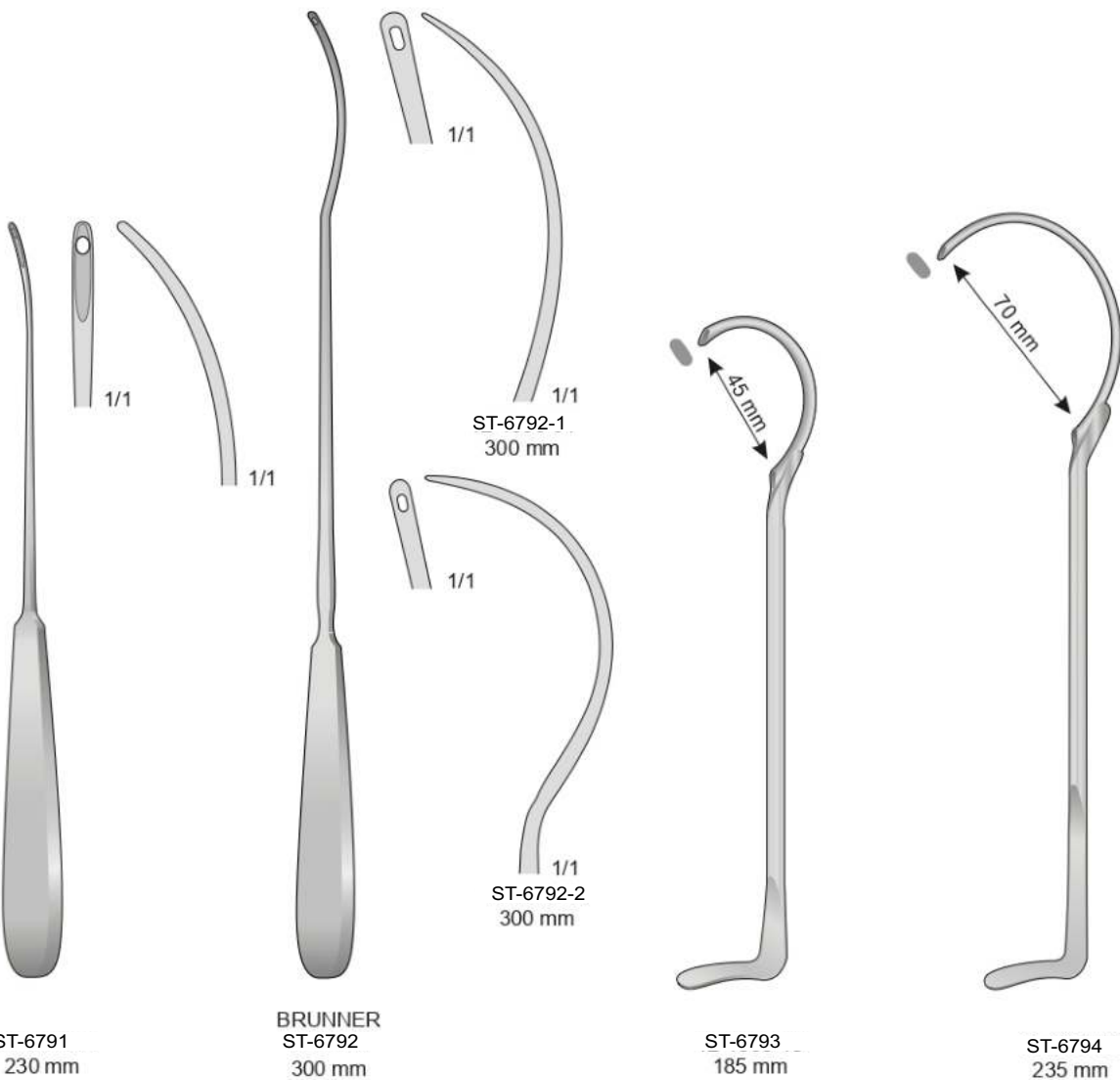


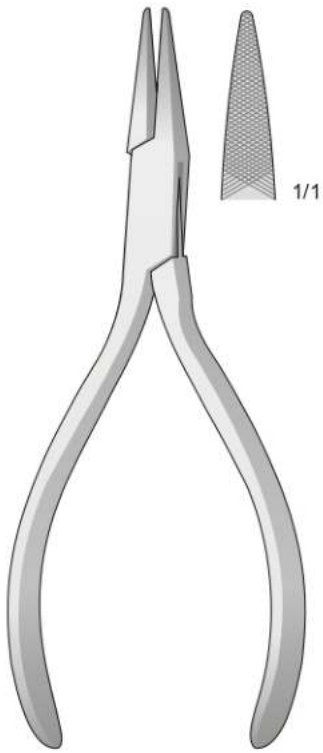
DEMEL
12-1560



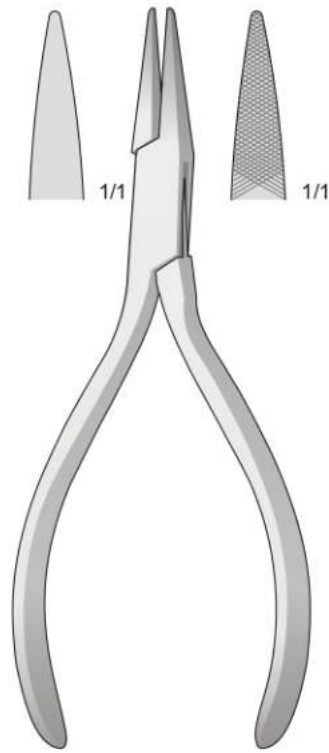
ST-6790
225 mm





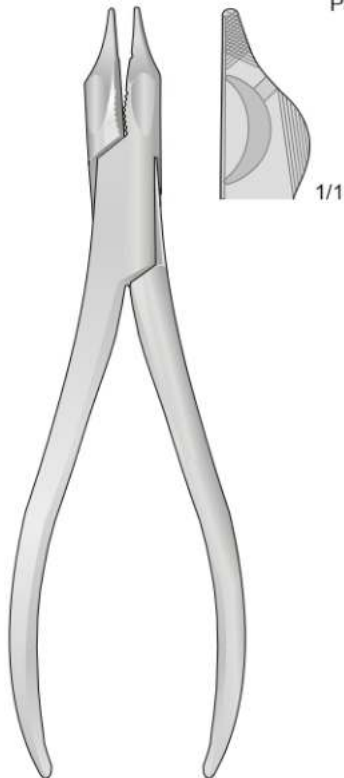


ST-6795
140 mm

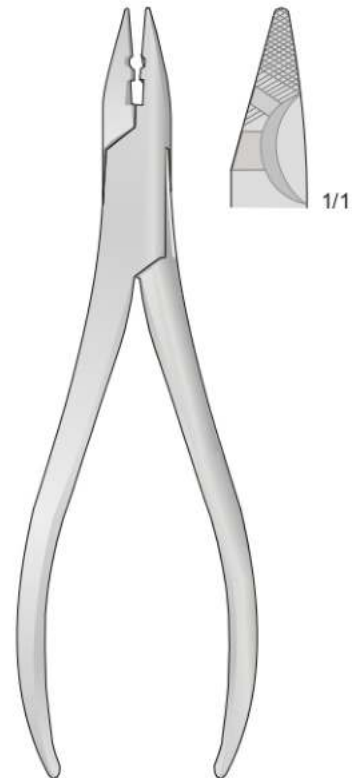


ST-6796
140 mm

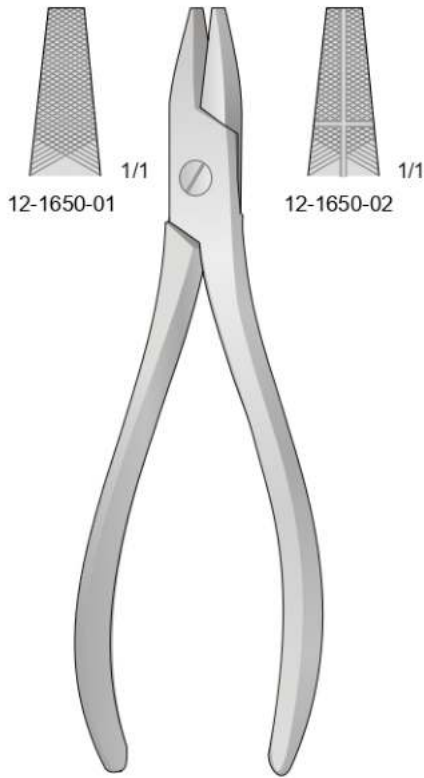
Per filo duro ø 1 mm
For hard wire ø 1 mm
Für harten draht ø 1 mm
Pour fil dur ø 1 mm
Para alambres duro ø 1 mm



ST-6797
150 mm

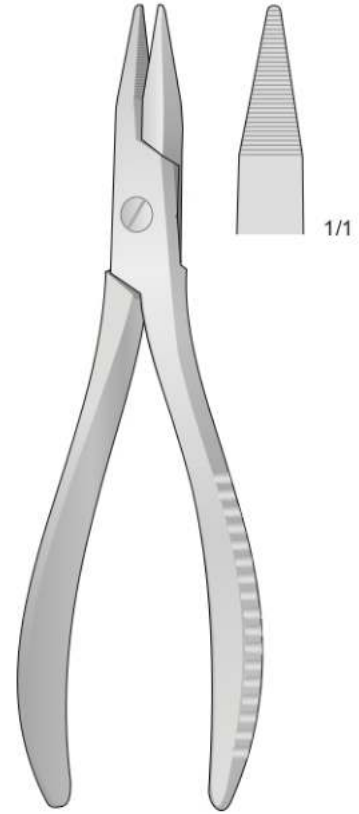


ST-6798
160 mm



12-1650-01

12-1650-02

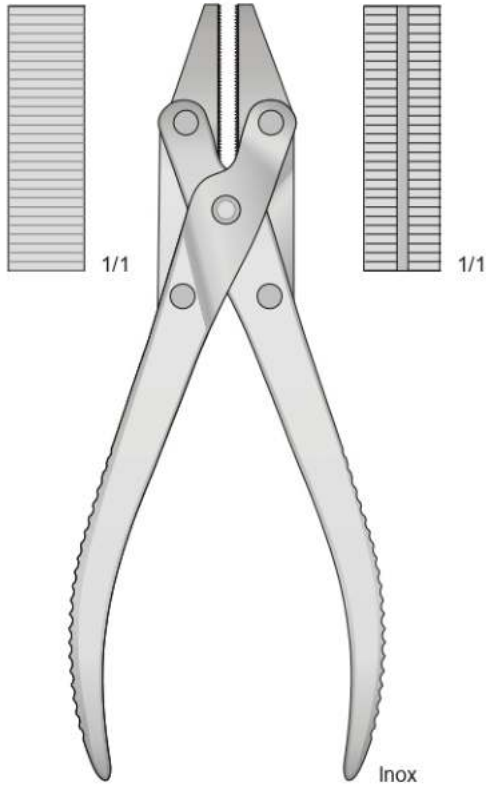


ST-6800
190 mm

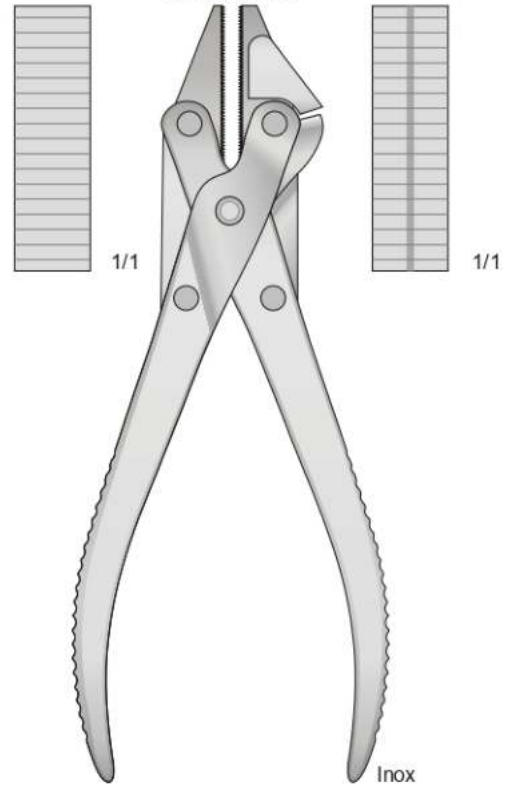
ST-6799
175 mm

Pinza per estrazione
fili metallici
Flachzangen für draht

Pinza a branche parallele
con tronchese



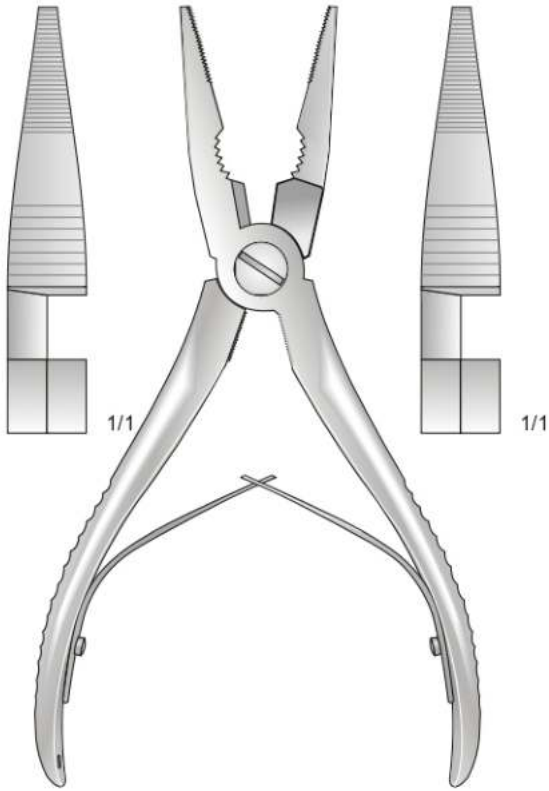
ST-6801
185 mm



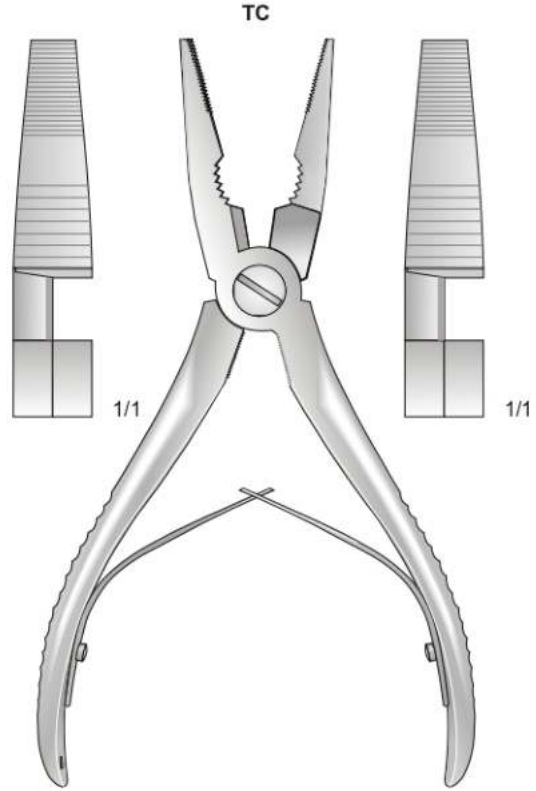
ST-6802
185 mm

Inox

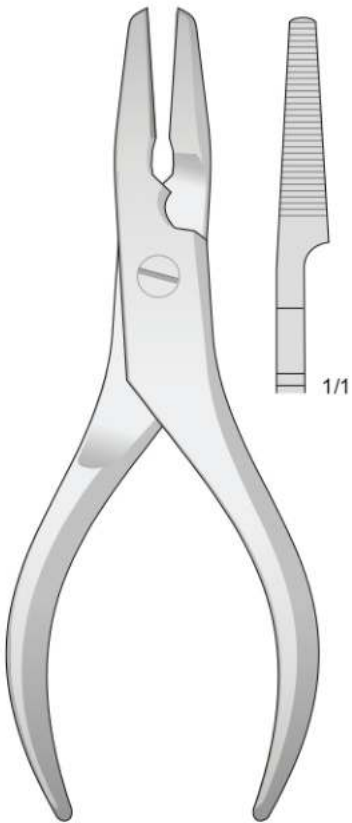
Inox



ST-6803
175 mm



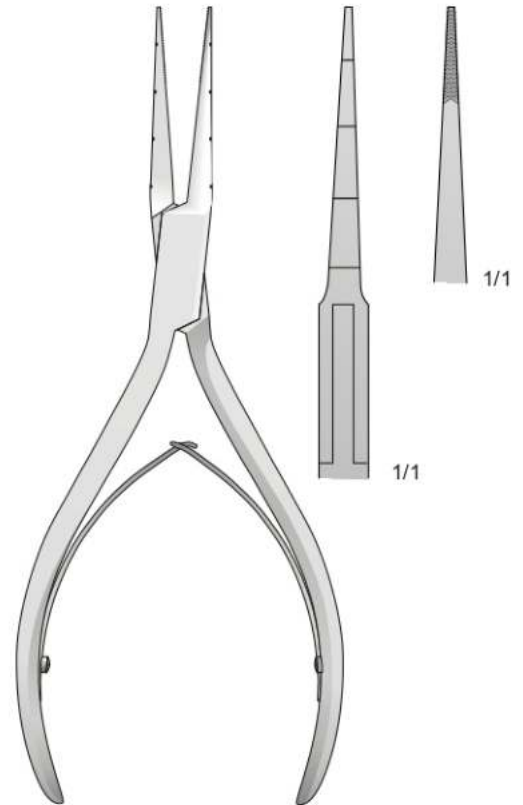
ST-6804
165 mm



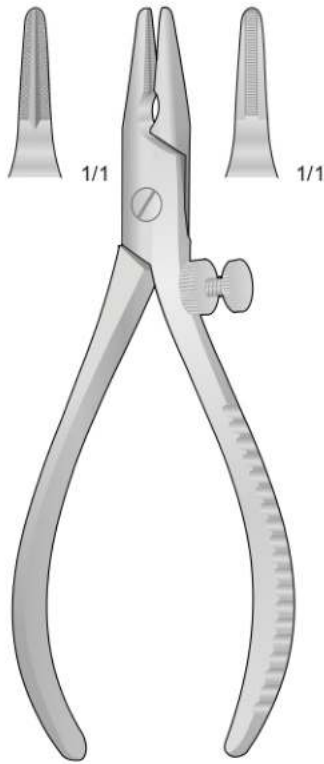
ST-6805
160 mm



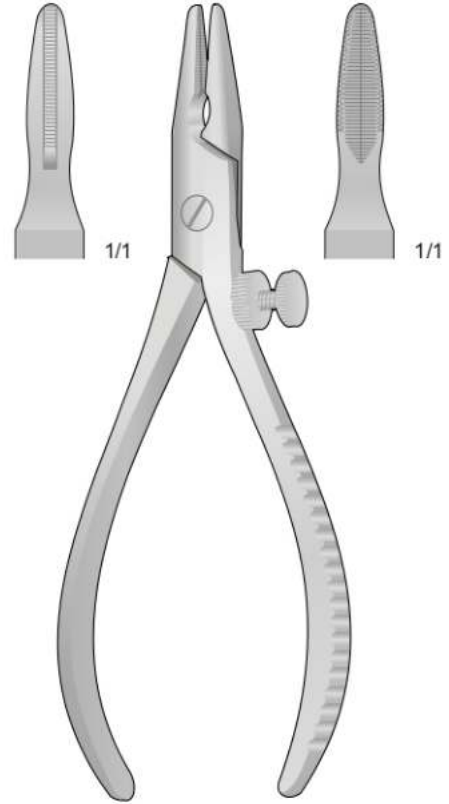
12-1700-20
200 mm



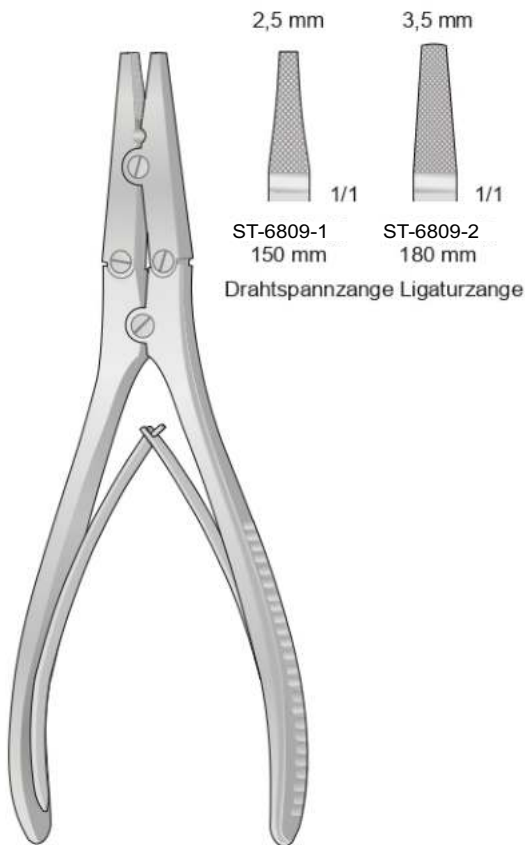
ST-6806
150 mm



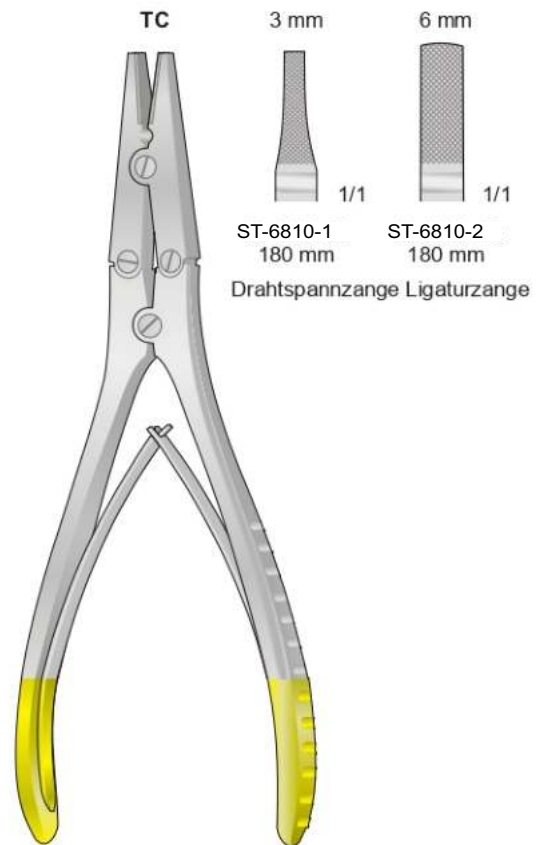
ST-6807
140 mm



ST-6808
180 mm



ST-6809

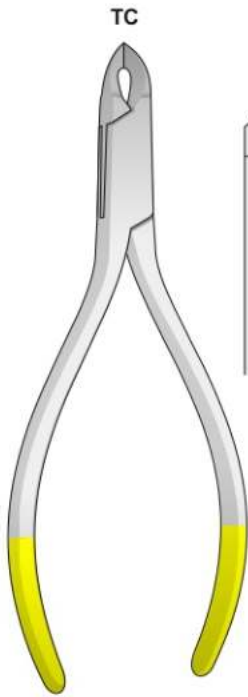


ST-6810

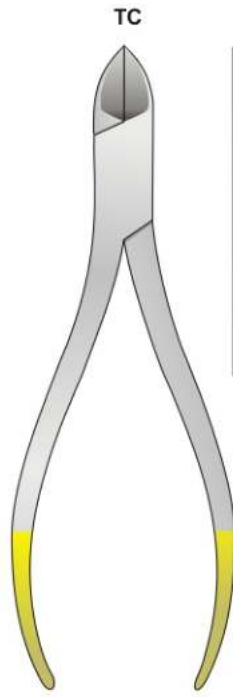


Per fili duri di \varnothing 0,4 mm - For hard wire with \varnothing 0,4 mm
Für harten Draht bis \varnothing 0,4 mm - Pour fils durs avec \varnothing 0,4 mm
Para hilos duros de \varnothing 0,4 mm

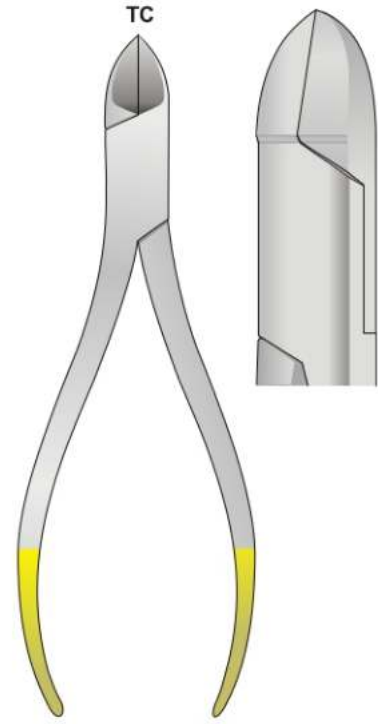
Per filo duro \varnothing 1 mm - Für harten draht \varnothing 1 mm
For hard wire \varnothing 1 mm - Pour fil dur avec \varnothing 1 mm
Para alambres duro \varnothing 1 mm



ANGLE
ST-6811
130 mm

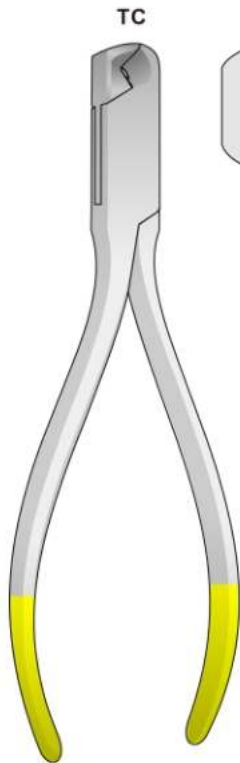


ST-6812
130 mm

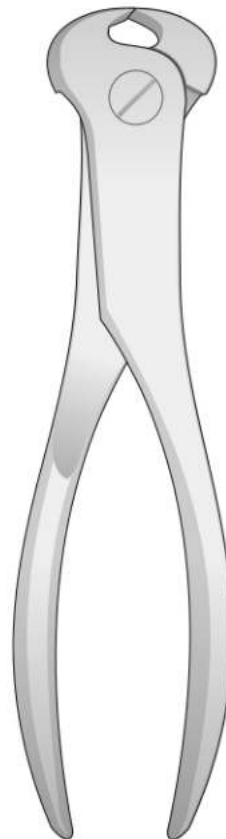


ST-6813
150 mm

Per filo duro \varnothing 1 mm - Für harten draht \varnothing 1 mm
For hard wire \varnothing 1 mm - Pour fil dur avec \varnothing 1 mm
Para alambres duro \varnothing 1 mm



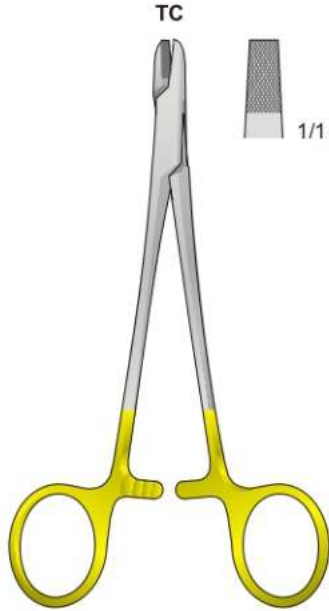
ST-6814
145 mm



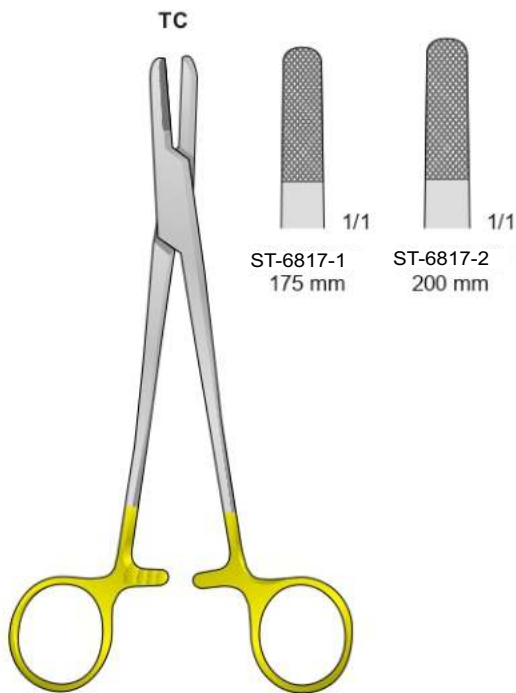
ST-6815
185 mm



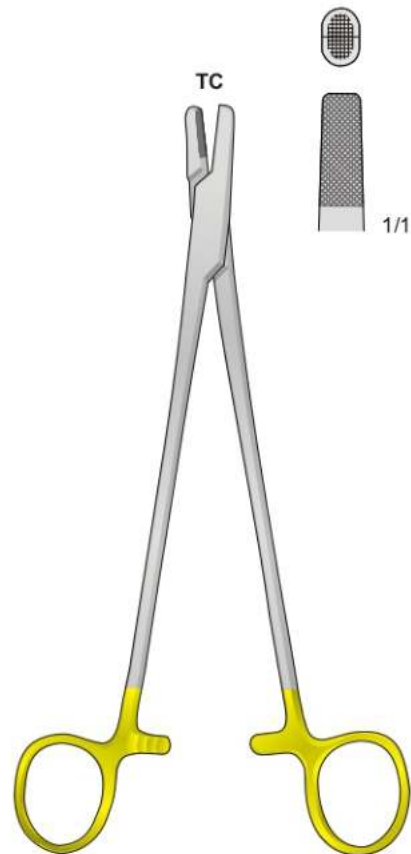
Port' aghi, pinze per fili d'acciaio
Needle holders, wire forceps
Nadelhalter, Draht-zangen
Porte aiguilles, pinces à saisir
Porta agujas, pinzas para hilos



ST-6816
150 mm

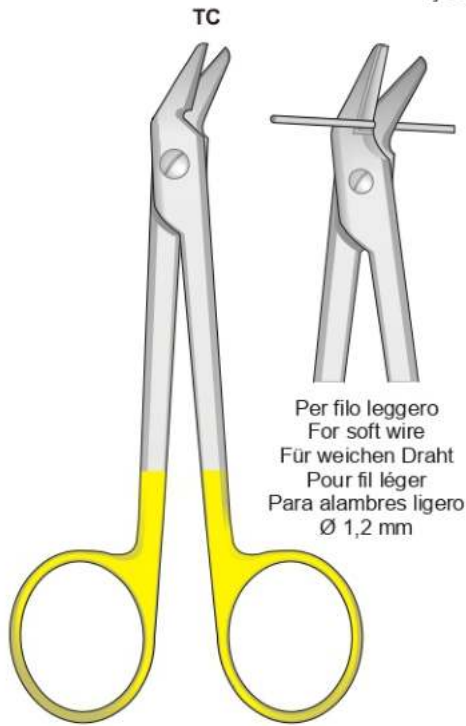


ST-6817

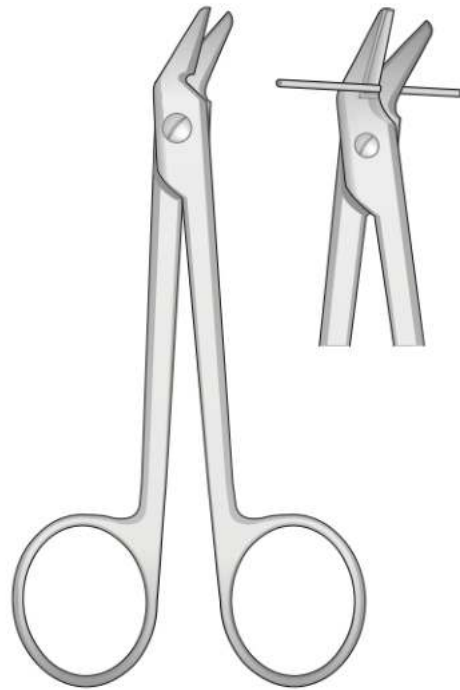


BAUMGARTNER
ST-6818
200 mm

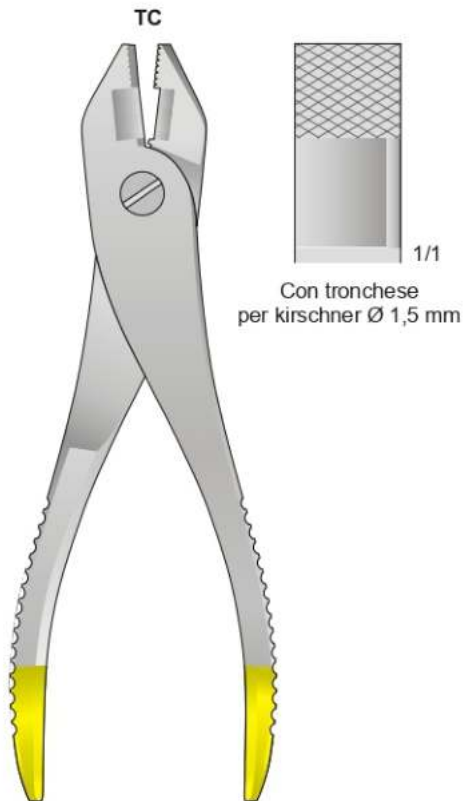
Forbice universale dentellata - Draht-und Blechscherer gezahnt
Wire cutting scissor serrated - Ciseaux à couper les fils métalliques
Tijeras para cortar hilo de acero dentadas



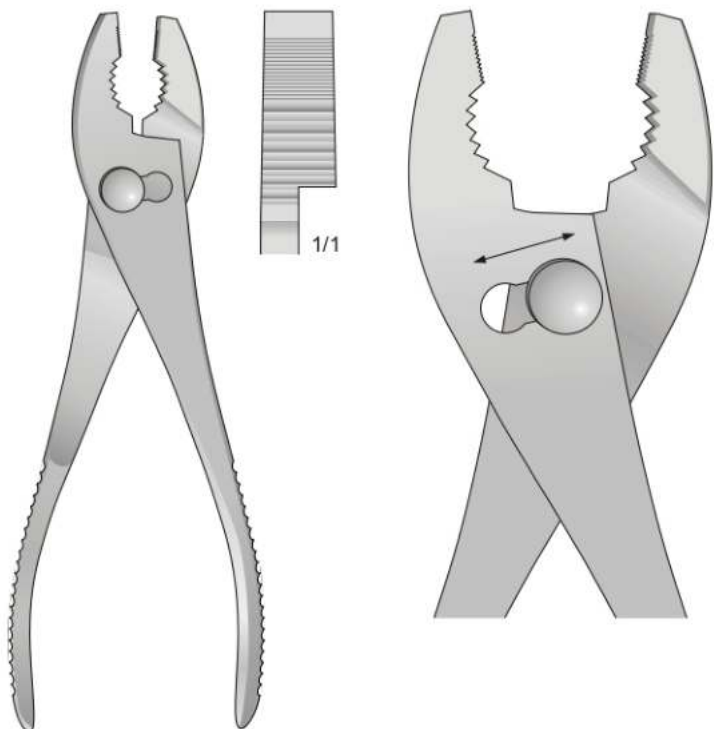
ST-6819
120 mm



ST-6820
120 mm



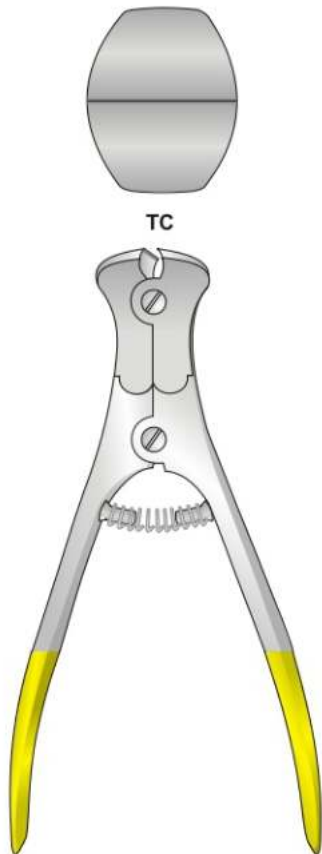
ST-6821
220 mm



ST-6822
200 mm

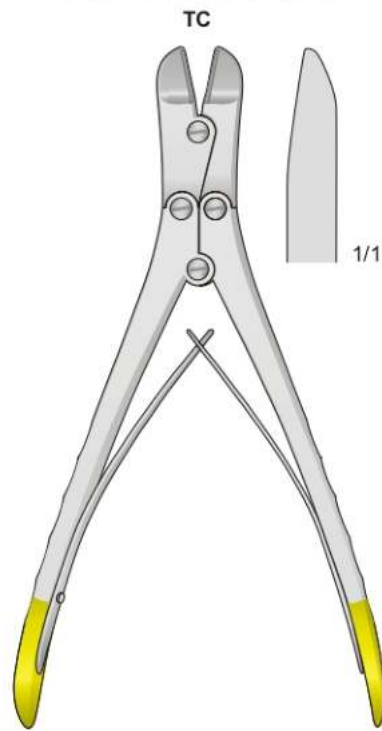


Per filo leggero Ø 2 mm
 Per filo duro Ø 1,5 mm
 For soft wire Ø 2 mm
 For hard wire Ø 1,5 mm
 Für weichen Draht Ø 2 mm
 Für harten Draht Ø 1,5 mm
 Pour fil léger Ø 2 mm
 Pour fil dur Ø 1,5 mm
 Para alambres ligero Ø 2 mm
 Para alambres duro Ø 1,5 mm



ST-6823
145 mm

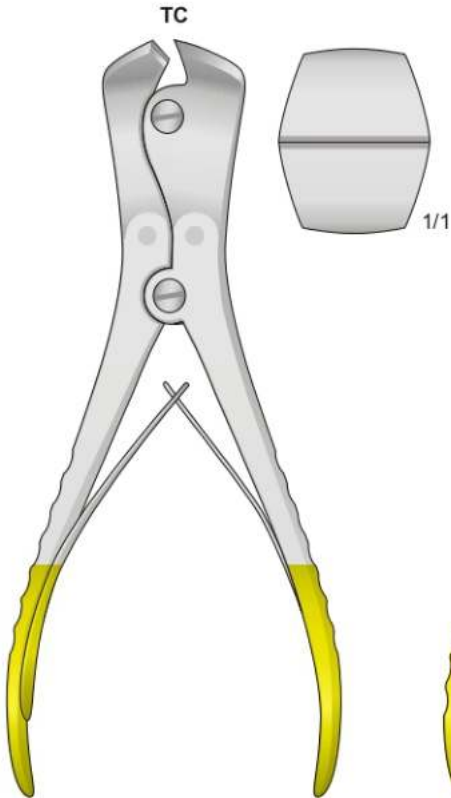
Per filo leggero Ø 2 mm
 Per filo duro Ø 1,6 mm
 For soft wire Ø 2 mm
 For hard wire Ø 1,6 mm
 Für weichen Draht Ø 2 mm
 Für harten Draht Ø 1,6 mm
 Pour fil léger Ø 2 mm
 Pour fil dur Ø 1,6 mm
 Para alambres ligero Ø 2 mm
 Para alambres duro Ø 1,6 mm



ST-6824
170 mm

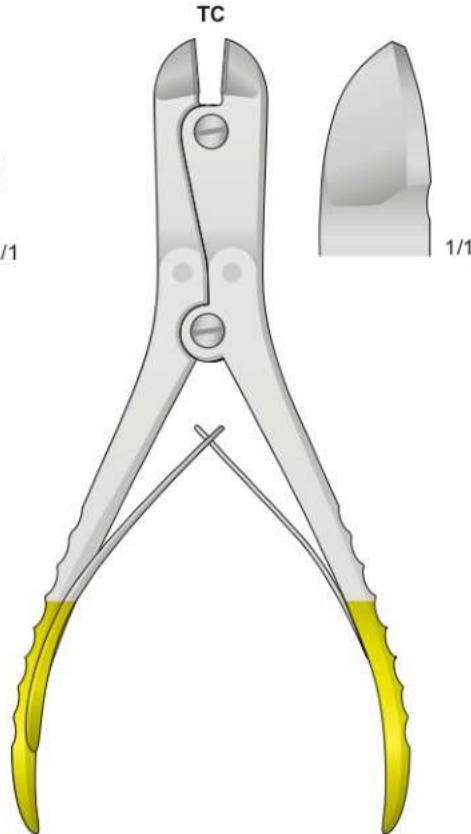


Per filo leggero Ø 3,5 mm
 Per filo duro Ø 2,5 mm
 For soft wire Ø 3,5 mm
 For hard wire Ø 2,5 mm
 Für weichen Draht Ø 3,5 mm
 Für harten Draht Ø 2,5 mm
 Pour fil léger Ø 3,5 mm
 Pour fil dur Ø 2,5 mm
 Para alambres ligero Ø 3,5 mm
 Para alambres duro Ø 2,5 mm



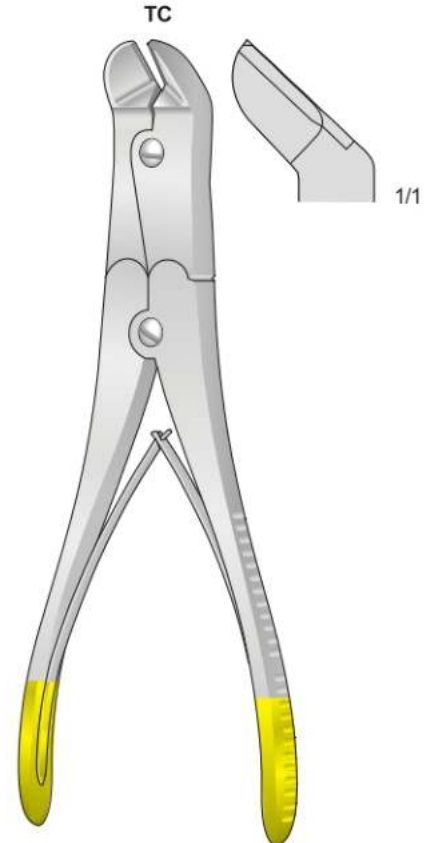
ST-6825
215 mm

Per filo leggero Ø 3 mm
 Per filo duro Ø 2,2 mm
 For soft wire Ø 3 mm
 For hard wire Ø 2,2 mm
 Für weichen Draht Ø 3 mm
 Für harten Draht Ø 2,2 mm
 Pour fil léger Ø 3 mm
 Pour fil dur Ø 2,2 mm
 Para alambres ligero Ø 3 mm
 Para alambres duro Ø 2,2 mm



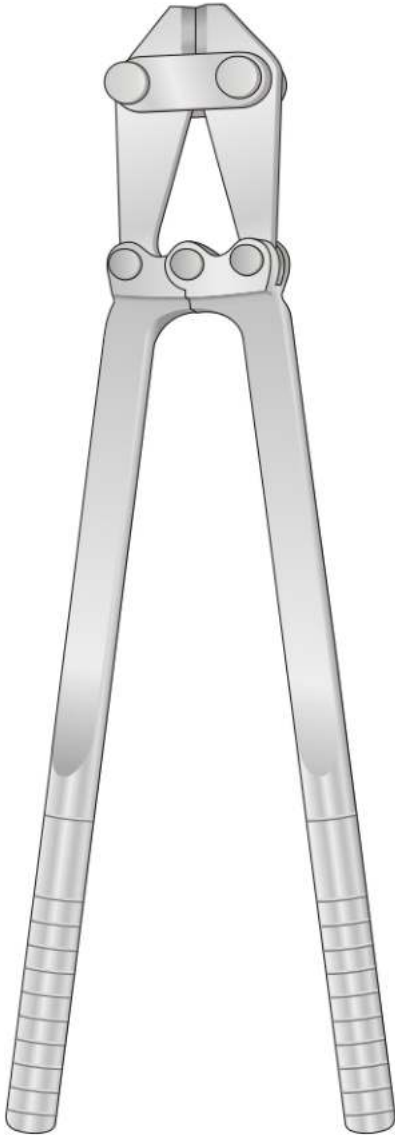
ST-6826
230 mm

Per filo leggero Ø 2,5 mm
 Per filo duro Ø 2 mm
 For soft wire Ø 2,5 mm
 For hard wire Ø 2 mm
 Für weichen Draht Ø 2,5 mm
 Für harten Draht Ø 2 mm
 Pour fil léger Ø 2,5 mm
 Pour fil dur Ø 2 mm
 Para alambres ligero Ø 2,5 mm
 Para alambres duro Ø 2 mm



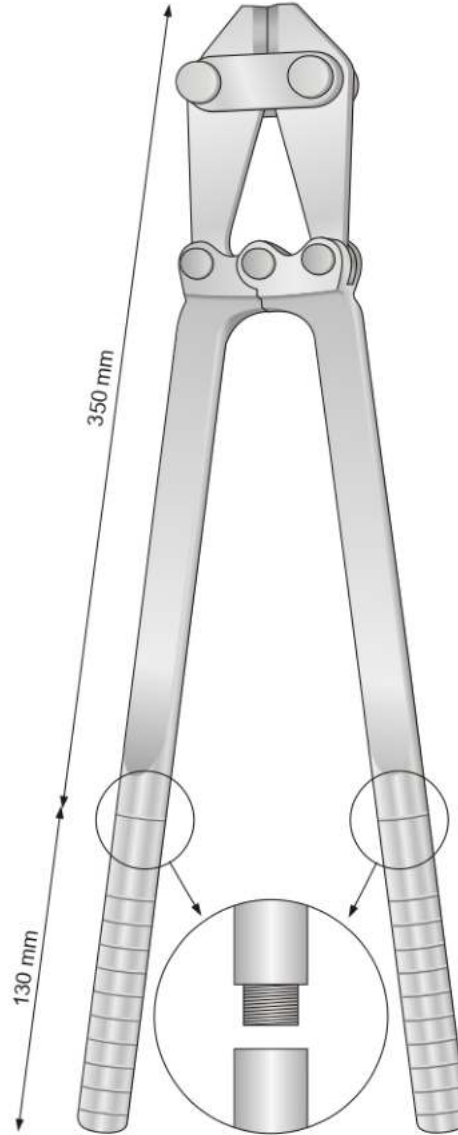
ST-6827
230 mm

Per filo leggero Ø 7 mm
 Per filo duro Ø 6 mm
 For soft wire Ø 7 mm
 For hard wire Ø 6 mm
 Für weichen Draht Ø 7 mm
 Für harten Draht Ø 6 mm
 Pour fil léger Ø 7 mm
 Pour fil dur Ø 6 mm
 Para alambres ligero Ø 7 mm
 Para alambres duro Ø 6 mm



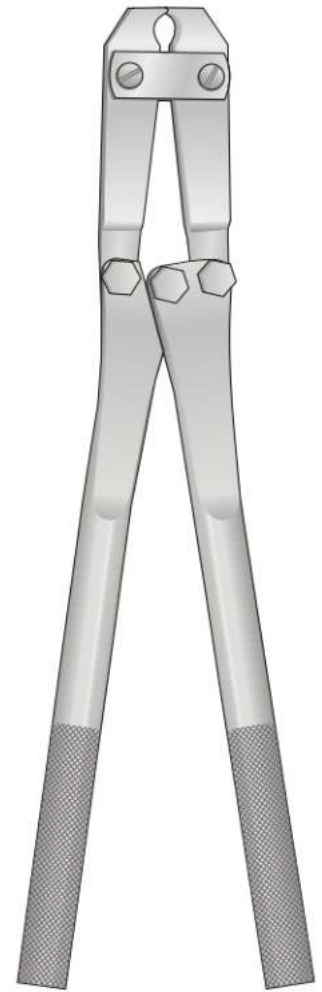
ST-6828
480 mm

Per filo leggero Ø 7 mm
 Per filo duro Ø 6 mm
 For soft wire Ø 7 mm
 For hard wire Ø 6 mm
 Für weichen Draht Ø 7 mm
 Für harten Draht Ø 6 mm
 Pour fil léger Ø 7 mm
 Pour fil dur Ø 6 mm
 Para alambres ligero Ø 7 mm
 Para alambres duro Ø 6 mm



ST-6829
480 mm

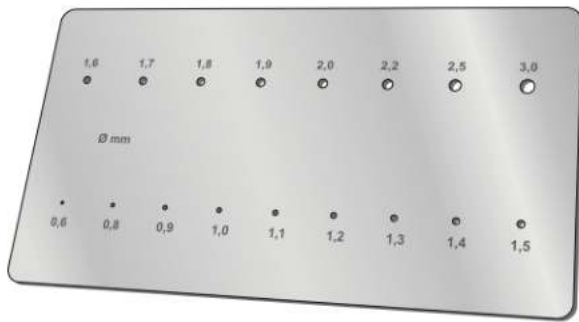
Per filo leggero Ø 5 mm
 Per filo duro Ø 4,5 mm
 For soft wire Ø 5 mm
 For hard wire Ø 4,5 mm
 Für weichen Draht Ø 5 mm
 Für harten Draht Ø 4,5 mm
 Pour fil léger Ø 5 mm
 Pour fil dur Ø 4,5 mm
 Para alambres ligero Ø 5 mm
 Para alambres duro Ø 4,5 mm



ST-6830
375 mm



Misuratore per chiodi Kirschner
Meßlehre für Kirschnerdrähte



0,5 mm



0,5 mm



0,5 mm



0,5 mm



ST-6831
50 mm

ST-6832
120 mm

ST-6833
150 mm

ST-6834
300 mm

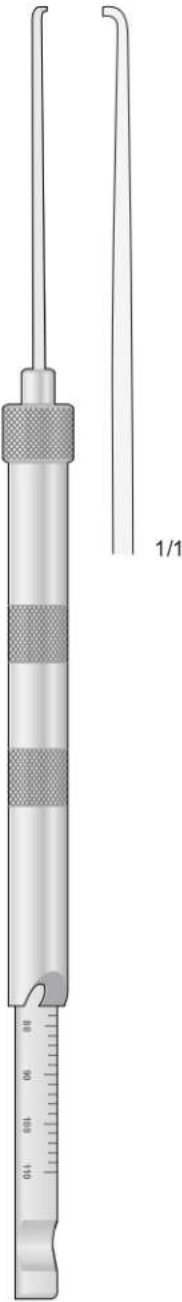


Misuratore di lunghezza per viti
Screw depth gauges, to select proper length of screw
Instruments de mesure de profondeur pour determiner la longueur de vis requise

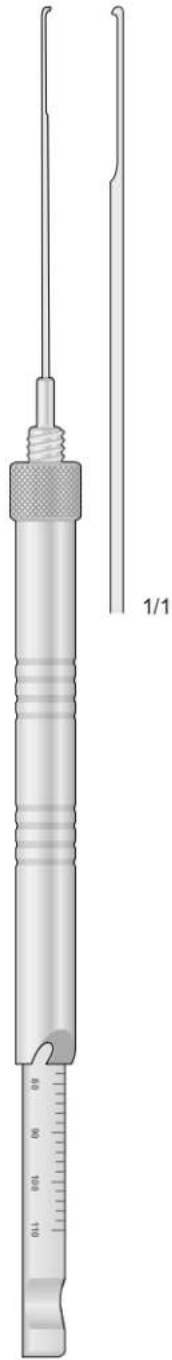
Per viti Ø
For screw Ø
Für Schrauben Ø
Pour vis de Ø



ST-6835
165 mm



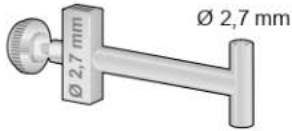
ST-6836
265 mm



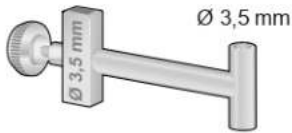
ST-6837
280 mm



ST-6838-2

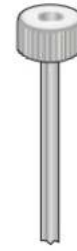


ST-6838-3



ST-6838-4

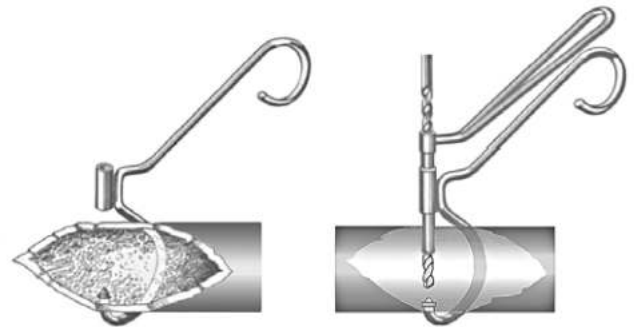
Centrapunte
Manicotto dentato
Steckbohrbüchsen
Insert-drill



Ø Esterno	Ø Per punte
Ø Outside	Ø For drills
Ø Außen	Ø Für Bohrer
Ø Extérieur	Ø Pour Mèches
Ø Exterior	Ø Para agujas

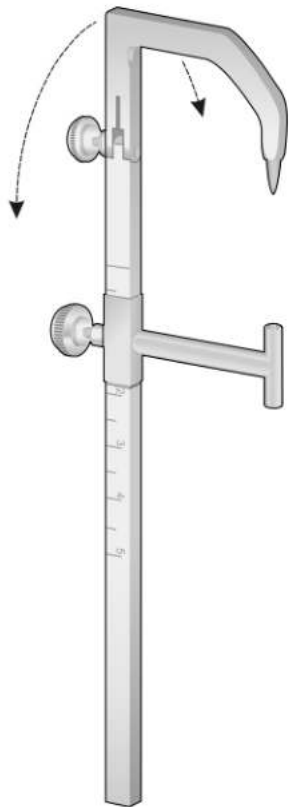
Cod. Art.	Ø Esterno	Ø Per punte
ST-6839-1	4,5 mm	3,2 mm
ST-6839-2	3,5 mm	2 mm
ST-6839-3	3,5 mm	2,7 mm

Guida per punte elicoidali
Gewebeschützülzen

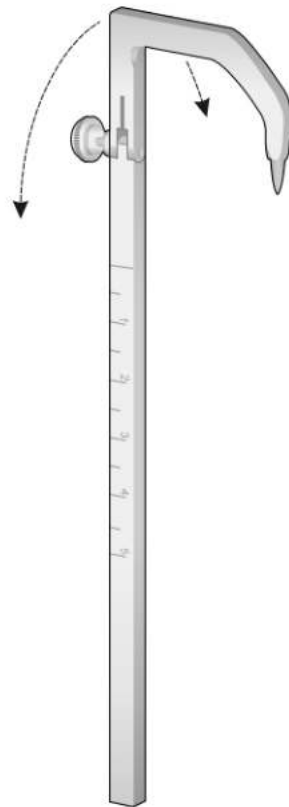


12-1940-05
Completo di 3 guide

12-1940-01
Centratore solo

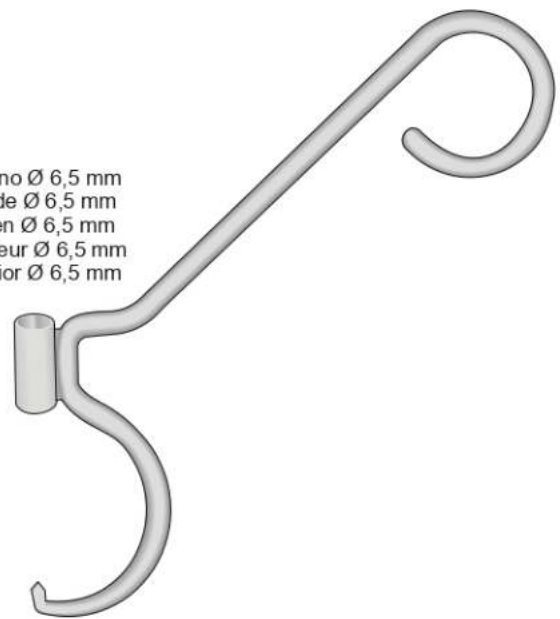


ST-6838
145 mm



ST-6838-1
145 mm

Interno Ø 6,5 mm
Inside Ø 6,5 mm
Innen Ø 6,5 mm
Intérieur Ø 6,5 mm
Interior Ø 6,5 mm



ST-6839

Attacco Dentale
Dental schaft

Ø 1,5 mm



ST-6840-9
50 mm

Ø 2,0 mm



ST-6840-10
55 mm

Attacco AO
Mit AO schaft

Ø 1,5 mm



ST-6840-1
65 mm

Ø 2 mm



ST-6840-2
70 mm

Ø 2,7 mm



ST-6840-3
100 mm

Passo della vite
a 1,25 mm

Ø 3,5 mm



ST-6840-4
110 mm

Passo della vite
a 1,75 mm

Ø 3,5 mm



ST-6840-5
110 mm

Ø 4,5 mm



ST-6840-6
130 mm

Ø 4,5 mm



ST-6840-7
130 mm

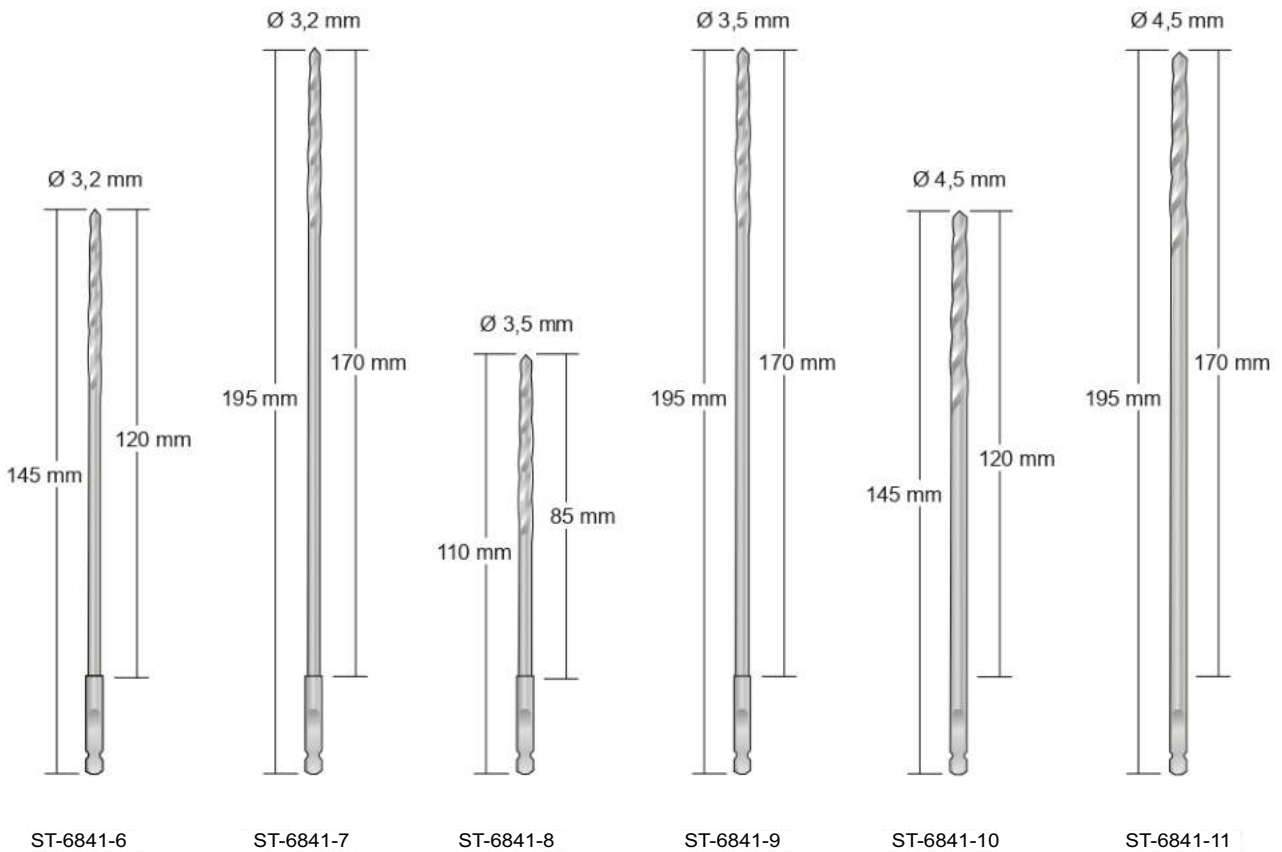
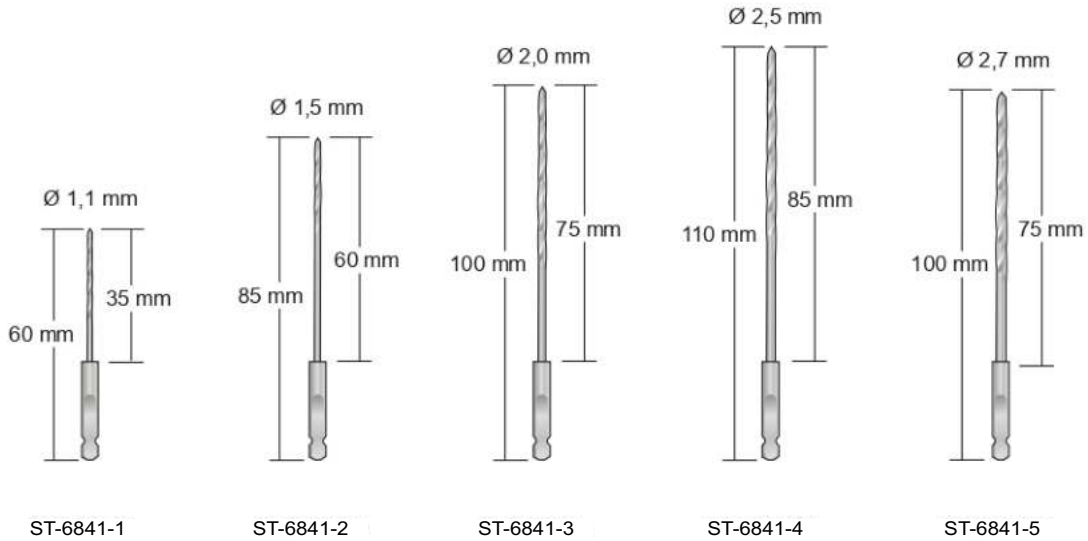
Ø 6,5 mm



ST-6840-8
170 mm

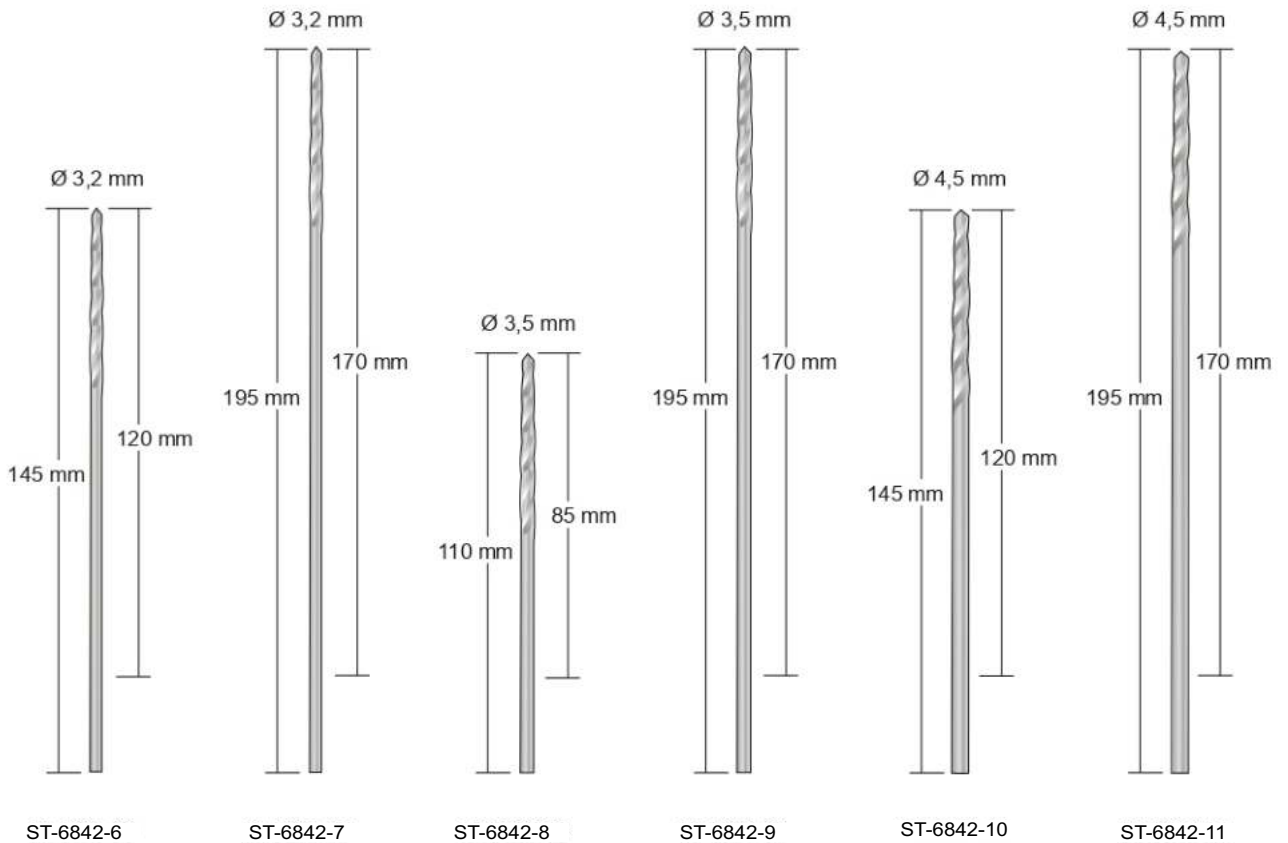
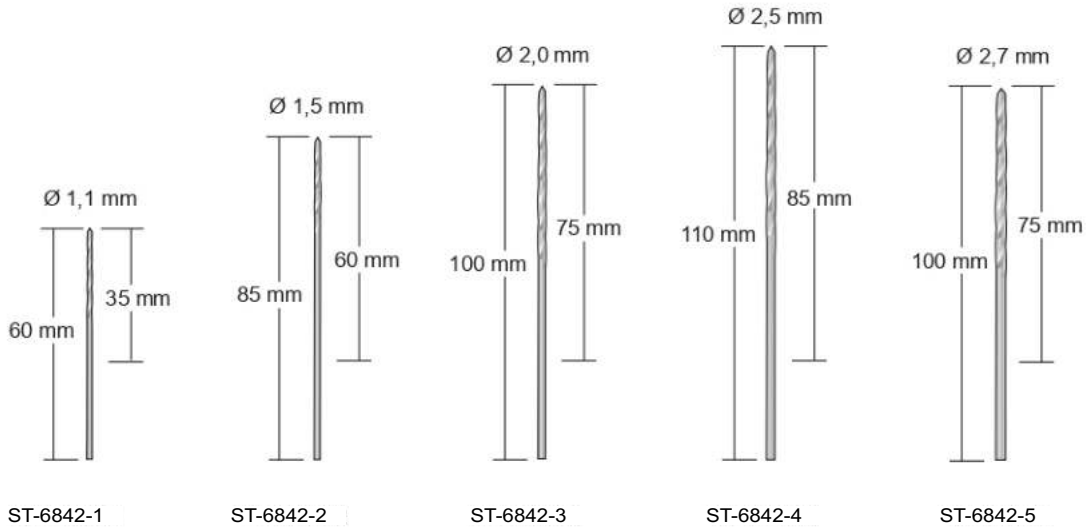
Punte elicoidali con innesto rapido

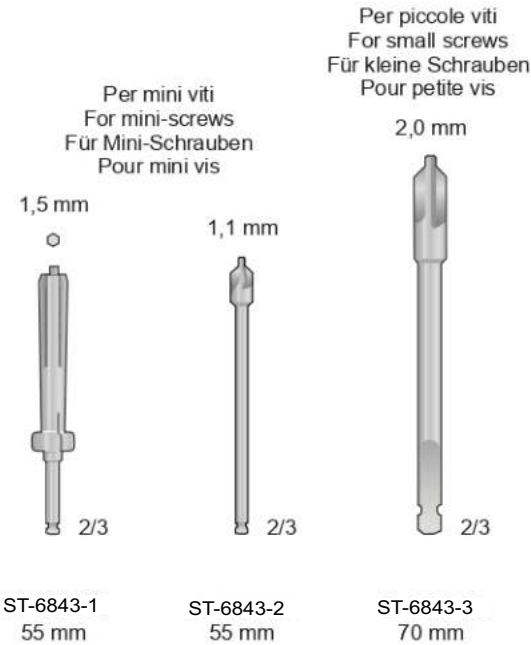
Attacco AO
Mit AO schaft
Drill bits



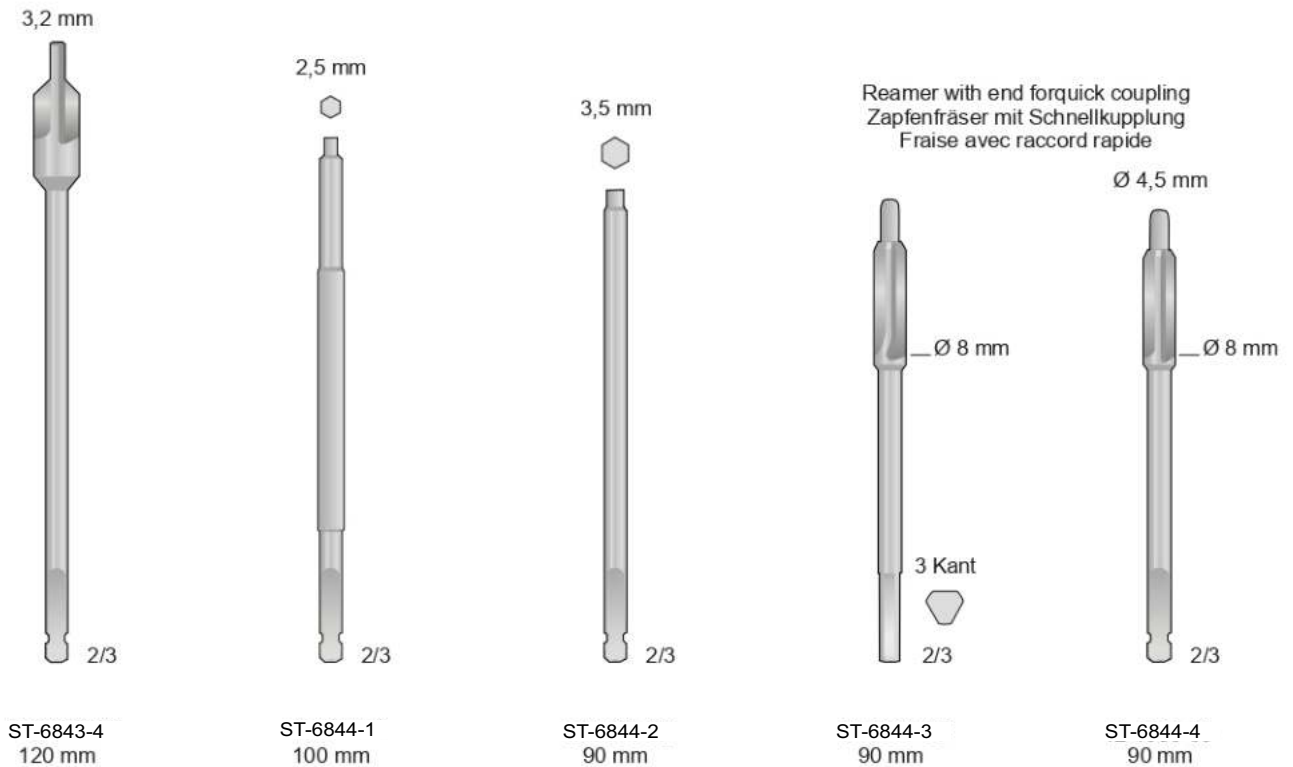
Punte elicoidali

Con attacco rotondo
Mit rundschaft
Drill bits





Per viti malleolari
For malleolar screws
Für Malleolarschrauben
Pour vis à malléole



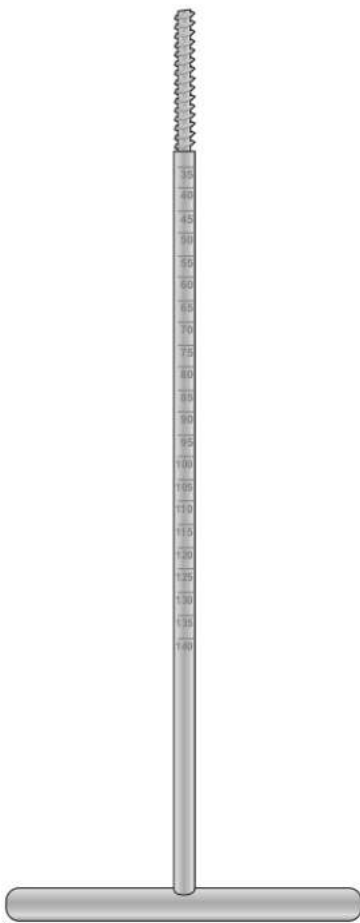
Manico con mandrino rapido
Handles with quick-action chuck
Handgriffe mit schnellspann futter
Poignées avec mandrins rapides

Ø 4 mm

AO-Schaft

Dental-Schaft

4kant-Schaft



ST-6844
260 mm



MANICO FERROZELL
ST-6845
125 mm



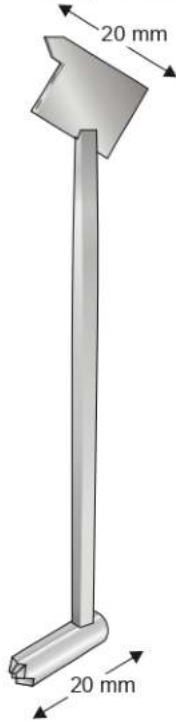
ST-6846
110 mm



ST-6847
80 mm

Centratori guida punte - Drill guides - Bohrbüchsen zu Knochenplatten - Guide méche

Per trapano Ø 2 mm



ST-6848
110 mm

Per viti da corticale Ø 3,5 mm
Per maschiatore Ø 2,5 mm



ST-6849

Per viti da corticale Ø 6,5 mm
Per maschiatore Ø 3,2 mm



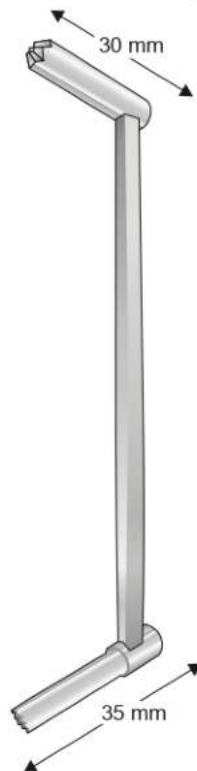
ST-6850

Per trapano Ø 1,1/1,5 mm



ST-6851
105 mm

Per trapano Ø 2,5 mm
Per viti da corticale Ø 3,5 mm
Per maschiatore Ø 3,5 mm



ST-6852
125 mm

Per viti da corticale Ø 4,5 mm
Per maschiatore Ø 3,2 mm

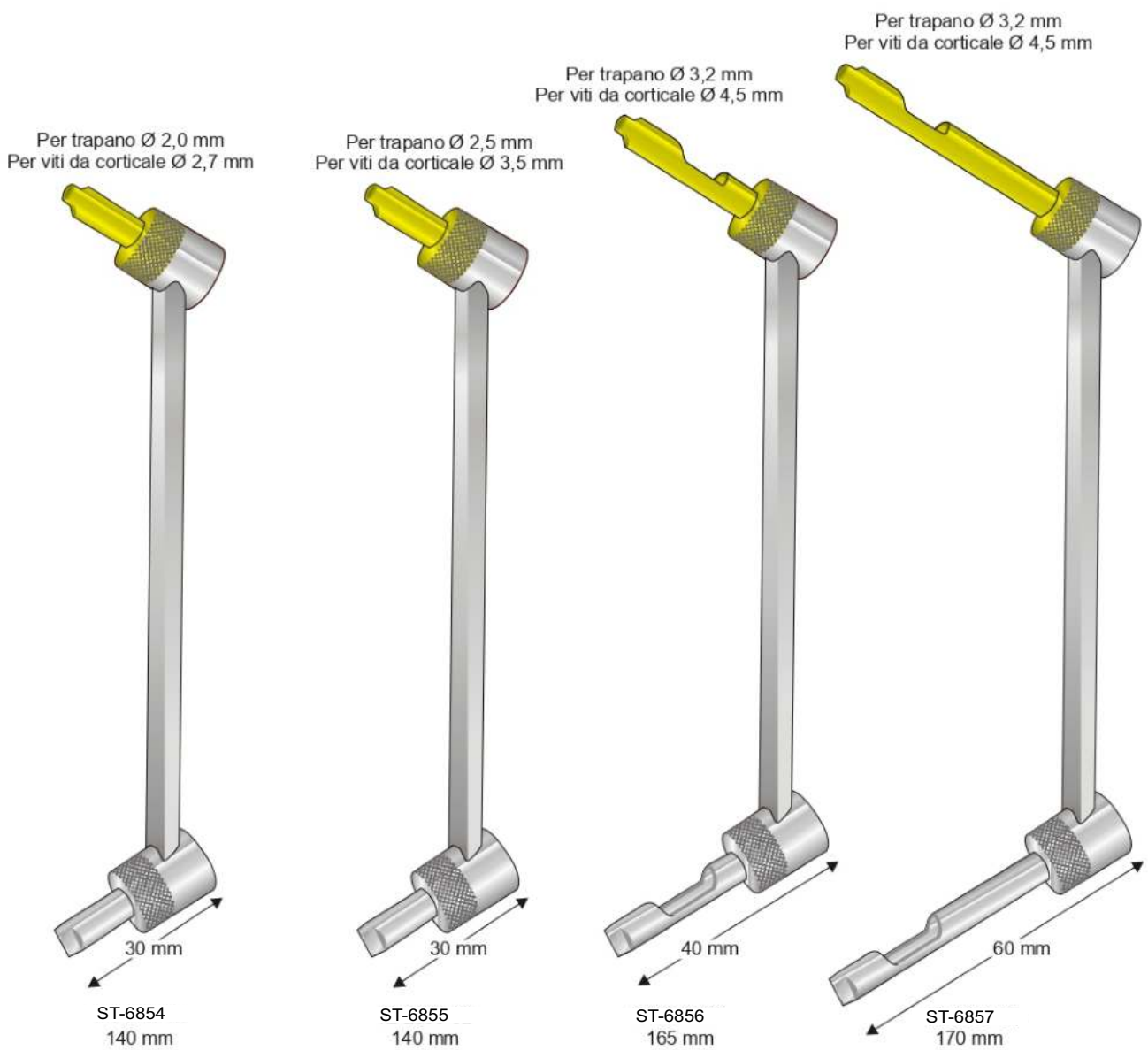


ST-6853

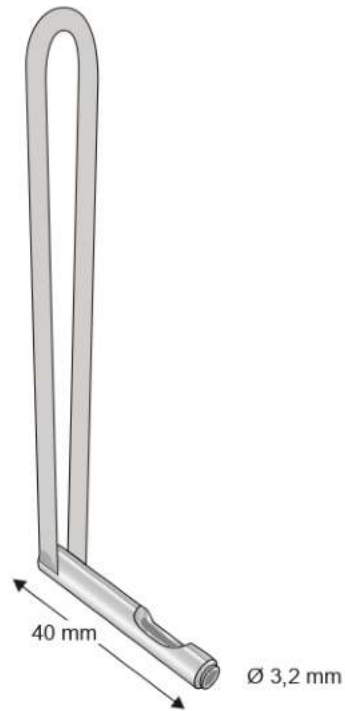
Centratori guida punte - Drill guides - Bohrbüchsen zu Knochenplatten - Guide méche

Codificazione del colore

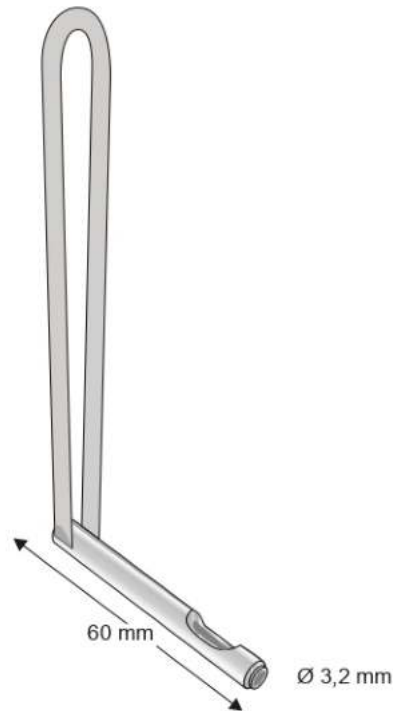
verde = centrico
oro = eccentrico



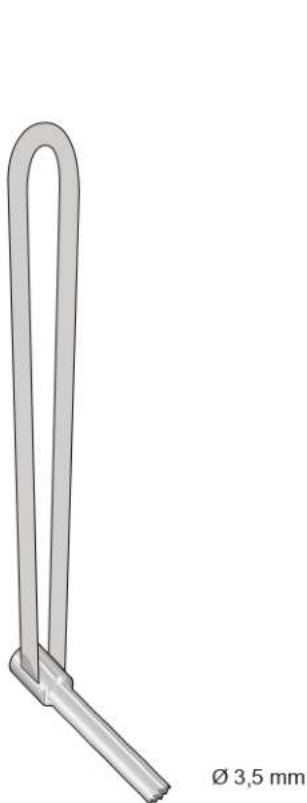
Centratori guida punte - Drill guides - Bohrbüchsen zu Knochenplatten - Guide méche



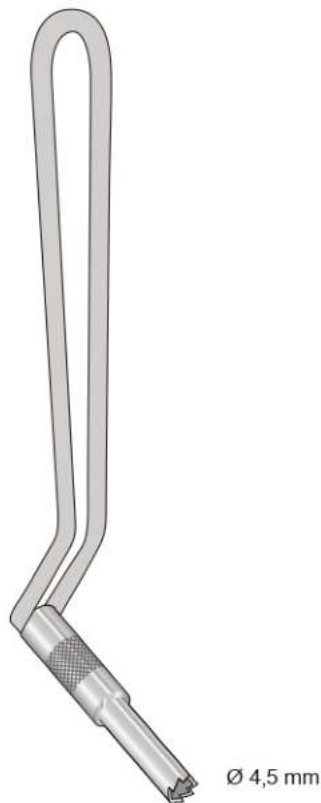
ST-6858-1
125 mm



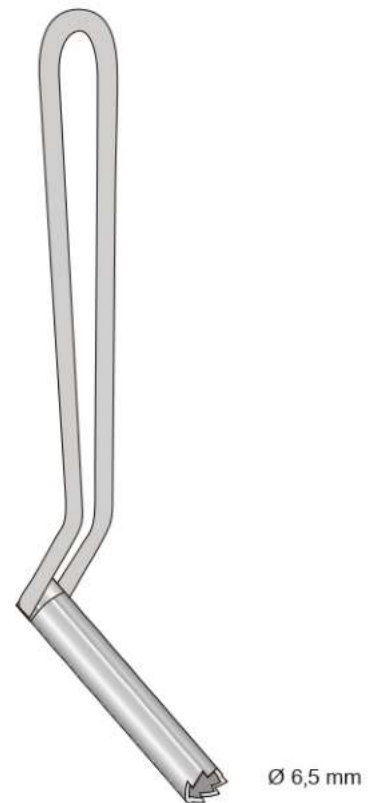
ST-6858-2
125 mm



ST-6858-3
125 mm

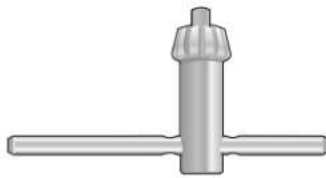
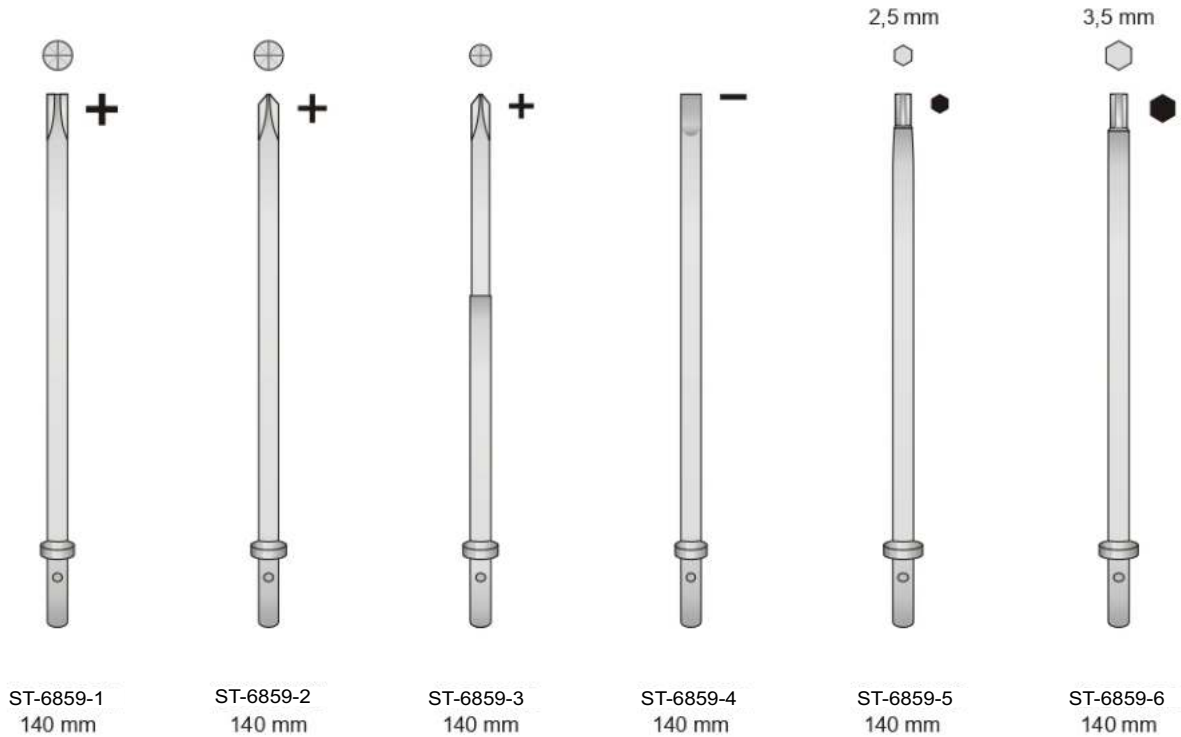


ST-6858-4
150 mm



ST-6858-5
150 mm

Scatola con set giraviti - Box with screws driver - Schraubenzieher, Set mit Etui
Jeu de tournevis, en boîte - Set destornilladores



ST-6860
32 mm

Scatola con set giraviti - Completo
Box with screws driver - Complete
Schraubenzieher, Set mit Etui - Komplett
Jeu de tournevis, en boîte - Complete
Set destornilladores - Completos



ST-6861
145 mm

Max. Ø 6,3 mm



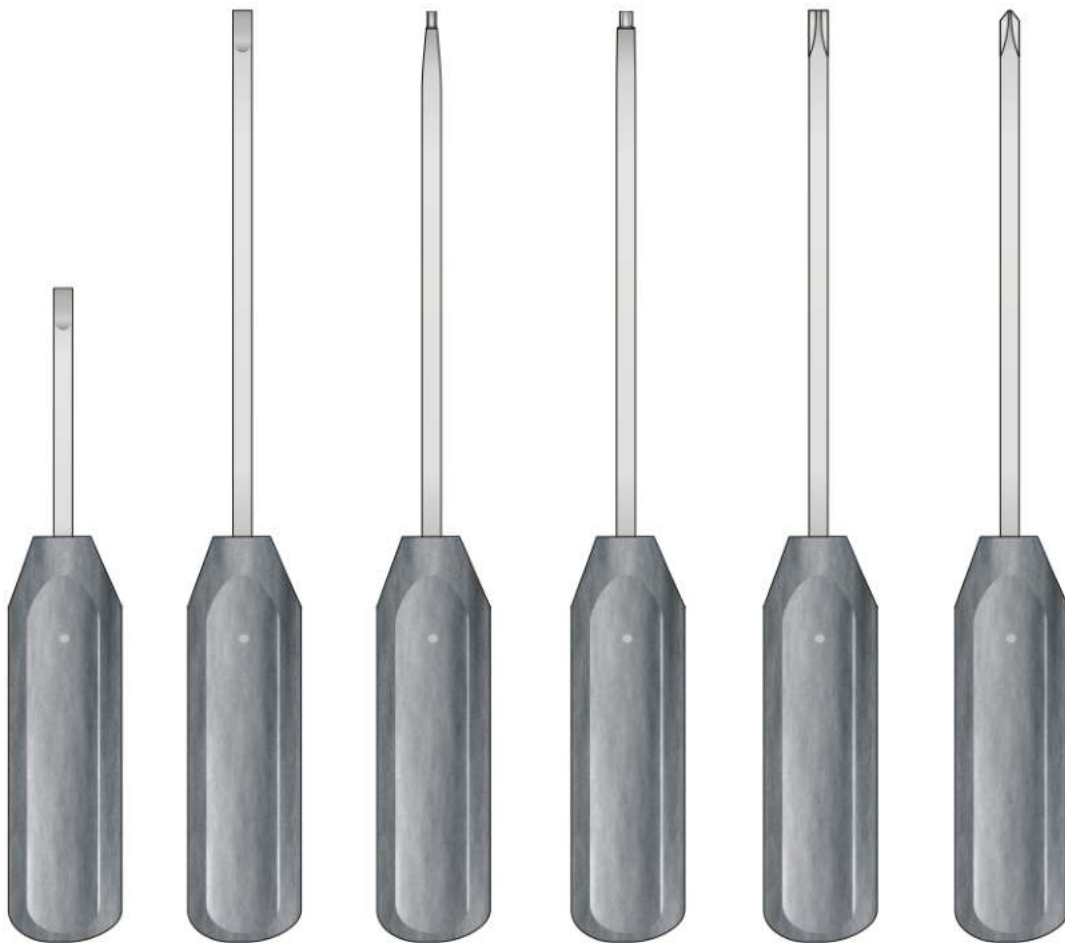
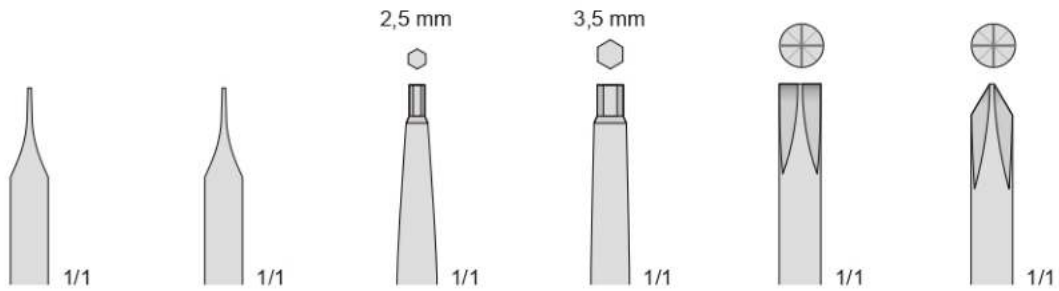
UNIVERSAL
ST-6862
75 mm



Solo scatola
ST-6863
200x100x40 mm



Giraviti - Screws driver - Schraubenzieher - Jeu de tournevis - Destornilladores



ST-6864-1
170 mm

LANE
ST-6864-2
250 mm

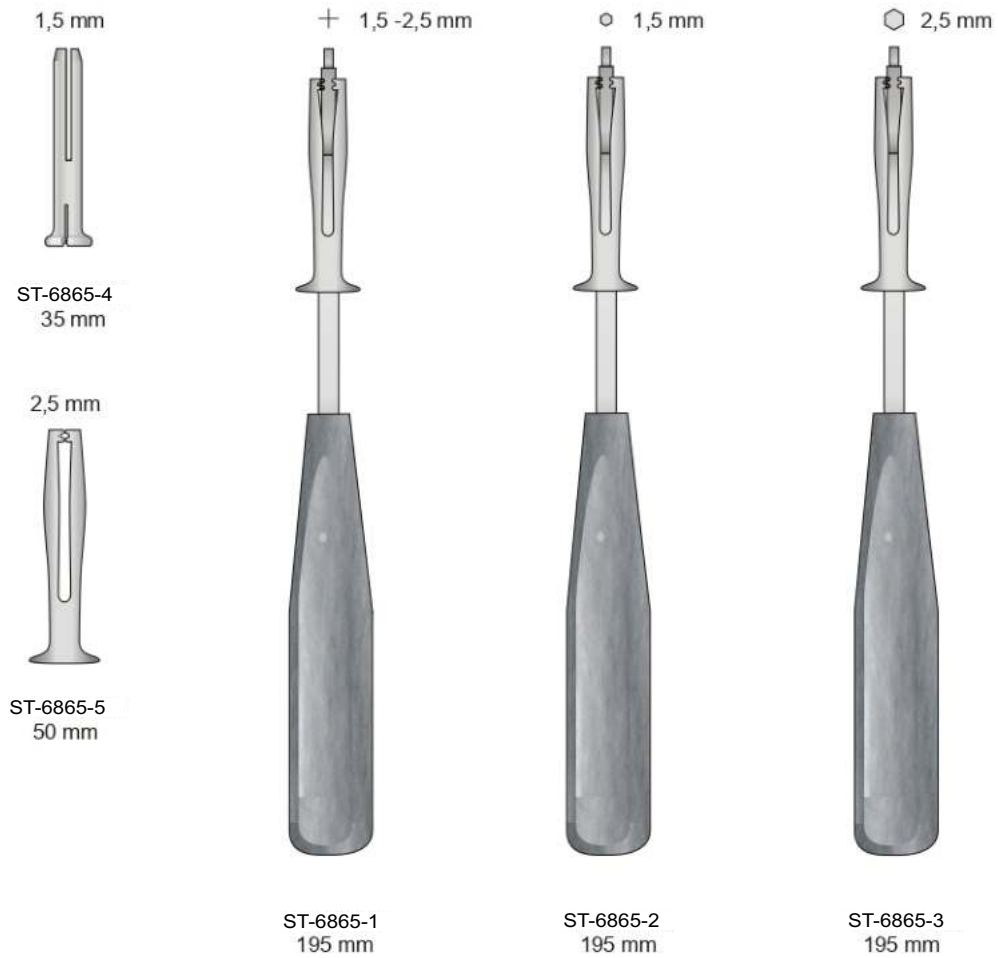
ST-6864-3
250 mm

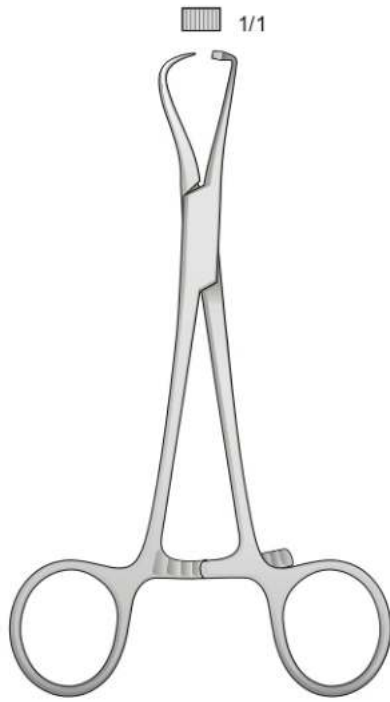
ST-6864-4
250 mm

ST-6864-5
250 mm

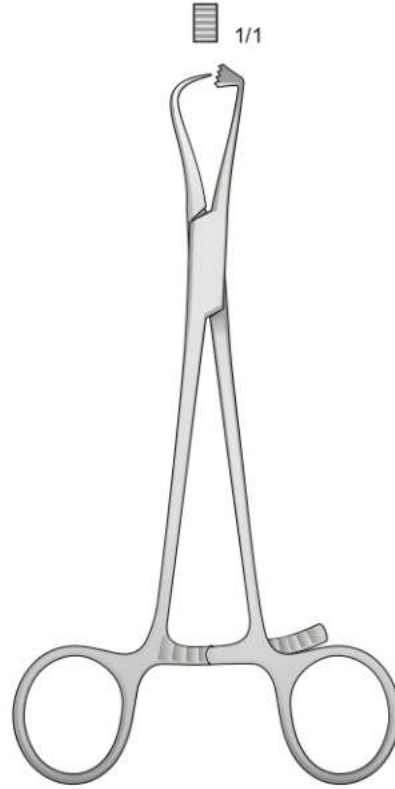
PHILIPS
ST-6864-6
250 mm

Giraviti - Screws driver - Schraubenzieher - Jeu de tournevis - Destornilladores

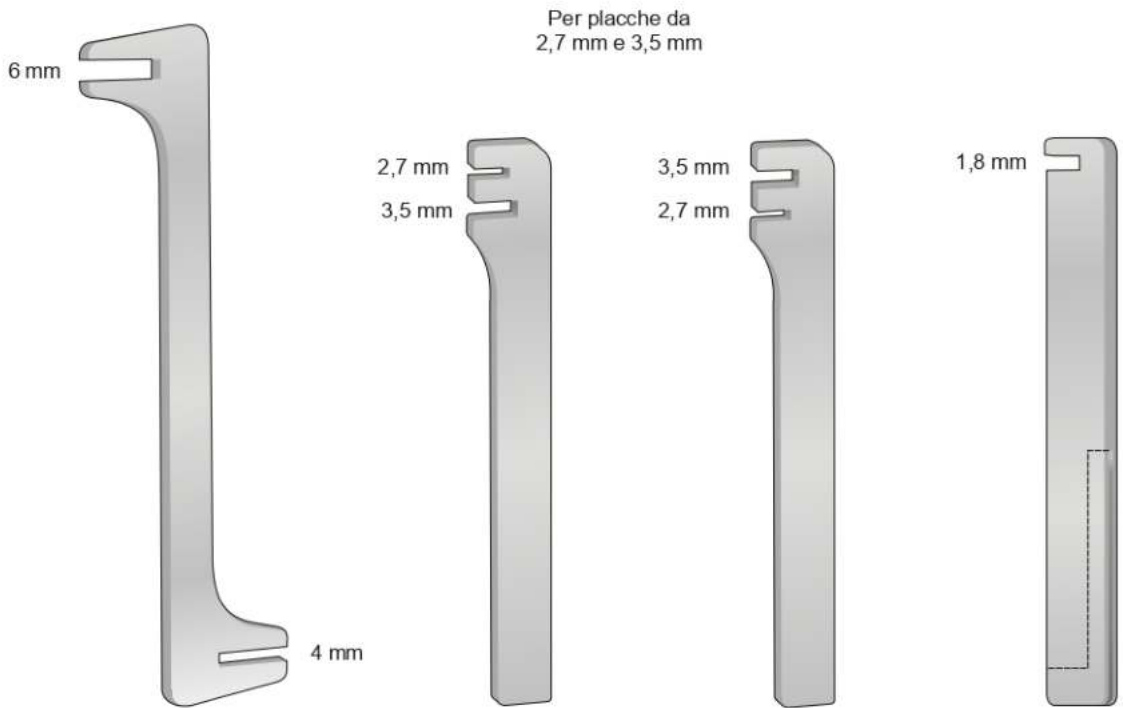




ST-6866
120 mm



ST-6867
125 mm



ST-6868
180 mm

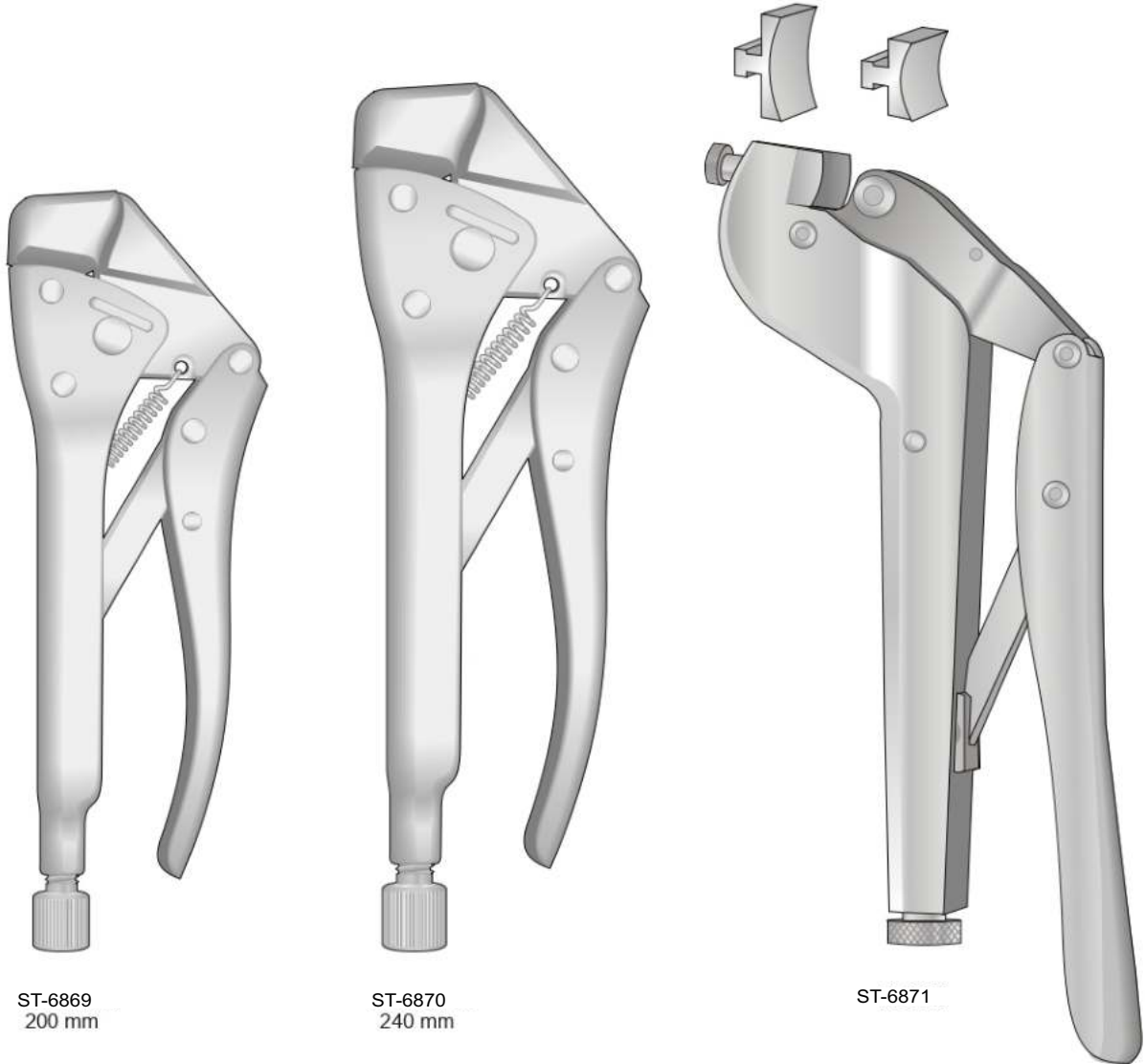
ST-6868-1 100 mm
ST-6868-2 140 mm

ST-6868-3 100 mm
ST-6868-4 140 mm

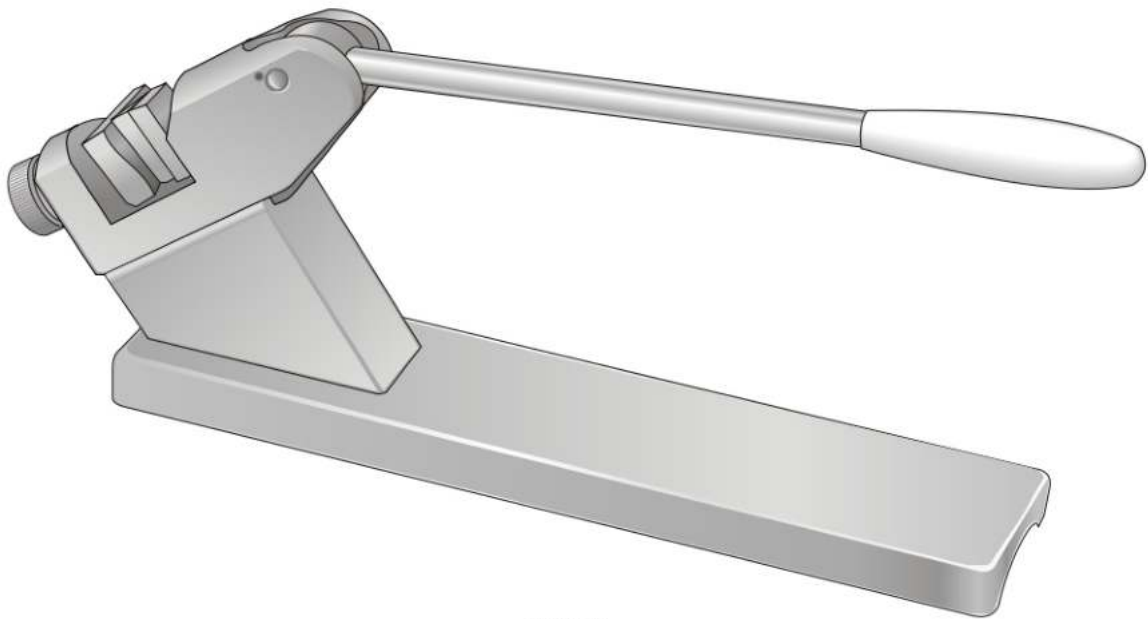
ST-6868-5
100 mm



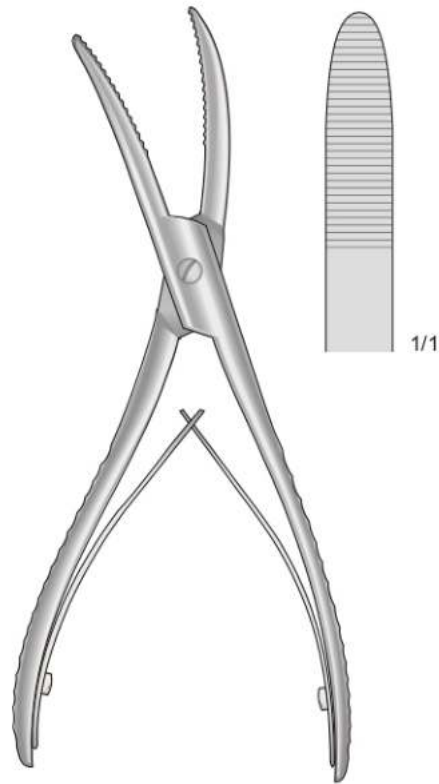
Pinze piegaplacche - Bending pliers - Biegezange - Pincés à plier



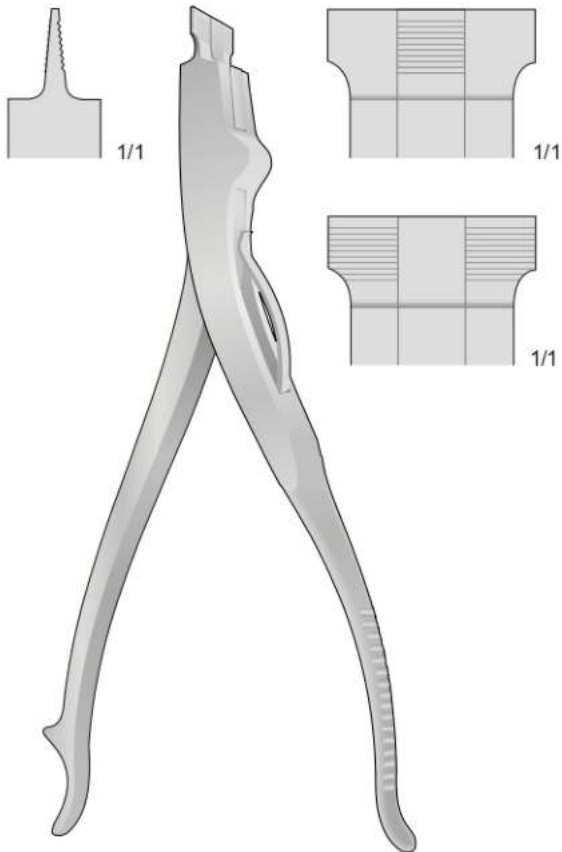
Pressa piegaplacche - Bending press - Biegepresse - Presse pour plier



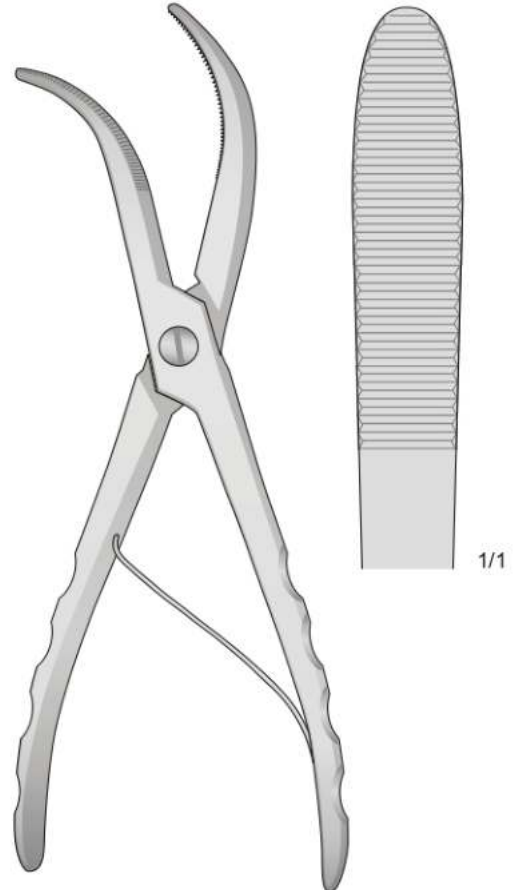
ST-6872



WOLFF
ST-6873
180 mm



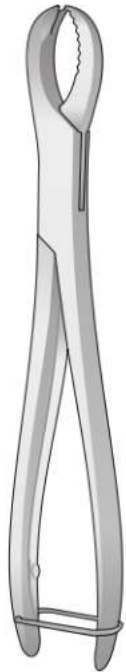
LAWTON
ST-6874
220 mm



WOLFF
ST-6875
250 mm



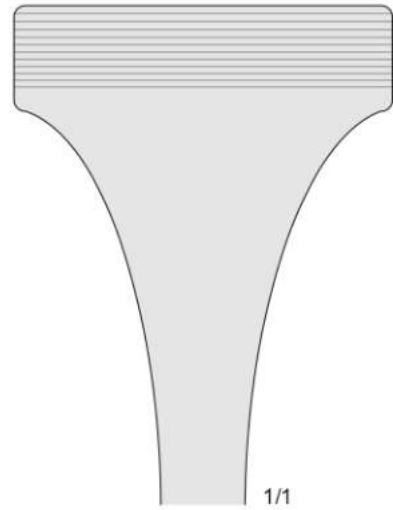
Cesoie per gesso
Gips - Schneidezangen



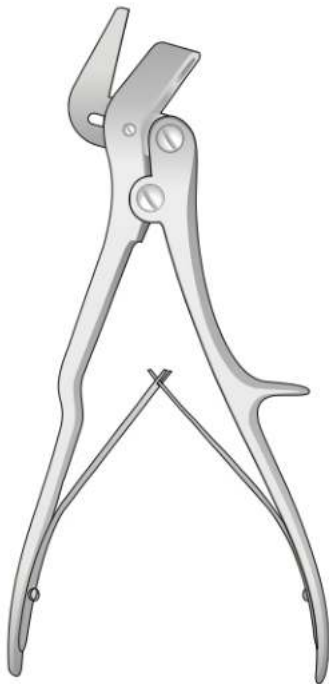
ST-6876
210 mm



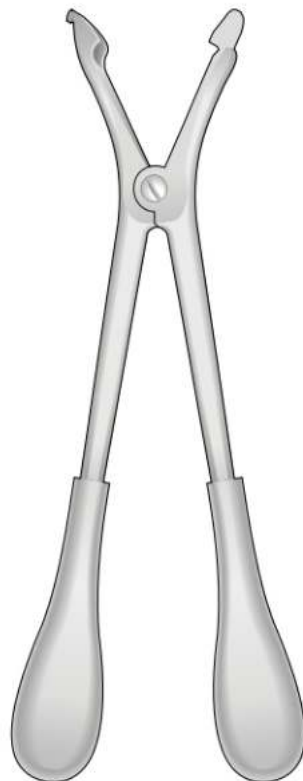
HENNIG
ST-6877
270 mm



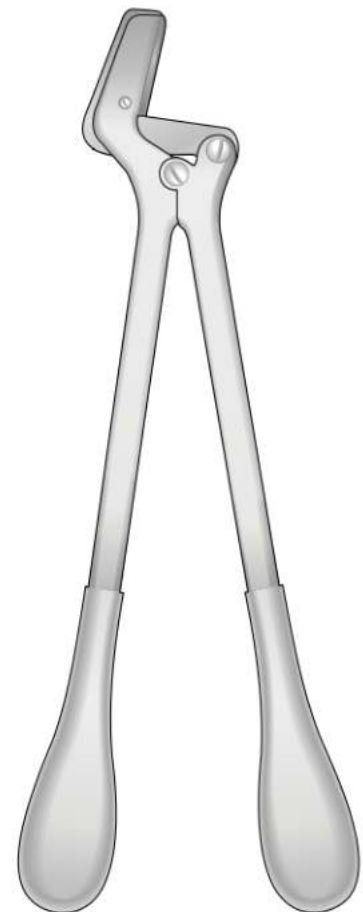
1/1



STILLE
ST-6878
230 mm



HAGLUND
ST-6879
280 mm

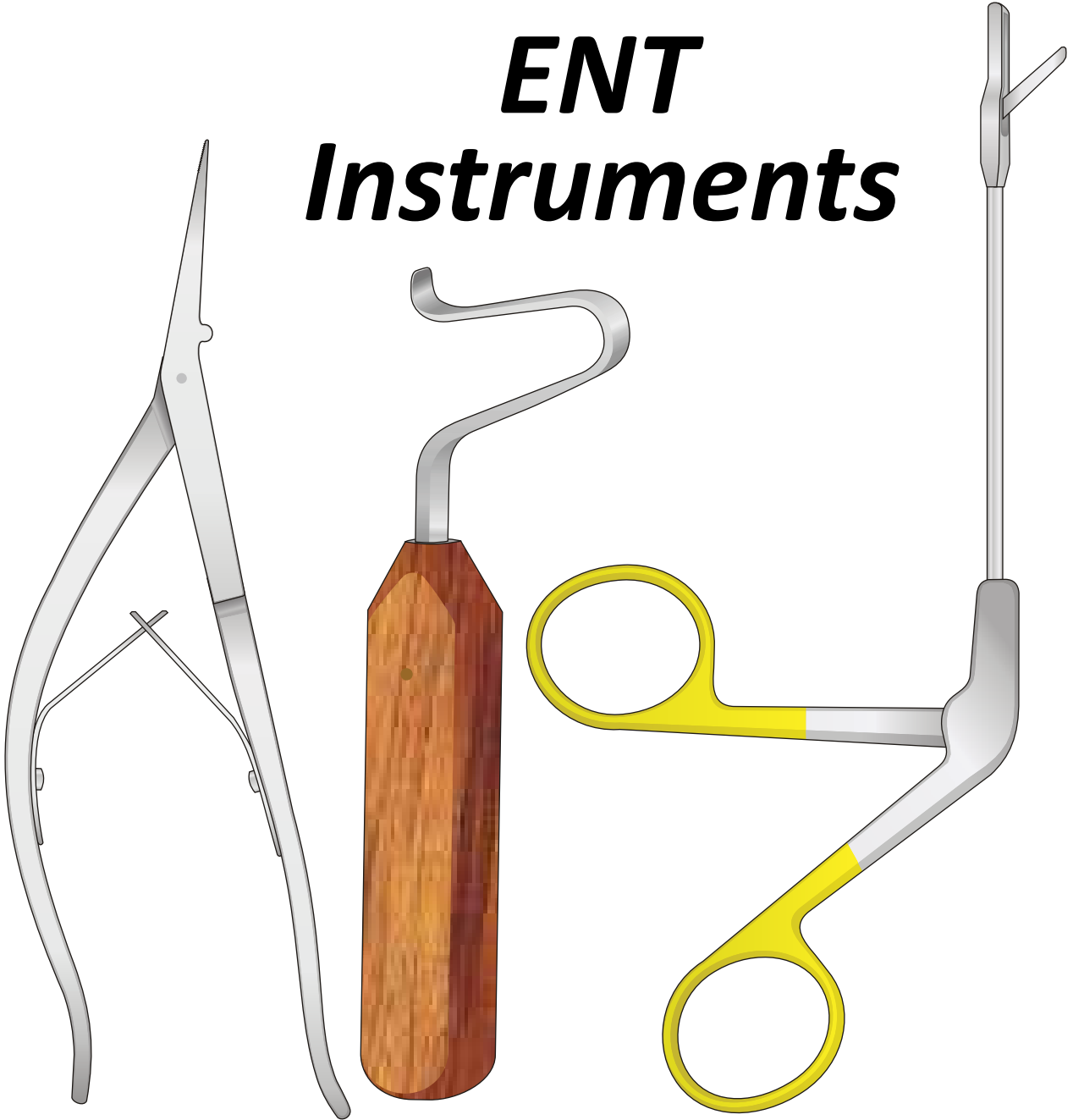


STILLE
ST-6880
370 mm



SAFE TOOL
MANUFACTURER & EXPORTER

ENT Instruments

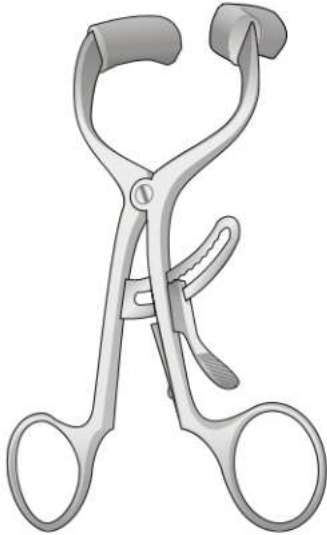


www.safetool.com.pk

*Surgical
Instruments*

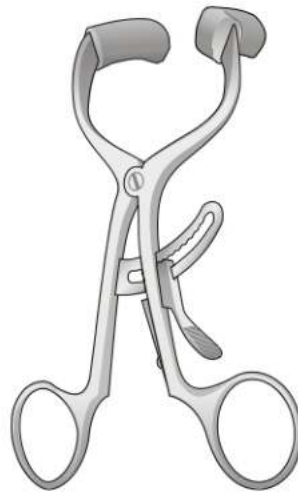


Per adulti - For adults
Für Erwachsene - Pour adultes
Para adultos



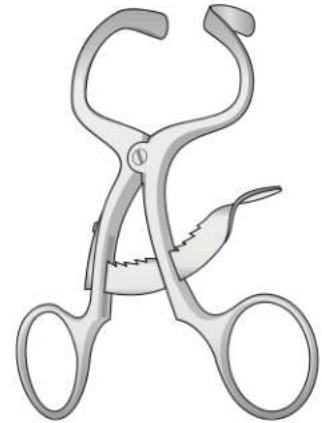
DOYEN-JANSEN
ST-8001
140 mm

Per adulti - For adults
Für Erwachsene - Pour adultes
Para adultos

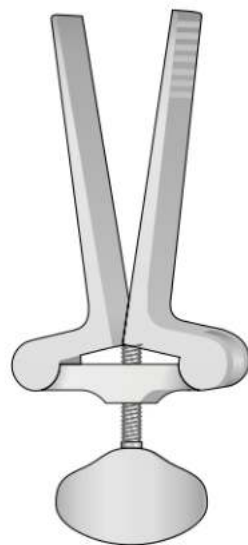


DOYEN-COLLIN
ST-8002
120 mm

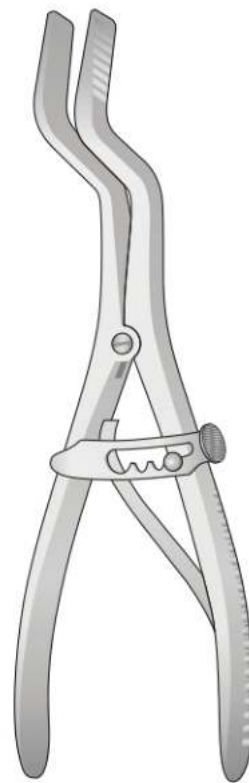
Per bambini
For children
Für kinder
Pour enfants
Para niños



MOLT
ST-8003
100 mm



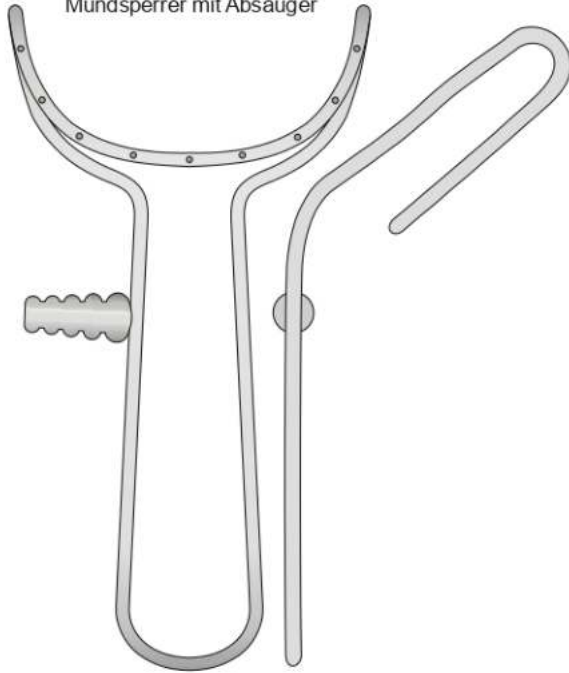
HEISTER
ST-8004
135 mm



ROSER KÖNIG
ST-8005
185 mm

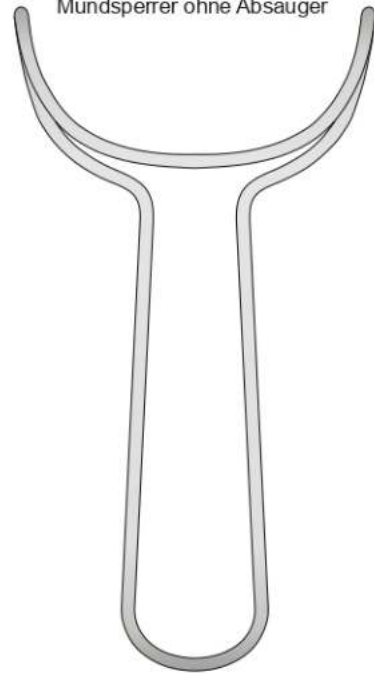


Apribocca con aspirazione
Mouth gag with suction
Mundsperrerr mit Absauger

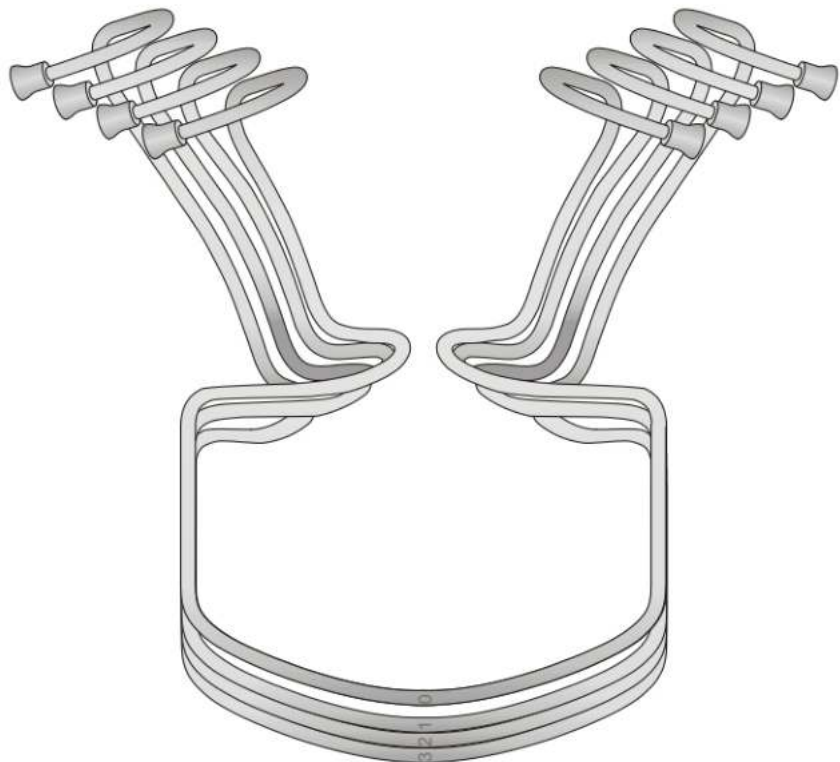
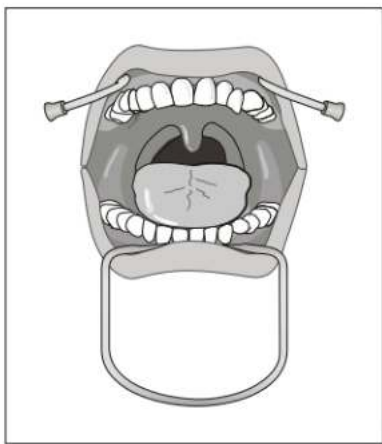


ST-8006
140 mm

Apribocca senza aspirazione
Mouth gag without suction
Mundsperrerr ohne Absauger

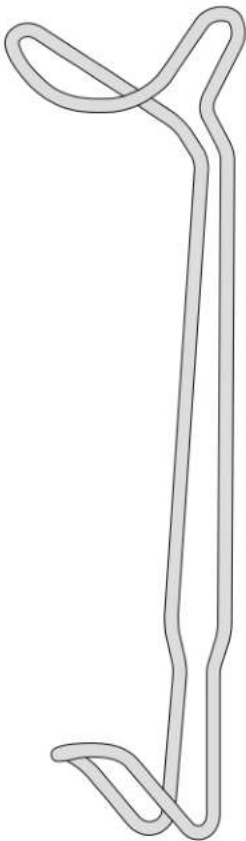


ST-8007
150 mm

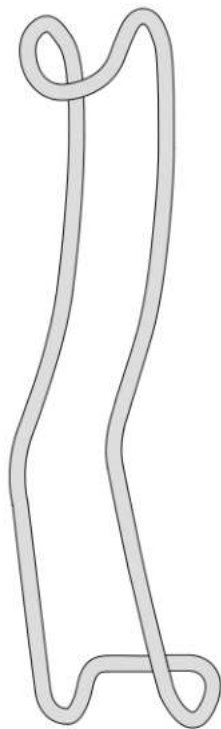


ORINGER

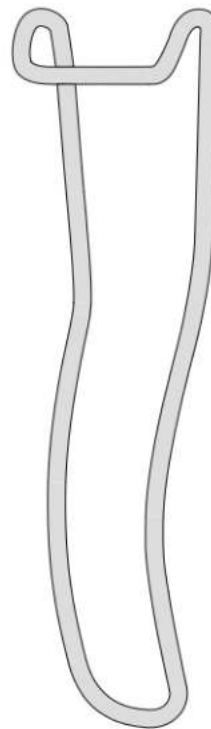
ST-8008	Fig. 0	100 x 95 mm	Per bambini
ST-8009	Fig. 1	115 x 105 mm	Per adulti
ST-8010	Fig. 2	115 x 110 mm	Per adulti
ST-8011	Fig. 3	125 x 115 mm	Per adulti



ST-8012
210 mm



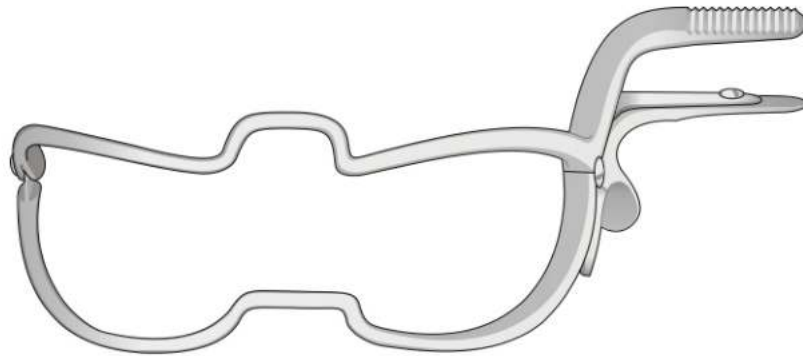
STERNBERG
ST-8013
160 mm



STERNBERG
ST-8014
160 mm



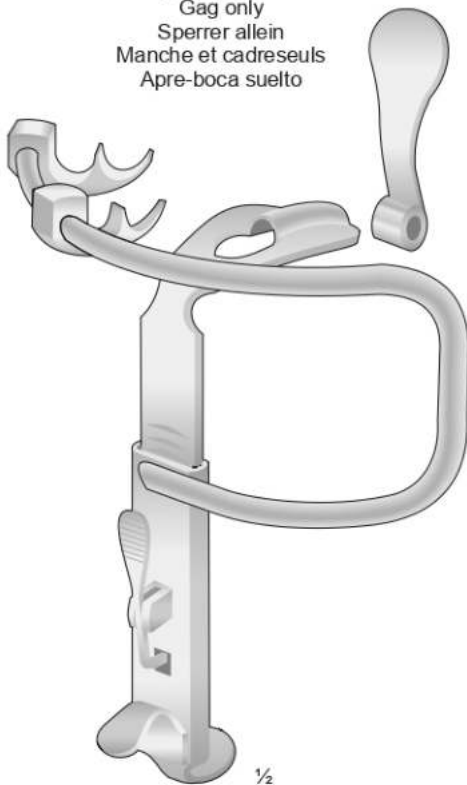
MINNESOTA
ST-8015
140 mm



WHITEHEAD-JENNINGS

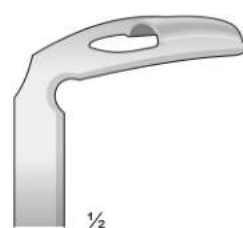
- ST-8016 90 mm
- ST-8017 110 mm
- ST-8018 130 mm
- ST-8019 150 mm

Apribocca solo
Gag only
Sperrer allein
Manche et cadreseuls
Apre-boca suelto



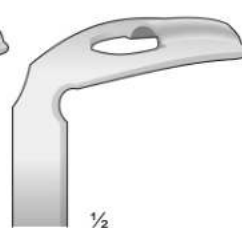
KILNER-DOUGHTY
ST-8023

Fig. 1



ST-8020
8 x 65 mm

Fig. 2



ST-8021
32 x 75 mm

Fig. 3



ST-8022
37 x 80 mm

KILNER-DOUGHTY
13-220

Completo con 3 abbassalingua
Complete with 3 tongue depressors
Komplet mit 3 Zungenspatel
Complet avec 3 abaisse-langues
Completo con 3 abaja lengua

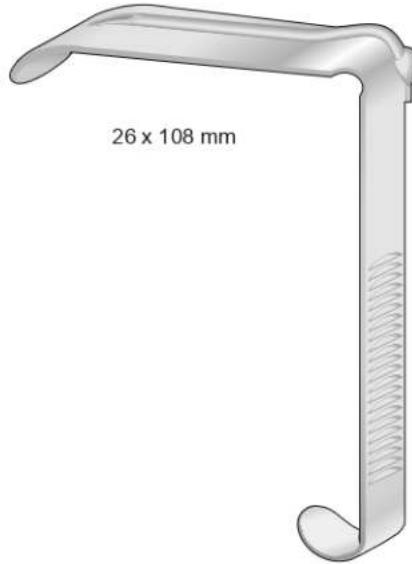


Apribocca solo
Gag only
Sperrer allein
Manche et cadreseuls
Apre-boca suelto



DAVIS-BOYLE
ST-8023-1

DAVIS-BOYLE
13-240
Completo con 5 abbassalingua
Complete with 5 tongue depressors
Komplet mit 5 Zungenspatel
Complet avec 5 abaisse-langues
Completo con 5 abaja lengua



26 x 108 mm

ST-8023-2



13-230-02
25 x 93 mm



ST-8023-3
24 x 80 mm

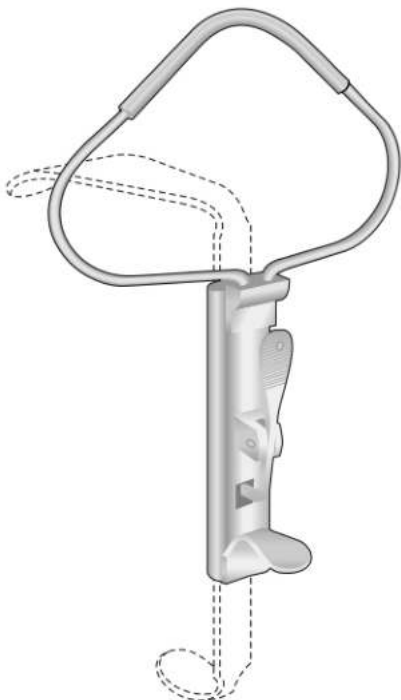


ST-8023-4
23 x 65 mm



ST-8023-5
21 x 30 mm

Mc-IVOR
13-260
Completo di 3 abbassalingua
Complete with 3 tongue depressors
Komplet mit 3 Zungenspatel
Complet avec 3 abaisse-langues
Completo con 3 abaja lengua



Mc-IVOR
ST-8024-1

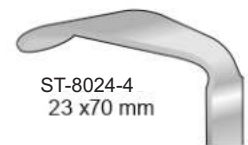


26 x 100 mm

ST-8024-2

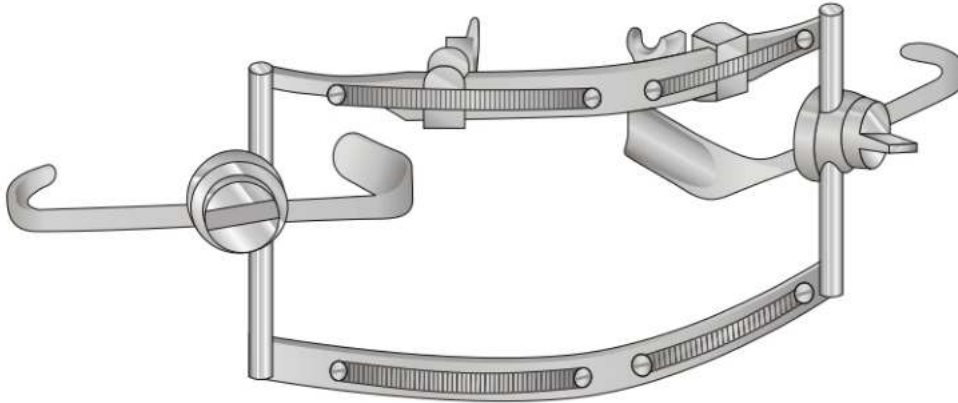


ST-8024-3
25 x 86 mm



ST-8024-4
23 x 70 mm

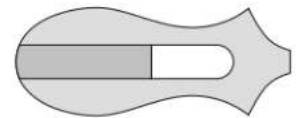
Telaio Dingmann con
due apriguancia



ST-8025-1

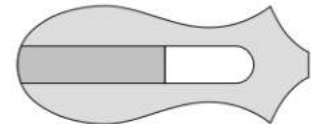
Abbassalingua
Tongue depressor
Zungenspatel
Abaisse langues
Bejalenguas

Fig. 1



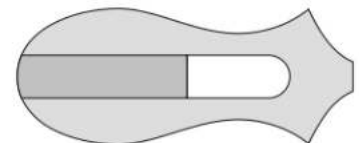
ST-8025-2
piccolo

Fig. 2

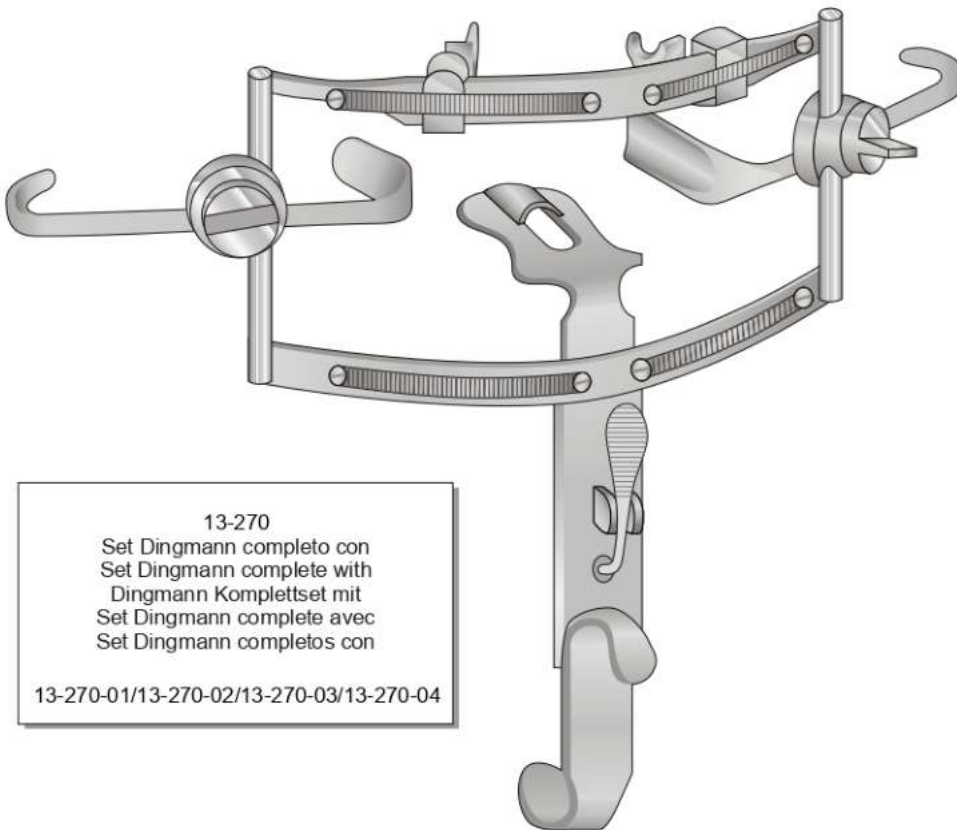


ST-8025-3
medio

Fig. 3



ST-8025-4
grande



13-270
Set Dingmann completo con
Set Dingmann complete with
Dingmann Kompletset mit
Set Dingmann complete avec
Set Dingmann completos con

13-270-01/13-270-02/13-270-03/13-270-04

DINGMANN
ST-8025
Set completo



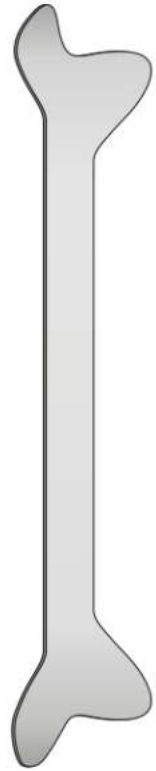
ST-8026-1
110 mm



ST-8026-2
160 mm



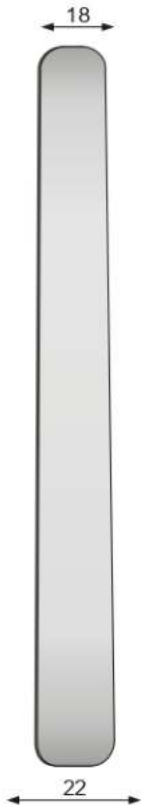
ST-8027
195 mm



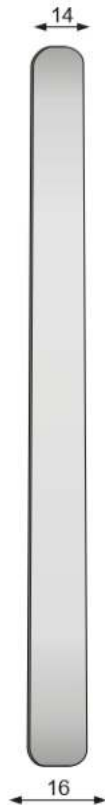
ST-8028
180 mm

Spatole inox malleabili
Spatulas malleable

Spatole Inox malleabili antiriflesso nere
Spatulas malleable black anodized



ST-8028-1
200 mm



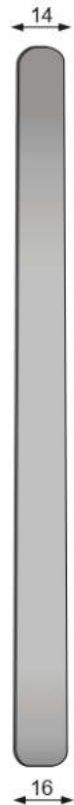
ST-8028-2
200 mm



ST-8028-3
240 mm



ST-8028-4
200 mm



ST-8028-5
200 mm

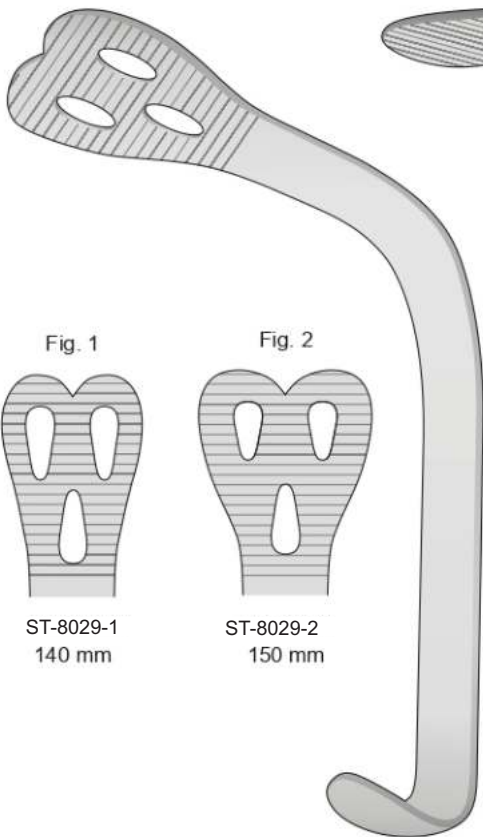
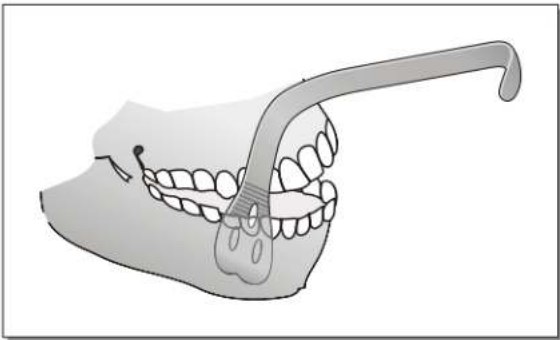


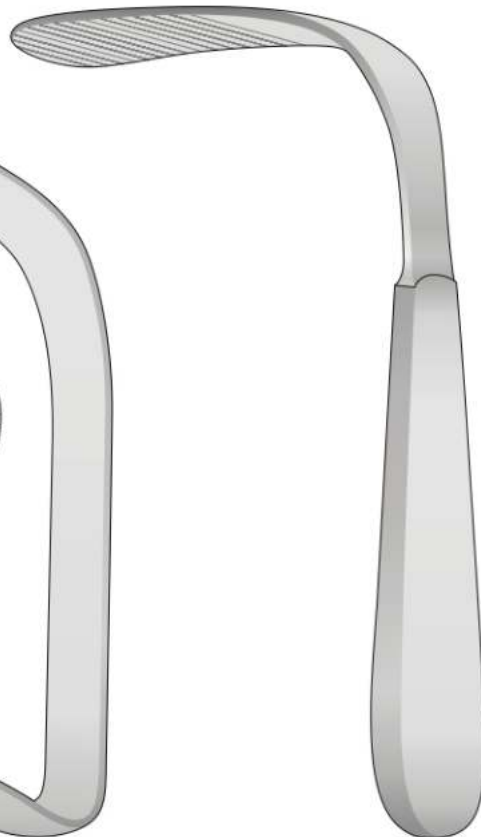
Fig. 1

Fig. 2

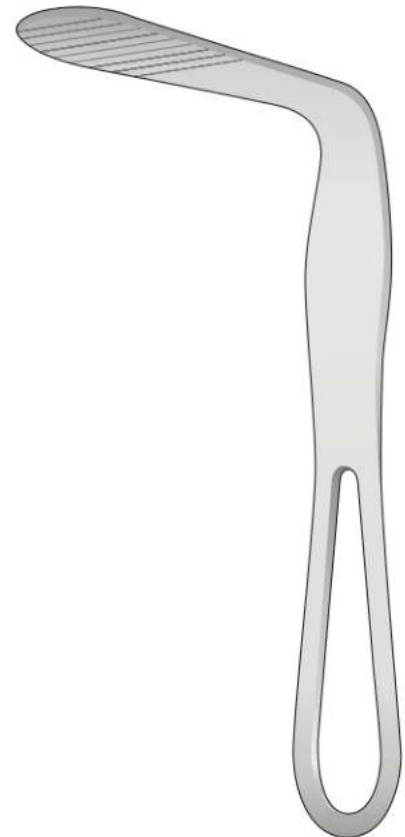
ST-8029-1
140 mm

ST-8029-2
150 mm

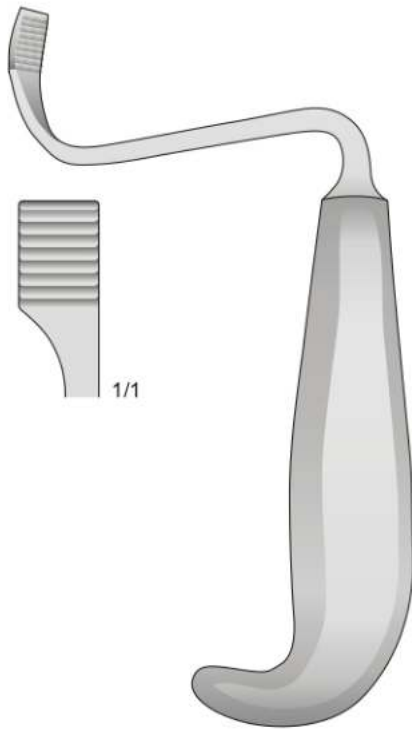
WIEDER
ST-8029



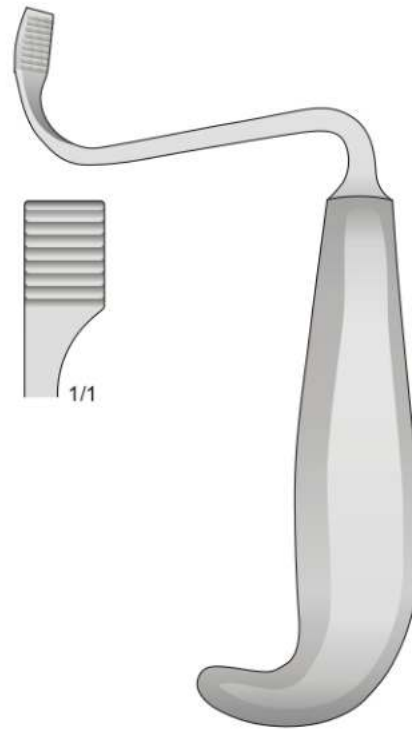
TOBOLD
ST-8030
145 mm



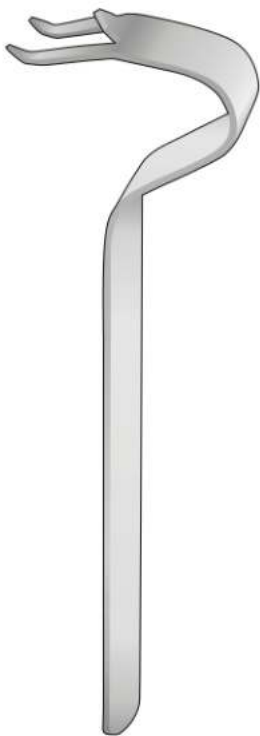
HARTMANN
ST-8031
150 mm



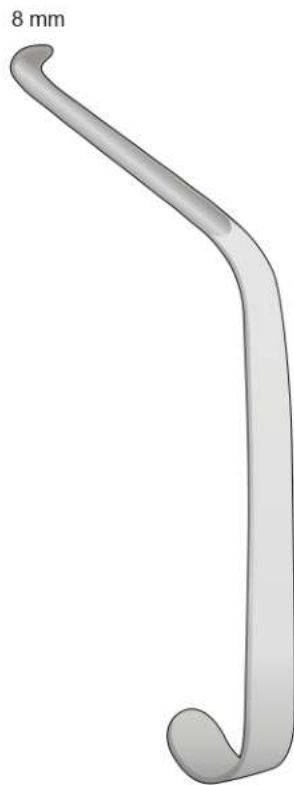
TESSIER
ST-8032-1
150 mm



TESSIER
ST-8032-2
150 mm



OBWEGESER
ST-8033
155 mm



OBWEGESER
ST-8034-1
165 mm



OBWEGESER
ST-8034-2
165 mm



6 x 13 mm



DUNN-DAUTREY
ST-8035-1
130 mm

8 x 18 mm



DUNN-DAUTREY
ST-8035-2
125 mm

Posteriore



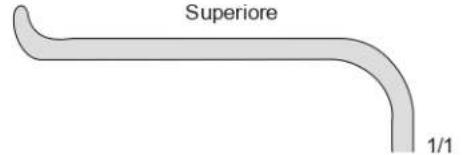
1/1

Anteriore

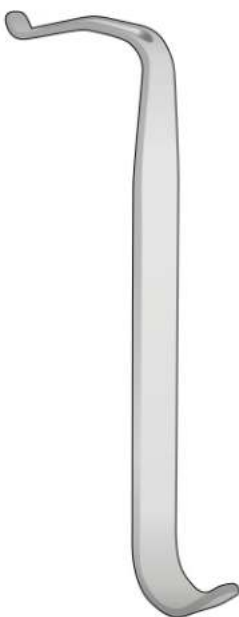


1/1

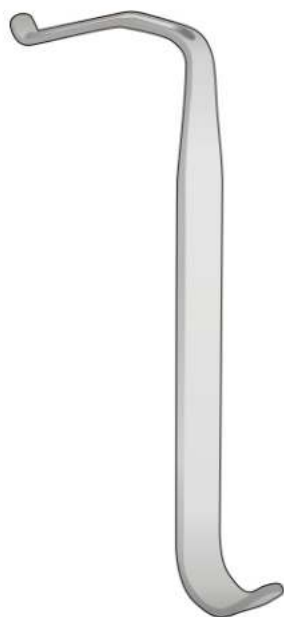
Superiore



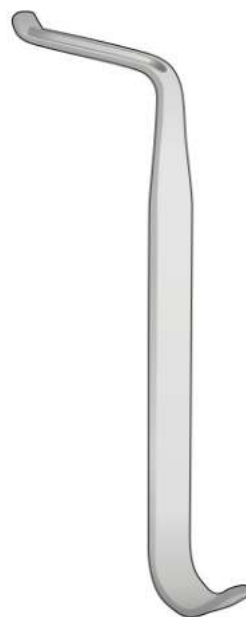
1/1



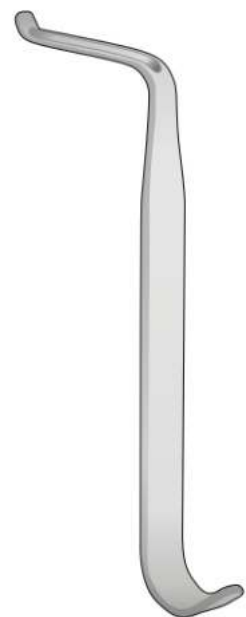
DUNN-DAUTREY
ST-8036-1 6,5 x 50 mm
140 mm



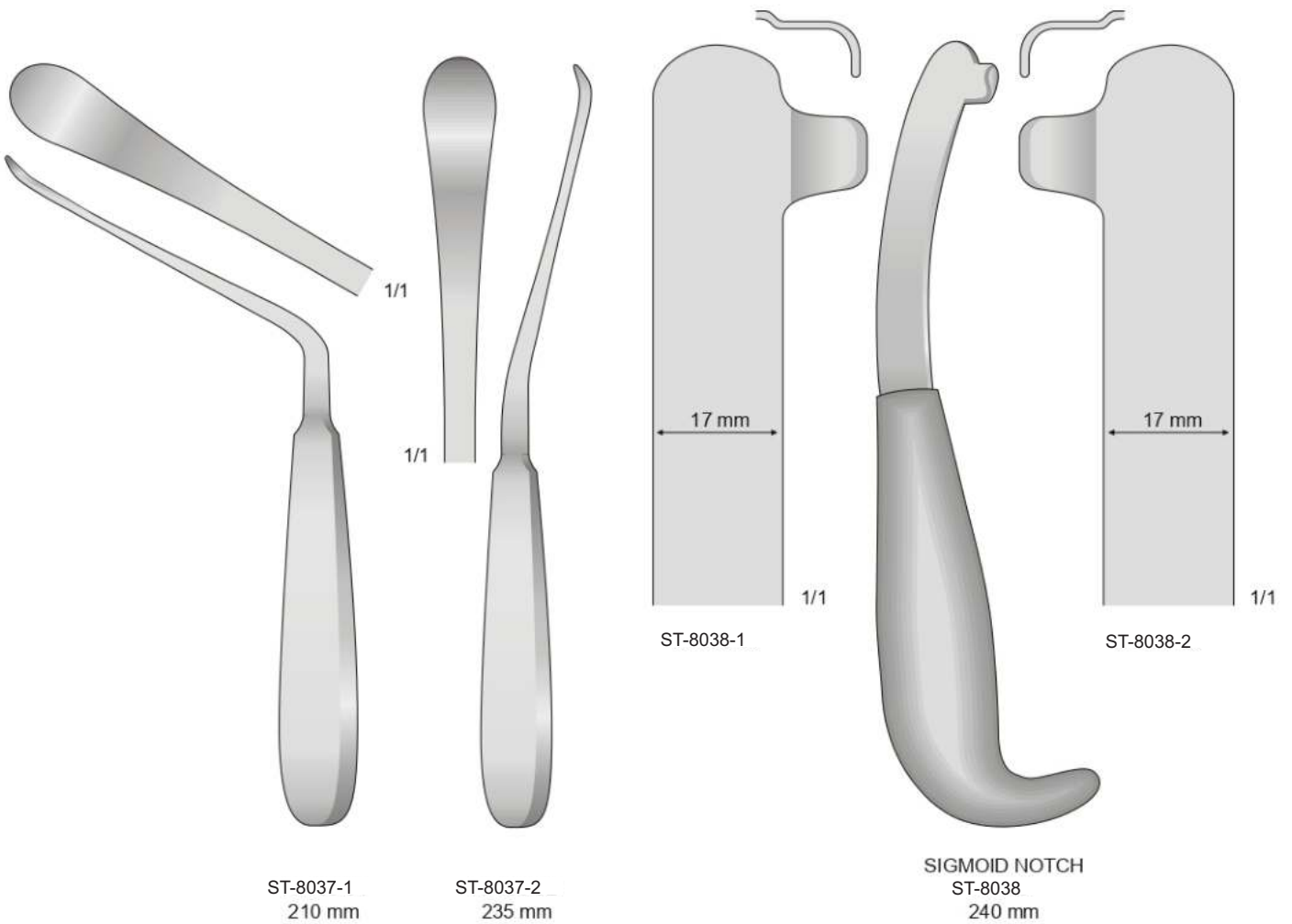
DUNN-DAUTREY
ST-8036-2 6,5 x 60 mm
140 mm

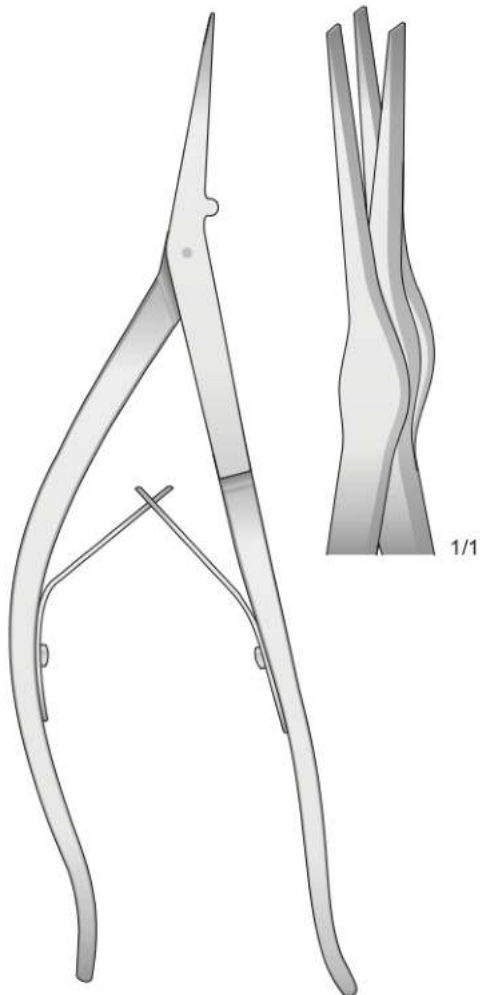
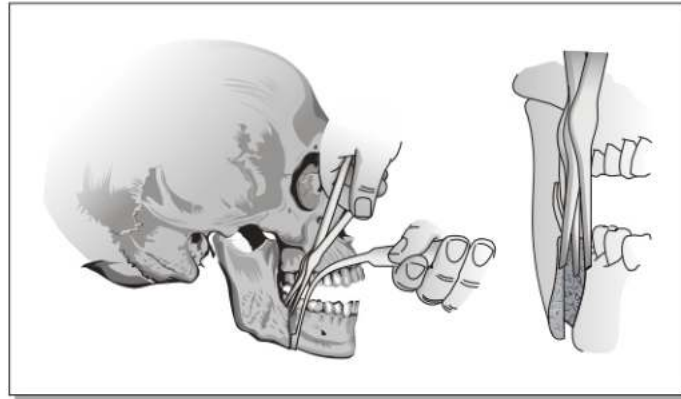


DUNN-DAUTREY
ST-8036-3 8 x 50 mm
140 mm

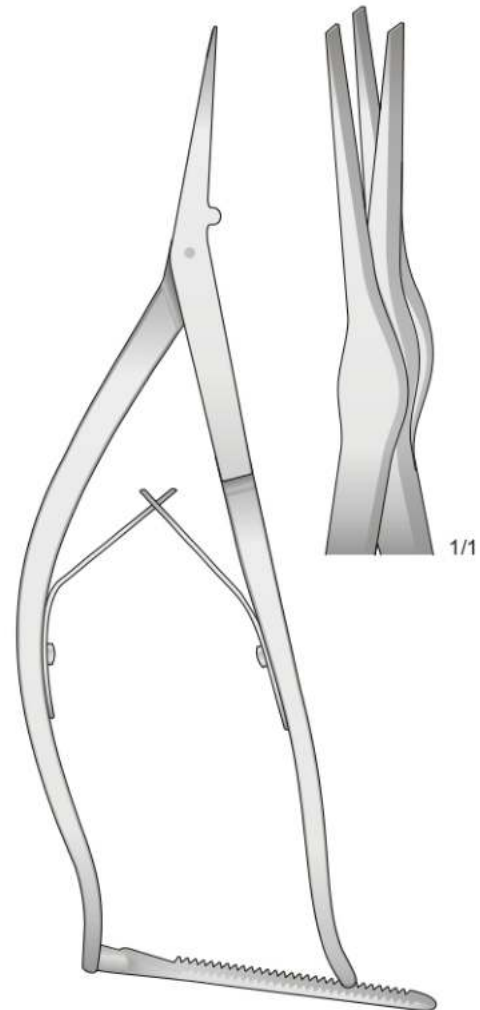


DUNN-DAUTREY
ST-8036-4 5 x 50 mm
140 mm

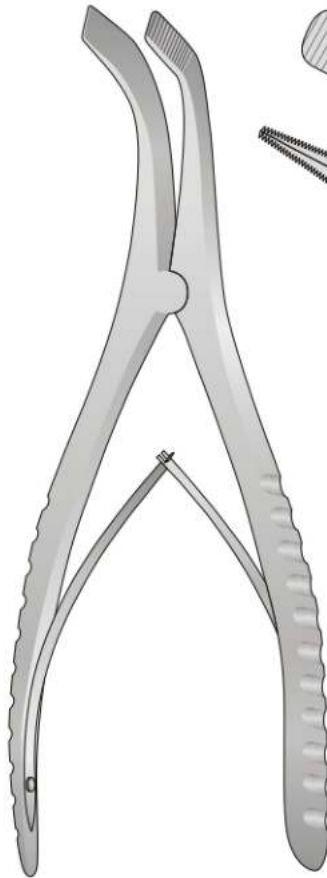
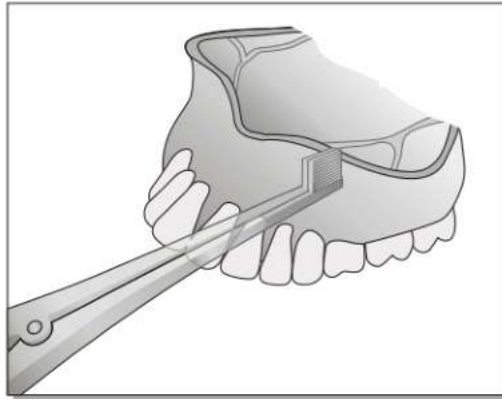




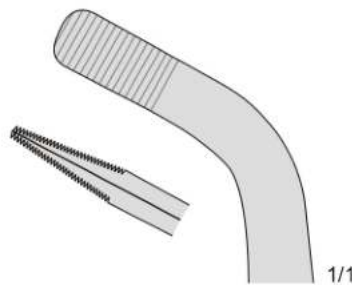
RAMUS
ST-8039
230 mm



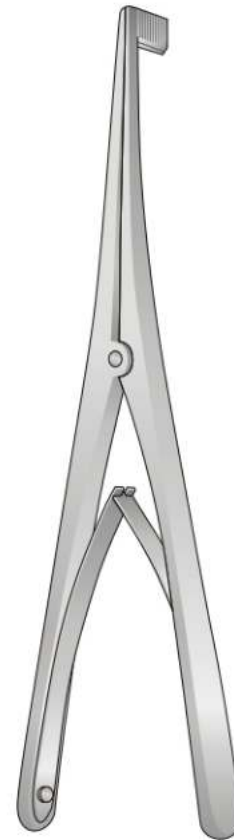
RAMUS
ST-8040
230 mm



TESSIER
ST-8041
180 mm

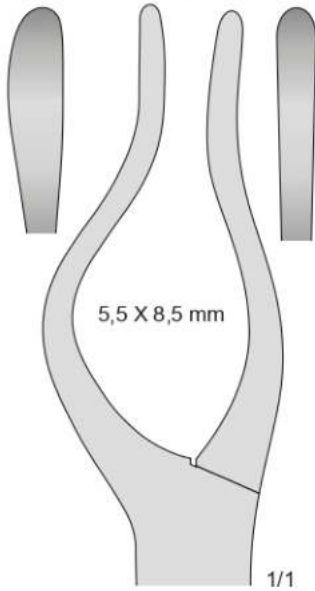


Maxillary expander



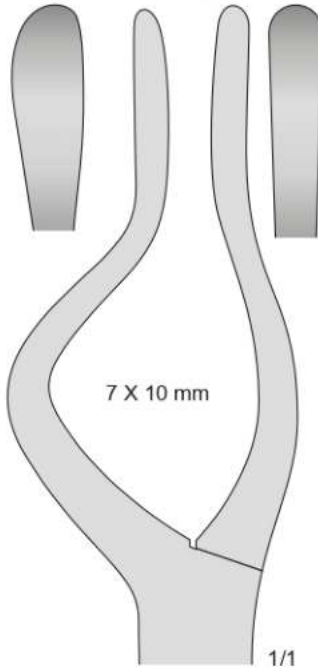
ST-8042
170 mm

Lattanti
For juveniles
Für Jugendliche



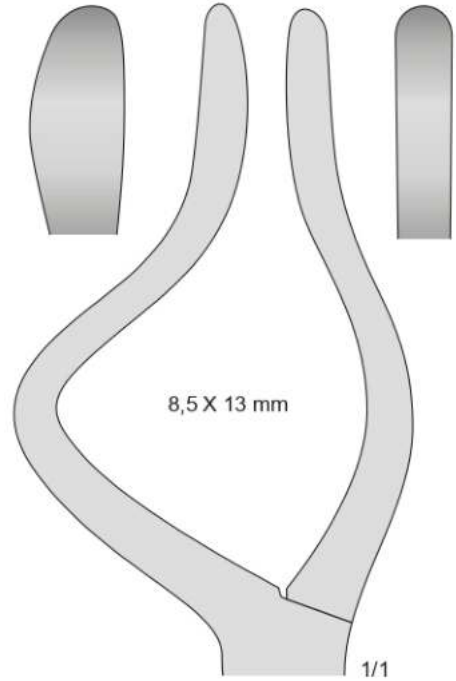
ST-8043-1
ST-8043-2
225 mm

Per bambini
For children
Für Kinder
Pour enfants
Para niños

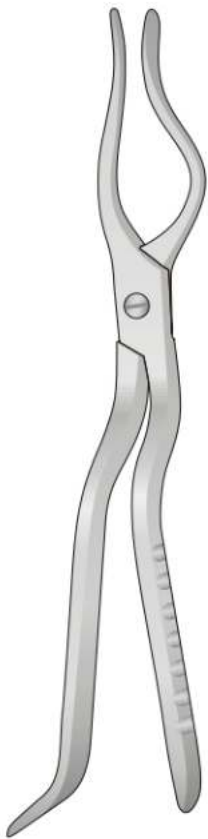


ST-8044-1
ST-8044-2
235 mm

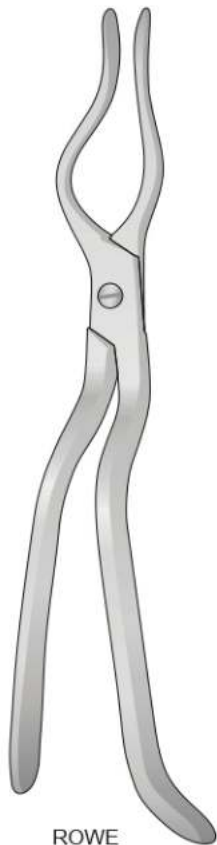
Per adulti
For adults
Für Erwachsene
Pour adultes
Para adultos



ST-8045-1
ST-8045-2
240 mm



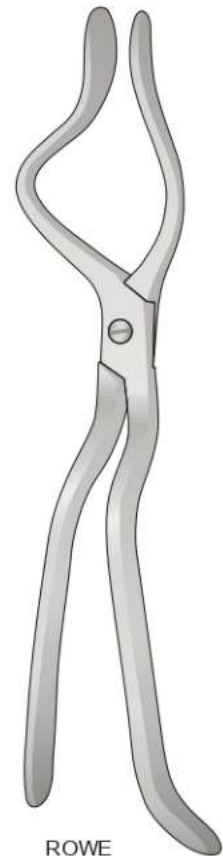
ROWE



ROWE



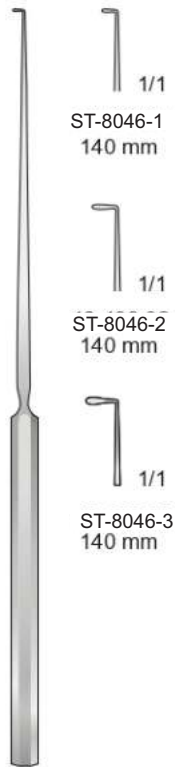
ROWE



ROWE

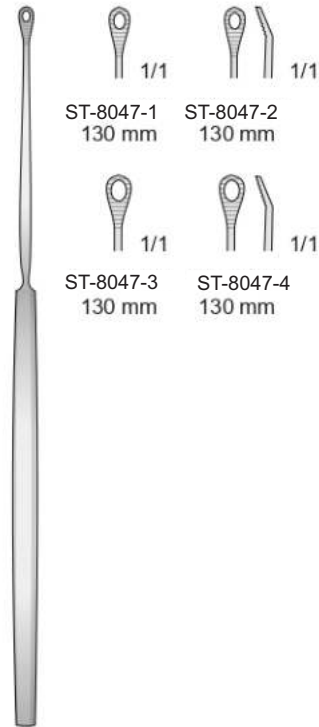


Uncini



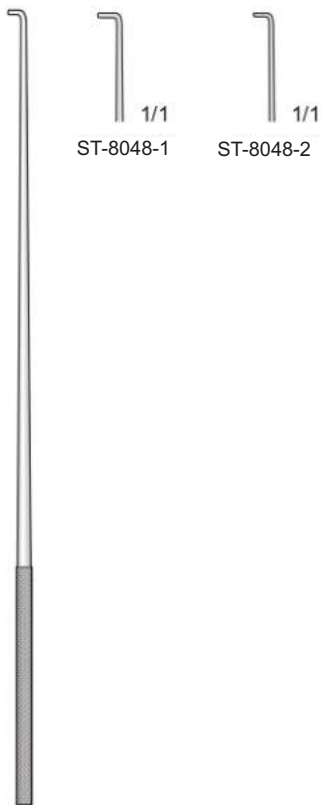
LUCAE
ST-8046
140 mm

Curette - Curettes - Löffel - Curettes - Curetas



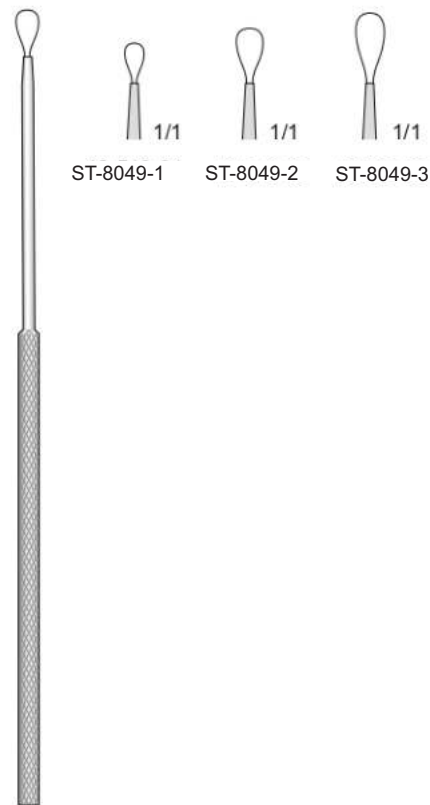
SHAPLEIGH
ST-8047
130 mm

Uncini

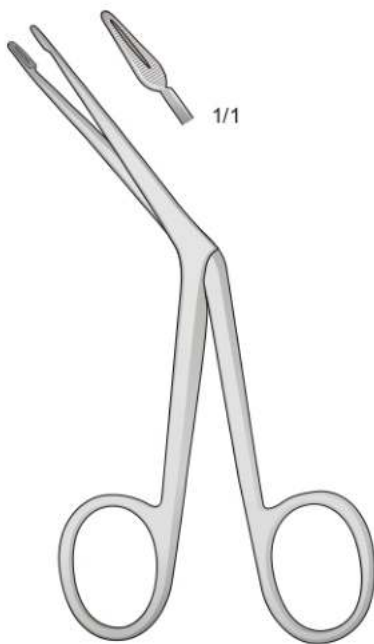
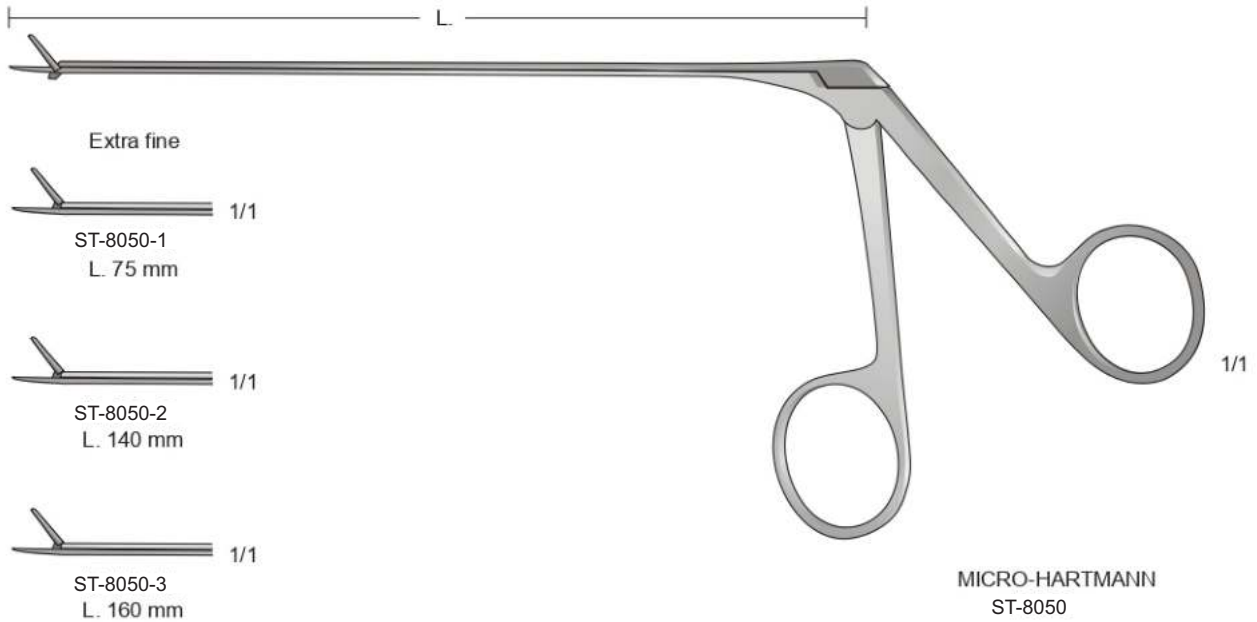


DAY
ST-8048
160 mm

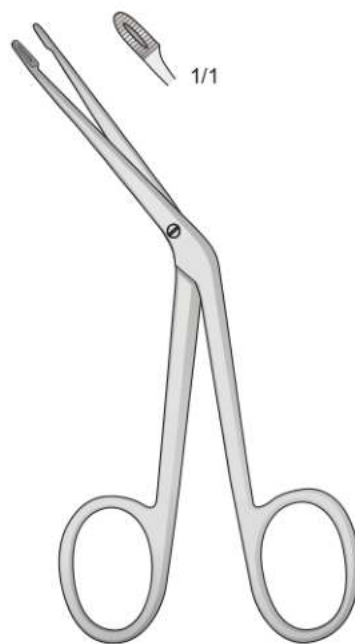
Anse auricolari - Ear loops anses - Ohrschlingen - Ansas auricolares



BILLEAU
ST-8049
160 mm



LITTAUER
ST-8051
120 mm



HARTMANN
ST-8052-1
120 mm



HARTMANN
ST-8052-2
140 mm



Pinze auricolari
Ear Forceps
Ohr-Polypenzangen
Pincès pour polypes auriculaires
Pinzas auricolares



ST-8053-1
L.85 mm



ST-8053-2
L.85 mm



ST-8053-3
L.85 mm



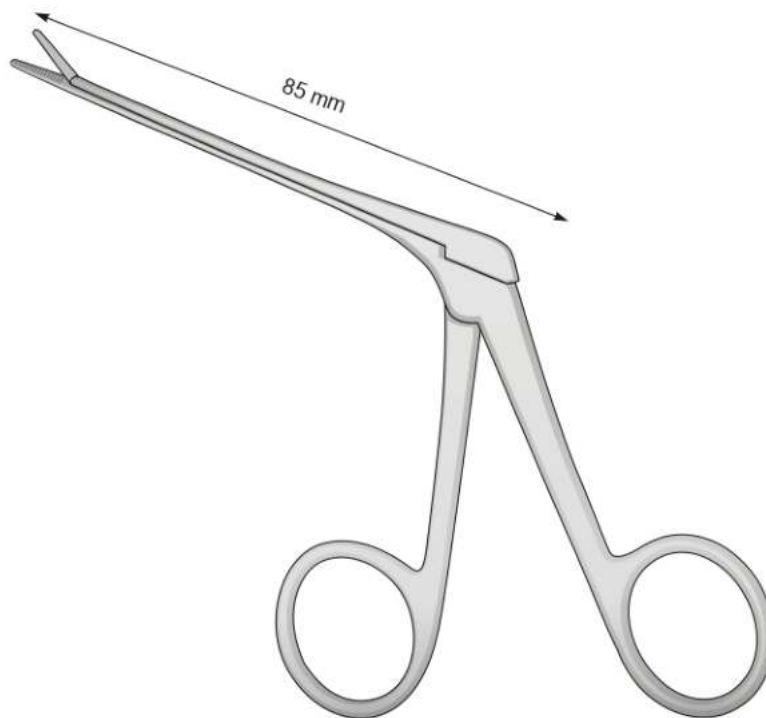
ST-8053-4
L.85 mm



ST-8053-5
L.85 mm

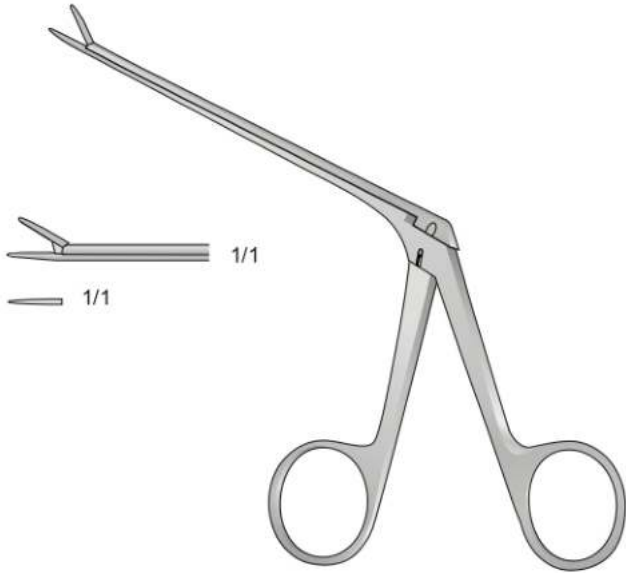


ST-8053-6
L.140 mm
13-550-07
L.165 mm

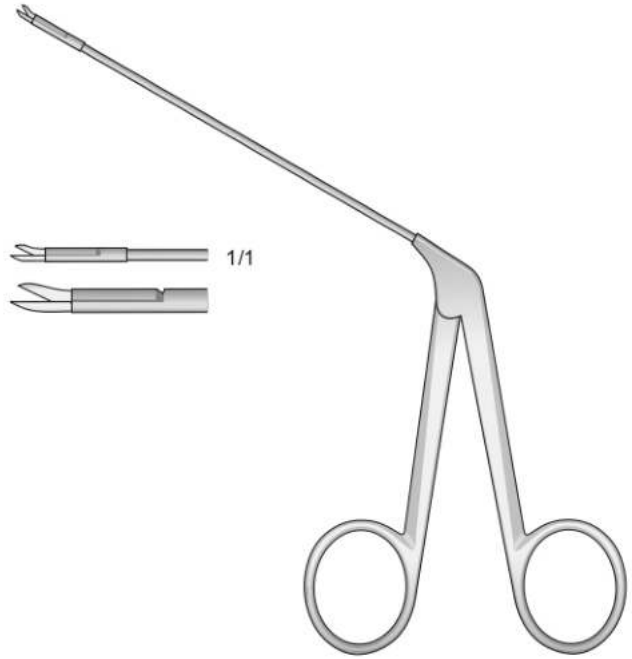


ST-8053
L. 85 mm

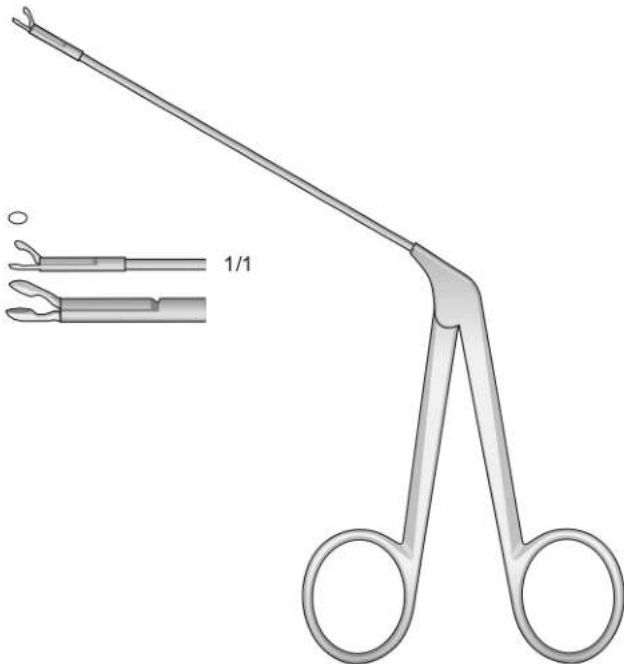
Micro forbice
Micro scissor
Mikro Scheren
Micro ciseaux
Micro tijeras



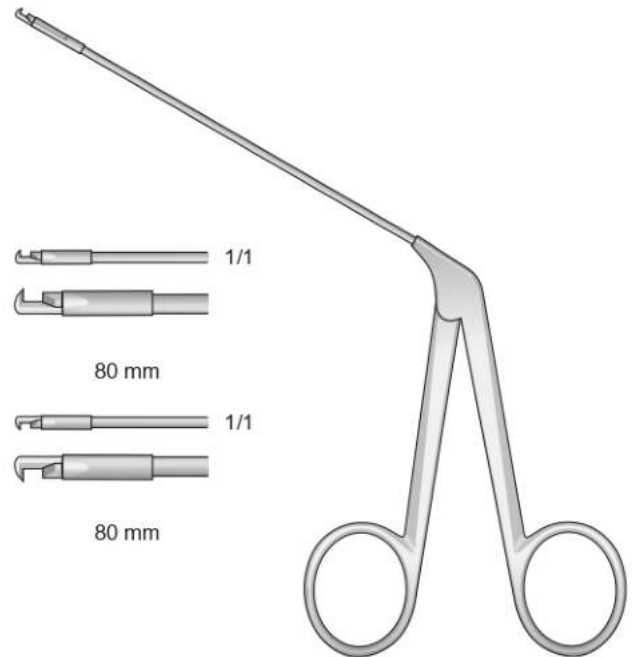
ST-8054
80 mm



BELLUCCI
ST-8055
80 mm



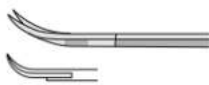
WULLSTEIN
ST-8056
80 mm



DIETER
ST-8057
80 mm



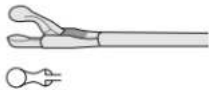
Mikro-Schere



FAHLBUSCH
ST-8058-1
165 mm

FAHLBUSCH
ST-8058-2
230 mm

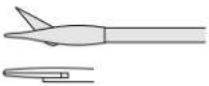
Scharfe Zange



NICOLA
ST-8058-3
165 mm

NICOLA
ST-8058-4
230 mm

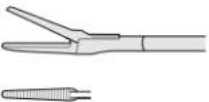
Mikro-Schere



NICOLA
ST-8058-5
165 mm

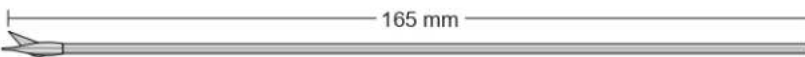
NICOLA
ST-8058-6
230 mm

Faßzange

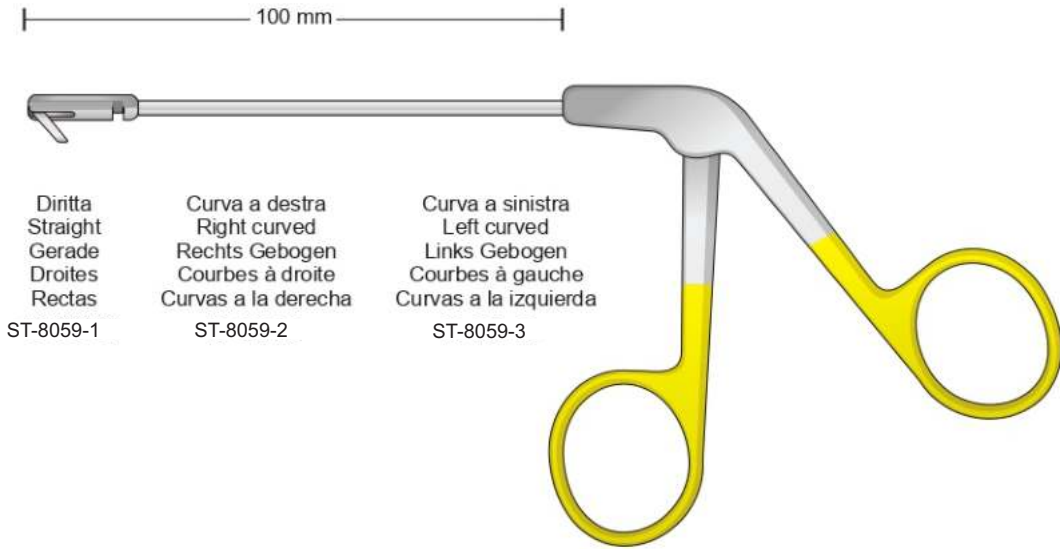


YASARGIL-NICOLA
ST-8058-7
165 mm

YASARGIL-NICOLA
ST-8058-8
230 mm



NICOLA
ST-8058
165 mm

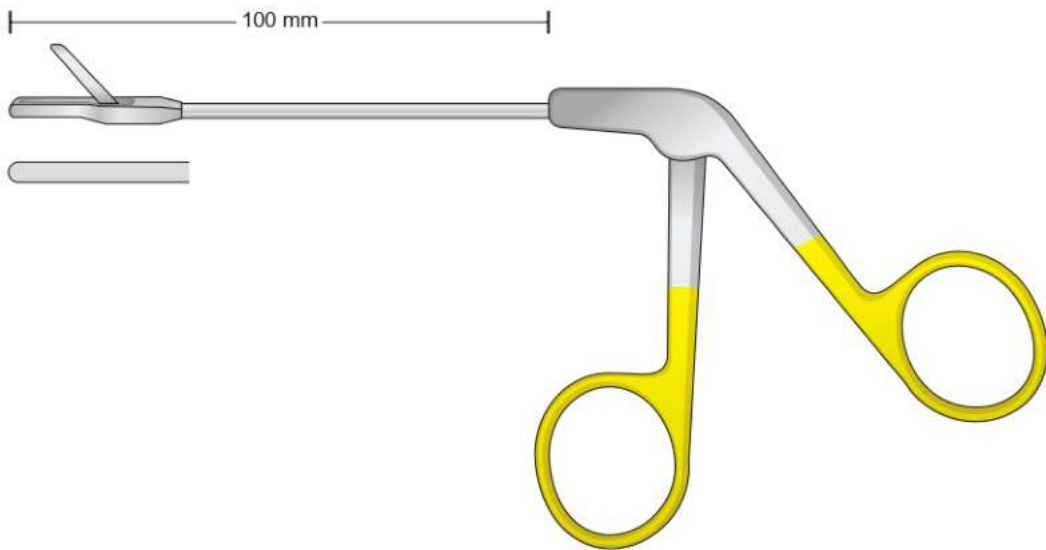


Dritta
Straight
Gerade
Droites
Rectas
ST-8059-1

Curva a destra
Right curved
Rechts Gebogen
Courbes à droite
Curvas a la derecha
ST-8059-2

Curva a sinistra
Left curved
Links Gebogen
Courbes à gauche
Curvas a la izquierda
ST-8059-3

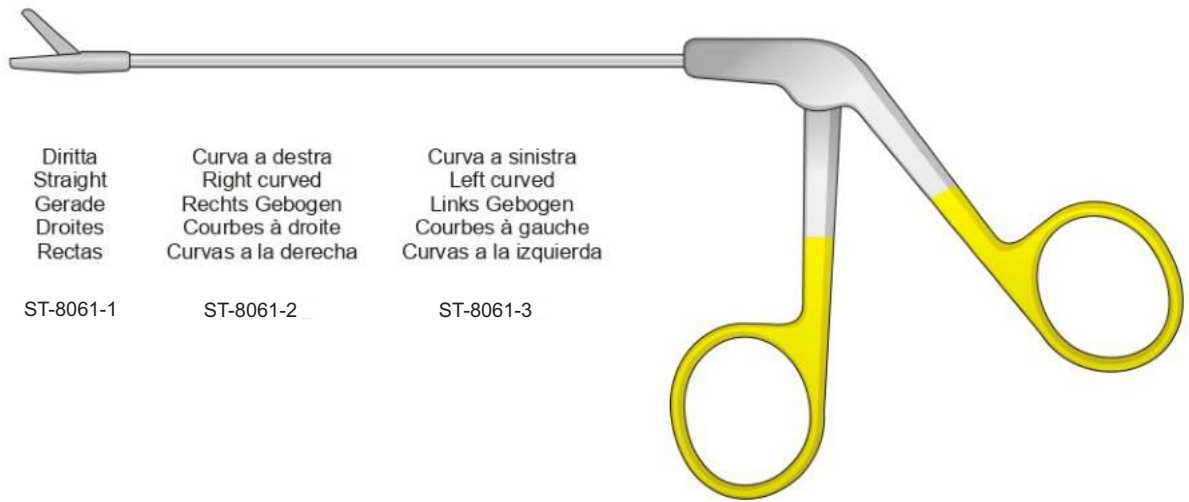
STAMBERGER
ST-8059



STRUYCKEN
ST-8060



130 mm



Diritta
Straight
Gerade
Droites
Rectas

ST-8061-1

Curva a destra
Right curved
Rechts Gebogen
Courbes à droite
Curvas a la derecha

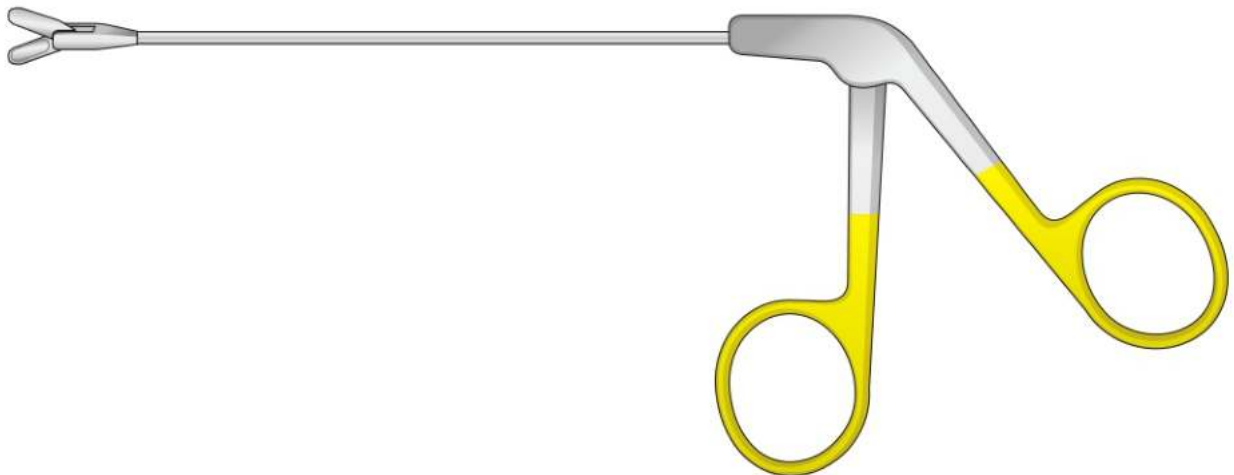
ST-8061-2

Curva a sinistra
Left curved
Links Gebogen
Courbes à gauche
Curvas a la izquierda

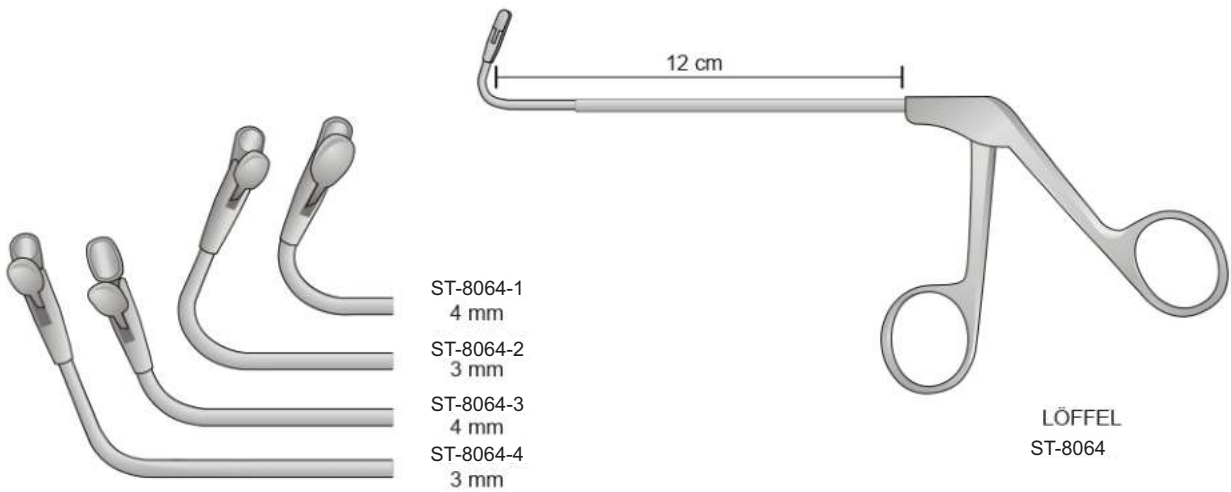
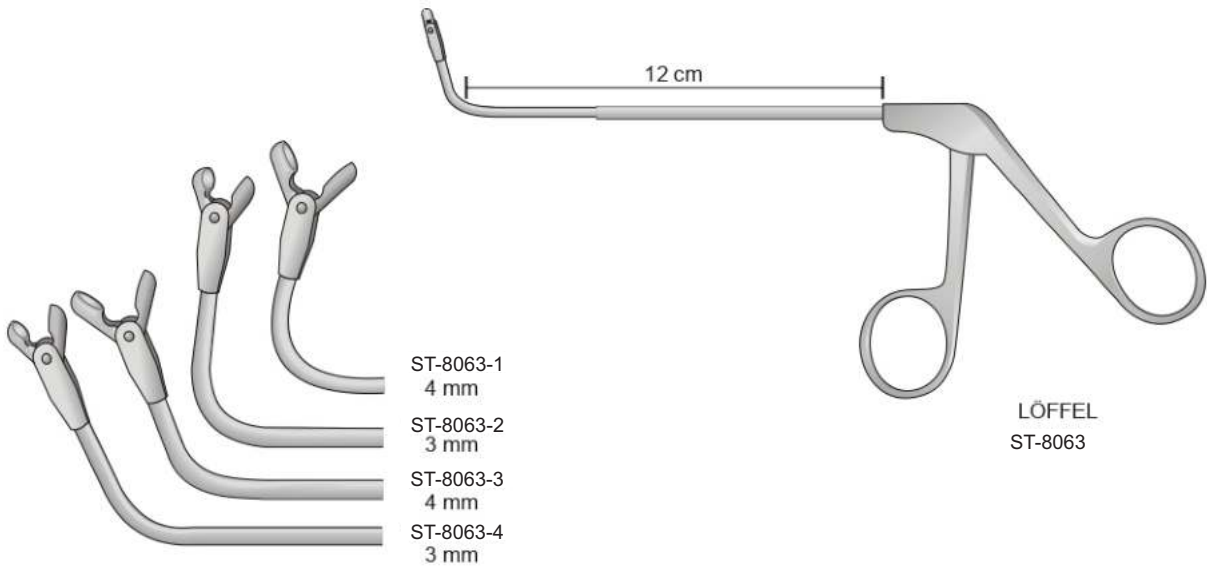
ST-8061-3

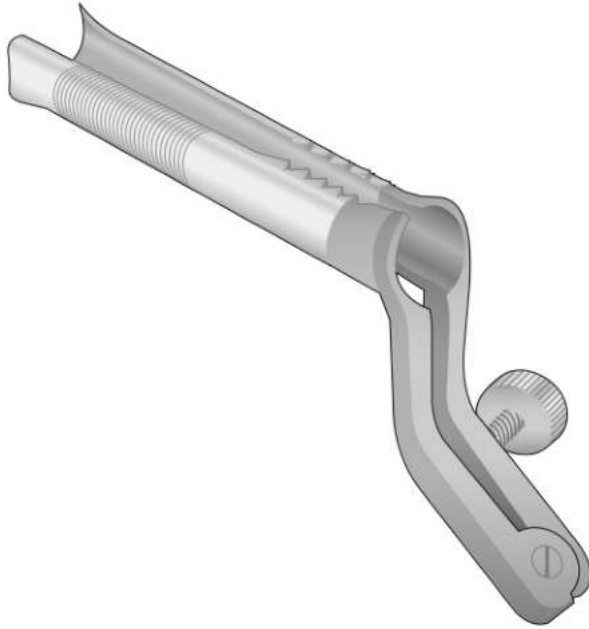
ST-8061

140 mm



ST-8062

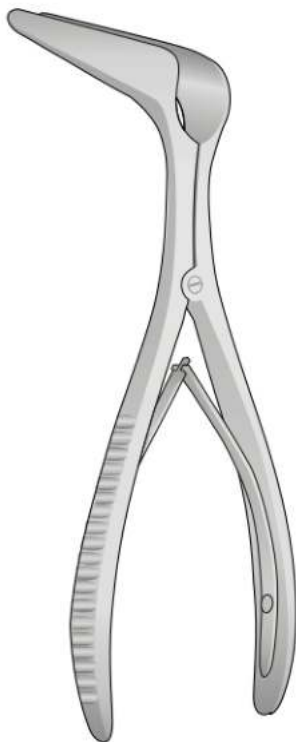




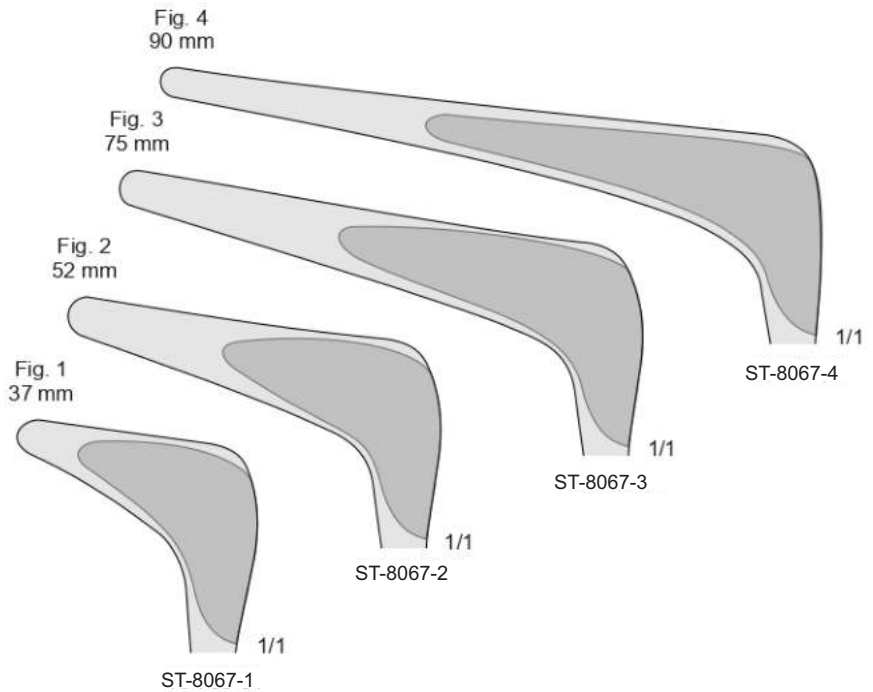
PAPAVERO-CASPAR
ST-8065-1 80 x 11 mm
ST-8065-2 90 x 13 mm
ST-8065-3 100 x 15 mm



PAPAVERO-HARTMANN
ST-8066
140 mm

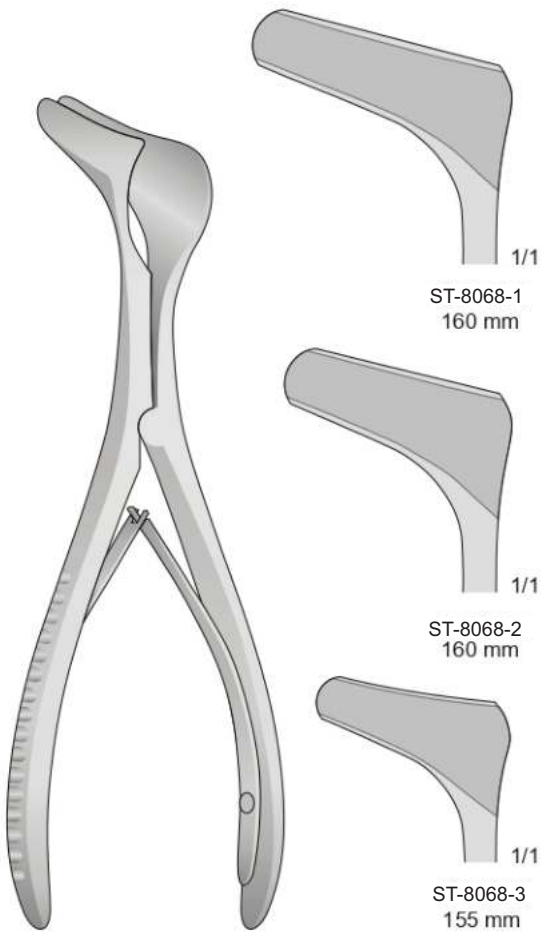


COTTLE
ST-8067
150 mm

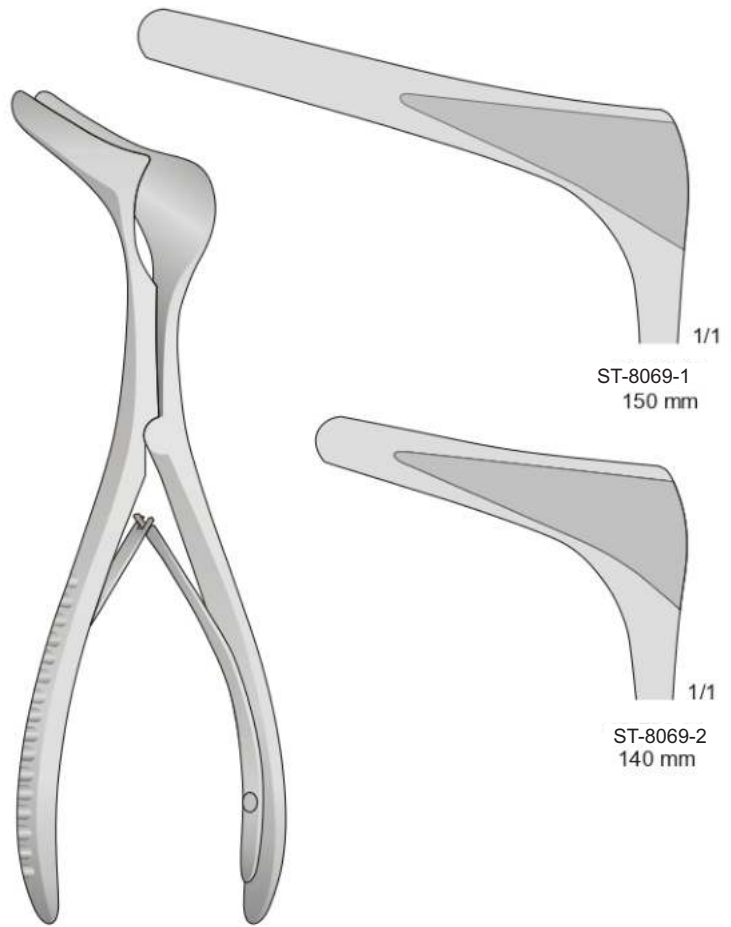




Speculum nasali
Nasal specula
Nasen Spekula
Spéculums nasaux
Espéculos nasales

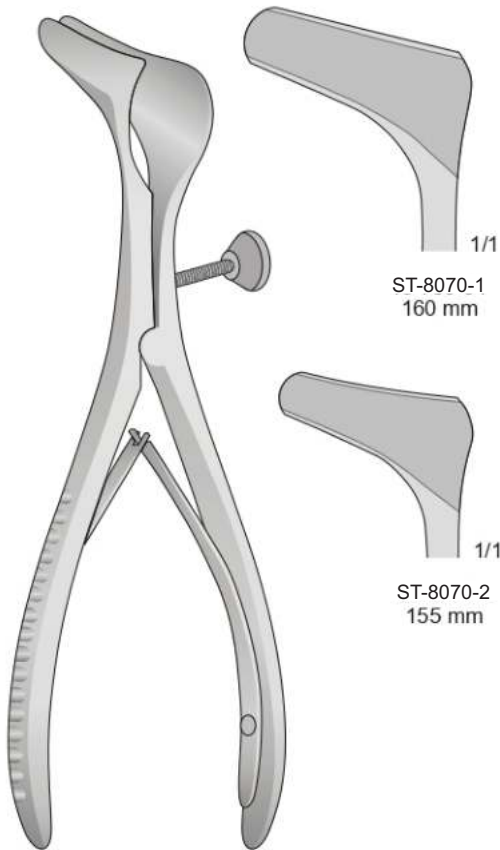


HARTMANN
ST-8068

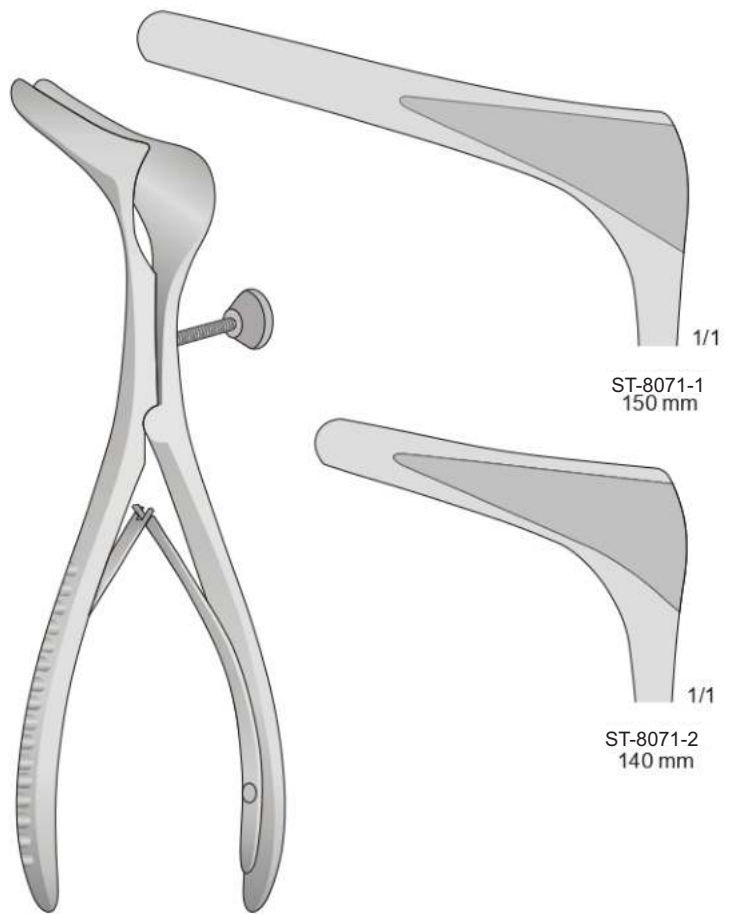


KILLIAN
ST-8069

Speculum nasali
Nasal specula
Nasen Spekula
Spéculums nasaux
Espéculos nasales



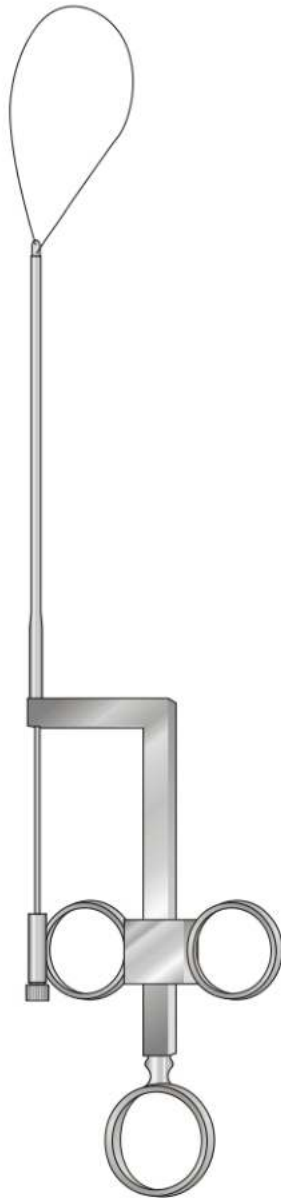
HARTMANN
ST-8070



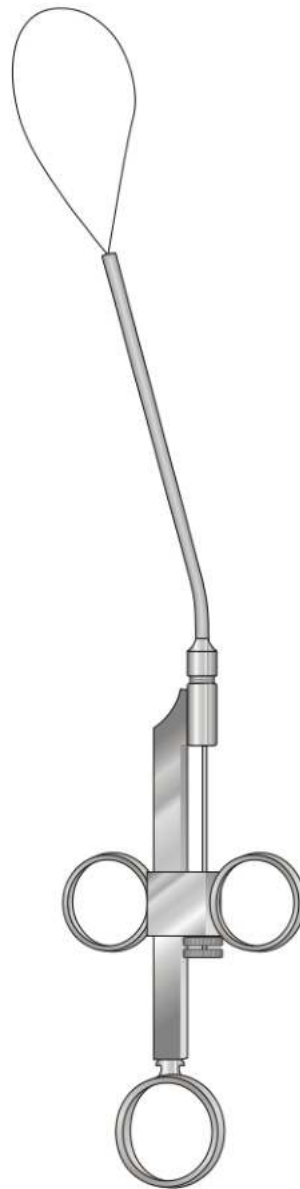
KILLIAN
ST-8071



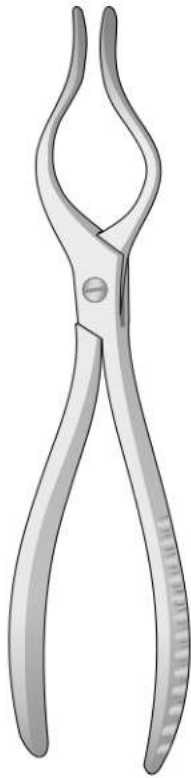
Pinza serranodi
Ear polypus snares
Polypenschnürer
Serre noeuds
Polipötomos



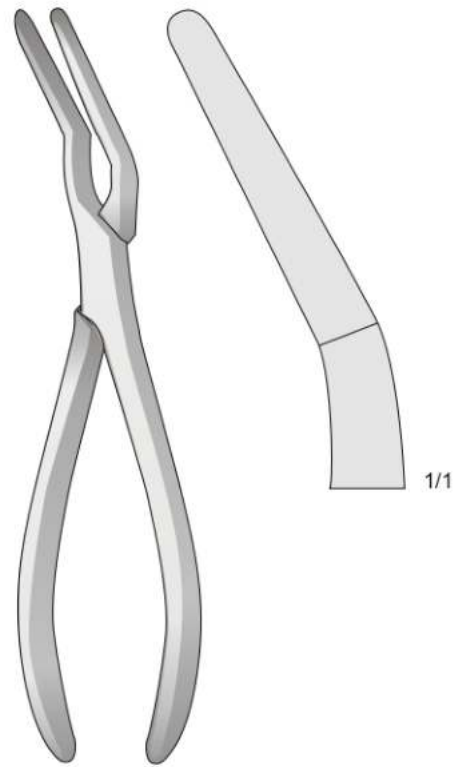
WILDE
ST-8072
240 mm



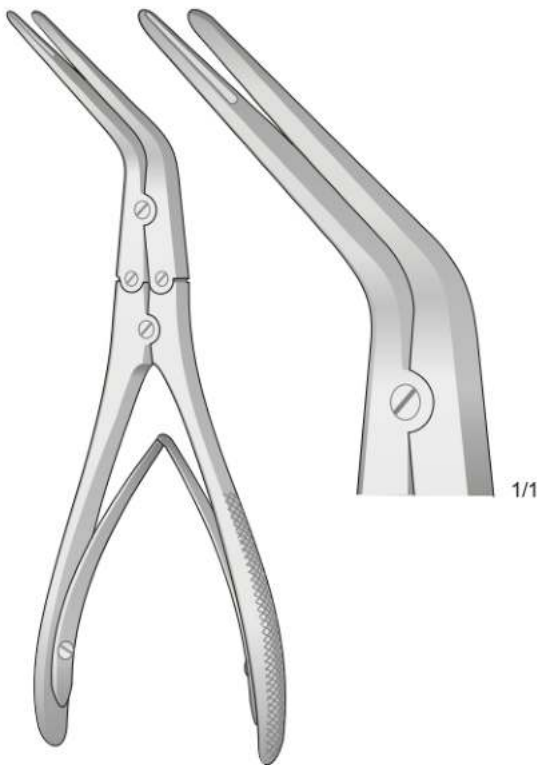
KRAUSE
ST-8073
260 mm



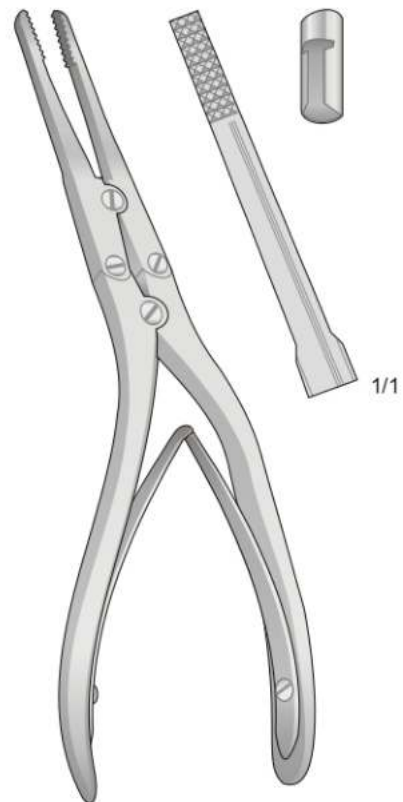
COTTLE-WALSHAM
ST-8074
230 mm



ASH
ST-8075
230 mm



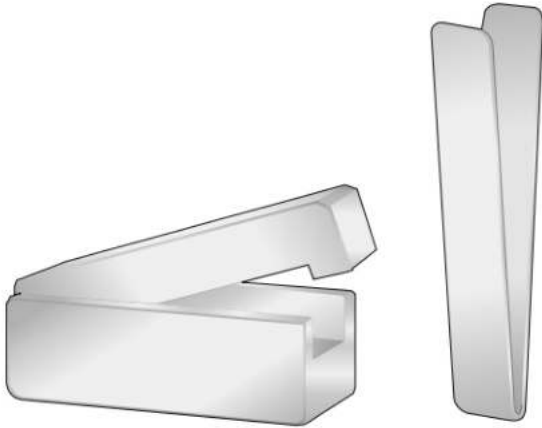
KRESSNER
ST-8076
200 mm



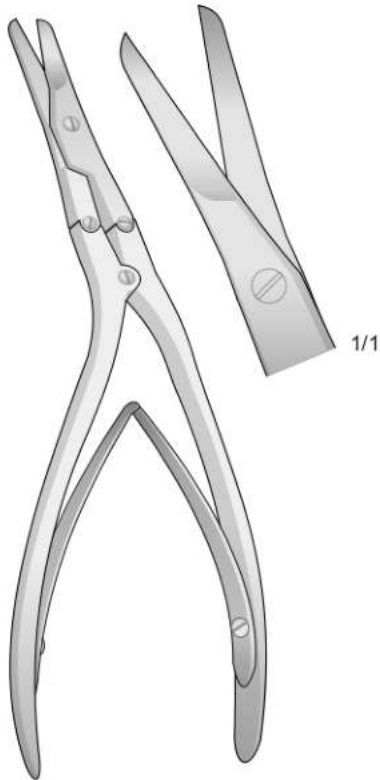
RUBIN
ST-8077
210 mm



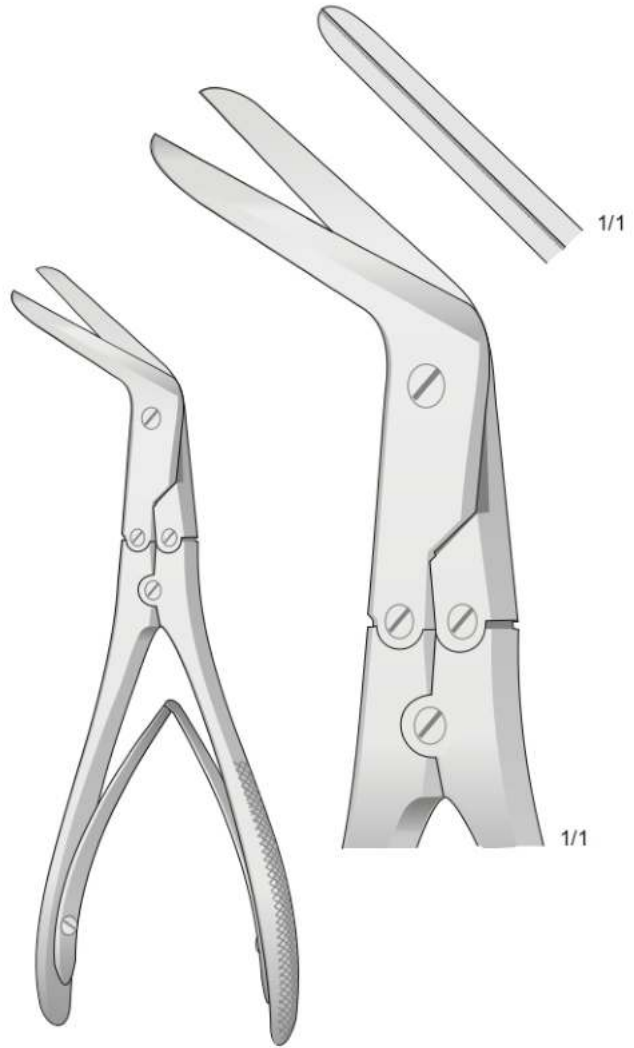
Strumento per rotture e asportazione frammenti ossei e cartilagine
 Bone crusher
 Knochen-Knorpelquetsche
 Instrument à écraser le cartilage
 Instrumento para magullar carilagos



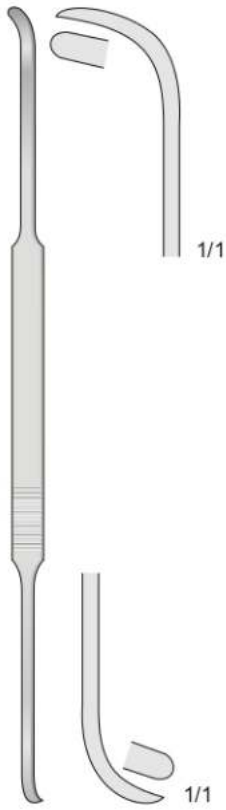
COTTLE
ST-8078



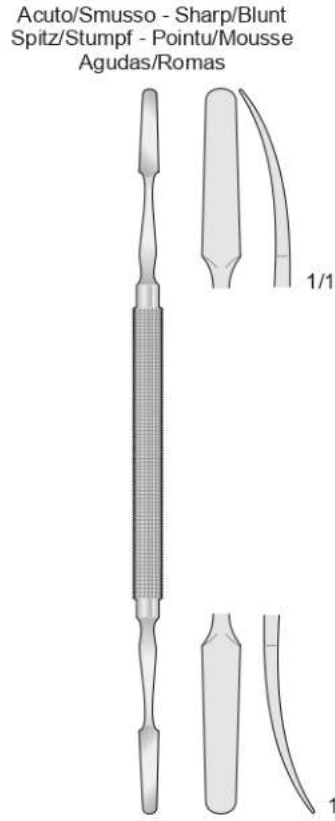
CAPLAN
ST-8079
200 mm



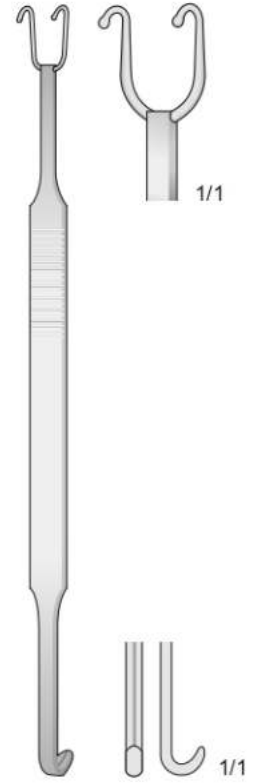
KILLIAN
ST-8080
210 mm



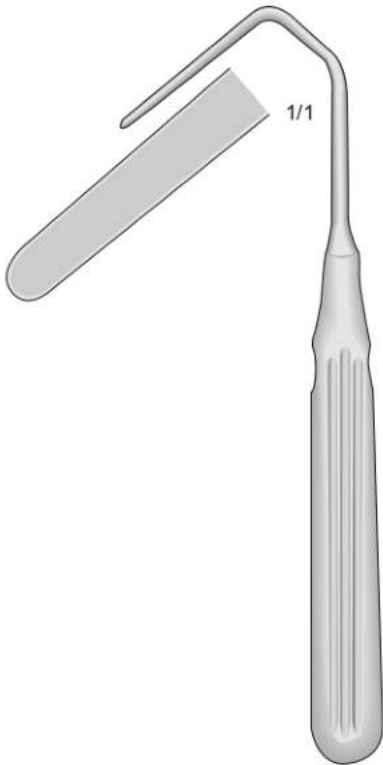
COTTLE
ST-8081
230 mm



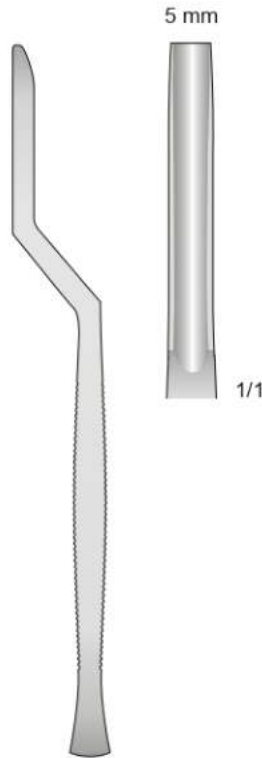
KILIAN
ST-8082
180 mm



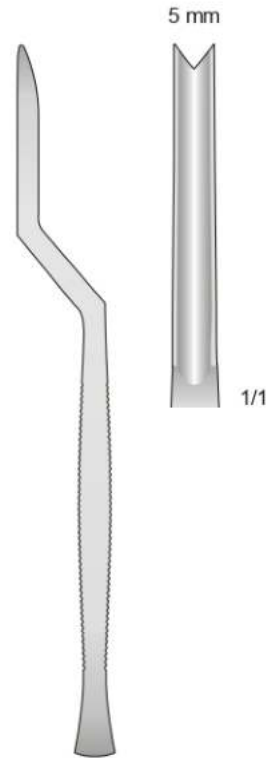
COTTLE-NEIVERT
ST-8083
200 mm



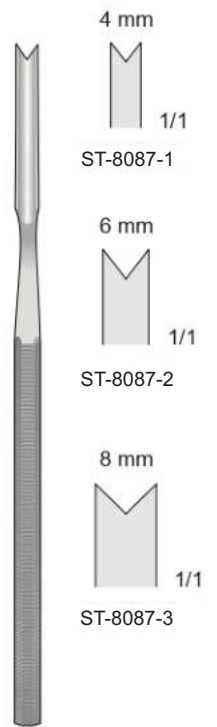
AUFRICHT
ST-8084
175 mm



KILIAN
ST-8085
160 mm

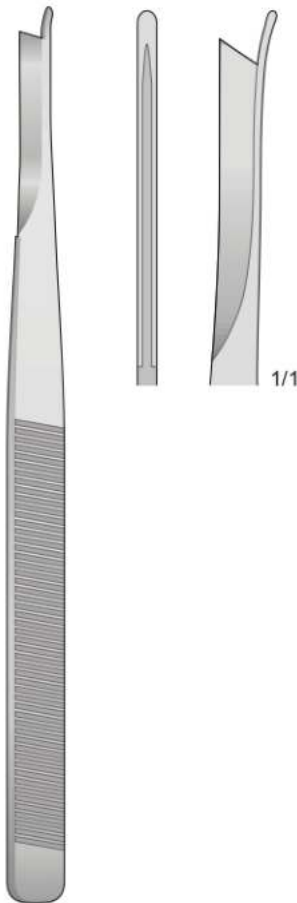


KILIAN-KLAUS
ST-8086
160 mm



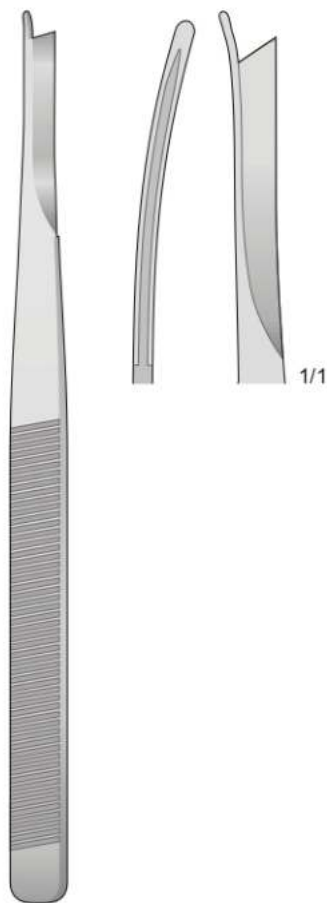
BALLENGER
ST-8087
150 mm

Dritta
Straight
Gerade
Droites
Rectas



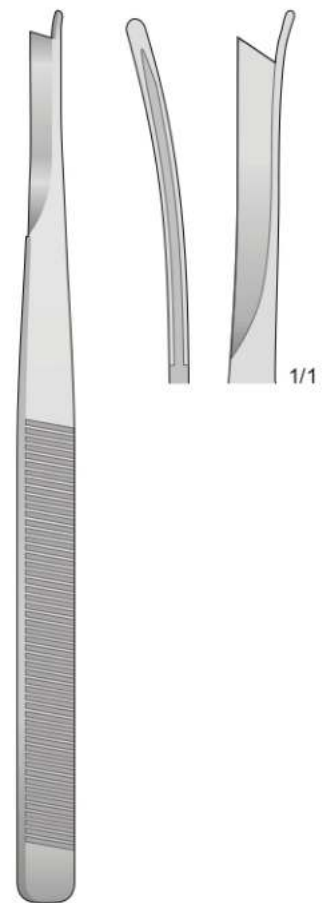
SILVER
ST-8088-1
180 mm

Curva, sinistra
Curved, left
Gebogen, links
Courbes à gauche
Curvas a la izquierda

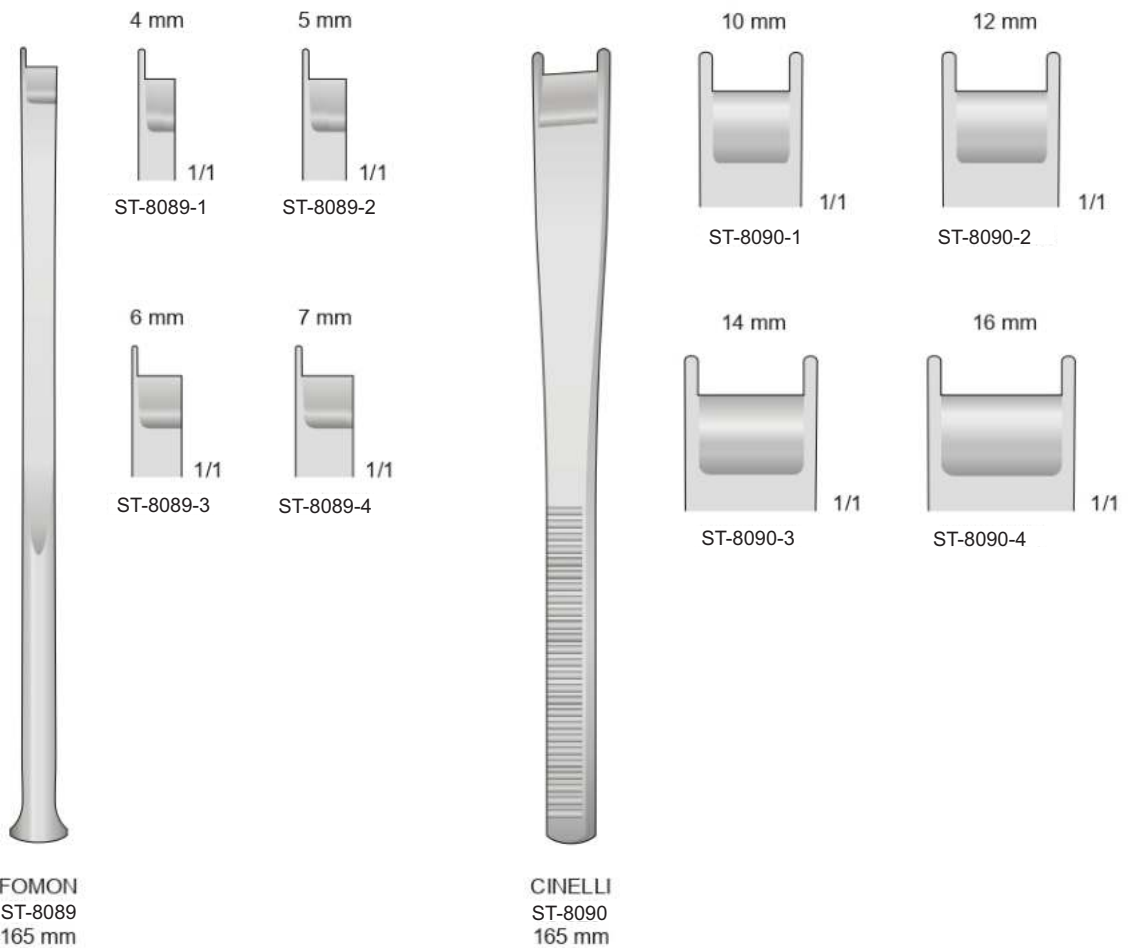


SILVER
ST-8088-2
180 mm

Curva, destra
Curved, right
Gebogen, rechts
Courbes à droite
Curvas a la derecha

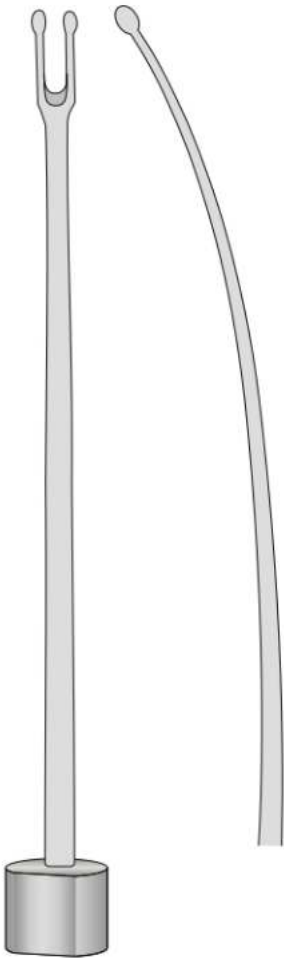


SILVER
ST-8088-3
180 mm



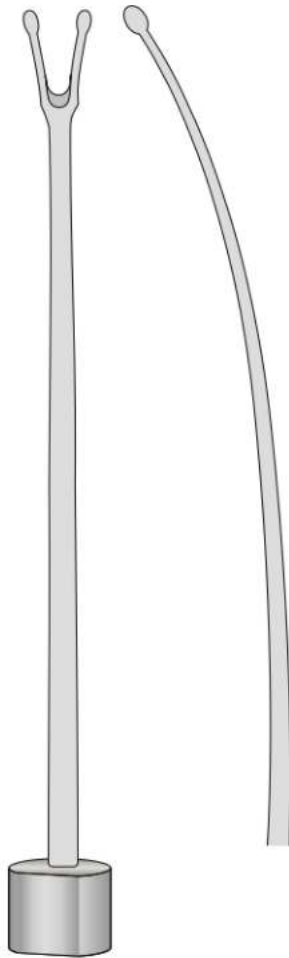
Nasal septum
Osteotomes, graduated

U form



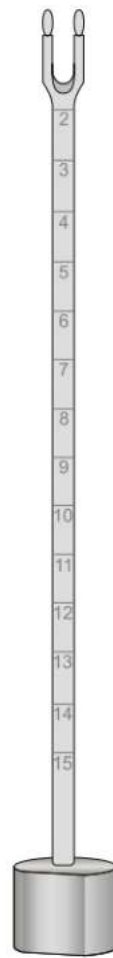
OBWEGESER
ST-8091-1
185 mm

V form



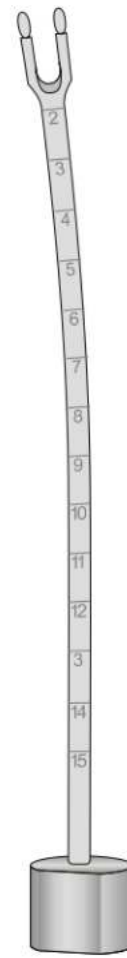
OBWEGESER
ST-8091-2
185mm

4 mm



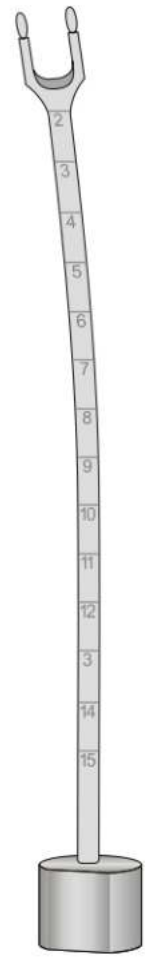
OBWEGESER
ST-8091-3
185 mm

6 mm

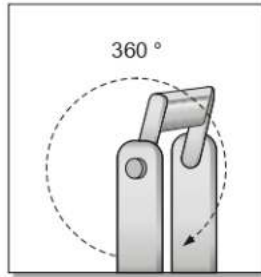


OBWEGESER
ST-8091-4
185 mm

8 mm



OBWEGESER
ST-8091-5
185 mm



BALLENGER
ST-8092
200 mm



ST-8092-1
3 mm



ST-8092-2
4 mm



ST-8092-3
5 mm



BALLENGER
ST-8093
200 mm



ST-8093-1
3 mm

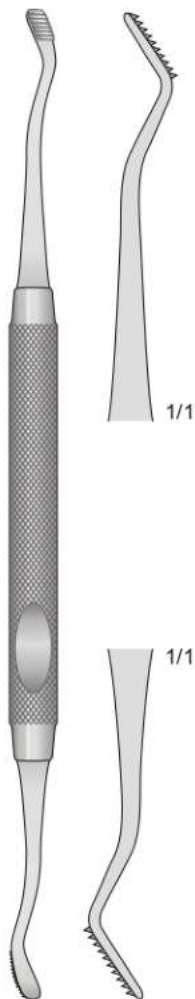


ST-8093-2
4 mm



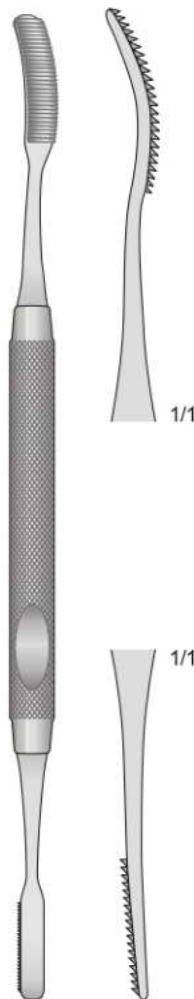
ST-8093-3
5 mm

Fig. 67



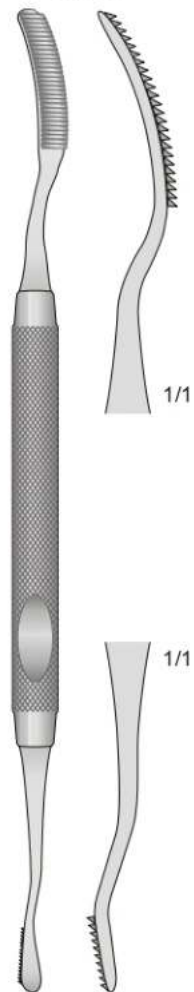
HOWARD
ST-8094
180 mm

Fig. 45

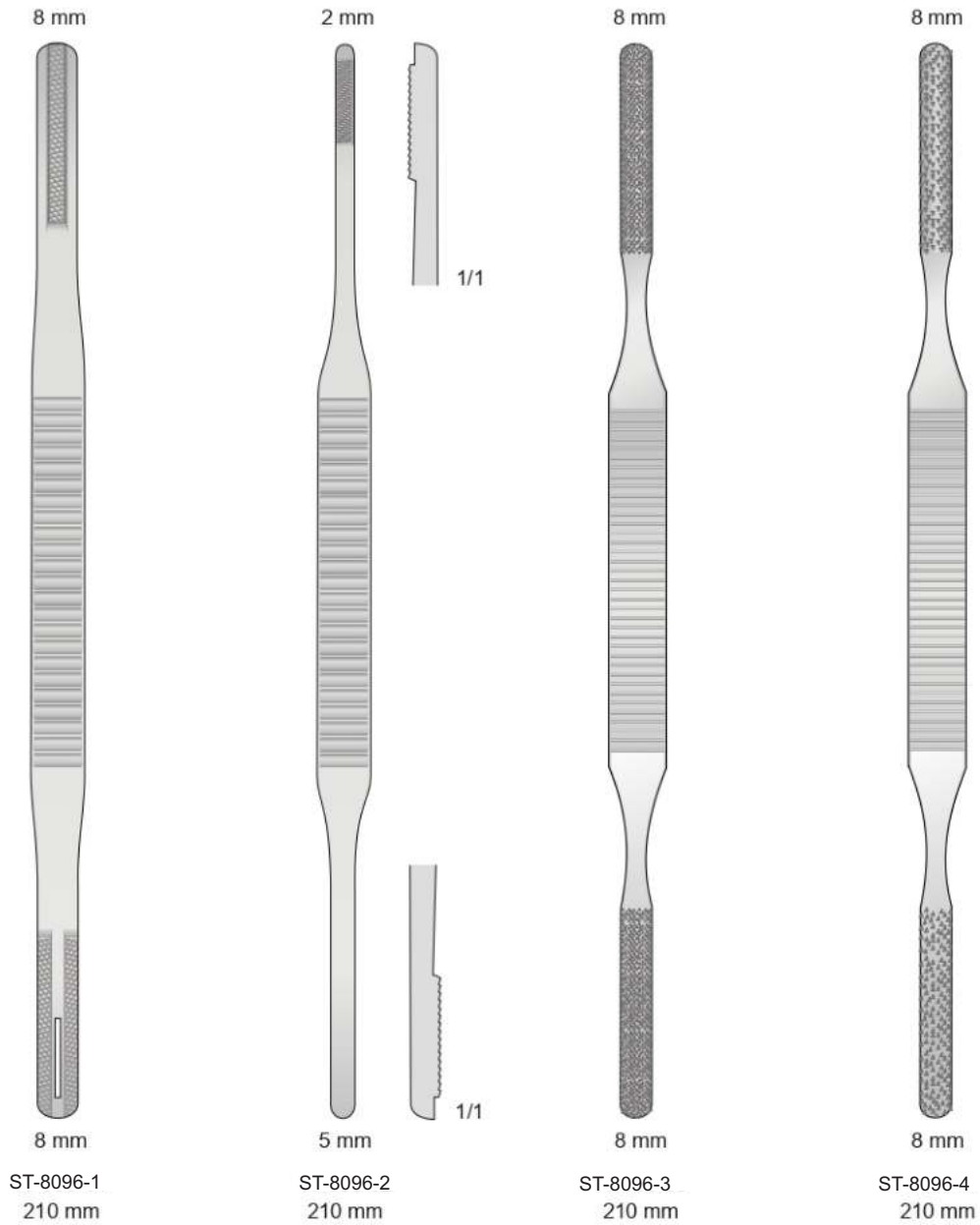


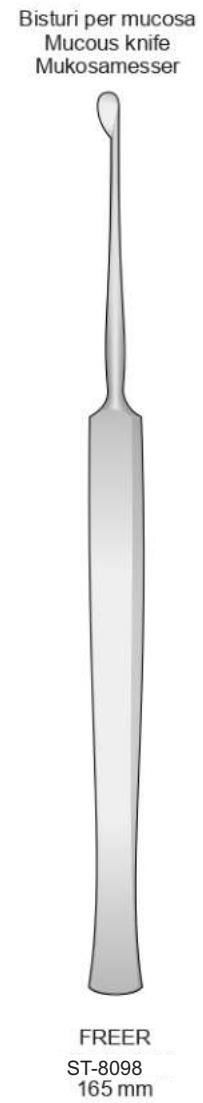
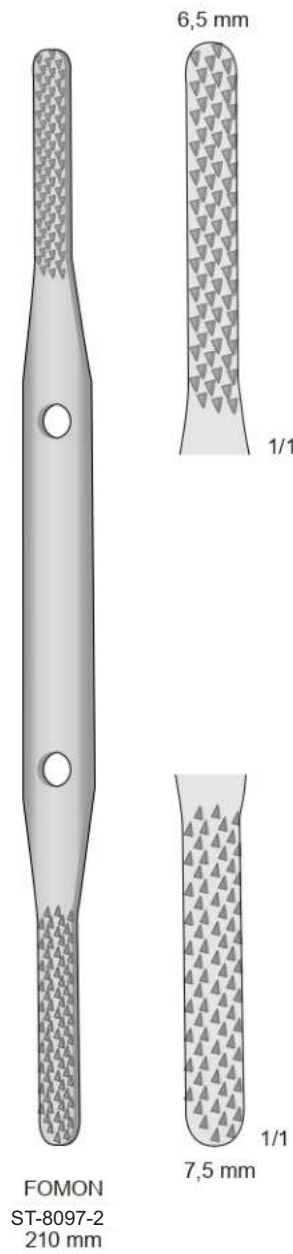
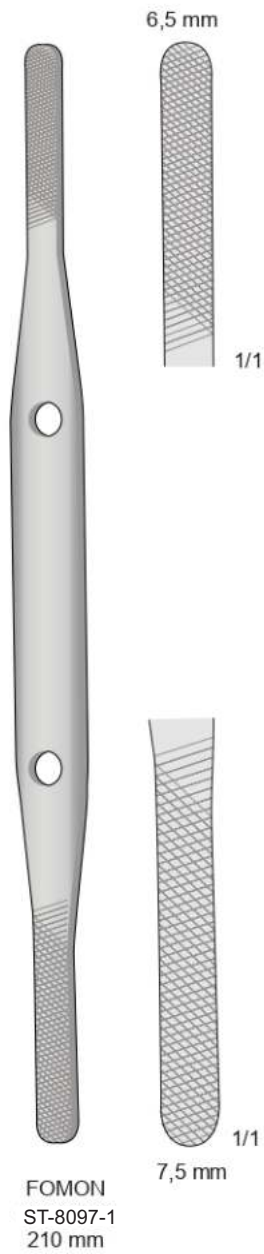
MILLER
ST-8095-1
185 mm

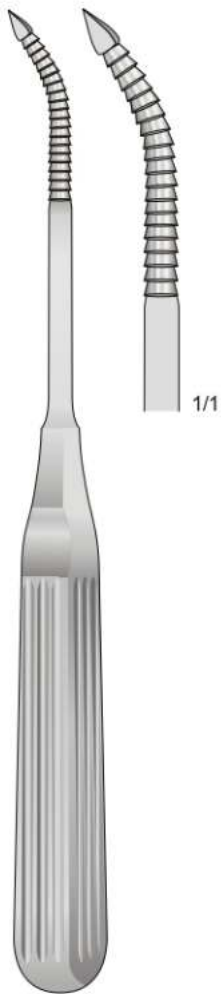
Fig. 52



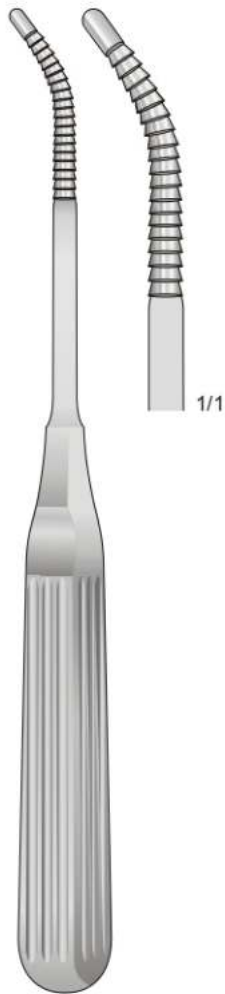
MILLER
ST-8095-2
180 mm







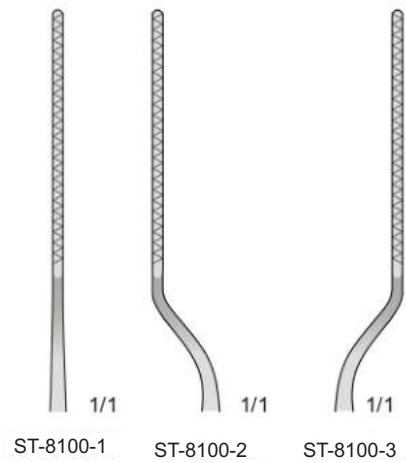
LEWIS
ST-8099-1
180 mm



LEWIS
ST-8099-2
180 mm



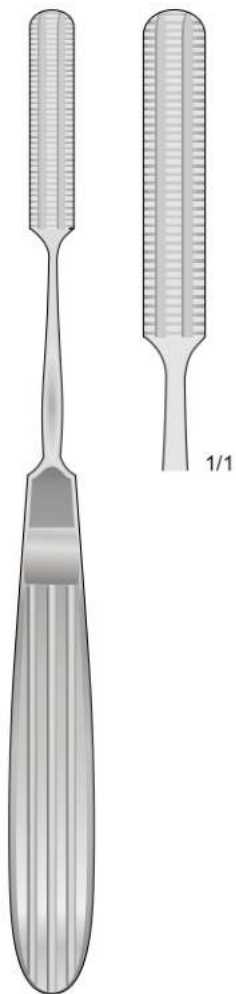
JOSEPH
ST-8100
190 mm



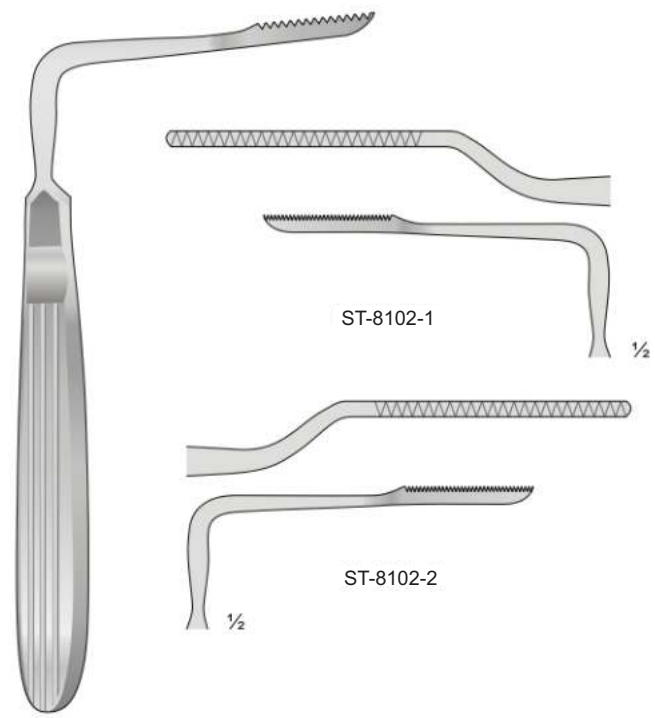
ST-8100-1

ST-8100-2

ST-8100-3



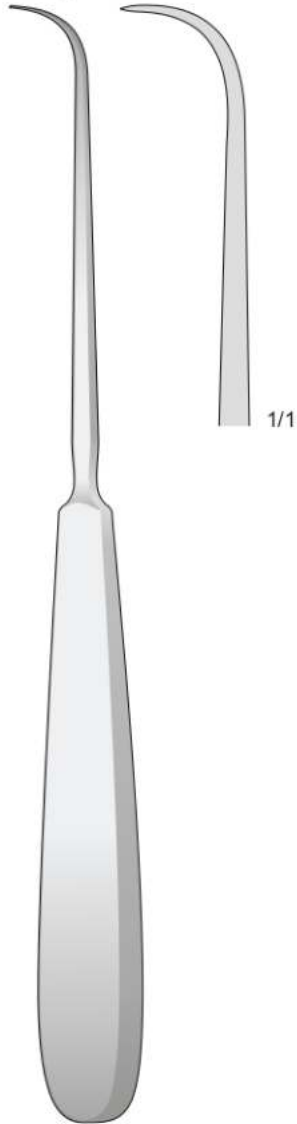
MALTZ
ST-8101
180 mm



JOSEPH
ST-8102
135 mm



Uncino per arco zigomato
Zigoma hook
Haken-Jochbogenahle



ST-8103
200 mm

Curette taglienti
Scharfe Küretten
Curettes Tranchantes



COAKLEY
ST-8104
170 mm

Fig. 1



ST-8104-1

Fig. 2



ST-8104-2

Fig. 3



ST-8104-3

Fig. 4



ST-8104-4

Fig. 5



ST-8104-5

Fig. 6



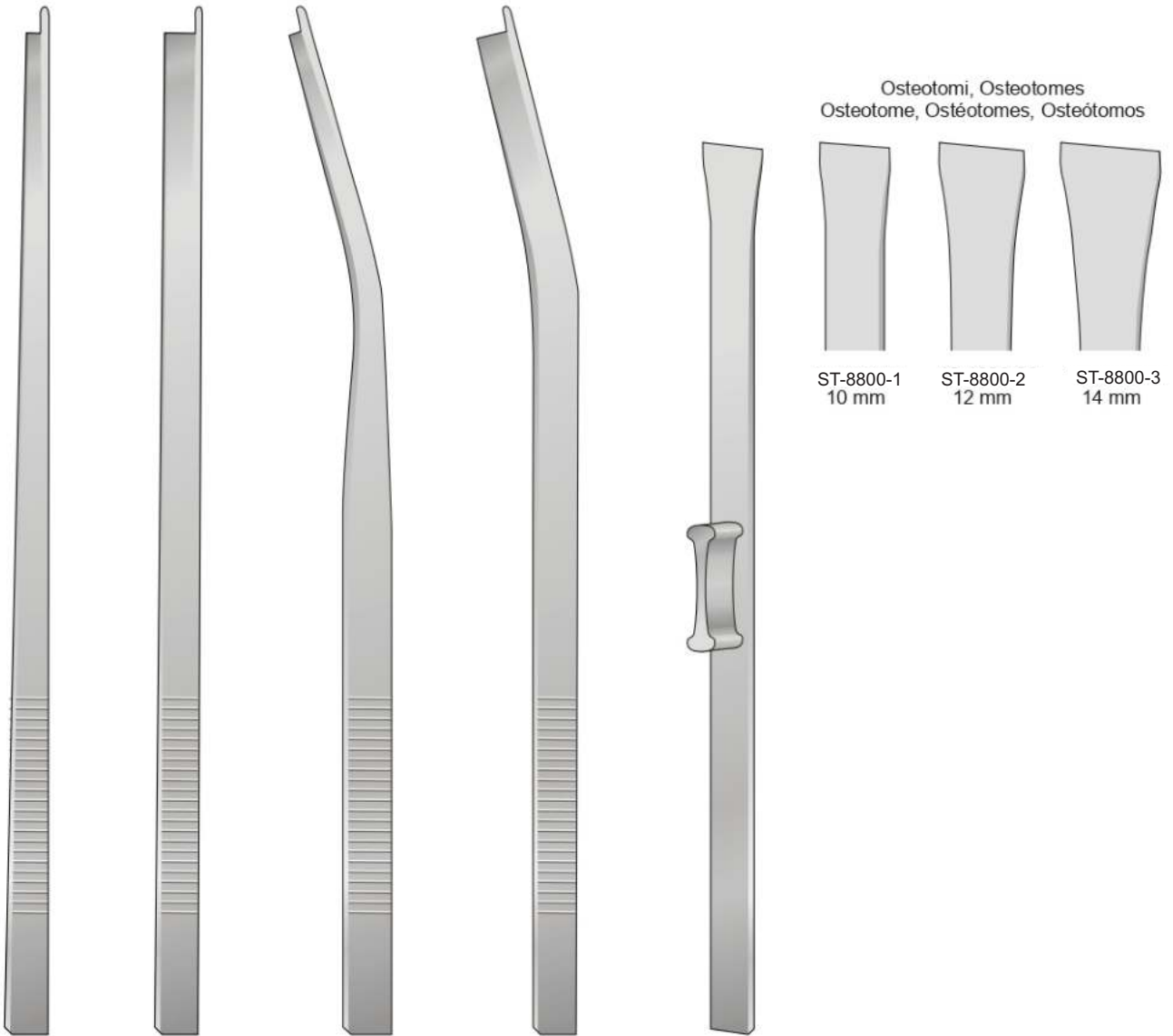
ST-8104-6

Adenotomi - Adenotomie - Adenoidectomy
Adénoïdes - Adenoides



BECKMANN
ST-8105
220 mm





Osteotomi, Osteotomes
Osteotome, Ostéotomes, Osteótomos

ST-8106-1
200 mm

ST-8106-2
200 mm

ST-8106-3
200 mm

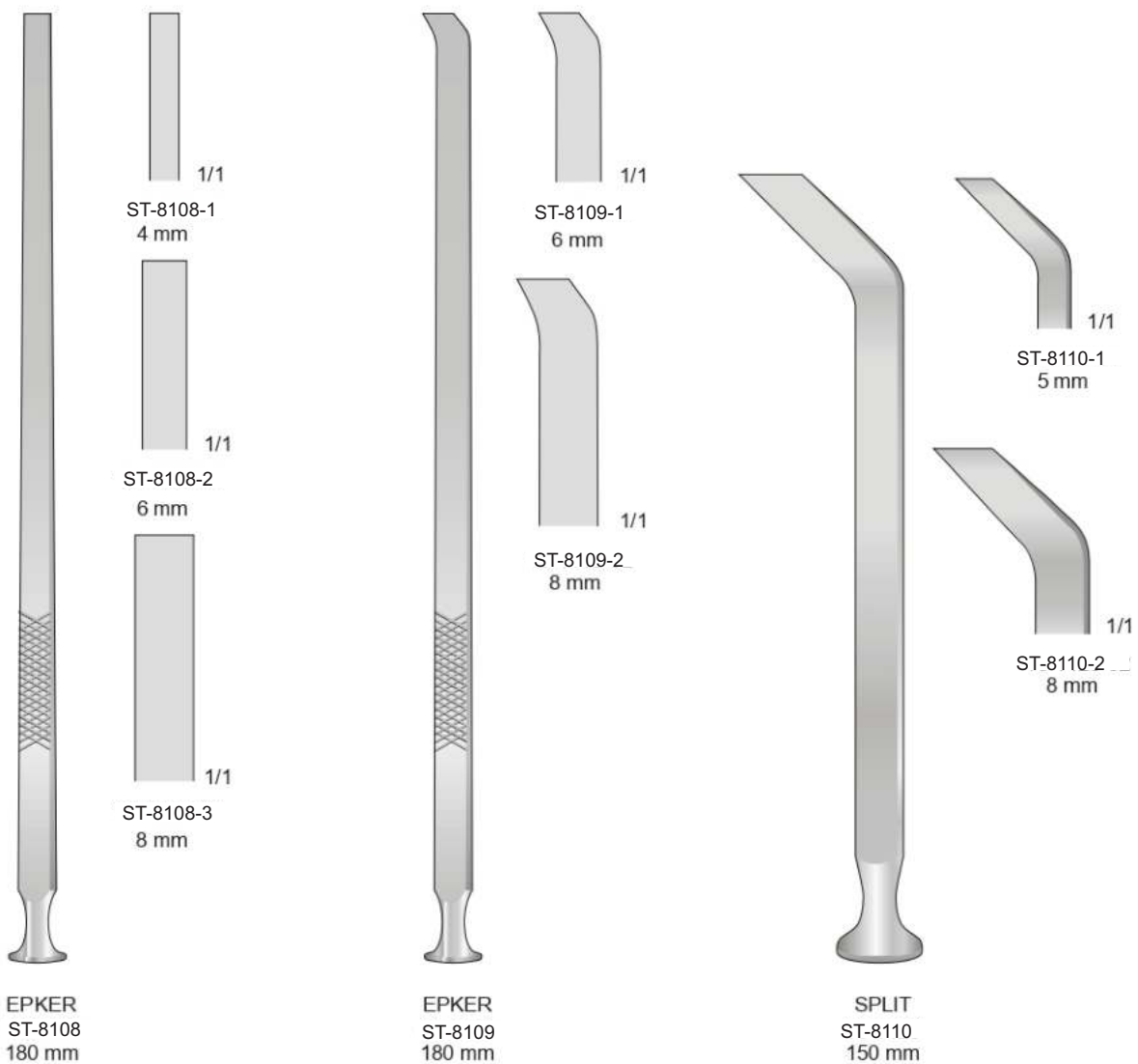
ST-8106-4
200 mm

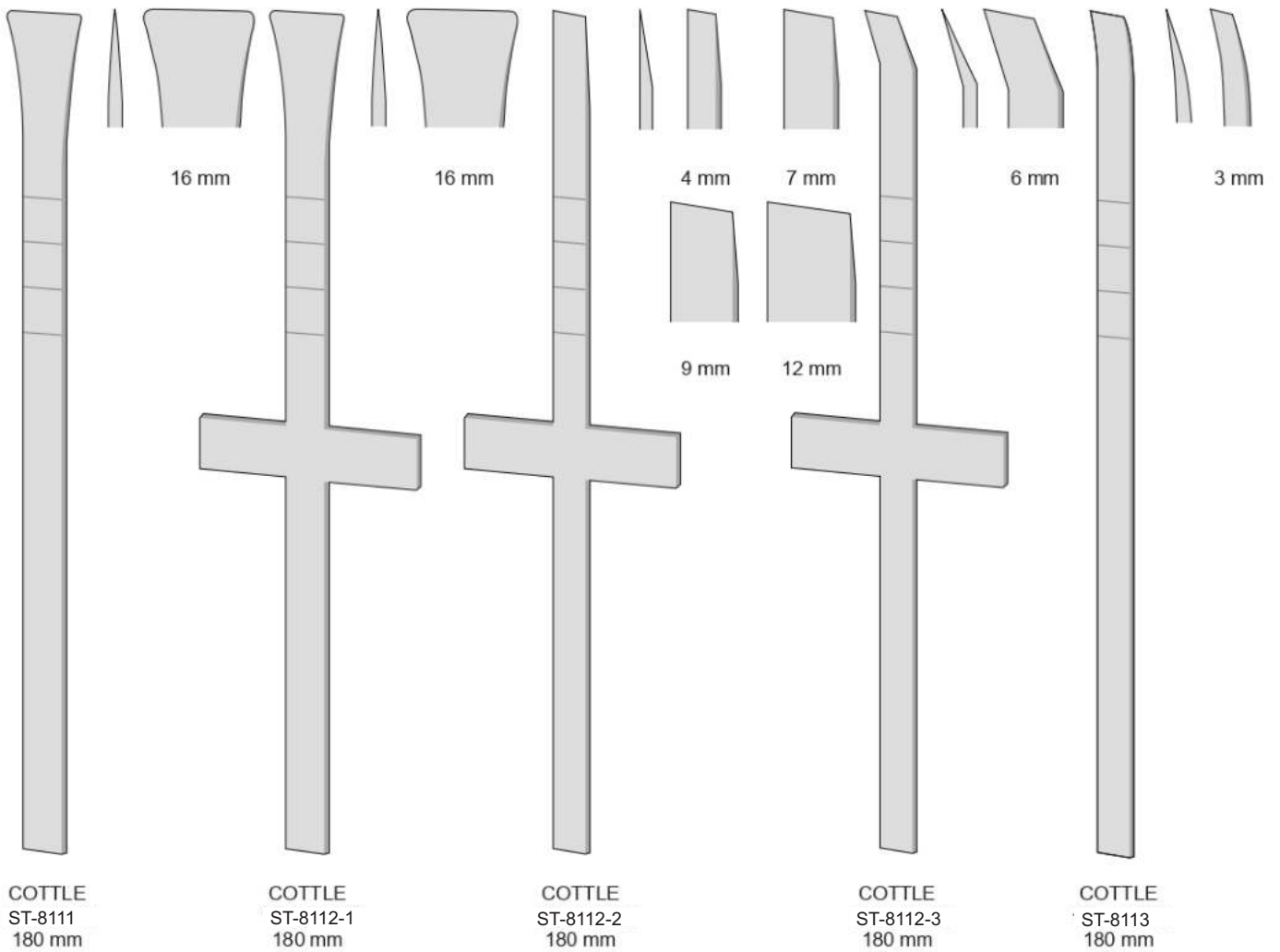
RUBIN
ST-8107
180 mm

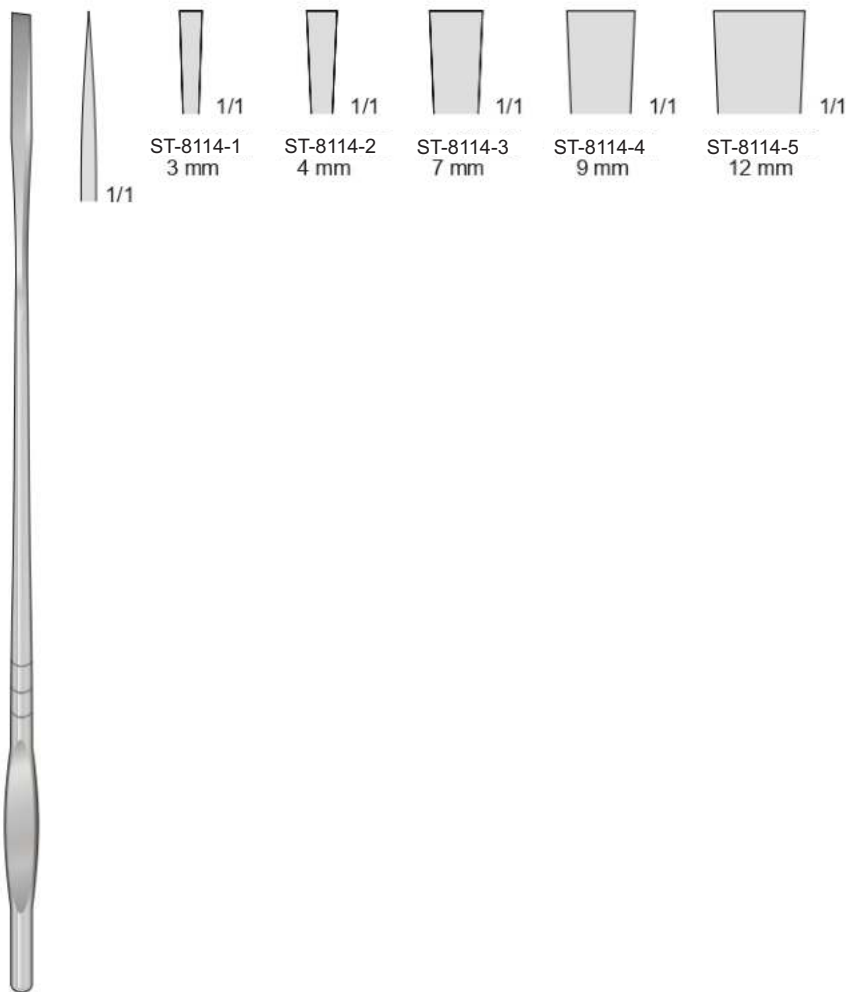
ST-8800-1
10 mm

ST-8800-2
12 mm

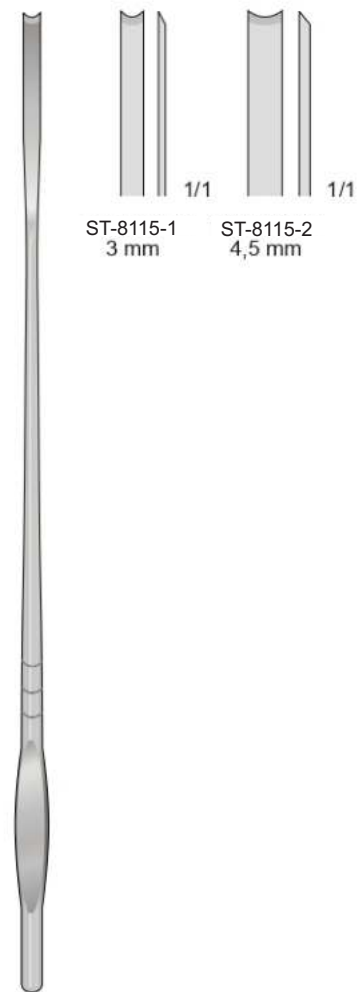
ST-8800-3
14 mm



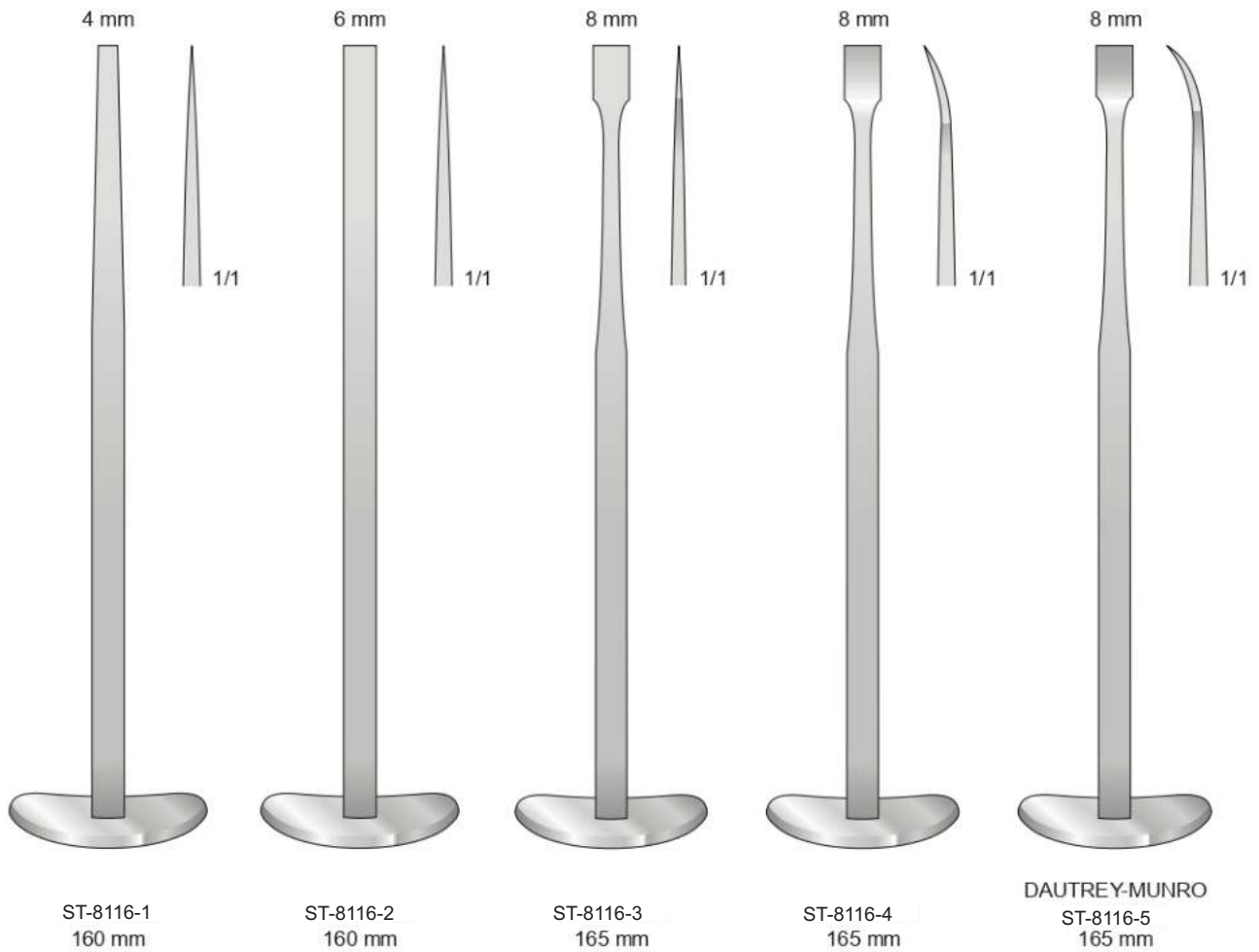




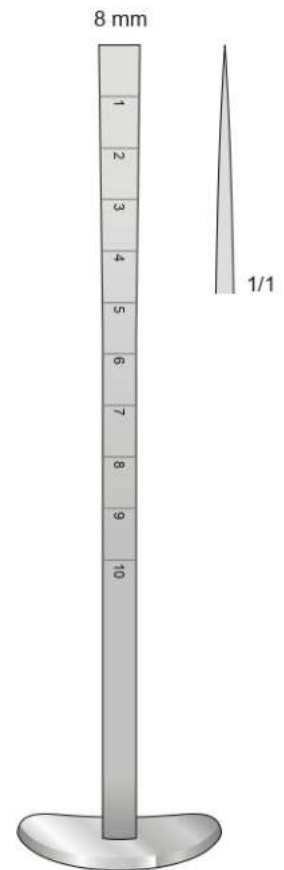
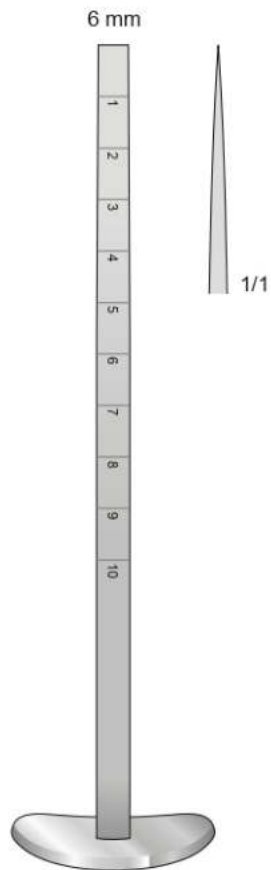
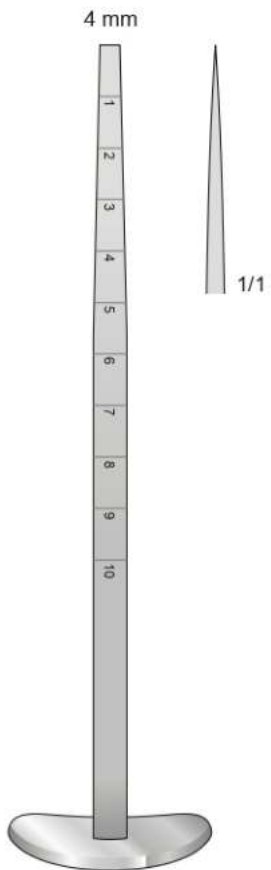
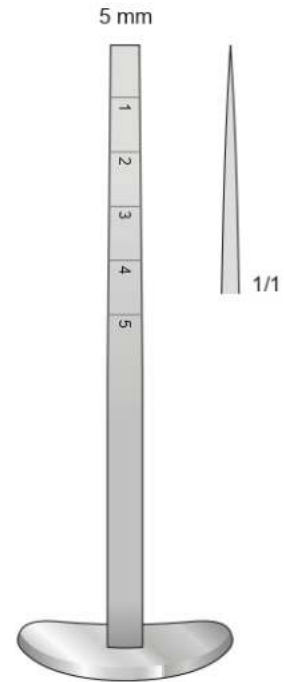
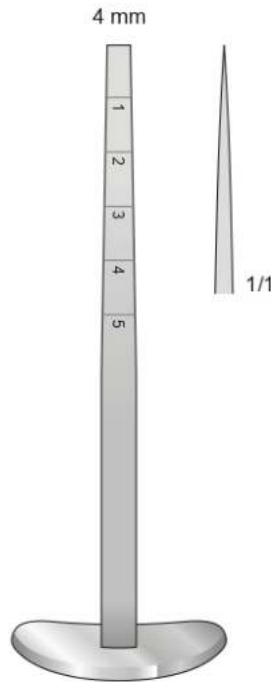
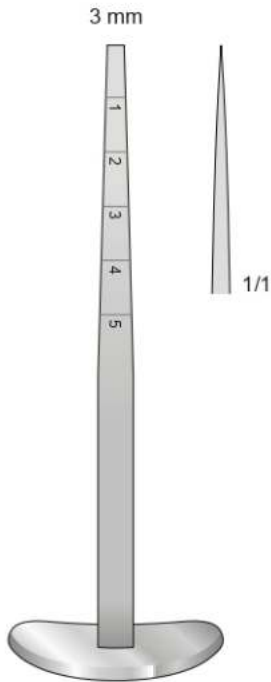
ST-8114
190 mm

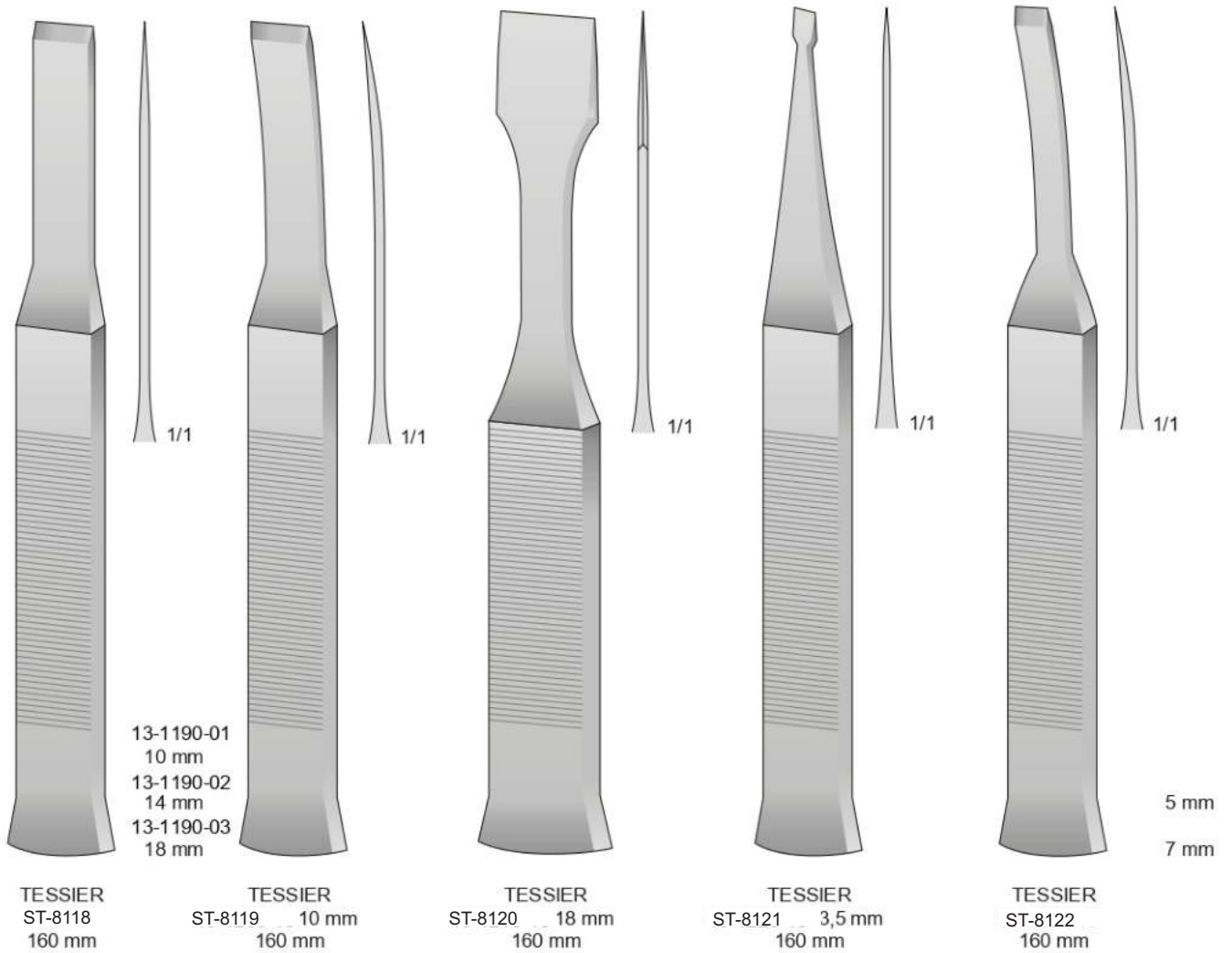


ST-8115
190 mm



Osteotomi diritti graduati







Osteotomi nasali
Nasal Osteotomes
Nasen Osteotome
Ostéotomes nasaux
Osteotomos nasales

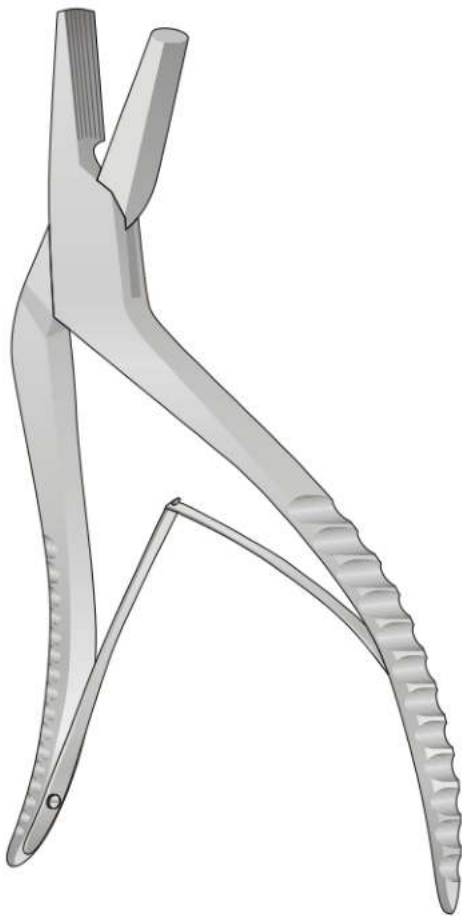
Manico in ferrozell
With Ferrozell Handle
Mit Ferrozell-Griff
Avec poignée en Ferrozell
Con mango de Ferrozell



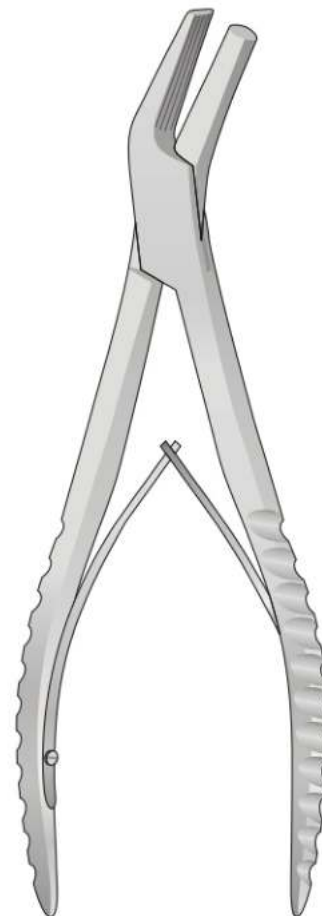
ST-8123-1
170 mm

ST-8123-2
190 mm

ST-8124-1 destro - R
ST-8124-2 sinistro - L
205 mm



TESSIER
ST-8125
195 mm



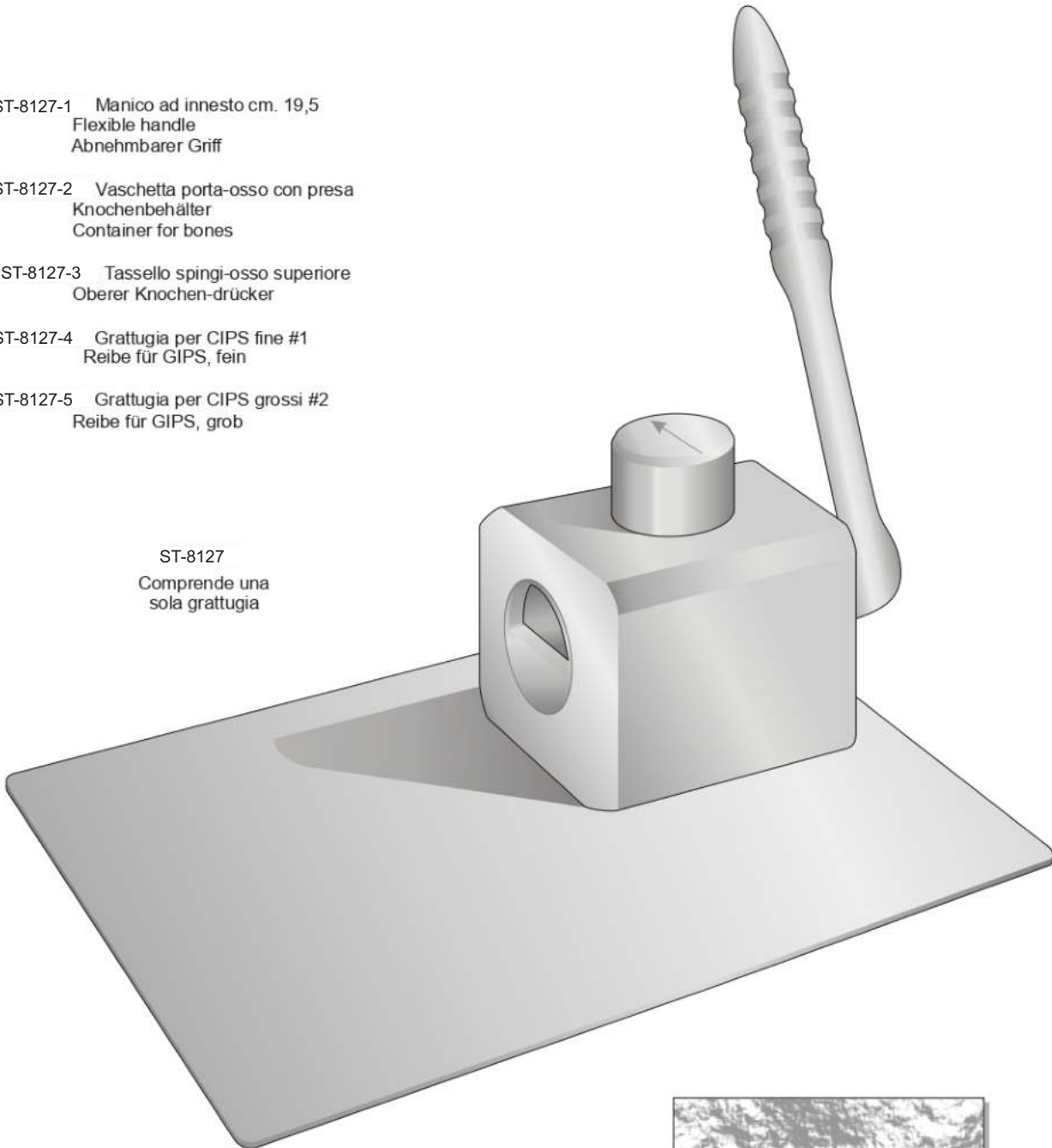
TESSIER
ST-8126
220 mm



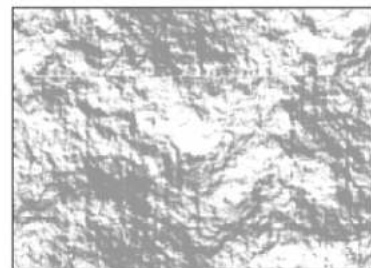
Bone cutters
Macina osso

- ST-8127-1 Manico ad innesto cm. 19,5
Flexible handle
Abnehmbarer Griff
- ST-8127-2 Vaschetta porta-osso con presa
Knochenbehälter
Container for bones
- ST-8127-3 Tassello spingi-osso superiore
Oberer Knochen-drücker
- ST-8127-4 Grattugia per CIPS fine #1
Reibe für GIPS, fein
- ST-8127-5 Grattugia per CIPS grossi #2
Reibe für GIPS, grob

ST-8127
Comprende una
sola grattugia



GABON
ST-8128
235 x 160 x 100 mm
Kg 4,5

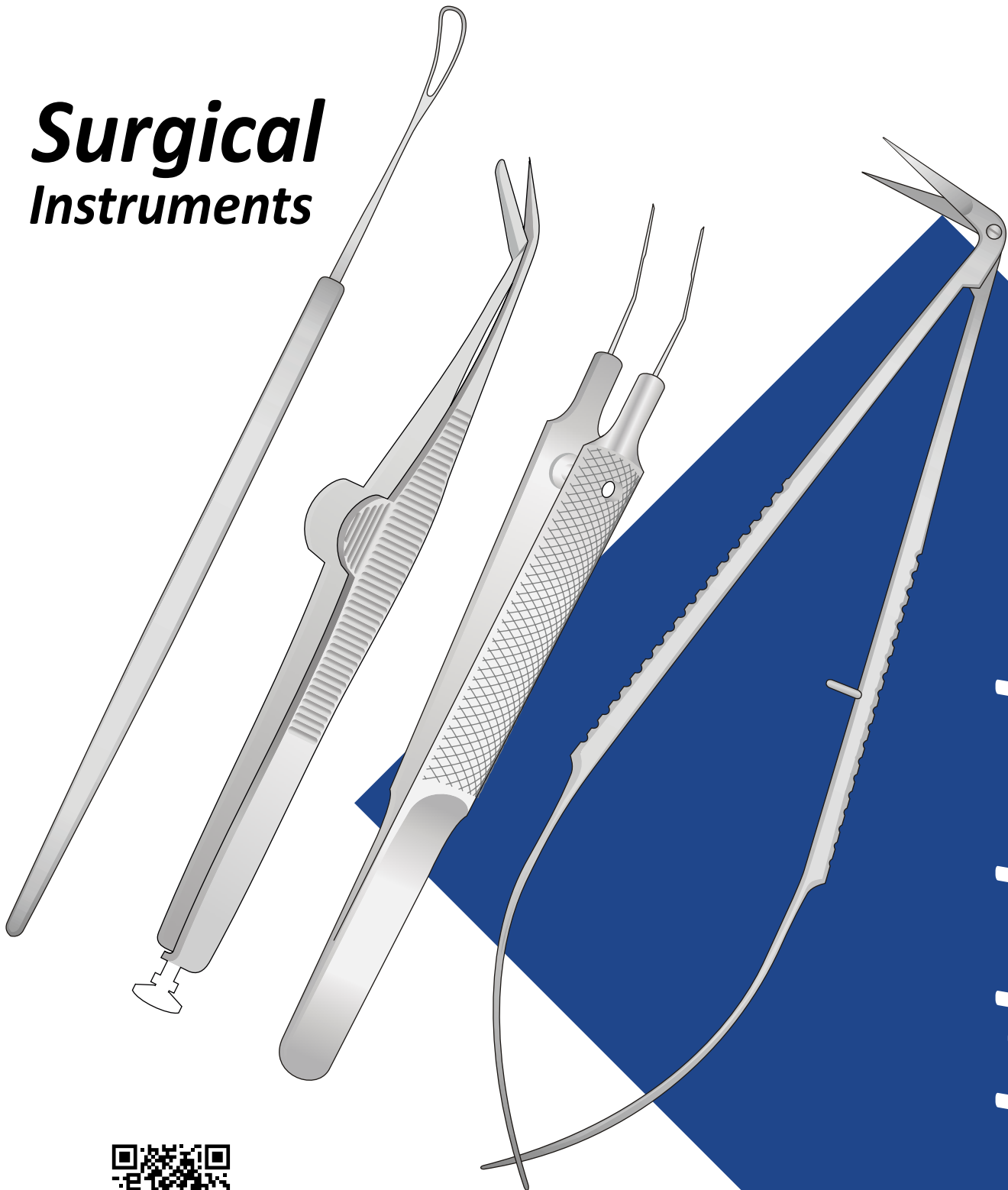


Cips macinato



SAFE TOOL
MANUFACTURER & EXPORTER

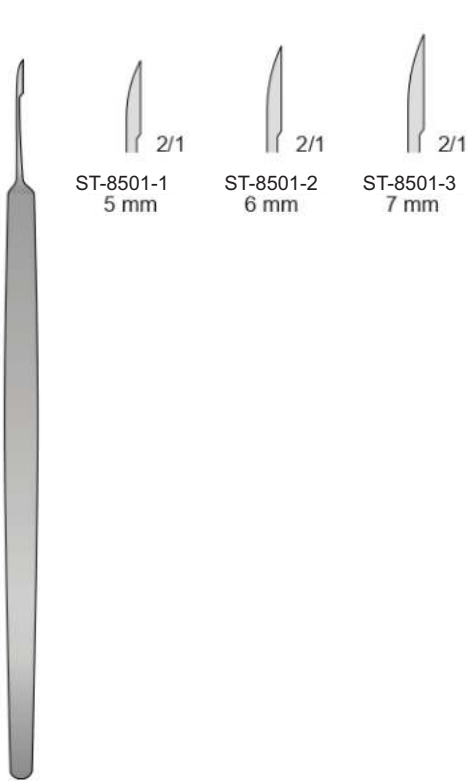
***Surgical
Instruments***



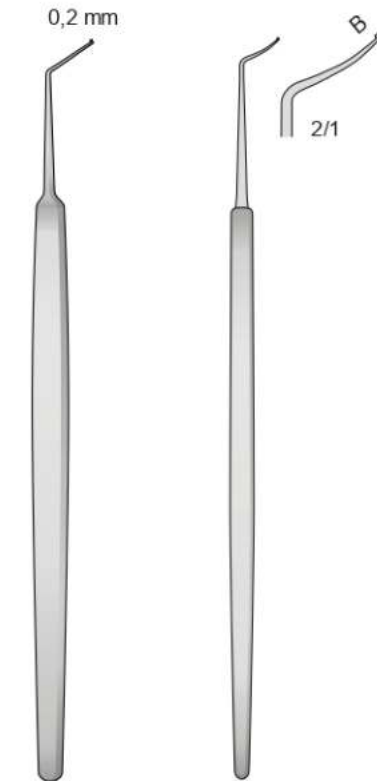
Ophthalmology



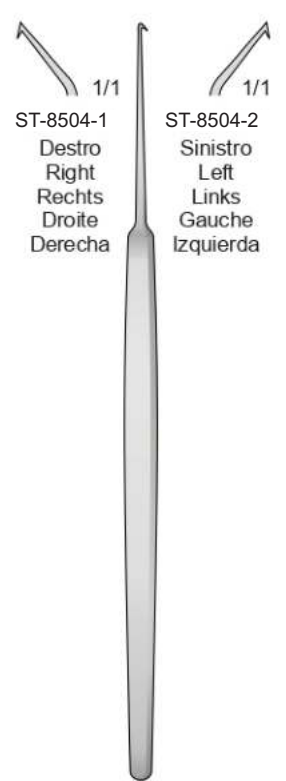
www.safetool.com.pk



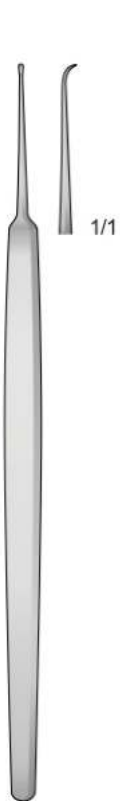
ZIEGLER
ST-8501
115 mm



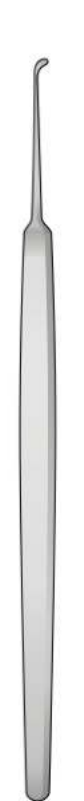
ST-8502
120 mm
ST-8503-1 0,2 mm
ST-8503-2 0,3 mm
125 mm
14-120



GRAEFE
ST-8504
130 mm



LA FORCE
ST-8505
120 mm



ELLIS
ST-8506
120 mm



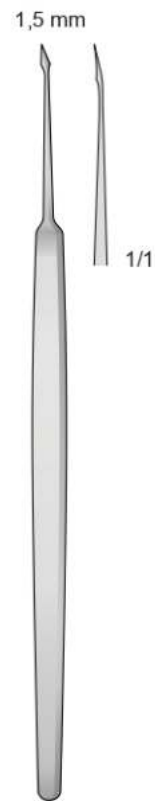
ST-8507
125 mm



ST-8508
125 mm



ST-8509
125 mm



ST-8510
125 mm



ST-8511
125 mm



ST-8512
125 mm



ST-8513
120 mm



ST-8514-1
35 mm



ST-8514-2
35 mm



ST-8515-1
125 mm



ST-8515-2
135 mm

GRAEFE
ST-8514
140 mm

GRAEFE
ST-8515



1/1



WECKER
ST-8516
130 mm

1,5 mm

2 mm

1 mm



1/1

ST-8516-1



1/1

ST-8516-2



1/1

ST-8516-3
Convergente
Convergent
Konvergent



GRAEFE
ST-8517
130 mm



1/1

ST-8517-1



1/1

ST-8517-2

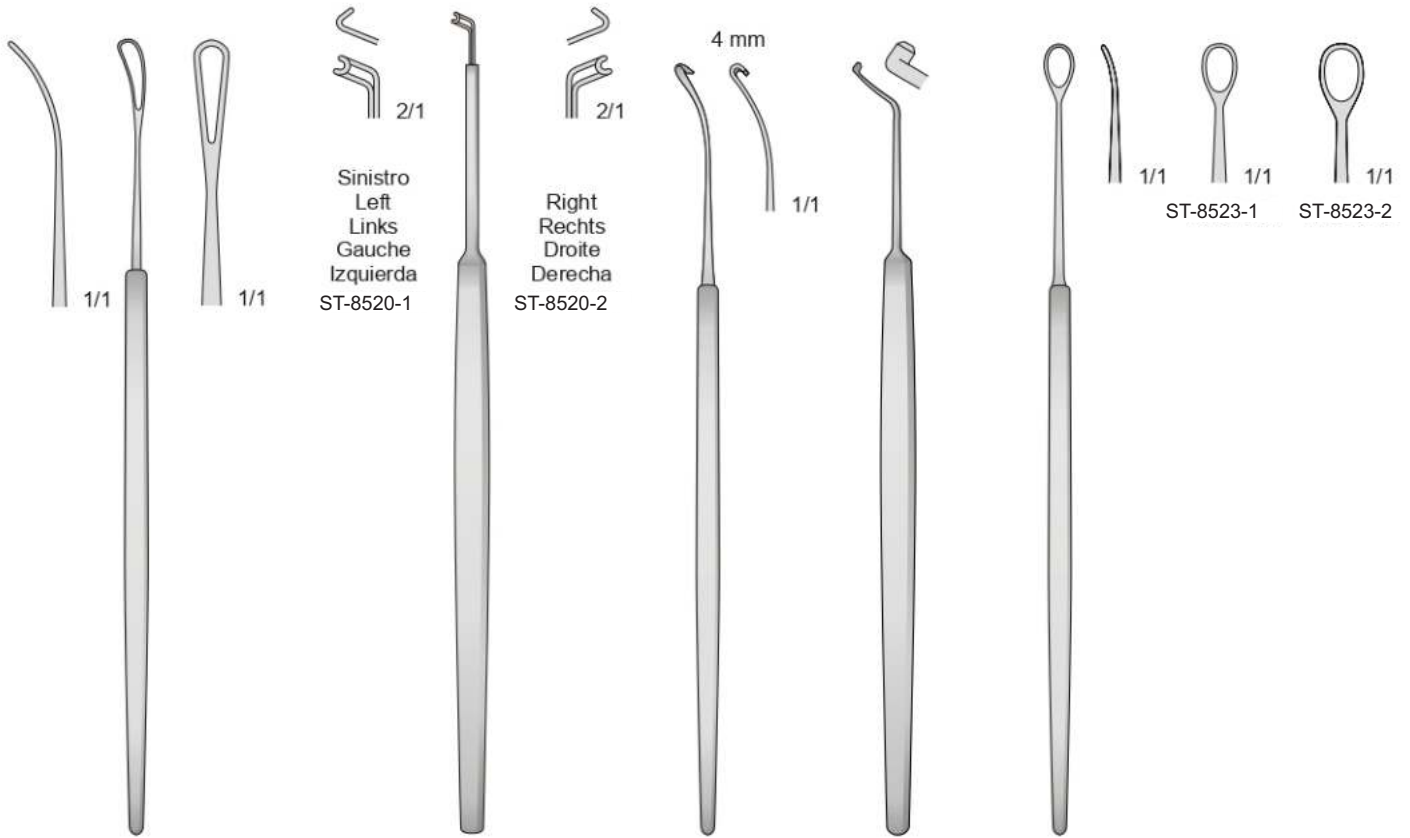
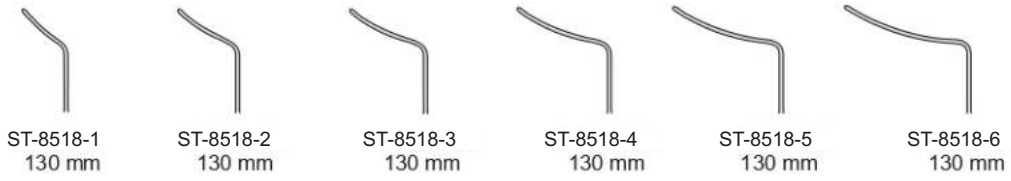


1/1

ST-8517-3



CASTROVIEJO
ST-8518



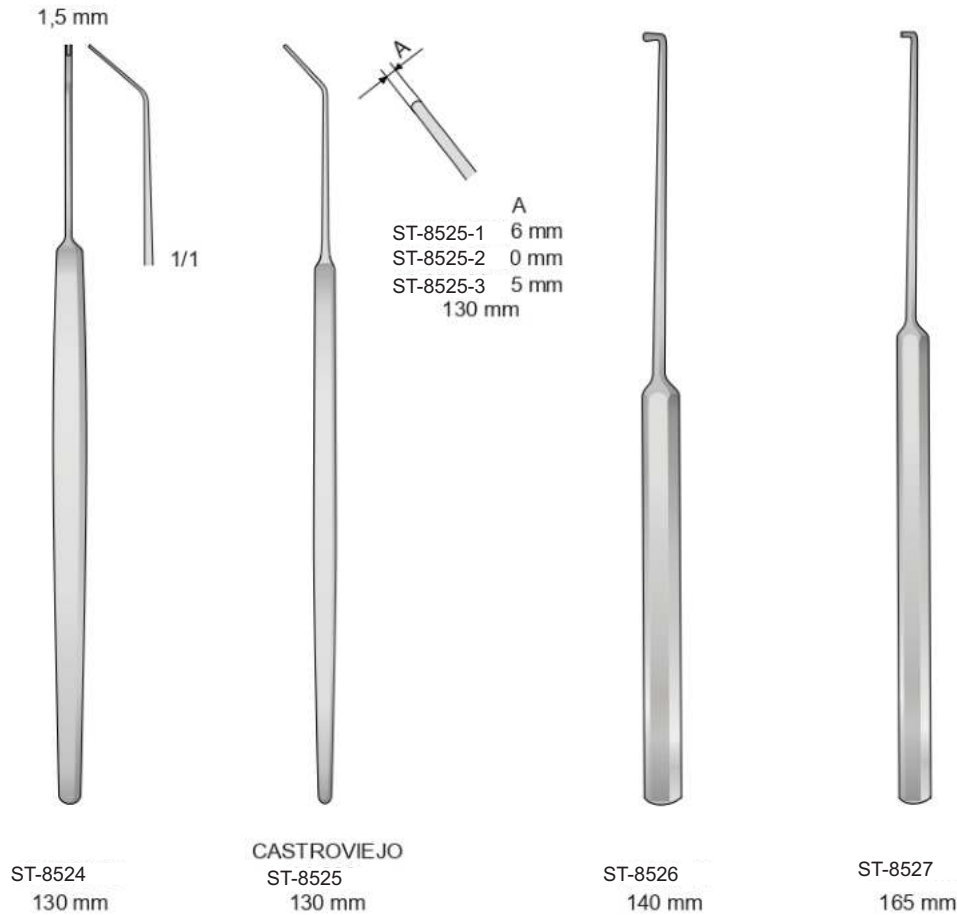
SNELLEN
ST-8519
135 mm

ST-8520
140 mm

ST-8521
130 mm

ST-8522
130 mm

WEBER
ST-8523
135 mm

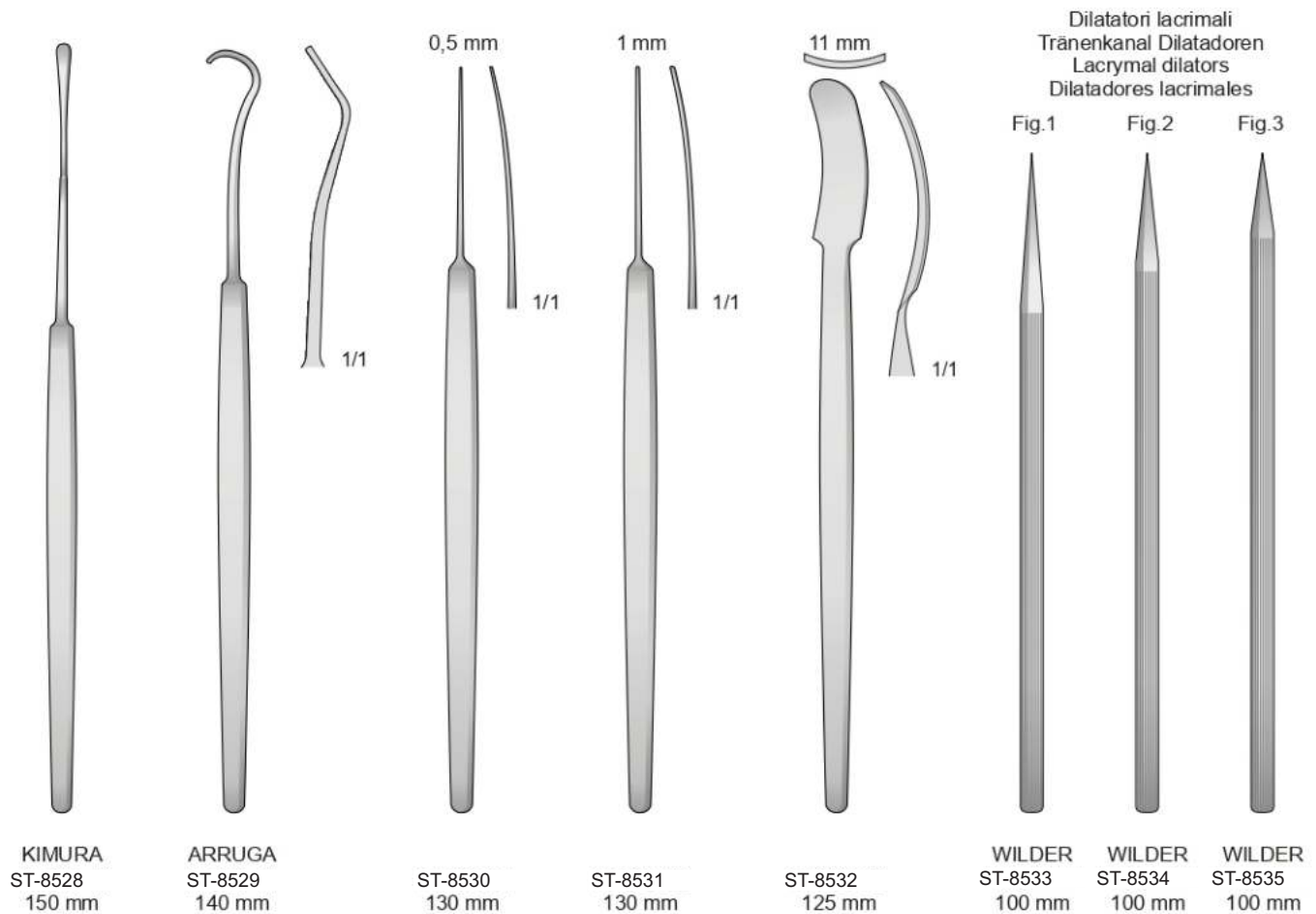


ST-8524
130 mm

CASTROVIEJO
ST-8525
130 mm

ST-8526
140 mm

ST-8527
165 mm



KIMURA
ST-8528
150 mm

ARRUGA
ST-8529
140 mm

ST-8530
130 mm

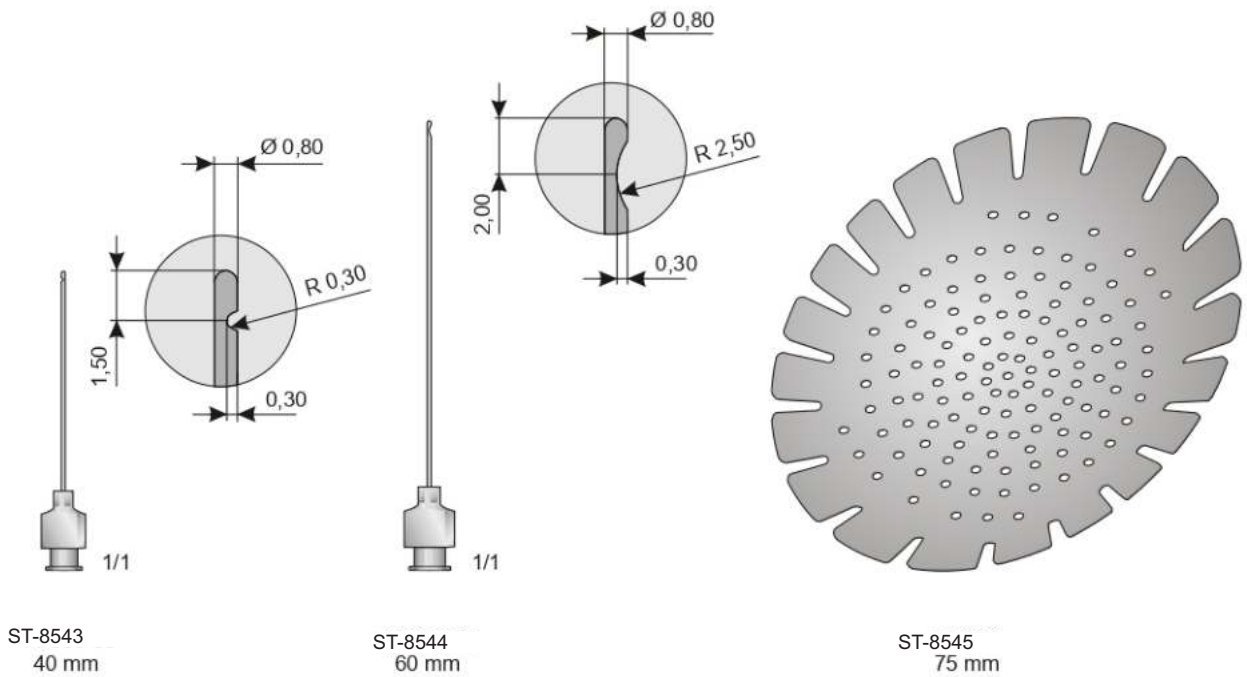
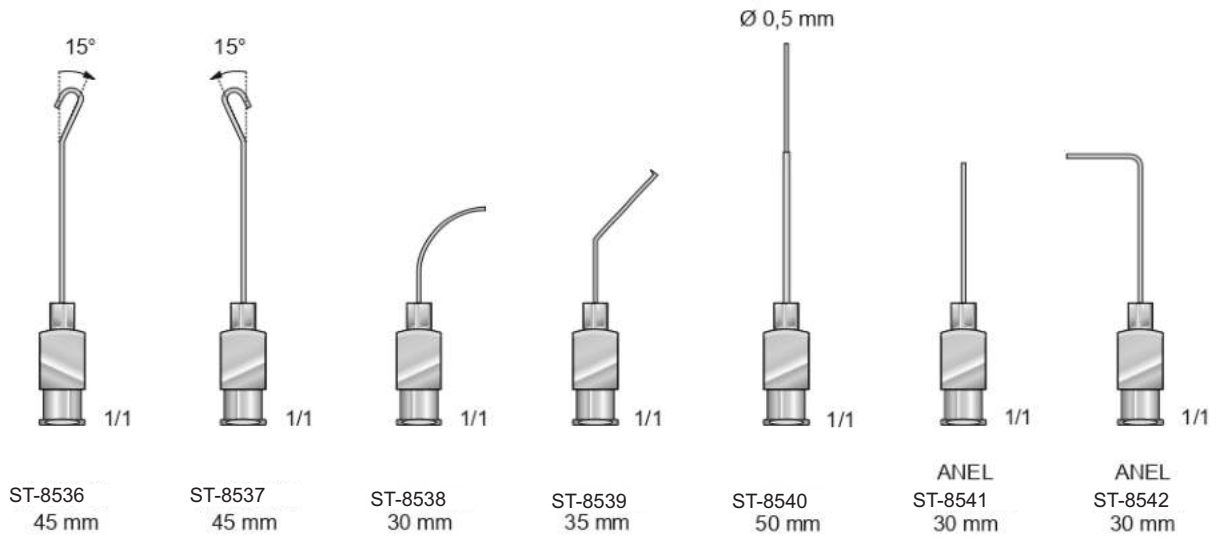
ST-8531
130 mm

ST-8532
125 mm

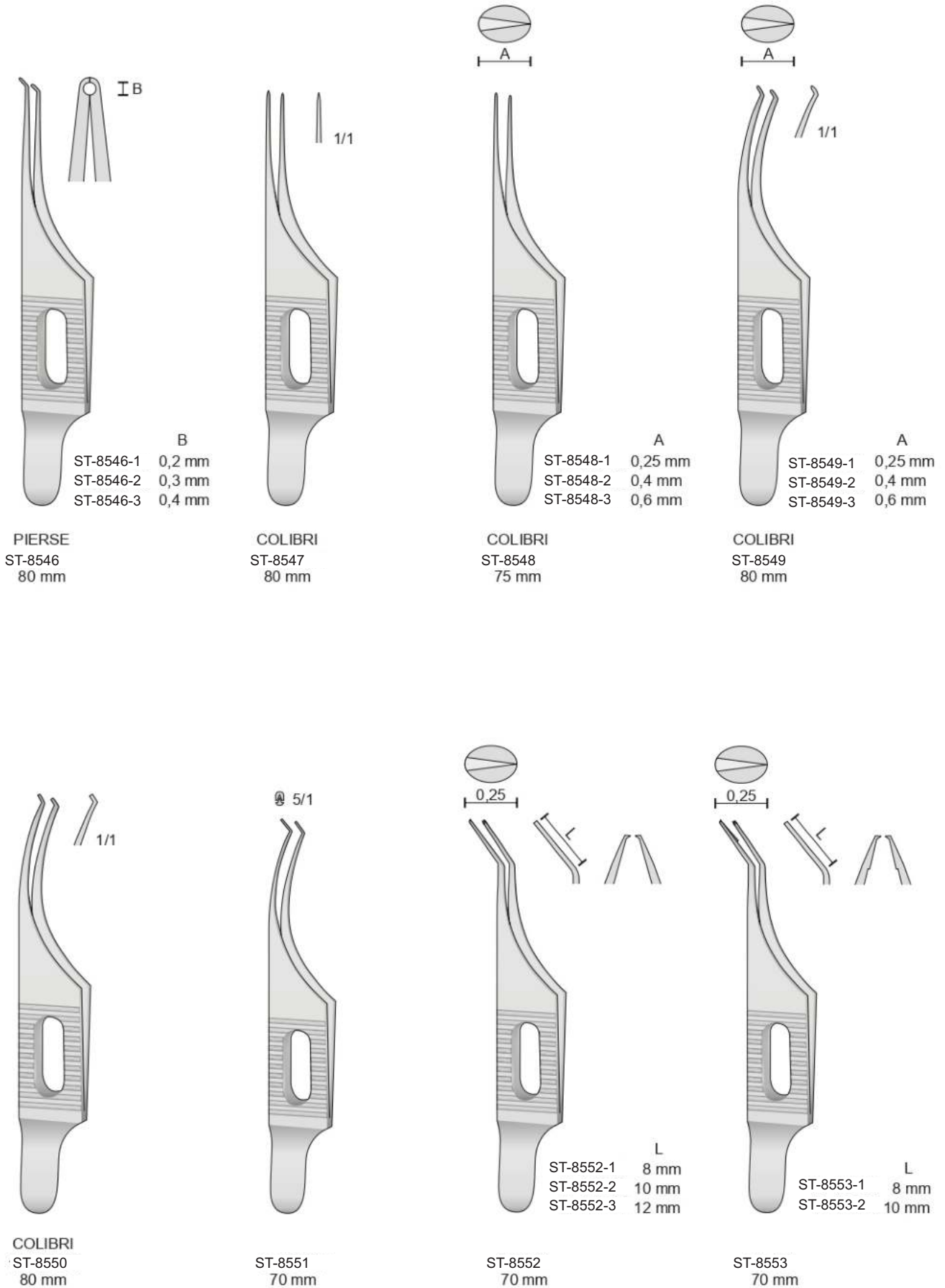
WILDER
ST-8533
100 mm

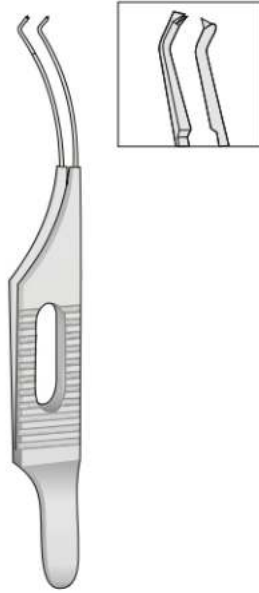
WILDER
ST-8534
100 mm

WILDER
ST-8535
100 mm

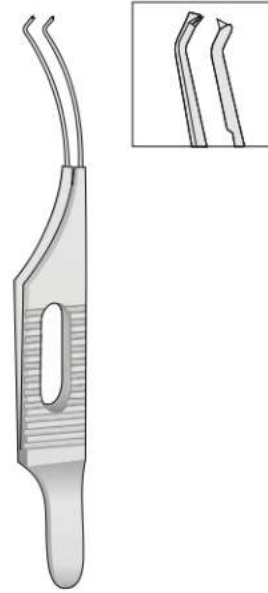


Micro Pinzette - Micro Forceps - Mikro Pinzetten - Micro pinces - Pinzas finos

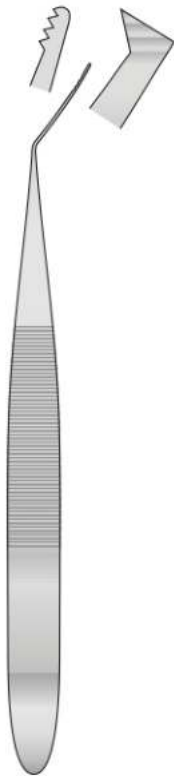




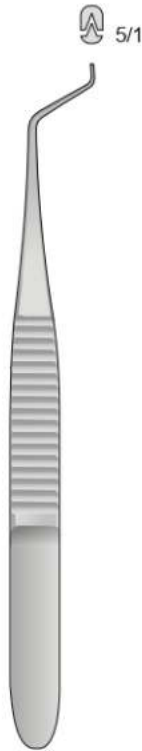
BARRAQUER
14-460-01



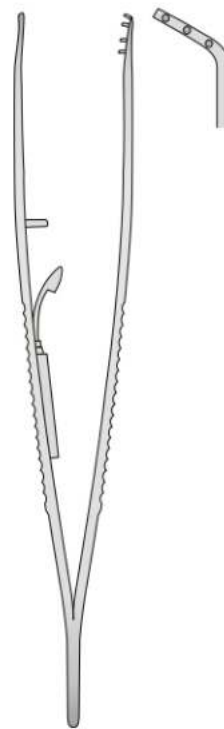
BARRAQUER
14-460-02



14-470-09
95 mm



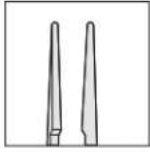
14-480-09
90 mm



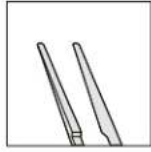
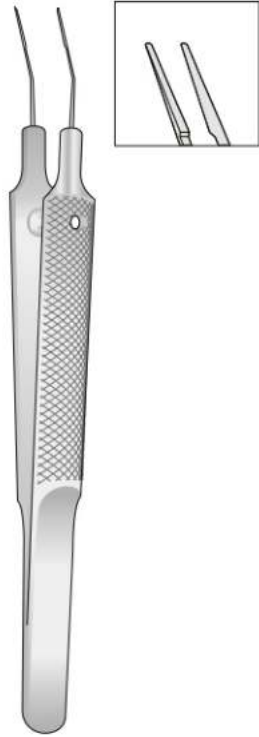
14-490-09
95 mm



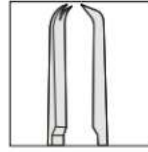
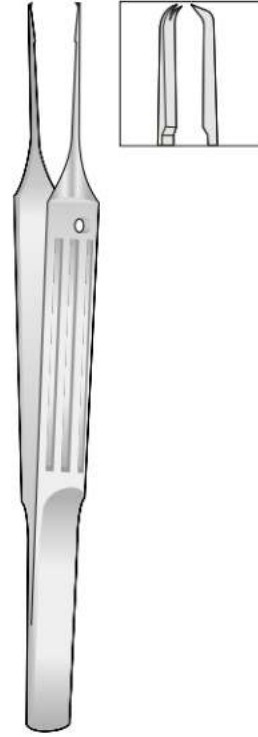
Mc PHERSON
14-500-09
95 mm



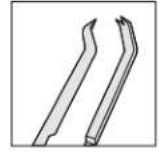
14-510-01



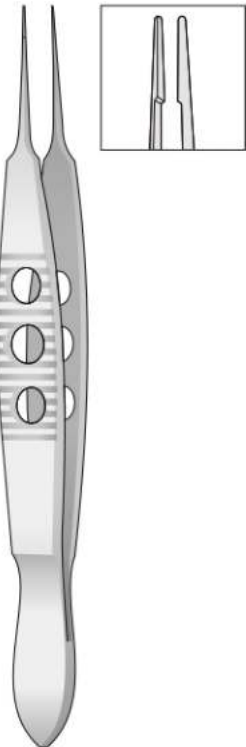
14-510-02



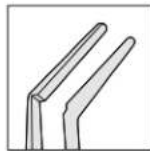
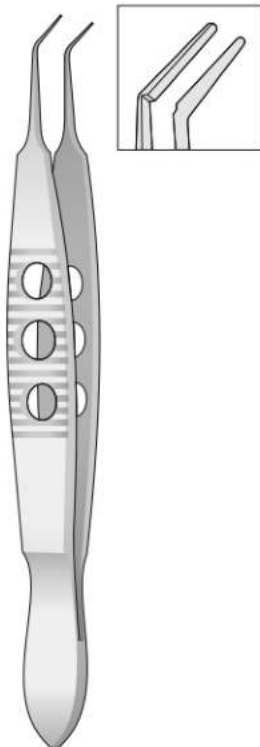
CASTROVIEJO
14-520-01



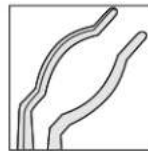
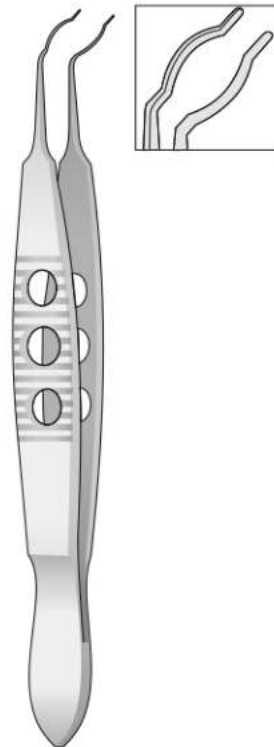
TROUTMAN
14-530-01



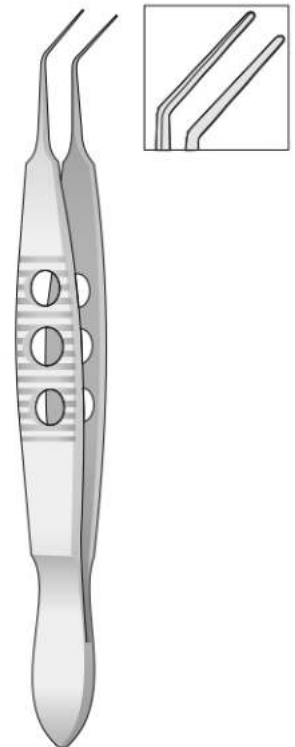
MC PHERSON
14-540-01



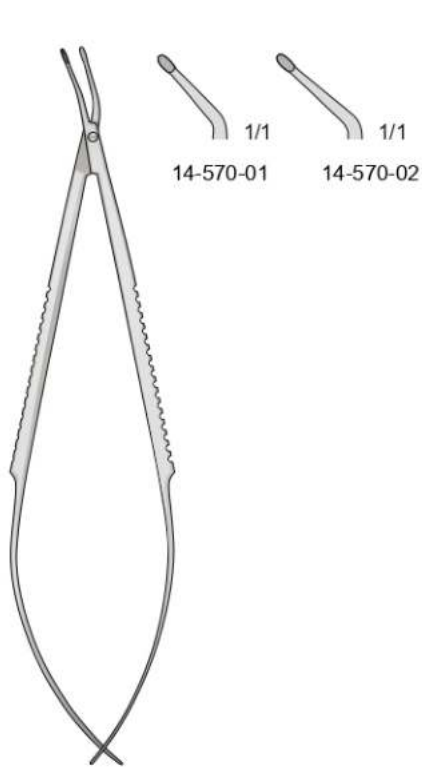
MC PHERSON
14-540-02



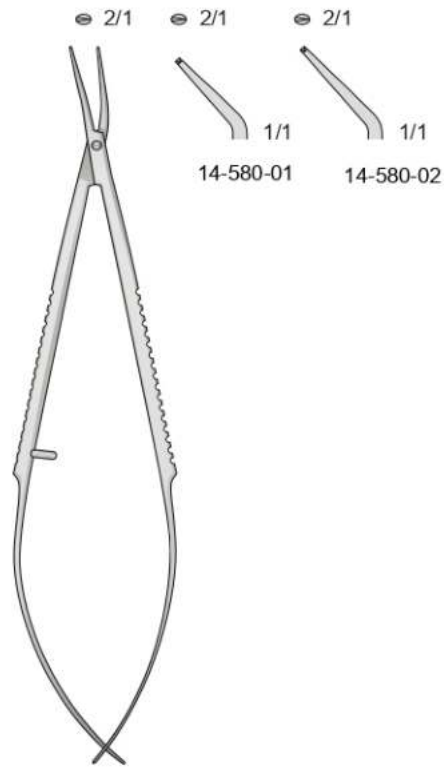
OSHIKA-FAULKNER
14-550-01



FAULKNER
14-560-01



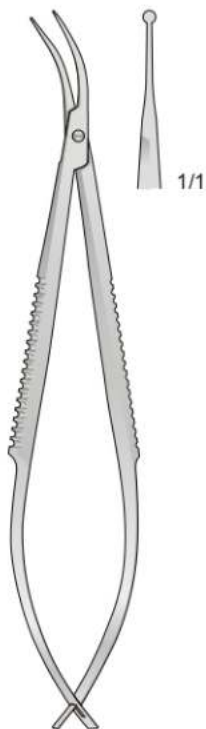
14-570
110 mm



14-580
110 mm



14-590-11
110 mm



14-600-01
110 mm

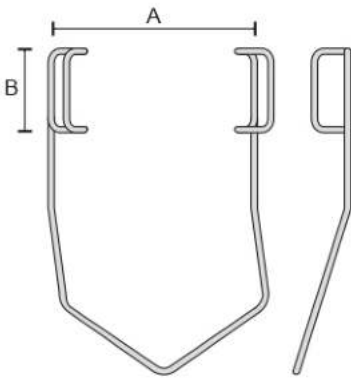


14-600-02
110 mm



14-600-03
110 mm

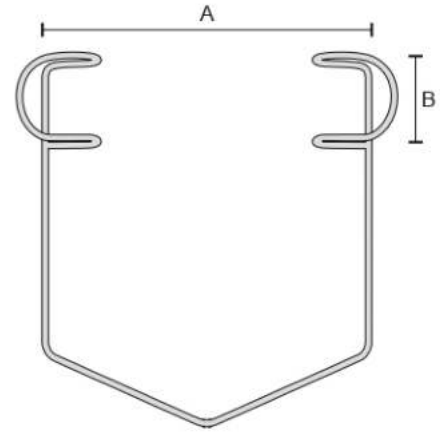
Blefarostati - Eye specula - Sperrelevatoren
Blèpharostats - Blefarostatos



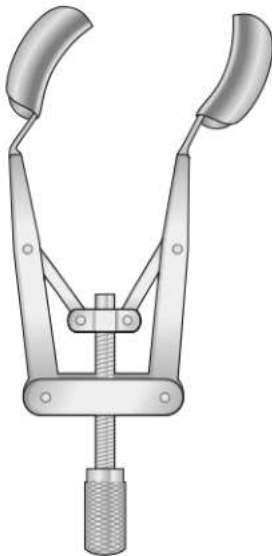
A B
14-610-01 27 mm 11 mm



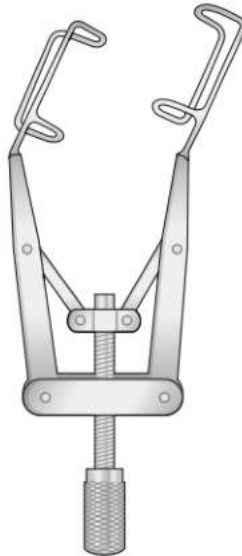
BARRAQUER
14-620-02



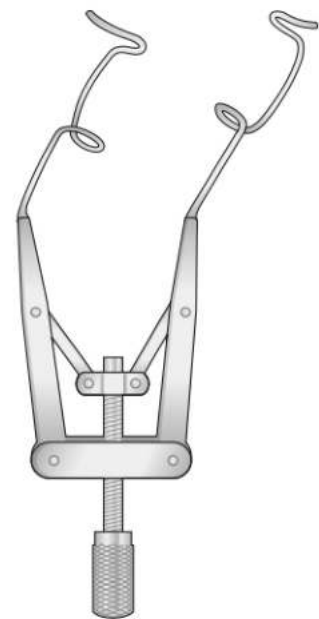
A B
14-630-01 27 mm 5 mm
14-630-02 34 mm 9 mm
14-630-03 42 mm 12 mm
14-630-04 42 mm 14 mm



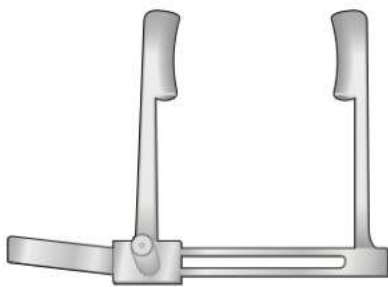
KERSHNER
14-640-01



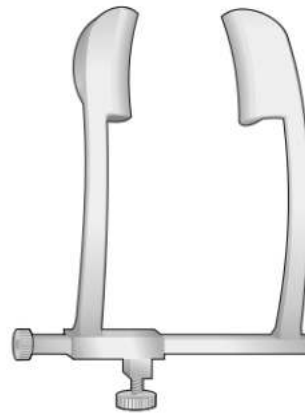
KERSHNER
14-640-02



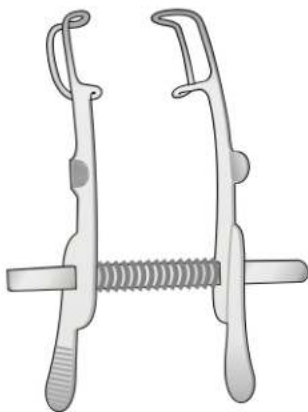
LIEBERMANN-TENNANT
14-650-01



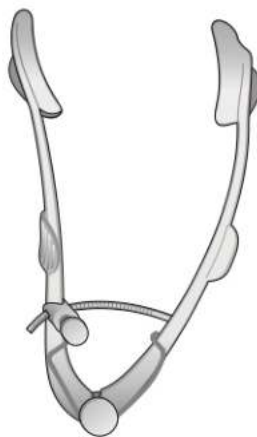
PROST
14-660



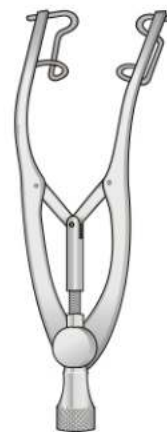
COOK
14-670



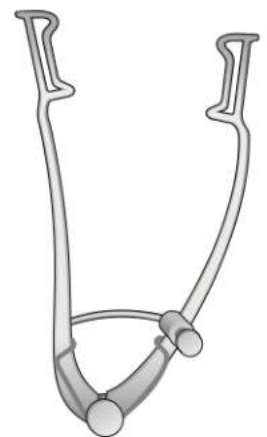
MELLINGER
14-680
70 mm



LISTER-BURCH
14-690
80 mm



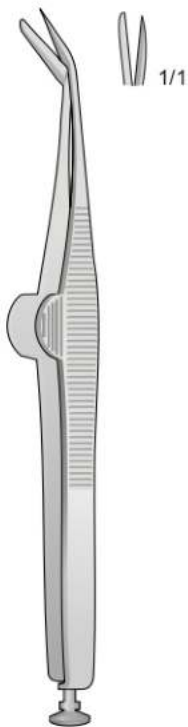
CASTROVIEJO
14-700
80 mm



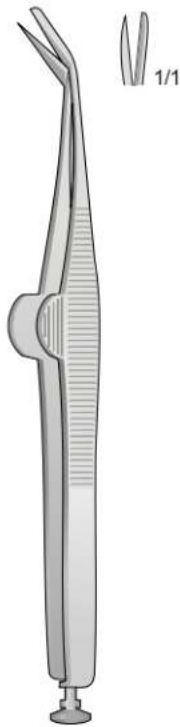
WILLIAMS
14-710
80 mm



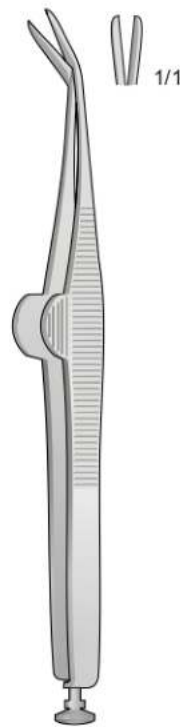
VANNAS
14-720
85 mm



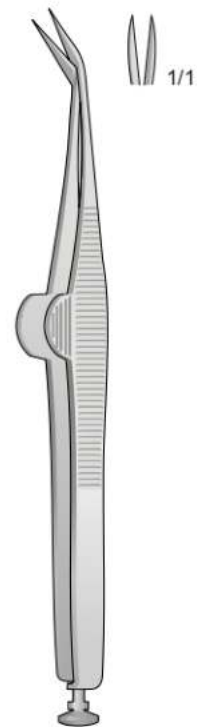
WECKER
14-730-01
110 mm



WECKER
14-730-02
110 mm



WECKER
14-730-03
110 mm



WECKER
14-730-04
110 mm



Acuta - Sharp - Spitz
Pointu - Agudas



NOYES
14-740-01
120 mm

Acuta - Sharp - Spitz
Pointu - Agudas



NOYES
14-740-02
120 mm

Acuta - Sharp - Spitz
Pointu - Agudas



WESTCOTT
14-750-01
120 mm

Acuta - Sharp - Spitz
Pointu - Agudas



WESTCOTT
14-750-02
120 mm

Smussa - Blunt - Stumpf
Mousse - Romas



WESTCOTT
14-760-01
120 mm

Smussa - Blunt - Stumpf
Mousse - Romas

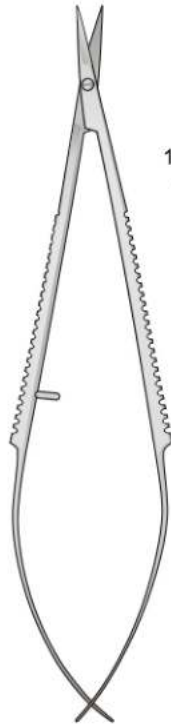
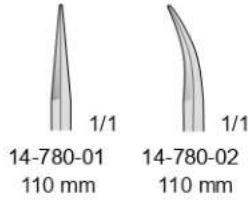


WESTCOTT
14-760-02
120 mm



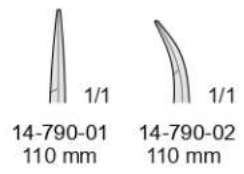
14-770-11
110 mm

Acuta - Sharp
Spitz - Pointu - Agudas



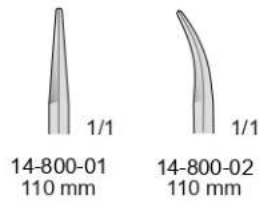
14-780
110 mm

Acuta - Sharp
Spitz - Pointu - Agudas



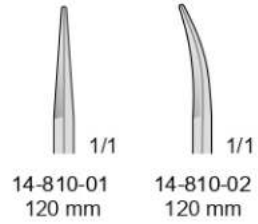
14-790
110 mm

Smussa - Blunt
Stumpf - Mousse - Romas

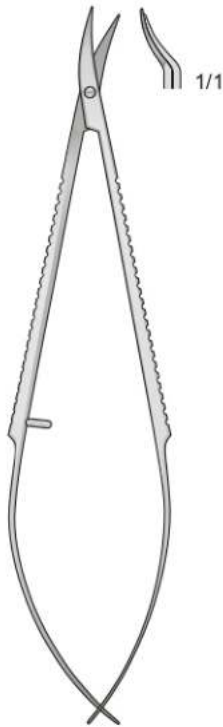


14-800
110 mm

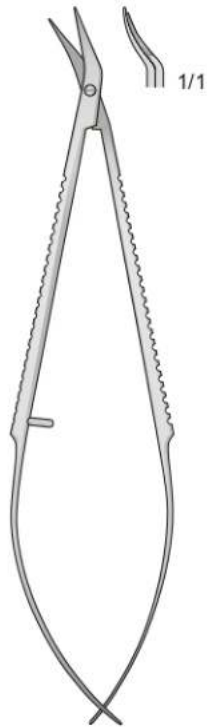
Smussa - Blunt
Stumpf - Mousse - Romas



14-810
120 mm



TROUTMAN
14-820-01
110 mm



TROUTMAN
14-820-02
110 mm



CASTROVIEJO
14-830-01
110 mm



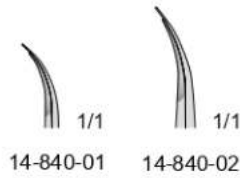
CASTROVIEJO
14-830-02
110 mm



CASTROVIEJO
14-830-03
110 mm



14-840
110 mm



14-840-01



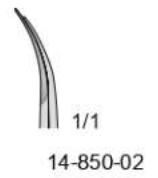
14-840-02



14-850
110 mm



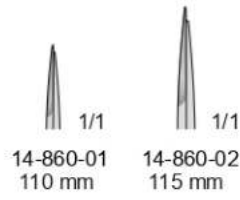
14-850-01



14-850-02



14-860



14-870-01
110 mm



14-870-02
110 mm



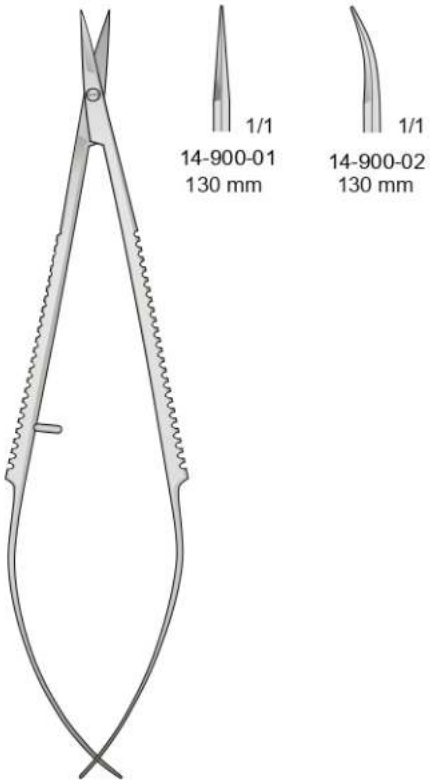
14-880-11
110 mm



14-890-11
110 mm

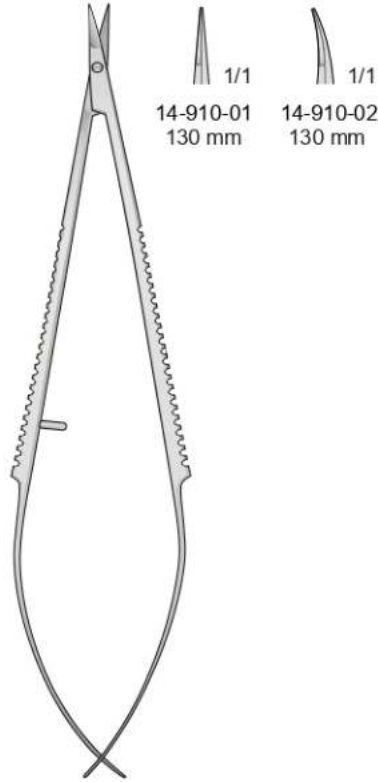


Acuta - Sharp - Spitz - Pointu - Agudas



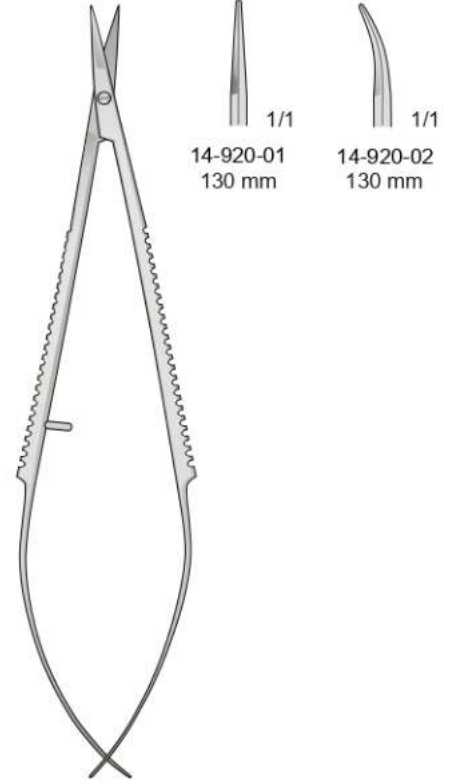
14-900
130 mm

Acuta - Sharp - Spitz - Pointu - Agudas



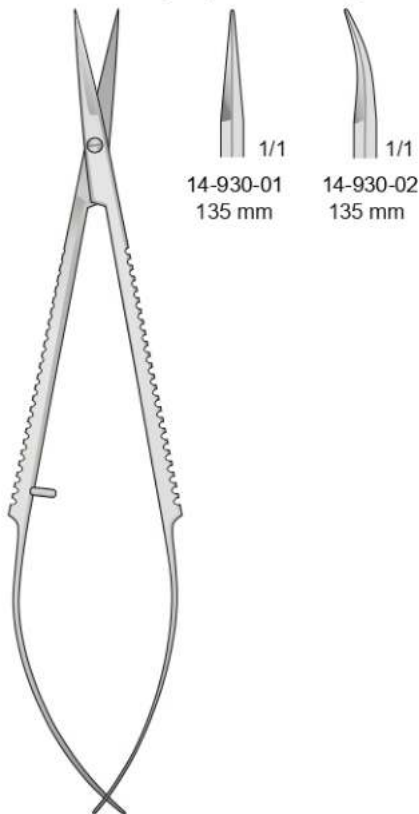
14-910
130 mm

Smussa - Blunt - Stumpf - Mousse - Romas



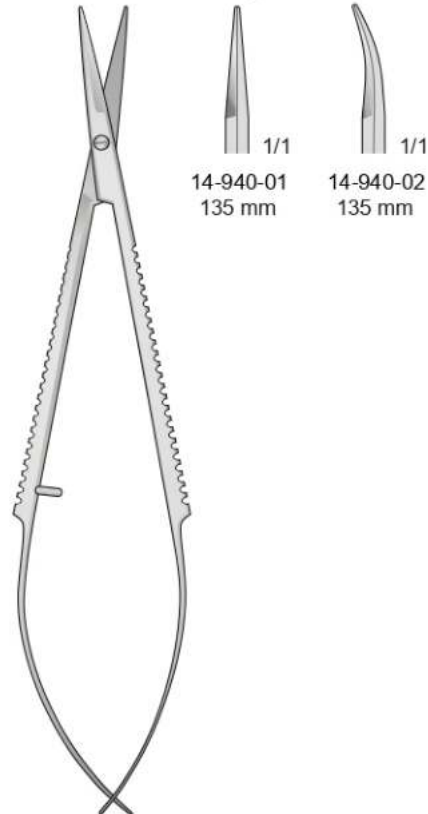
14-920
130 mm

Acuta - Sharp - Spitz - Pointu - Agudas



14-930
135 mm

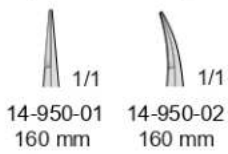
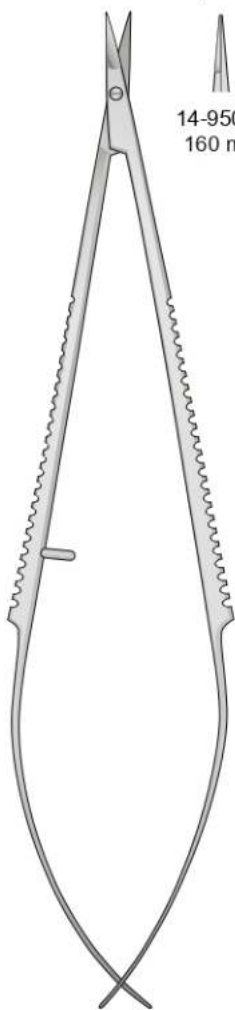
Smussa - Blunt - Stumpf - Mousse - Romas



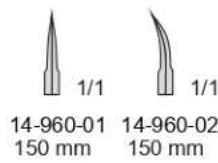
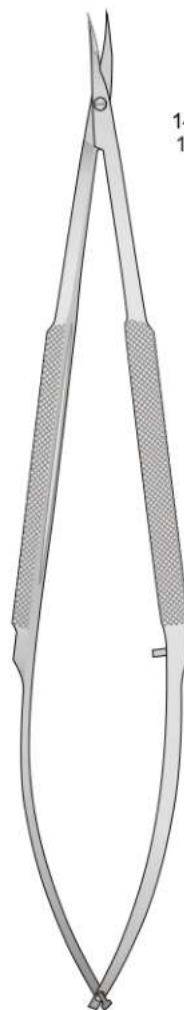
14-940
135 mm



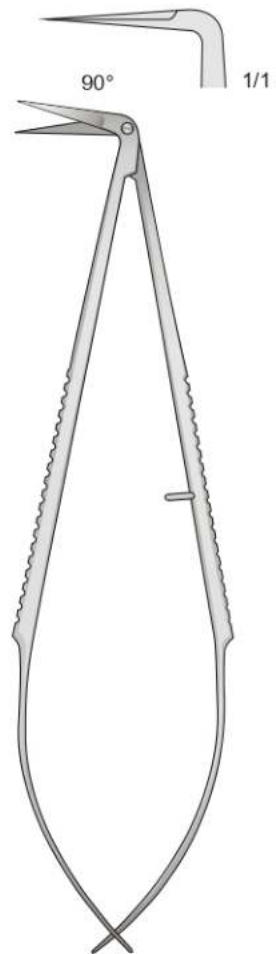
Acuta - Sharp
Spitz - Pointu - Agudas



14-950
160 mm



14-960
150 mm



90° 1/1

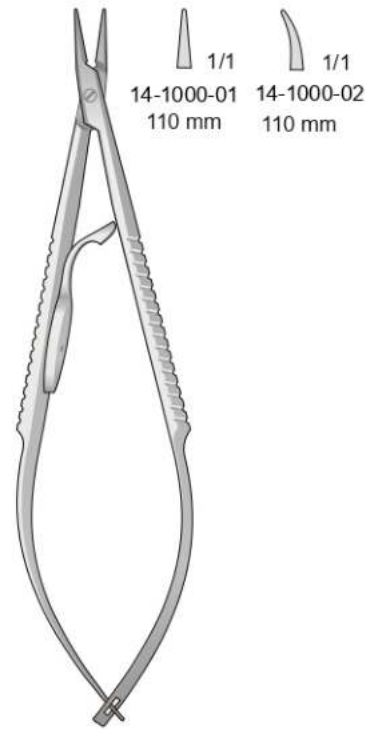
14-970
150 mm



14-980
110 mm



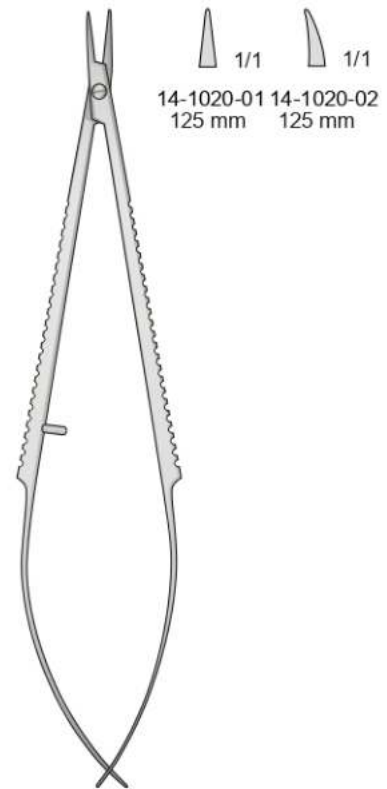
14-990
110 mm



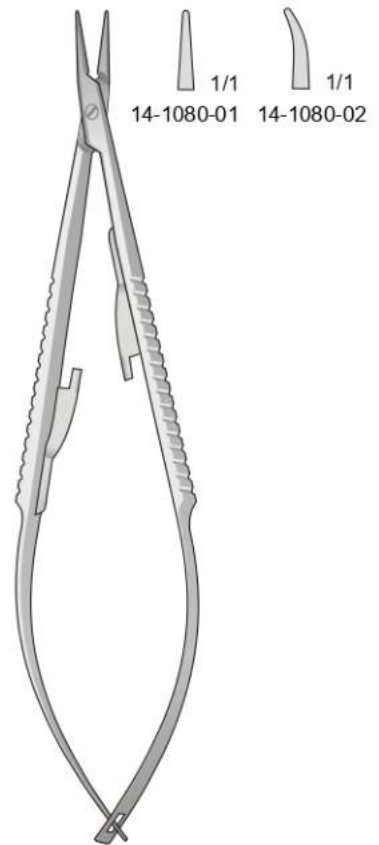
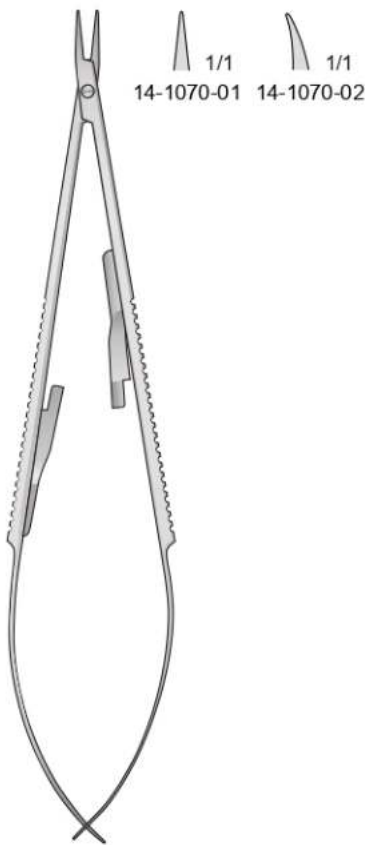
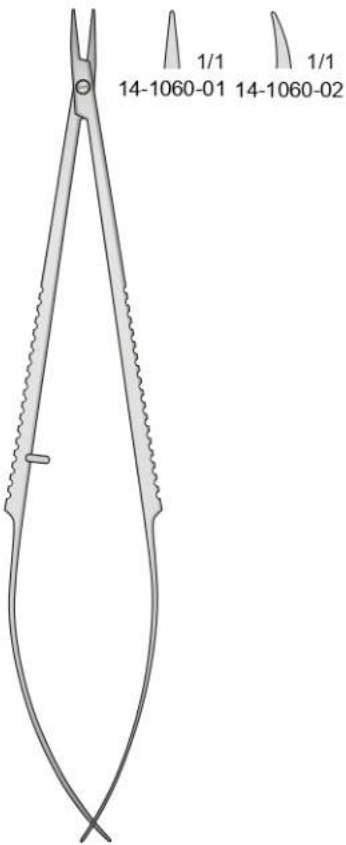
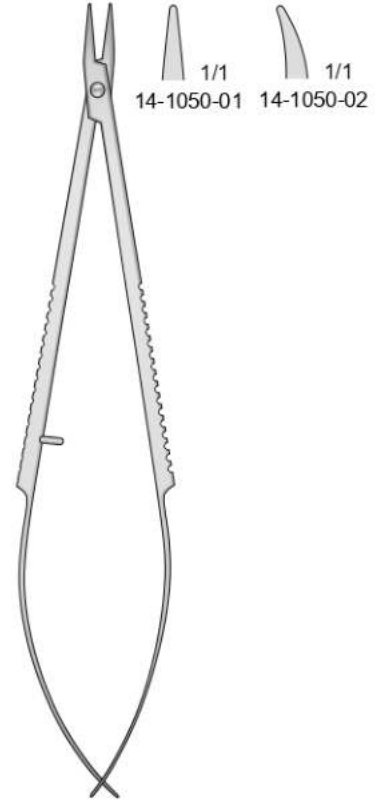
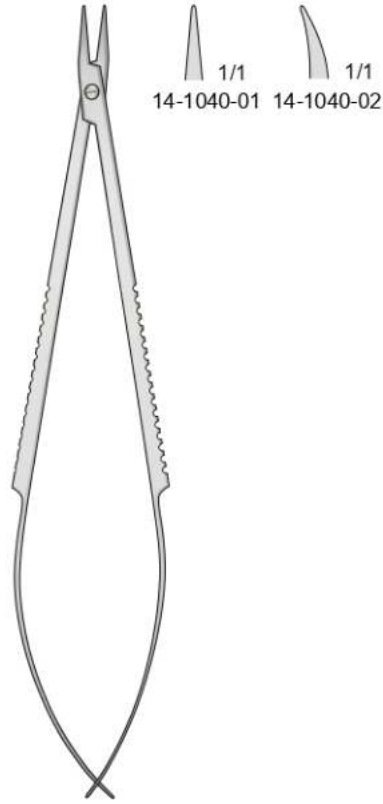
14-1000
110 mm

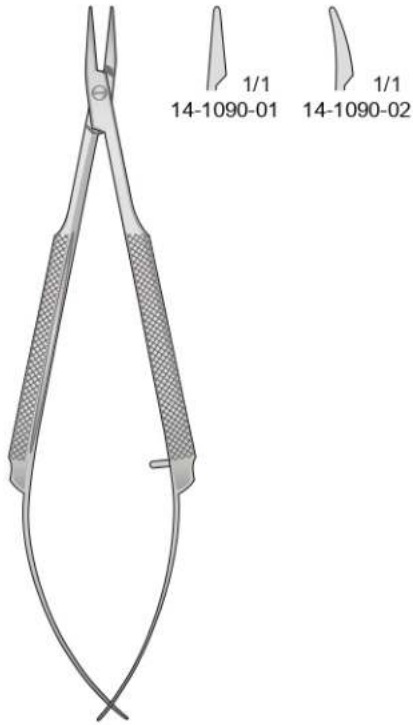


14-1010
125 mm



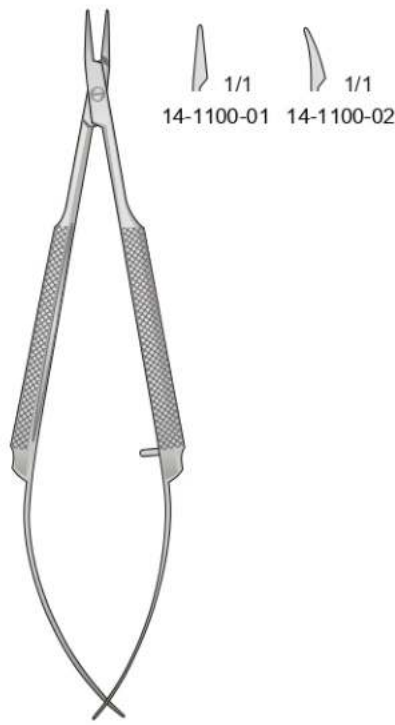
14-1020
125 mm





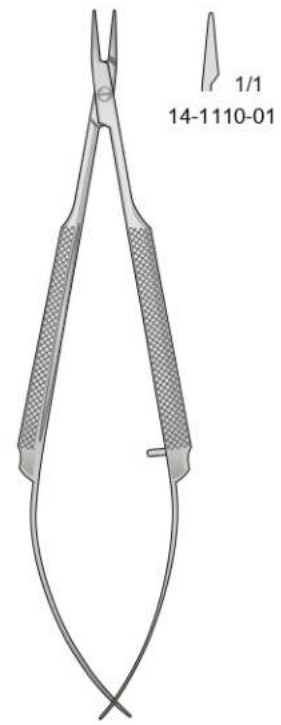
14-1090-01 1/1 14-1090-02 1/1

CASTROVIEJO
14-1090
110 mm



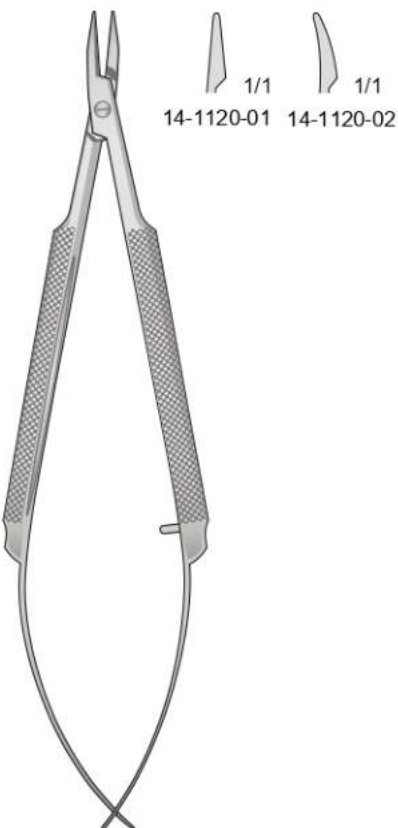
14-1100-01 1/1 14-1100-02 1/1

CASTROVIEJO
14-1100
110 mm



14-1110-01 1/1

CASTROVIEJO
14-1110
110 mm



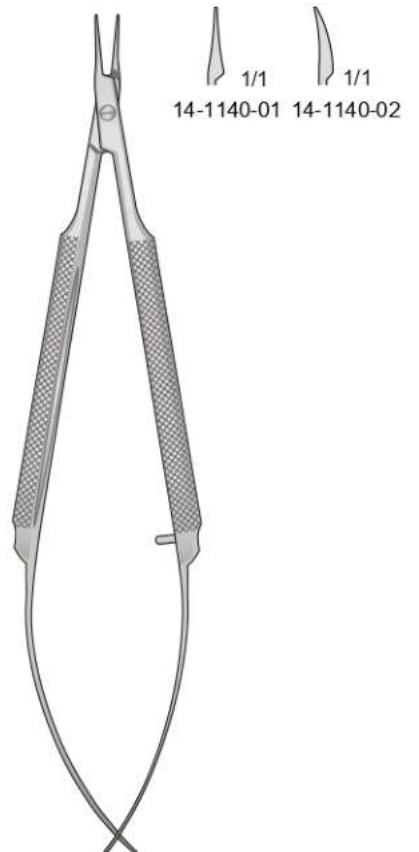
14-1120-01 1/1 14-1120-02 1/1

CASTROVIEJO
14-1120
125 mm



14-1130-01 1/1 14-1130-02 1/1

CASTROVIEJO
14-1130
125 mm



14-1140-01 1/1 14-1140-02 1/1

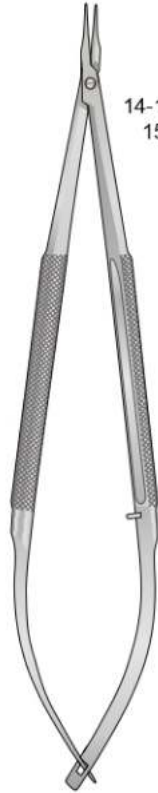
BARRAQUER
14-1140
125 mm



14-1150-01
125 mm

14-1150-02
125 mm

BARRAQUER
14-1150
125 mm



14-1160-01
150 mm

14-1160-02
150 mm

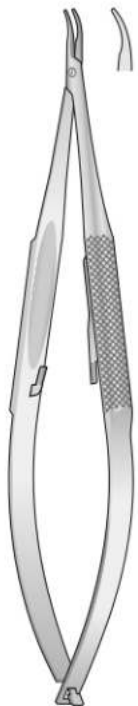
BARRAQUER
14-1160
150 mm



14-1170-01
150 mm

14-1170-02
150 mm

REILL
14-1170
150 mm



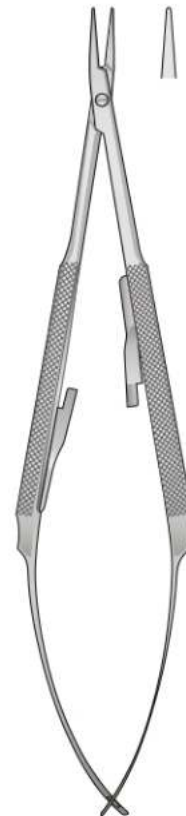
1/1

BARRAQUER
14-1180
120 mm



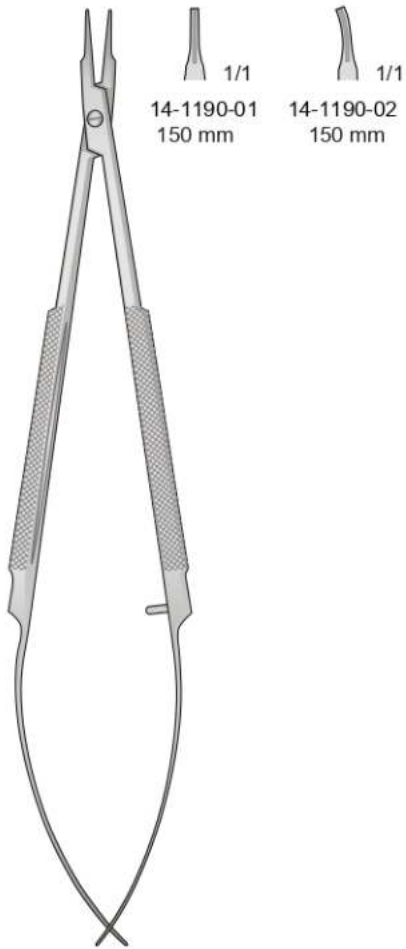
1/1

BARRAQUER
14-1180-02
125 mm

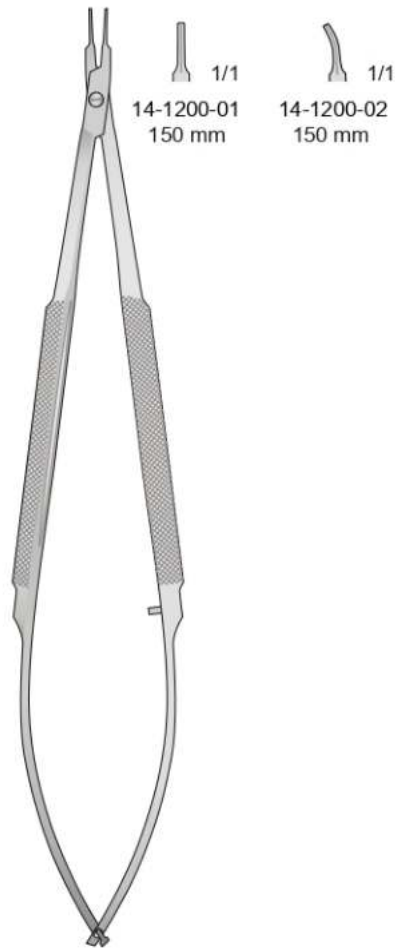


1/1

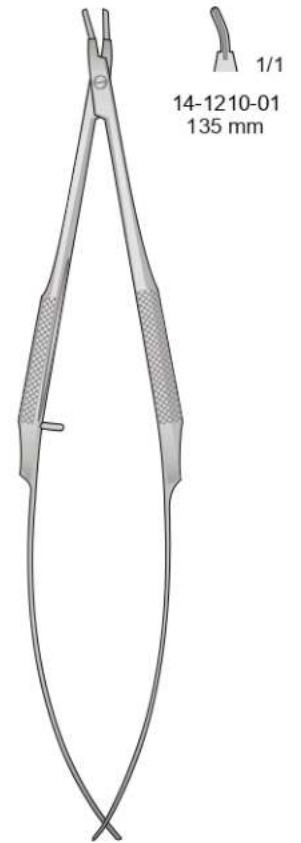
BARRAQUER
14-1180-03
150 mm



BARRAQUER
14-1190
150 mm



BARRAQUER
14-1200
150 mm

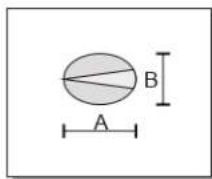


BARRAQUER
14-1210
135 mm

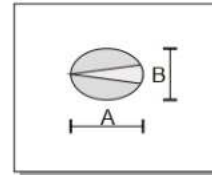
Micro pinzette
Micro forceps
Mikro Pinzetten
Micro pinces
Pinzas finos

1 x 2 Denti
1 x 2 Teeth
1 x 2 Zähne
1 x 2 Dents
1 x 2 Dientes

1 x 2 Denti
1 x 2 Teeth
1 x 2 Zähne
1 x 2 Dents
1 x 2 Dientes



A	B		
0,4	0,25	14-1220-01	14-1230-01
0,5	0,35	14-1220-02	14-1230-02
0,7	0,55	14-1220-03	14-1230-03
1	0,8	14-1220-04	14-1230-04
1,2	0,9	14-1220-05	14-1230-05
		95 mm	95 mm



Micro pinzette
Micro forceps
Mikro Pinzetten
Micro pincers
Pinzas finos

1 x 2 Denti
1 x 2 Teeth
1 x 2 Zähne
1 x 2 Dents
1 x 2 Dientes

1 x 2 Denti
1 x 2 Teeth
1 x 2 Zähne
1 x 2 Dents
1 x 2 Dientes

Acuta
Sharp
Spitz
Pointu
Agudas



Smussa
Blunt
Stumpf
Mousse
Romos



14-1240-01 14-1240-02



14-1250-01 14-1250-02



1/1

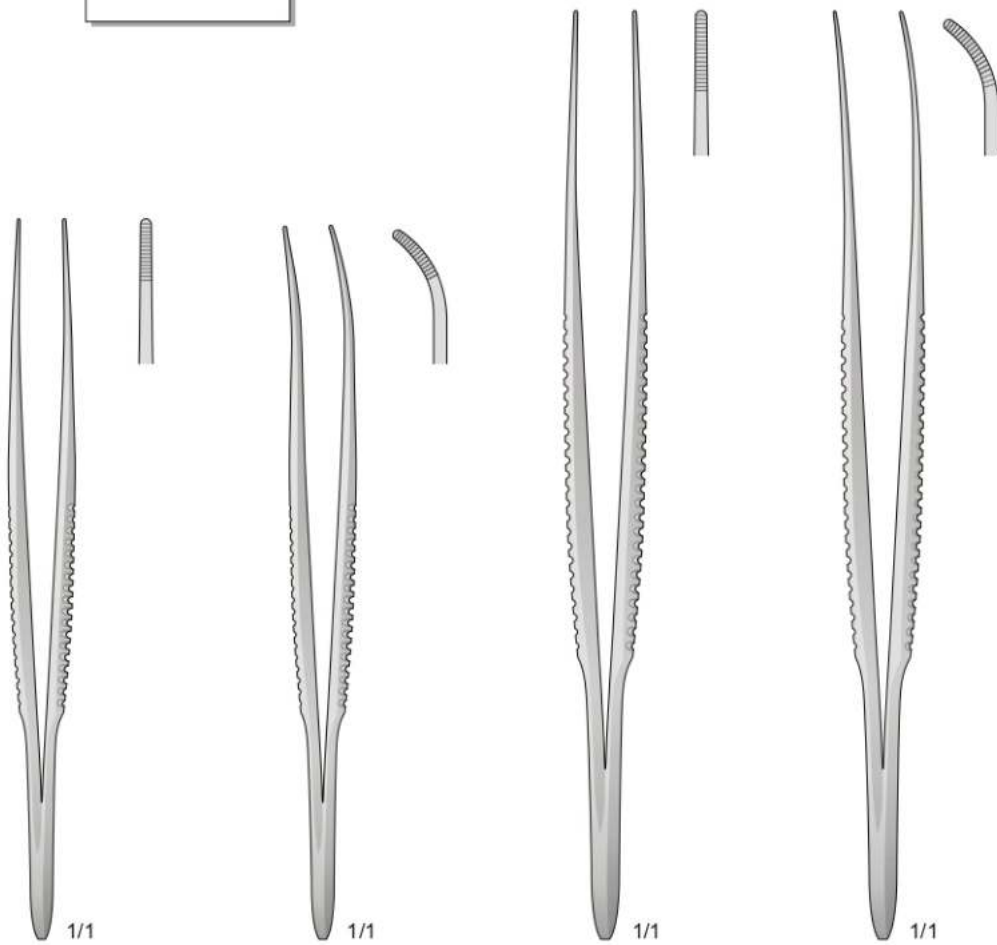
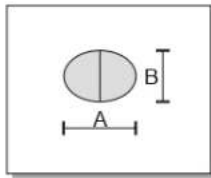


1/1

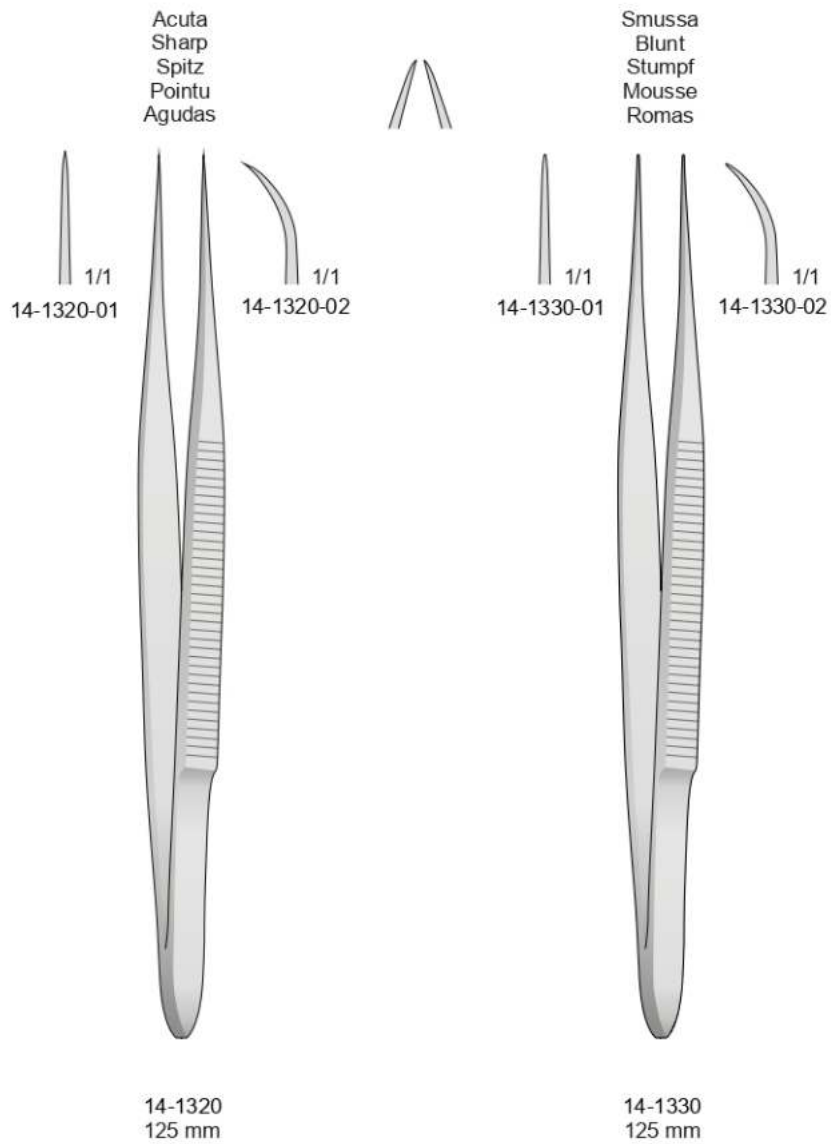
14-1240
95 mm

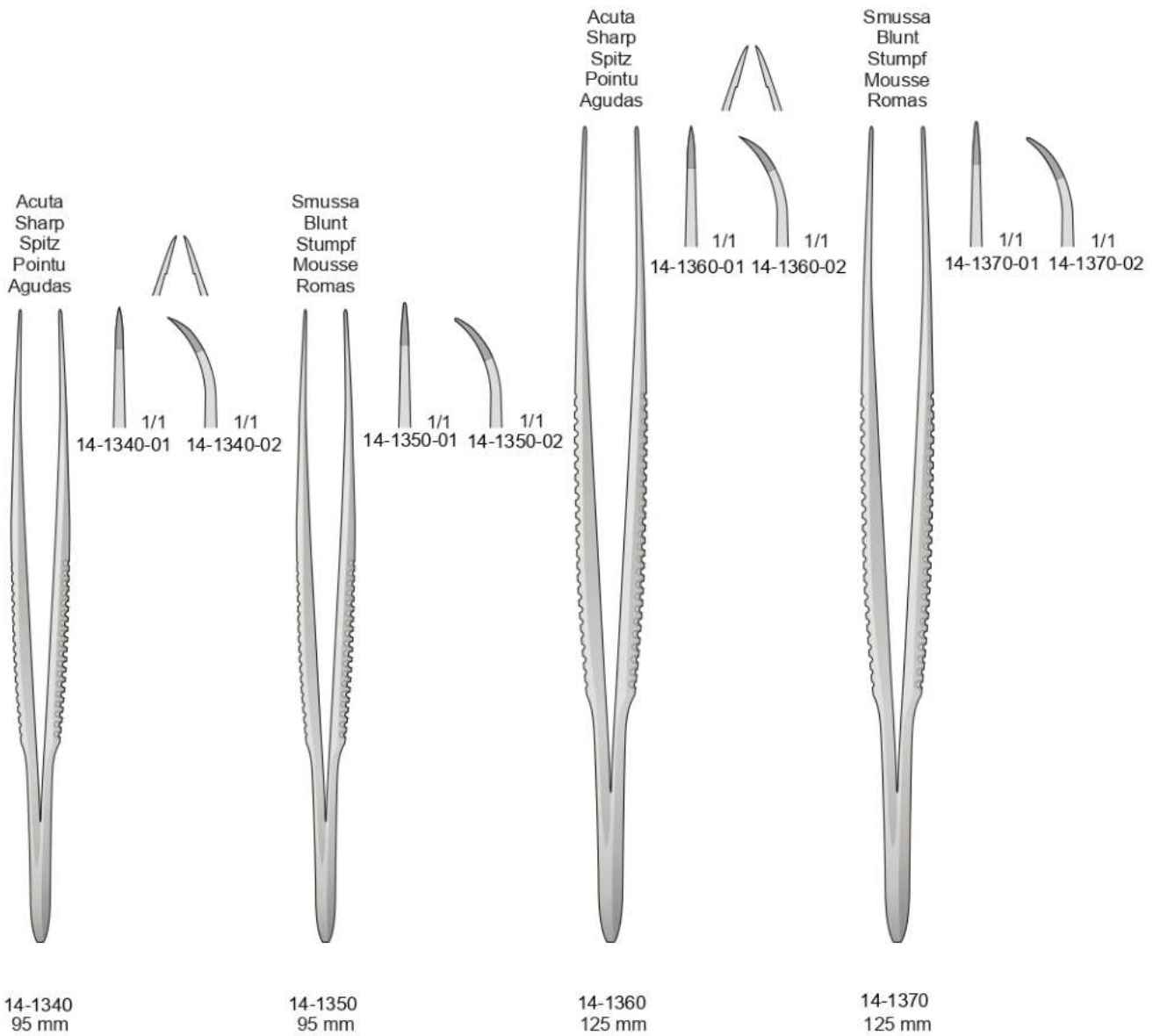
14-1250
95 mm

A	B		
0,4	0,25	14-1260-01	14-1270-01
0,5	0,35	14-1260-02	14-1270-02
0,7	0,55	14-1260-03	14-1270-03
1	0,8	14-1260-04	14-1270-04
1,2	0,9	14-1260-05	14-1270-05
		125 mm	125 mm

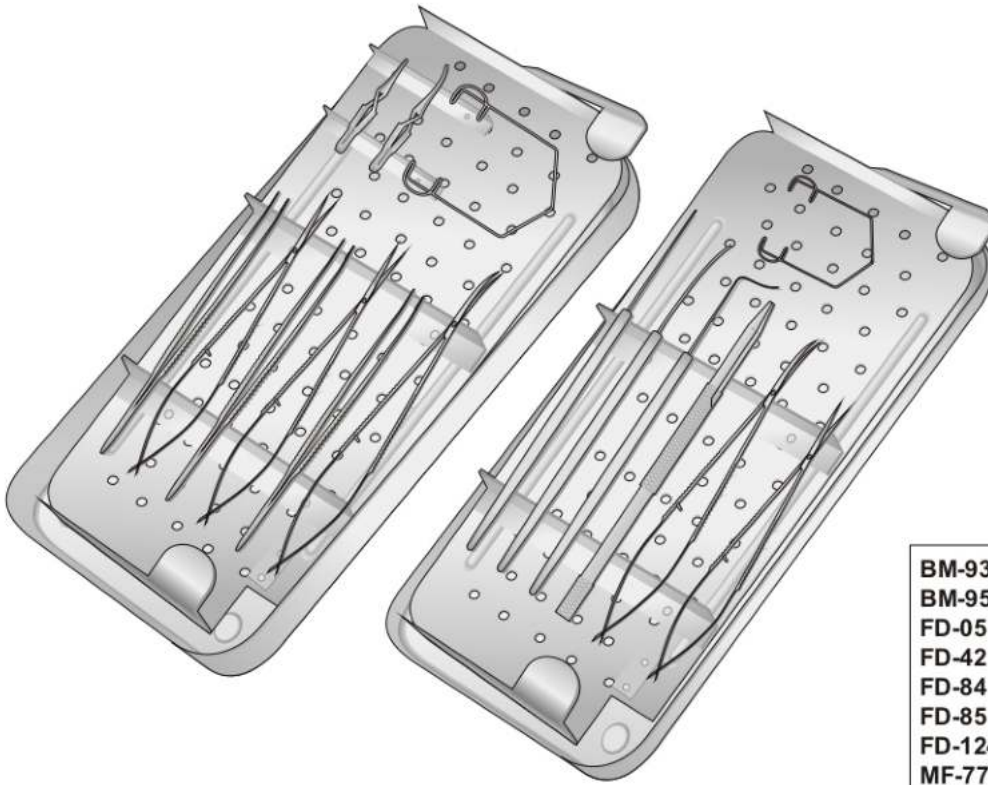


A	B				
0,5	0,4	14-1280-01	14-1290-01	14-1300-01	14-1310-01
0,6	0,5	14-1280-02	14-1290-02	14-1300-02	14-1310-02
0,9	0,7	14-1280-03	14-1290-03	14-1300-03	14-1310-03
1,3	1	14-1280-04	14-1290-04	14-1300-04	14-1310-04
1,6	1,3	14-1280-05	14-1290-05	14-1300-05	14-1310-05
		95 mm	95 mm	125 mm	125 mm





Set microchirurgia oftalmica



Consisting

- BM-93** - Bulldog diritta cm. 4
- BM-95** - Bulldog diritta cm. 4,5
- FD-05** - Micro forbice curva cm. 11
- FD-42** - Micro forbice curva cm. 12
- FD-84** - Micro pinzetta diritta cm. 11
- FD-85** - Micro pinzetta curva cm. 11
- FD-124** - Micro pinzetta 1x2 denti cm. 11
- MF-77** - Micro pinzetta diritta cm. 9,5
- MF-79** - Micro pinzetta diritta cm. 9,5
- NK-12** - Porta lame per micro cm. 12
- NK-18** - Micro bisturi Graefe cm. 13
- NK-23** - Micro divar. Castrovejo cm. 13
- NK-28** - Micro spatole Wecker cm. 13
- NK-60** - Micro pinzetta Colibri cm. 8
- NK-80** - Blefarostato Barraquer mm. 27x5

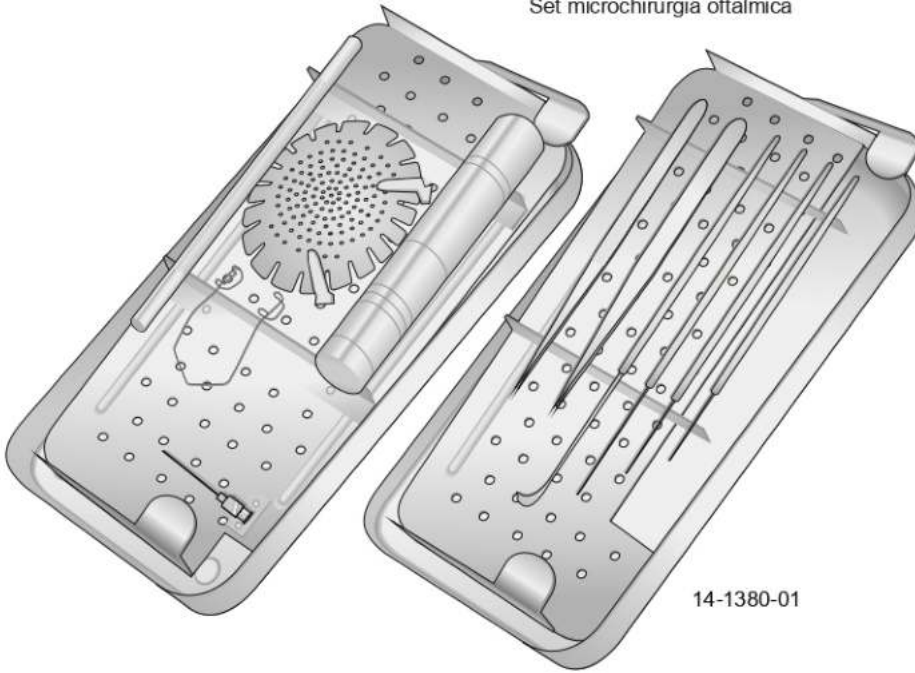


Consisting

- BT-16** - Micro divar. Gillies # 2
- DB-21** - Curette Day cm. 16
- FD-54** - Micro forbice curva cm. 16
- FD-135** - Micro forbice diritta cm. 16
- FD-158** - Micro port'aghi dir. cm. 15
- FD-159** - Micro port'aghi curvo cm. 15
- MF-58** - Micro pinzetta 1x2 denti cm. 15
- MF-64** - Micro pinzetta 1x2 denti cm. 15
- MF-93** - Micro pinzetta diritta cm. 15
- MF-94** - Micro pinzetta curva cm. 15



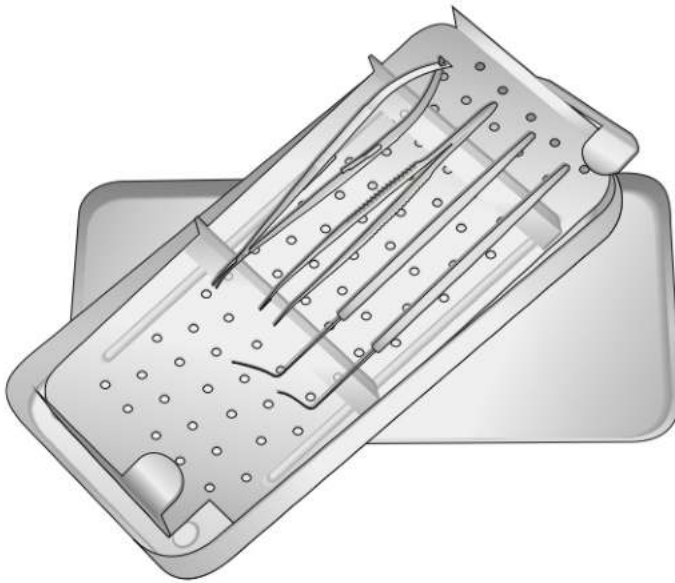
Set microchirurgia oftalmica



14-1380-01

14-1380
Consisting

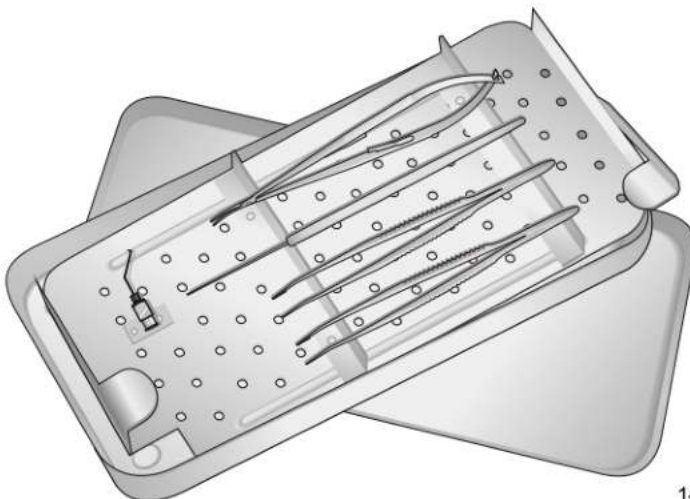
- Micro pinzetta cm. 12
- Div. Desmarres mm. 10
- Micro pinzetta cm. 8,5
- Bisturi Ellis cm. 12
- Spatola Kimura cm. 15
- Blefarostato Barraquer mm.27
- Dilatore Wilder #1
- Pseudo sfera piombo
- Occlusore alluminio mm. 75



14-1390-01

14-1390
Consisting

- Micro pinzetta cm. 12
- Micro pinzetta cm. 11
- Micro divaricatore mm. 0,2
- Uncino angolato cm. 13

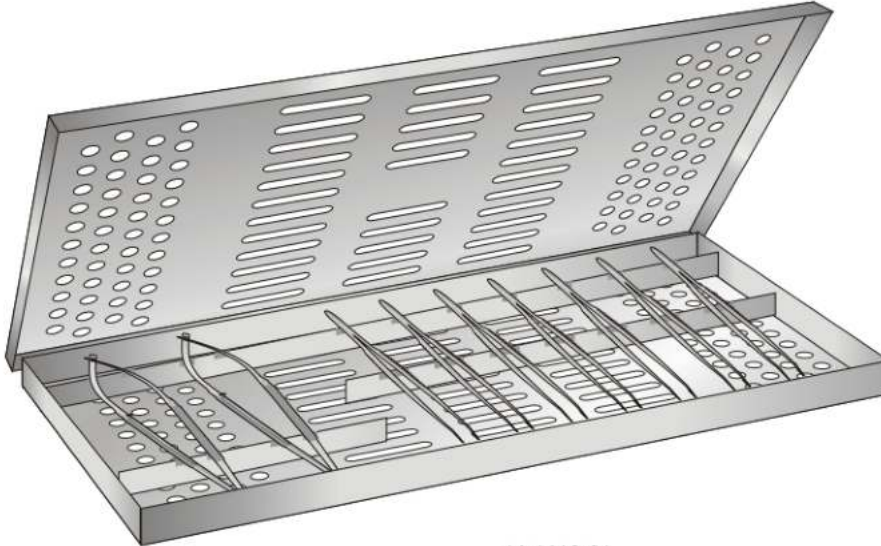


14-1400-01

14-1400
Consisting

- Micro pinzetta 1x2 denti cm. 9,5
- Micro pinzetta McPerson cm. 9,5
- Micro pinzetta cristallino cm. 11
- Micro spatola mm. 0,2
- Ago lacrimale curvo mm. 35

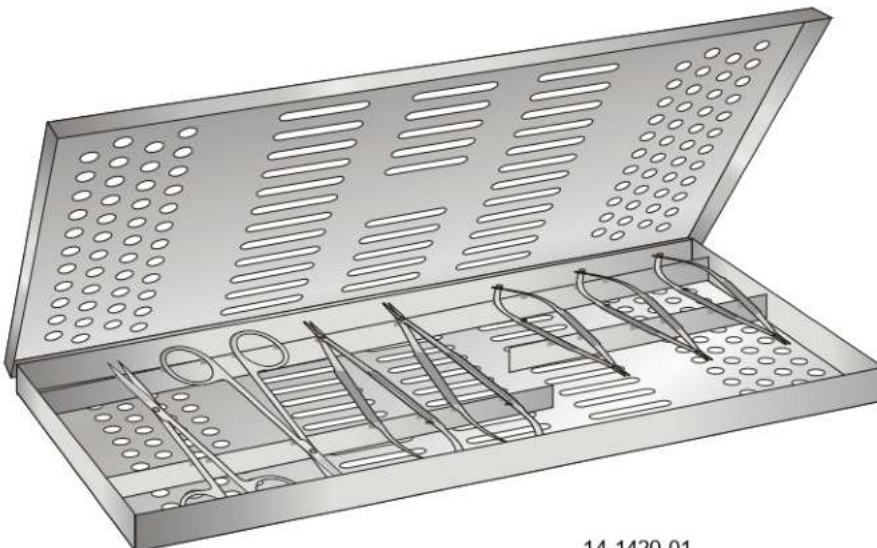
Set microchirurgia oftalmica



14-1410-01

14-1410
Consisting

- Micro pinzetta 1x2 denti cm. 9,5
- Micro pinzetta McPherson cm. 9,5
- Micro pinzetta cristallino cm. 11
- Micro pinzetta angolata cm. 11
- Micro pinzetta 1x2 denti cm. 9,5
- Micro pinzetta 1x2 denti cm. 9,5
- Micro pinzetta diritta cm. 9,5
- Micro pinzetta curva cm. 9,5
- Micro pinzetta Colibri cm. 9,5



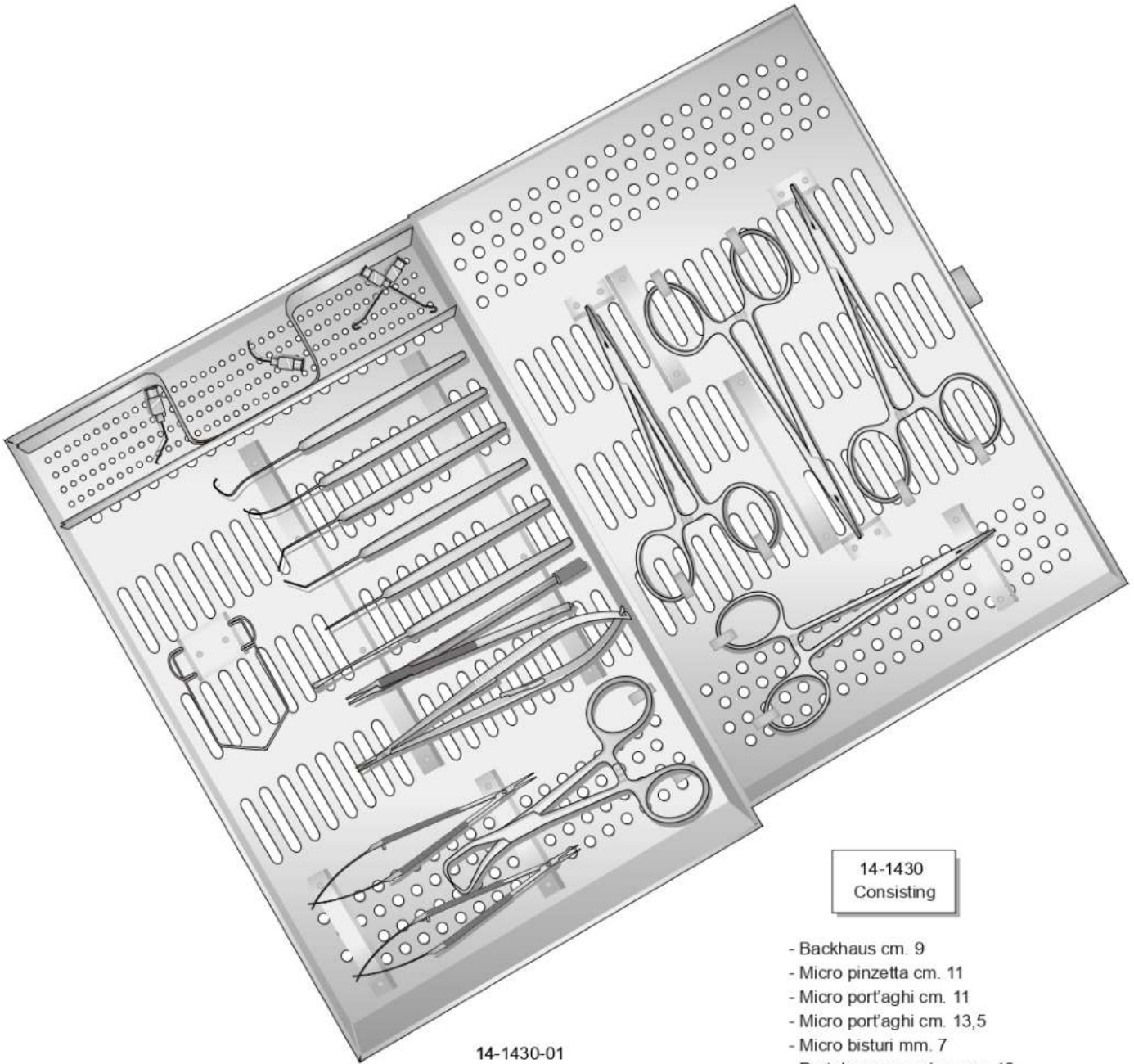
14-1420-01

14-1420
Consisting

- Micro forbice Troutmann dx. cm. 11
- Micro forbice Troutmann sx. cm. 11
- Micro forbice Vannas cm. 8,5
- Micro forbice Vannas cm. 8,5
- Micro forbice Vannas cm. 8,5
- Forbice Iris diritta cm. 11
- Forbice Iris curva cm. 11



Set microchirurgia oftalmica



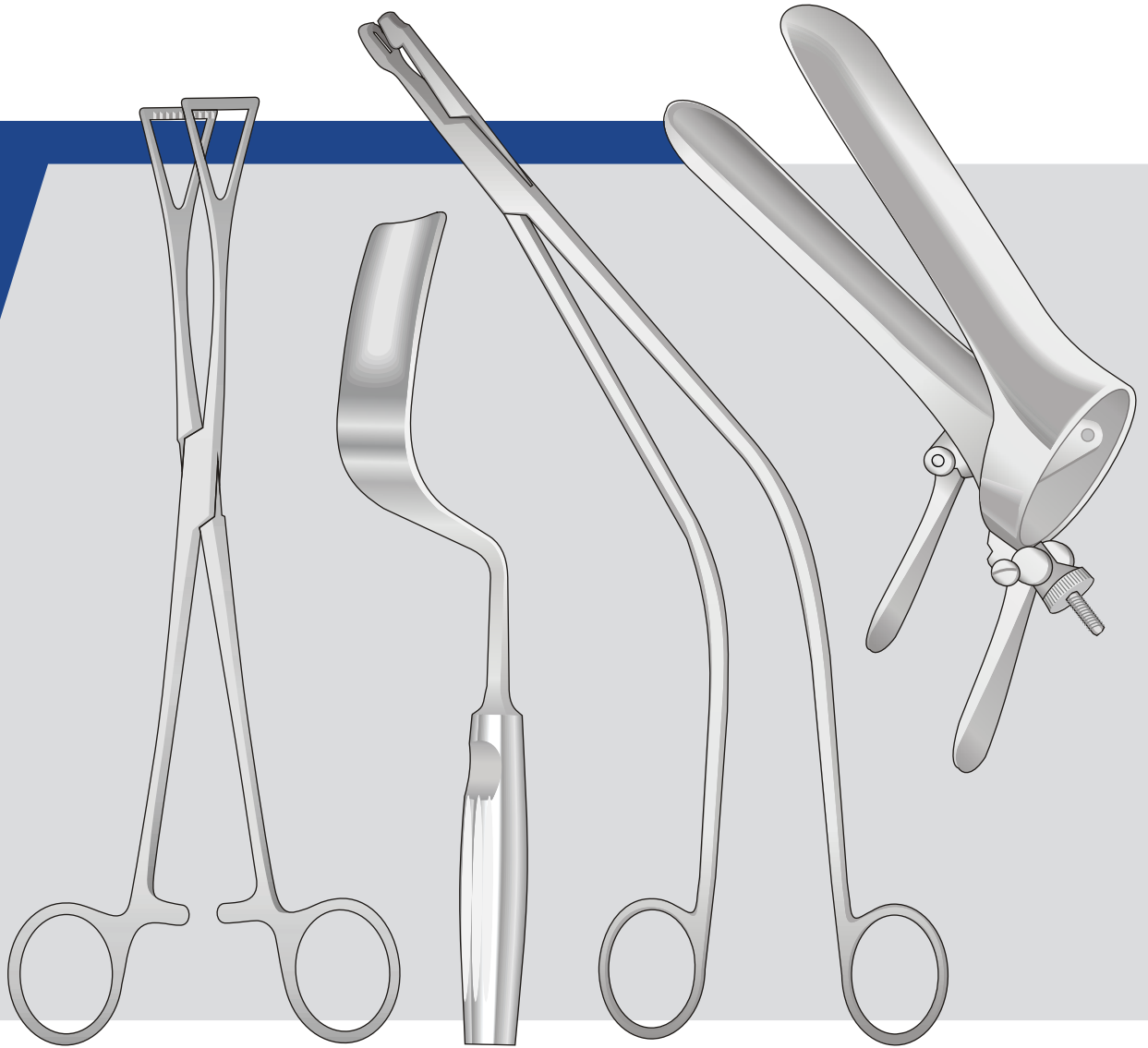
14-1430-01

14-1430
Consisting

- Backhaus cm. 9
- Micro pinzetta cm. 11
- Micro port'aghi cm. 11
- Micro port'aghi cm. 13,5
- Micro bisturi mm. 7
- Portalame per micro cm. 12
- Micro divaricatore Snellen cm. 12
- Uncino Arruga cm. 14
- Blefarostato Barraquer mm. 42x12
- Micro spatola mm. 0,2
- Micro spatola mm. 0,6
- Micro spatola mm. 1
- Ago lacrimale curvo mm. 30
- Ago lacrimale 15° Sx.
- Ago lacrimale 15° Dx.
- Ago lacrimale curvo mm. 35
- Halstead diritta cm. 12,5
- Pinza Anat. Diritta cm. 14



SAFE TOOL
MANUFACTURER & EXPORTER

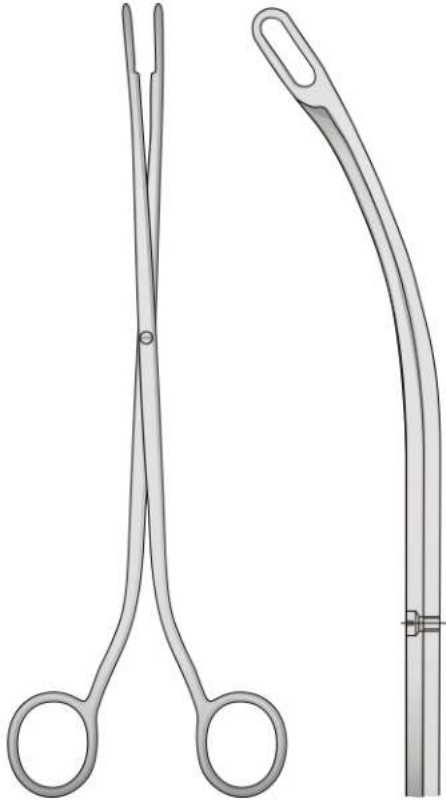


Gynecology | Urology Instruments



www.safetool.com.pk

***Surgical
Instruments***



DESJARDINS

ST-7001
225 mm

Fig. 1



ST-7001-1

Fig. 3



ST-7001-2

Fig. 2

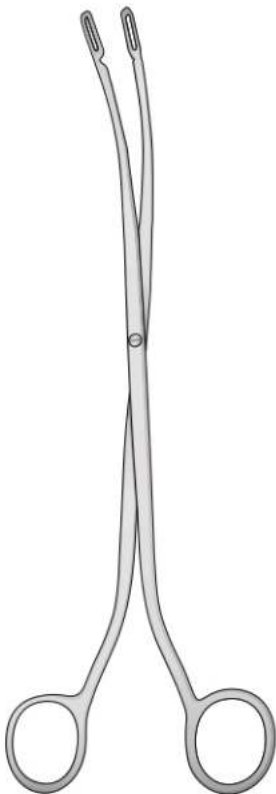


ST-7001-3

Fig. 4



ST-7001-4



RANDALL

ST-7002
225 mm

Fig. 1



ST-7002-1

Fig. 3



ST-7002-2

Fig. 2



ST-7002-3

Fig. 4



ST-7002-4



Per uomini
For men
Für Männer
Pour hommes
Para hombres

Charr.	
ST-7003-1	8
ST-7003-2	10
ST-7003-3	12
ST-7003-4	14
ST-7003-5	16
ST-7003-6	18
ST-7003-7	20

Ø 2,7 mm

Ø 3 mm

Ø 1,2 mm

Ø 3 mm

Per donne
For woman
Für Frauen
Pour femmes
Para mujeres

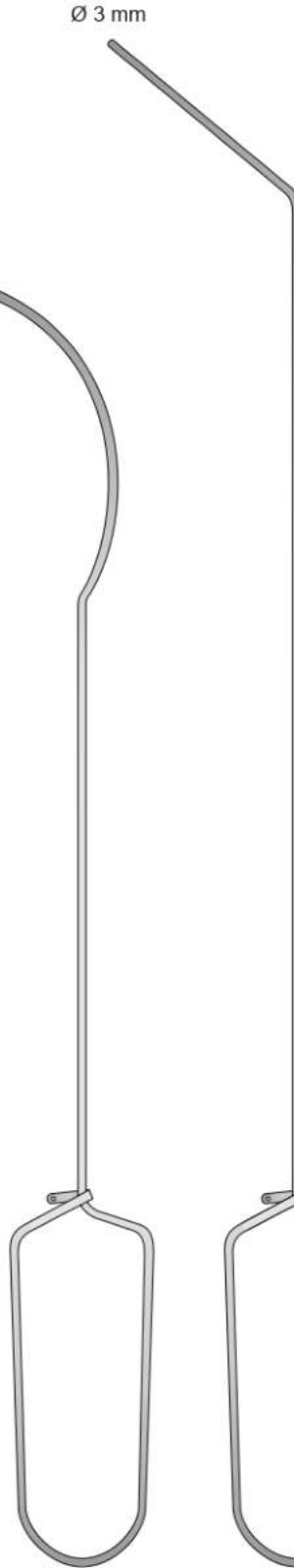
Charr.	
ST-7004-1	6
ST-7004-2	8
ST-7004-3	10
ST-7004-4	12
ST-7004-5	14
ST-7004-6	16
ST-7004-7	18



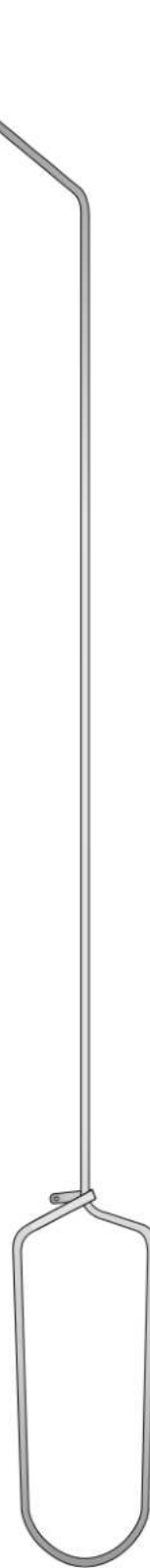
ST-7003
290 mm



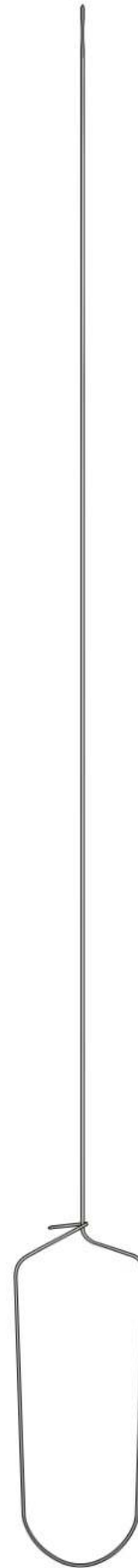
ST-7004
160 mm



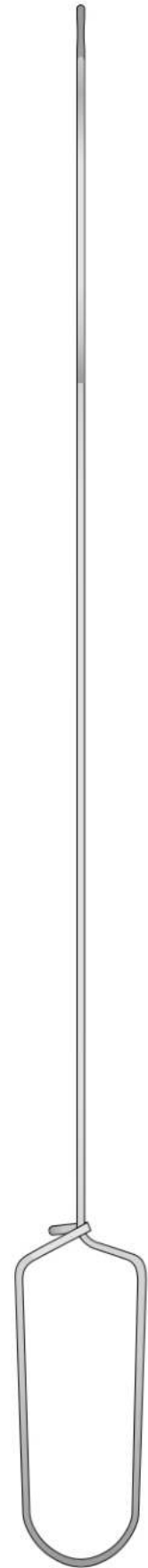
GUYON
ST-7005
365 mm



BENIQUE
ST-7006
410 mm



ST-7007
460 mm



ST-7008
460 mm

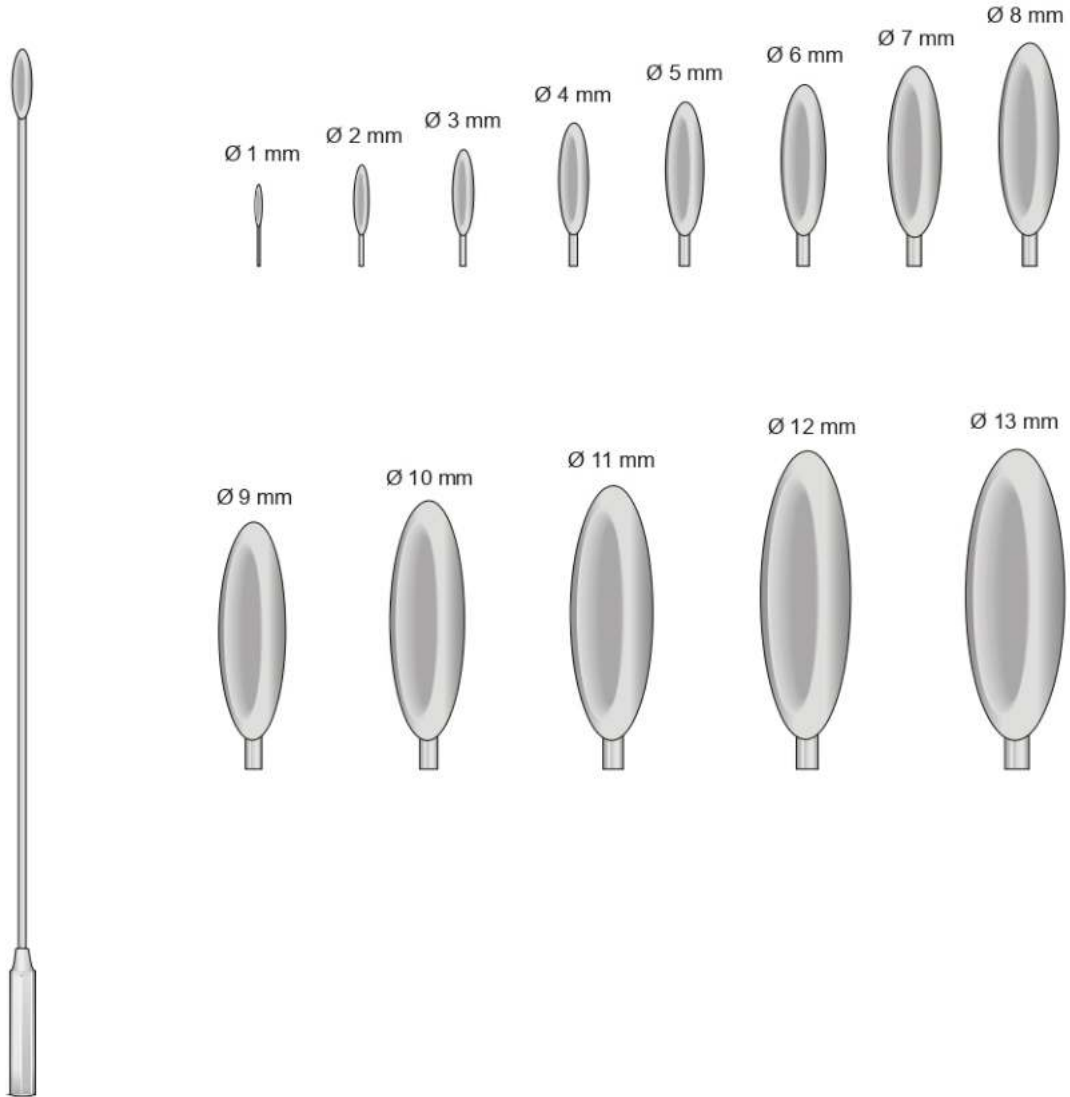


- ST-7009-1 - 190 mm - Ø 3 mm
- ST-7009-2 - 190 mm - Ø 4 mm
- ST-7009-3 - 190 mm - Ø 5 mm
- ST-7009-4 - 190 mm - Ø 6 mm
- ST-7009-5 - 190 mm - Ø 7 mm
- ST-7009-6 - 190 mm - Ø 8 mm
- ST-7009-7 - 190 mm - Ø 9 mm
- ST-7009-8 - 190 mm - Ø 10 mm
- ST-7009-9 - 190 mm - Ø 11 mm

- ST-7010-1 - 300 mm - Ø 1 mm
- ST-7010-2 - 300 mm - Ø 2 mm
- ST-7010-3 - 300 mm - Ø 3 mm
- ST-7010-4 - 300 mm - Ø 4 mm
- ST-7010-5 - 300 mm - Ø 5 mm
- ST-7010-6 - 300 mm - Ø 6 mm
- ST-7010-7 - 300 mm - Ø 7 mm
- ST-7010-8 - 300 mm - Ø 8 mm
- ST-7010-9 - 300 mm - Ø 9 mm
- ST-7010-10 - 300 mm - Ø 10 mm
- ST-7010-11 - 300 mm - Ø 11 mm
- ST-7010-12 - 300 mm - Ø 12 mm
- ST-7010-13 - 300 mm - Ø 13 mm

ST-7009
Set completo di 9 pezzi
con custodia

ST-7010
Set completo di
13 pezzi



BAKES
ST-7009



DITTEL
ST-7011
220 mm

	Charr.
ST-7011-1	8
ST-7011-2	9
ST-7011-3	10
ST-7011-4	11
ST-7011-5	12
ST-7011-6	14
ST-7011-7	16
ST-7011-8	18
ST-7011-9	20
ST-7011-10	22
ST-7011-11	24
ST-7011-12	25
ST-7011-13	26
ST-7011-14	27
ST-7011-15	28
ST-7011-16	29
ST-7011-17	30



DITTEL
ST-7012
345 mm

	Charr.
ST-7012-1	8
ST-7012-2	9
ST-7012-3	10
ST-7012-4	11
ST-7012-5	12
ST-7012-6	13
ST-7012-7	14
ST-7012-8	15
ST-7012-9	16
ST-7012-10	17
ST-7012-11	18
ST-7012-12	19
ST-7012-13	20
ST-7012-14	21
ST-7012-15	22
ST-7012-16	23
ST-7012-17	24
ST-7012-18	25
ST-7012-19	26
ST-7012-20	27
ST-7012-21	28
ST-7012-22	29
ST-7012-23	30



ST-7013-1 - Ø 10 mm  1/1

ST-7013-2 - Ø 9 mm  1/1

ST-7013-3 - Ø 8 mm  1/1

ST-7013-4 - Ø 7 mm  1/1

ST-7013-5 - Ø 6 mm  1/1

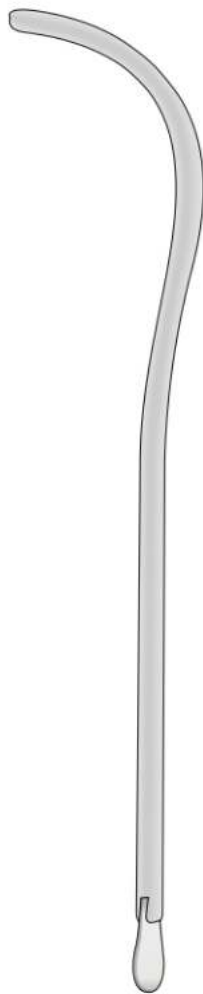
ST-7013-6 - Ø 5 mm  1/1

ST-7013-7 - Ø 4 mm  1/1

ST-7013-8 - Ø 3 mm  1/1

ST-7013
190 mm

Sonde per dotto biliare, Elastiche
Gall Stone Probes, Elastic
Gallensteinsonden, Federnd
Explorateurs pour calculs biliaries, Élastiques
Exploradores para cálculos biliaries, Elásticos



GUYON
ST-7014
255 mm

	Ben.	Charr.
ST-7014-1	24	12
ST-7014-2	26	13
ST-7014-3	28	14
ST-7014-4	30	15
ST-7014-5	32	16
ST-7014-6	34	17
ST-7014-7	36	18
ST-7014-8	38	19
ST-7014-9	40	20
ST-7014-10	42	21
ST-7014-11	44	22
ST-7014-12	46	23
ST-7014-13	48	24
ST-7014-14	50	25
ST-7014-15	52	26
ST-7014-16	54	27
ST-7014-17	56	28
ST-7014-18	58	29
ST-7014-19	60	30



DESJARDINS
ST-7015
280 mm

Ø 4,3 mm



1/1

ST-7015-1

Ø 6,0 mm



1/1

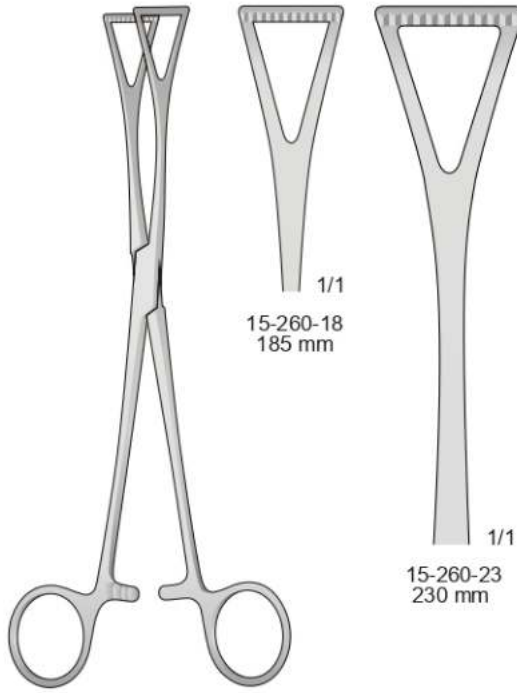
ST-7015-2

Ø 7,0 mm

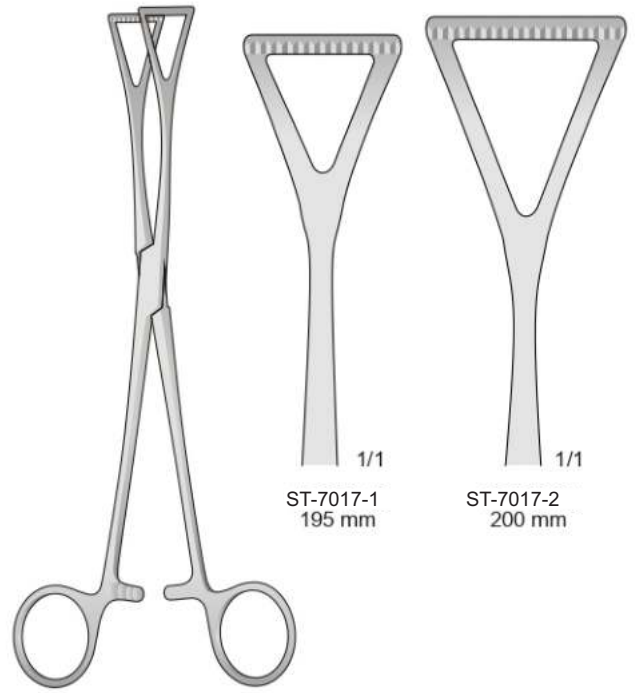


1/1

ST-7015-3

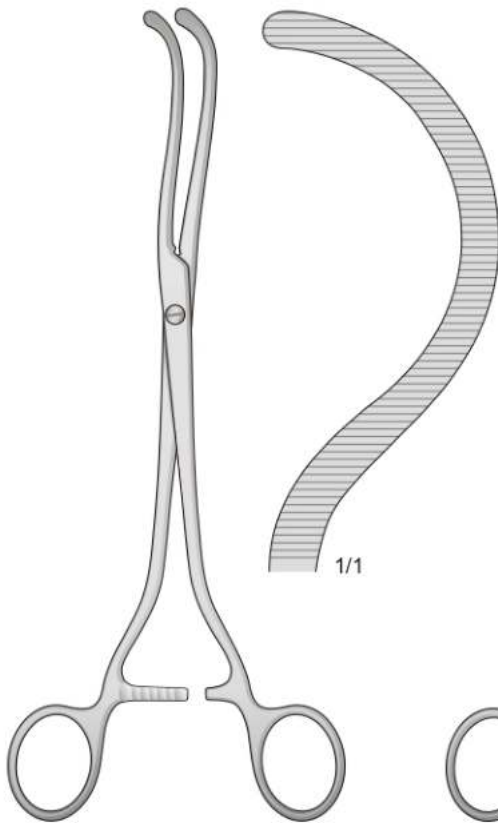


DUVAL
ST-7016

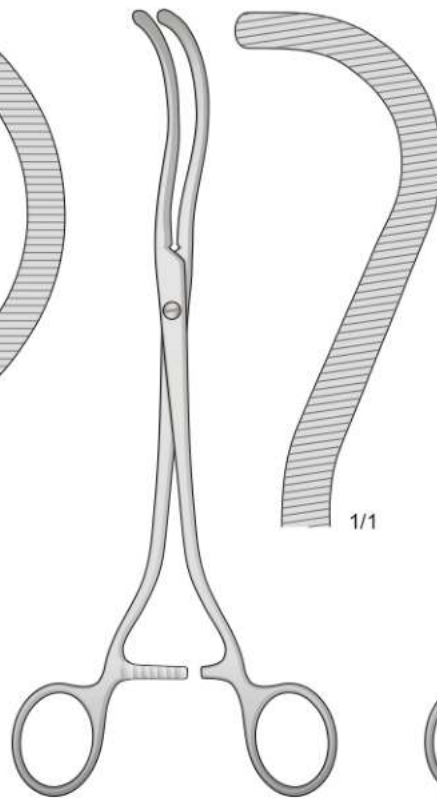


DUVAL-COLLIN
ST-7017

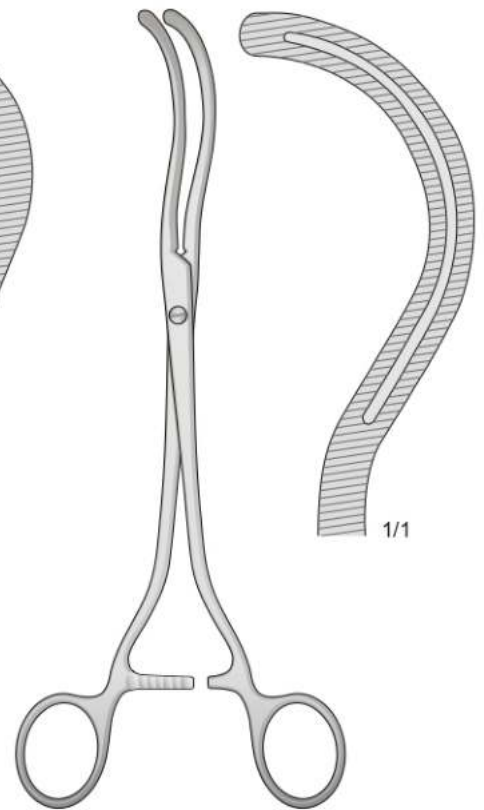
Pinze per peduncoli renali - Kidney pedicle clamp forceps - Nierenstielklemmen
Pincas-clamps pour pédicules rénaux - Pinzas-clamps para pedúnculos renales



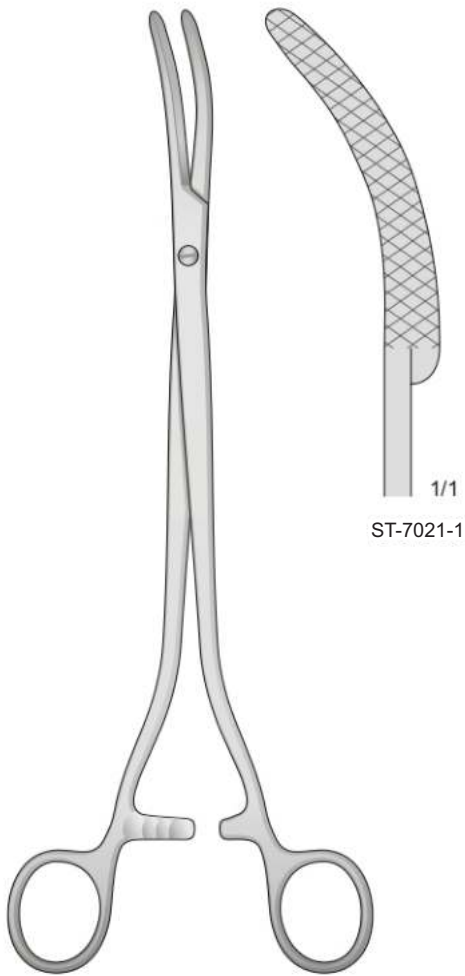
BRAUN
ST-7018
245 mm



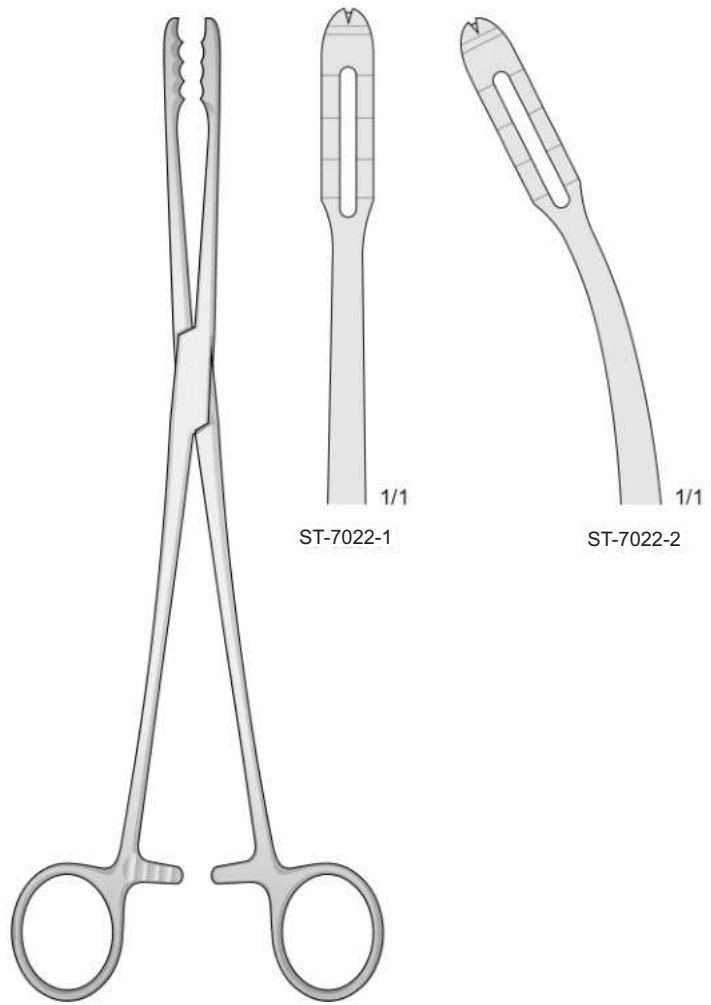
GUYON
15-290-23
235 mm



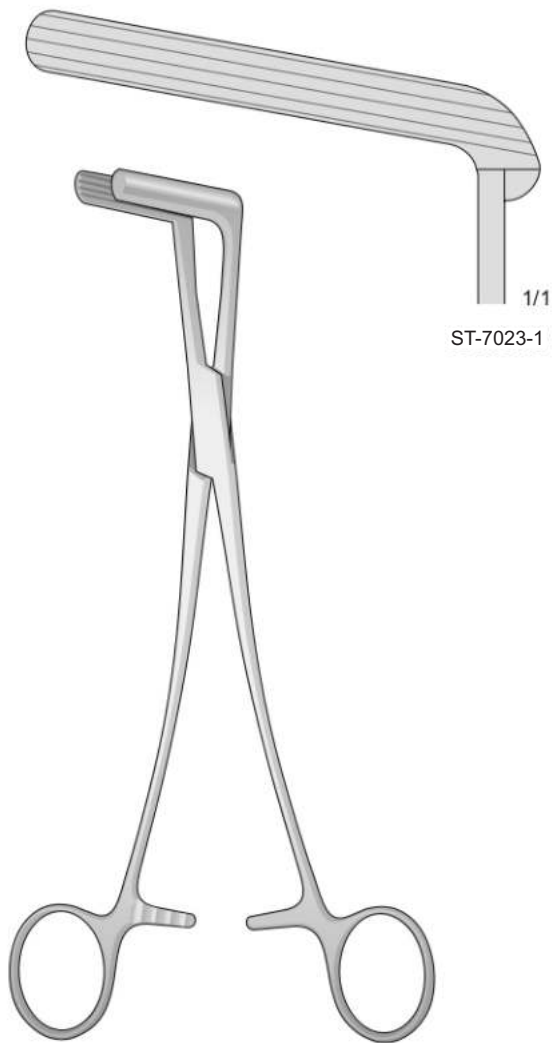
STILLE
ST-7020
240 mm



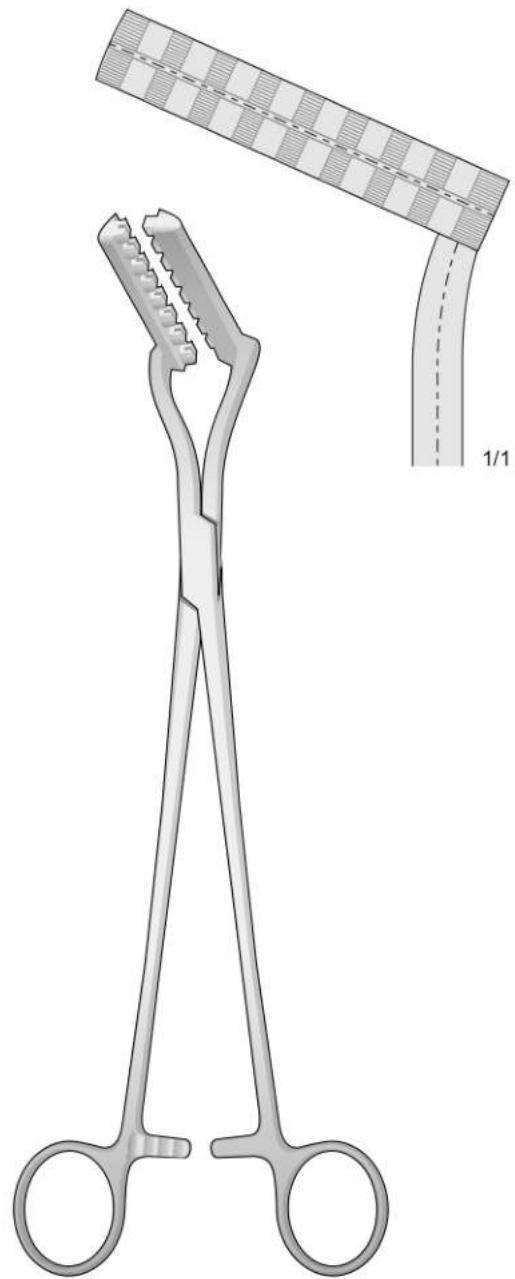
WERTHEIM
ST-7021
260 mm



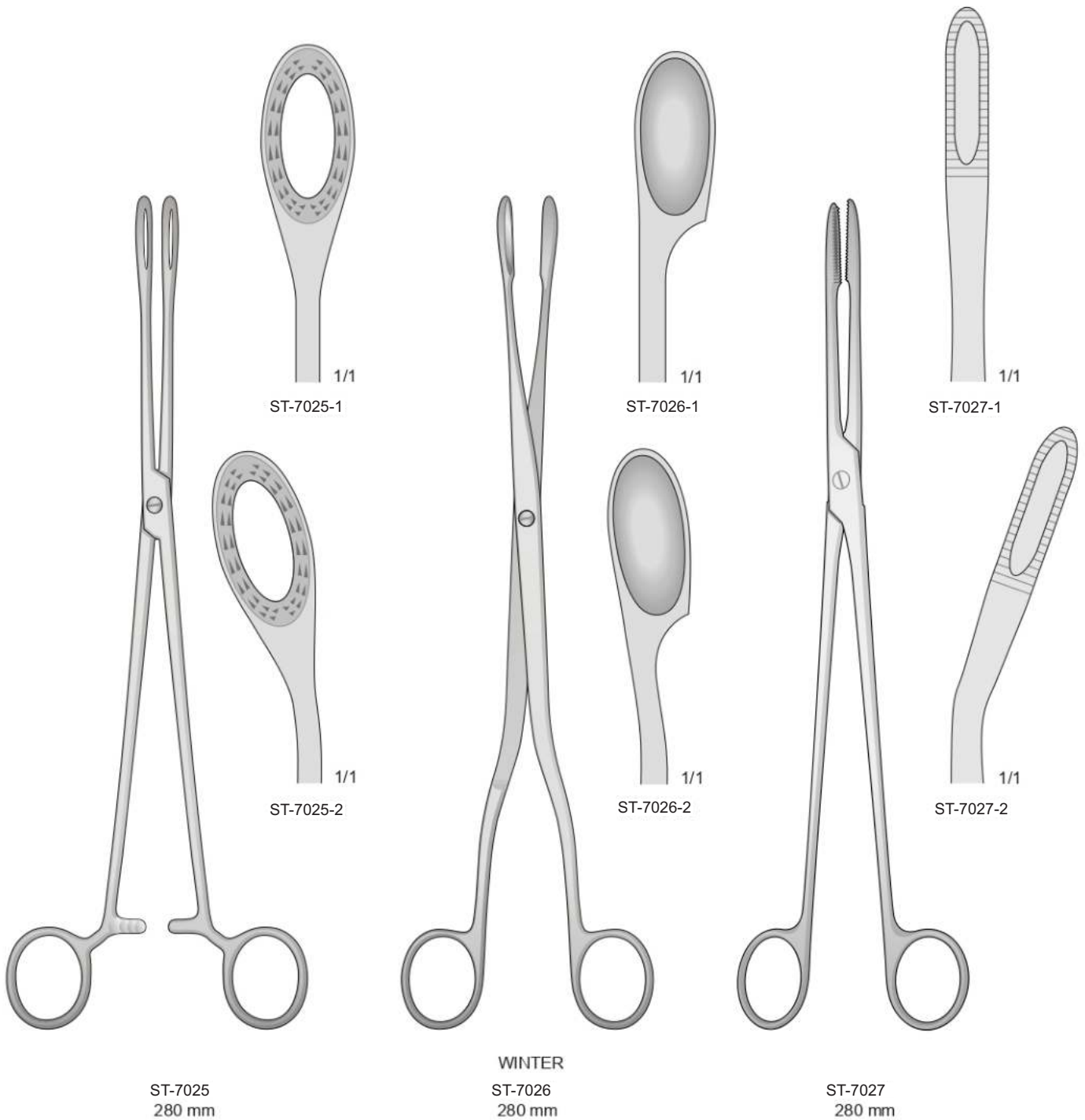
ST-7022
265 mm

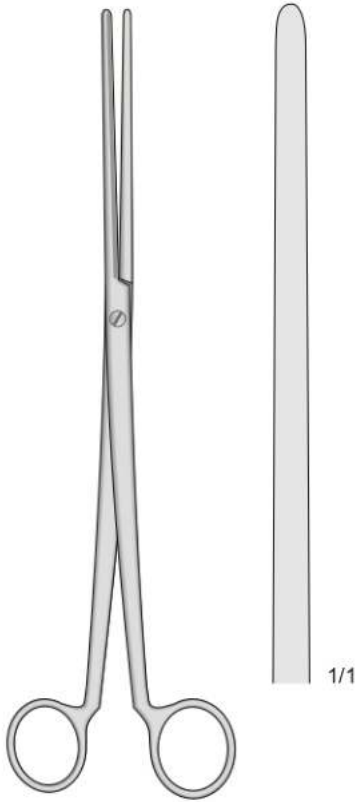


WERTHEIM
ST-7023
235 mm

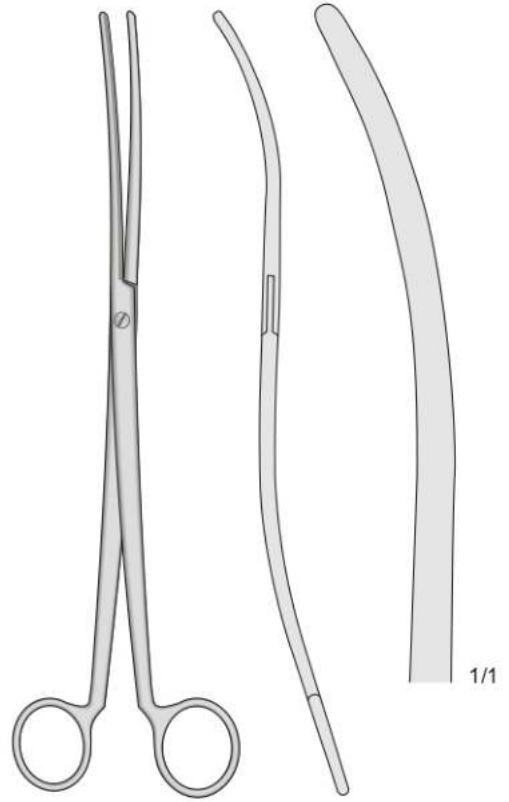


ST-7024
280 mm

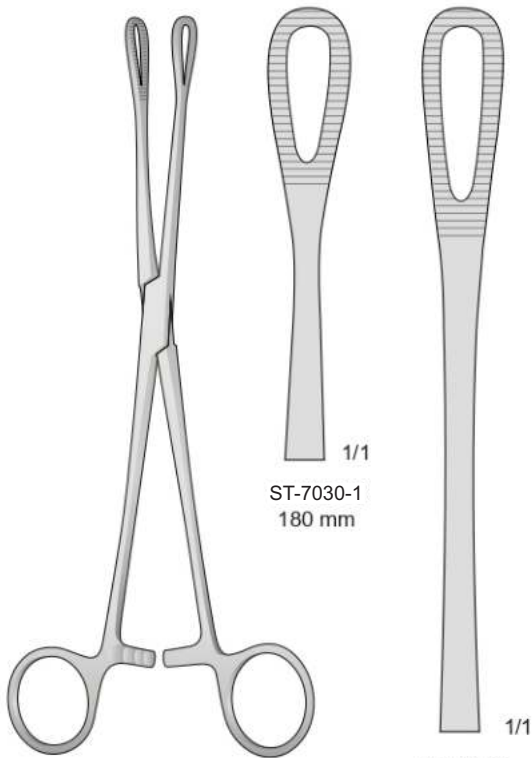




COLLIN
ST-7028
260 mm



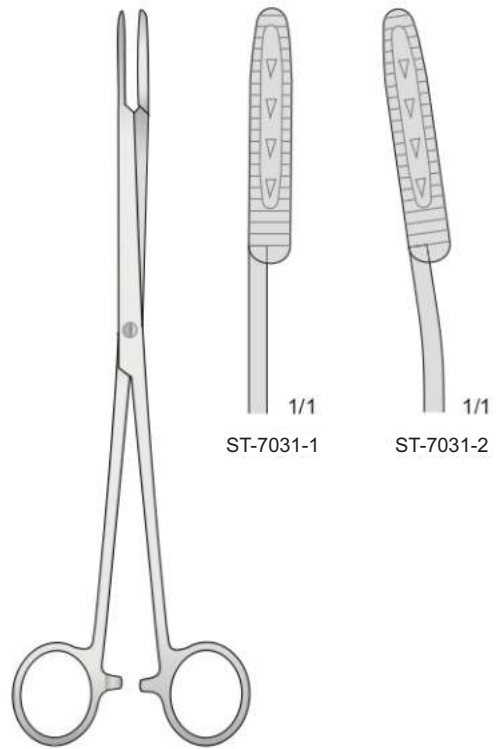
COLLIN
ST-7029
260 mm



RAMPLEY
ST-7030

ST-7030-1
180 mm

ST-7030-2
245 mm



MAIER
ST-7031
245 mm

ST-7031-1

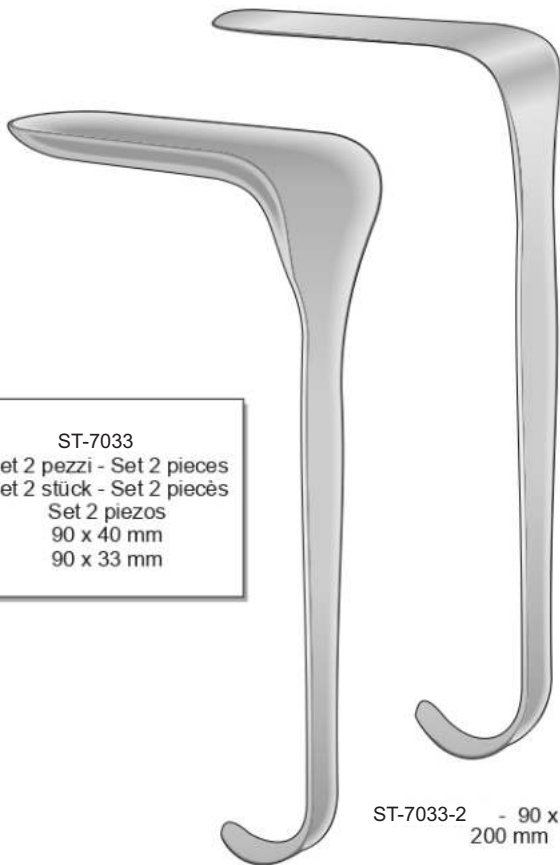
ST-7031-2



KALLMORGEN
ST-7032-1 - 70 x 40 mm
170 mm

ST-7032-2 - 70 x 33 mm
170 mm

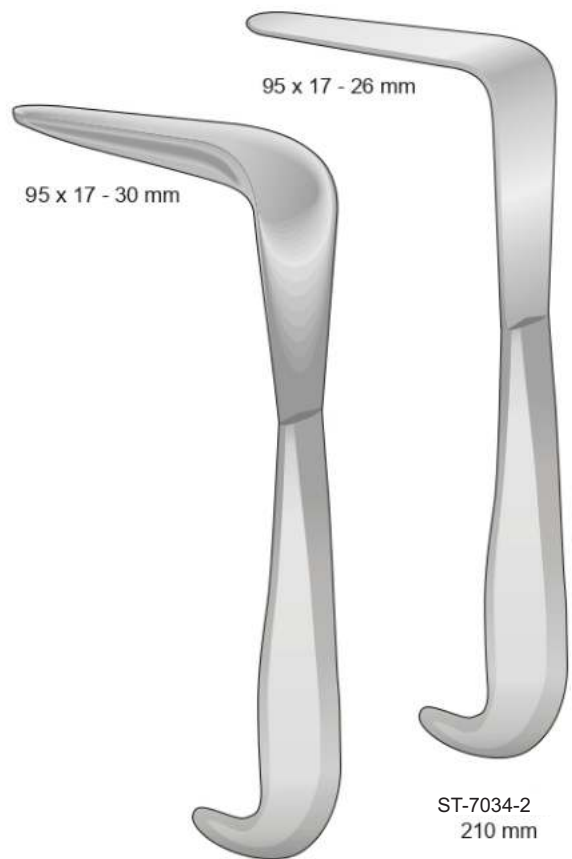
ST-7032
Set 2 pezzi - Set 2 pieces
Set 2 stück - Set 2 pièces
Set 2 piezas
70 x 40 mm
70 x 33 mm



KALLMORGEN
ST-7033-1 - 90 x 40 mm
200 mm

ST-7033-2 - 90 x 33 mm
200 mm

ST-7033
Set 2 pezzi - Set 2 pieces
Set 2 stück - Set 2 pièces
Set 2 piezas
90 x 40 mm
90 x 33 mm

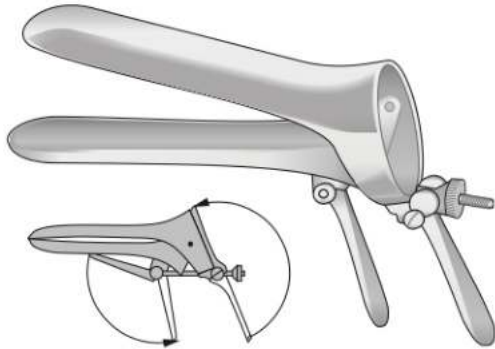


MATHIEU
ST-7034-1
210 mm

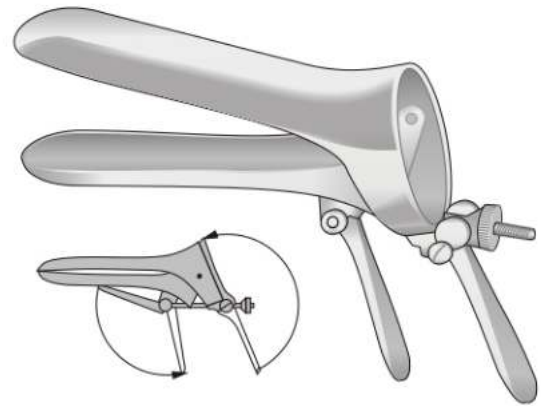
ST-7034-2
210 mm

95 x 17 - 30 mm

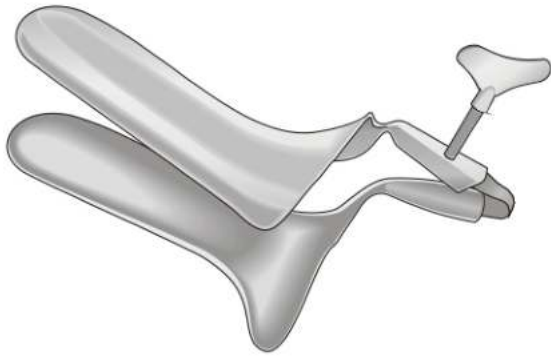
95 x 17 - 26 mm



CUSCO
ST-7035-1 Fig. 0 77x17 mm
ST-7035-2 Fig. 1 75x33 mm
ST-7035-3 Fig. 2 86x36 mm
ST-7035-4 Fig. 3 97x36 mm



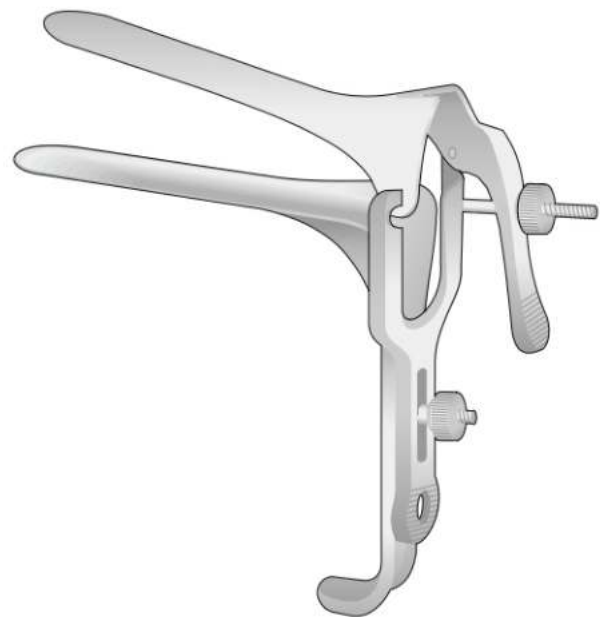
**CUSCO
SCHWEIZER MODELL**
ST-7036-1 Fig.1 90x23 mm
ST-7036-2 Fig.2 100x24 mm
ST-7036-3 Fig.3 105x27 mm



COLLIN-STANDARD
ST-7037-1 Fig. 1 90x29 mm
ST-7037-2 Fig. 2 95x35 mm
ST-7037-3 Fig. 3 110x40 mm



GRAVE
ST-7038-1 75x20 mm
ST-7038-2 95x30 mm
ST-7038-3 105x33 mm



PEDERSON
ST-7039-1 700x22 mm
ST-7039-2 720x25 mm



Speculum
Spekula
Specula
Spéculums
Espéculos



KRISTELLER
Fig. 1 ST-7040-1 - 70 x 27 mm
Fig. 2 ST-7040-2 - 75 x 30 mm
Fig. 3 ST-7040-3 - 90 x 36 mm

Valva
Halter
Retractors
Valves
Valvas



KRISTELLER
Fig. 1 ST-7040-4 - 75 x 23 mm
Fig. 2 ST-7040-5 - 80 x 26 mm
Fig. 3 ST-7040-6 - 95 x 32 mm

Speculum + Valva
Specula + Retractor
Spekula + Halter
Spéculum + Valve
Espéculo + Valva

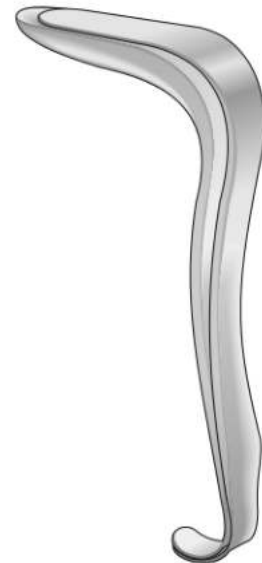


Fig. 1 ST-7041-1
Fig. 2 ST-7041-2
Fig. 3 ST-7041-3

Speculum
Spekula
Specula
Spéculums
Espéculos



KRISTELLER
Fig. 00 ST-7043-1 - 110 x 18 mm
Fig. 0 ST-7043-2 - 110 x 21 mm
Fig. 1 ST-7043-3 - 110 x 27 mm
Fig. 2 ST-7043-4 - 110 x 30 mm
Fig. 3 ST-7043-5 - 110 x 36 mm

Valva
Halter
Retractors
Valves
Valvas



KRISTELLER
Fig. 00 ST-7043-6 - 115 x 14 mm
Fig. 0 ST-7043-7 - 115 x 17 mm
Fig. 1 ST-7043-8 - 115 x 23 mm
Fig. 2 ST-7043-9 - 115 x 26 mm
Fig. 3 ST-7043-10 - 115 x 32 mm

Speculum + Valva
Specula + Retractor
Spekula + Halter
Spéculum + Valve
Espéculo + Valva

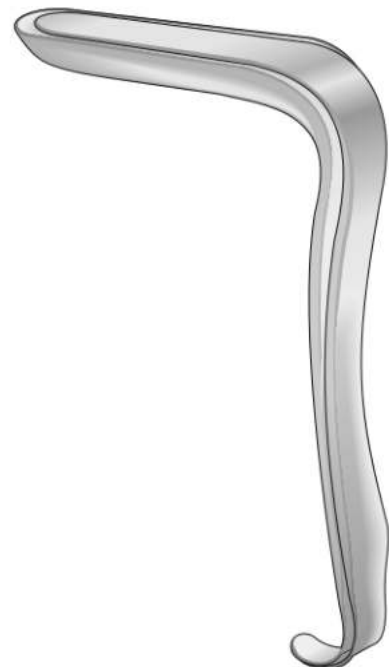
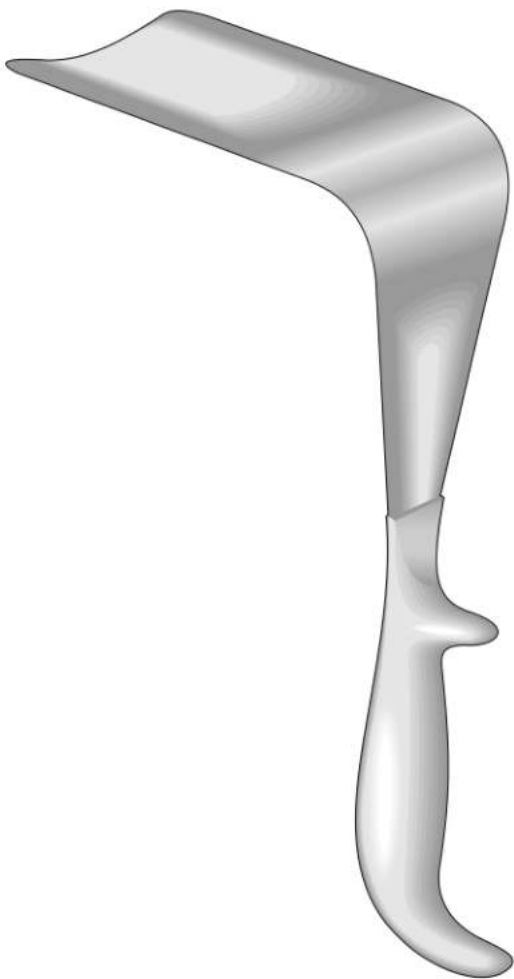


Fig. 00 ST-7044-1
Fig. 0 ST-7044-2
Fig. 1 ST-7044-3
Fig. 2 ST-7044-4
Fig. 3 ST-7044-5



DOYEN
ST-7045
240 mm

- Fig. 1 ST-7045-1 - 60 x 35 mm
- Fig. 2 ST-7045-2 - 90 x 35 mm
- Fig. 3 ST-7045-3 - 120 x 35 mm

- Fig. 1 ST-7045-4 - 60 x 45 mm
- Fig. 2 ST-7045-5 - 90 x 45 mm
- Fig. 3 ST-7045-6 - 120 x 45 mm
- Fig. 4 ST-7045-7 - 160 x 45 mm

- Fig. 1 ST-7045-8 - 60 x 60 mm
- Fig. 2 ST-7045-9 - 90 x 60 mm
- Fig. 3 ST-7045-10 - 120 x 60 mm
- Fig. 4 ST-7045-11 - 160 x 60 mm



LANDAU
ST-7046
290 mm

- ST-7046-1 - 100 x 28 mm
- ST-7046-2 - 100 x 38 mm



BREISKY

- ST-7047-1 - 100 x 20 mm
 - ST-7047-2 - 100 x 25 mm
 - ST-7047-3 - 100 x 30 mm
 - ST-7047-4 - 100 x 35 mm
 - ST-7047-5 - 100 x 40 mm
- 290 mm

BREISKY

- ST-7048-1 - 130 x 20 mm
 - ST-7048-2 - 130 x 25 mm
 - ST-7048-3 - 130 x 30 mm
 - ST-7048-4 - 130 x 35 mm
 - ST-7048-5 - 130 x 40 mm
- 320 mm

BREISKY

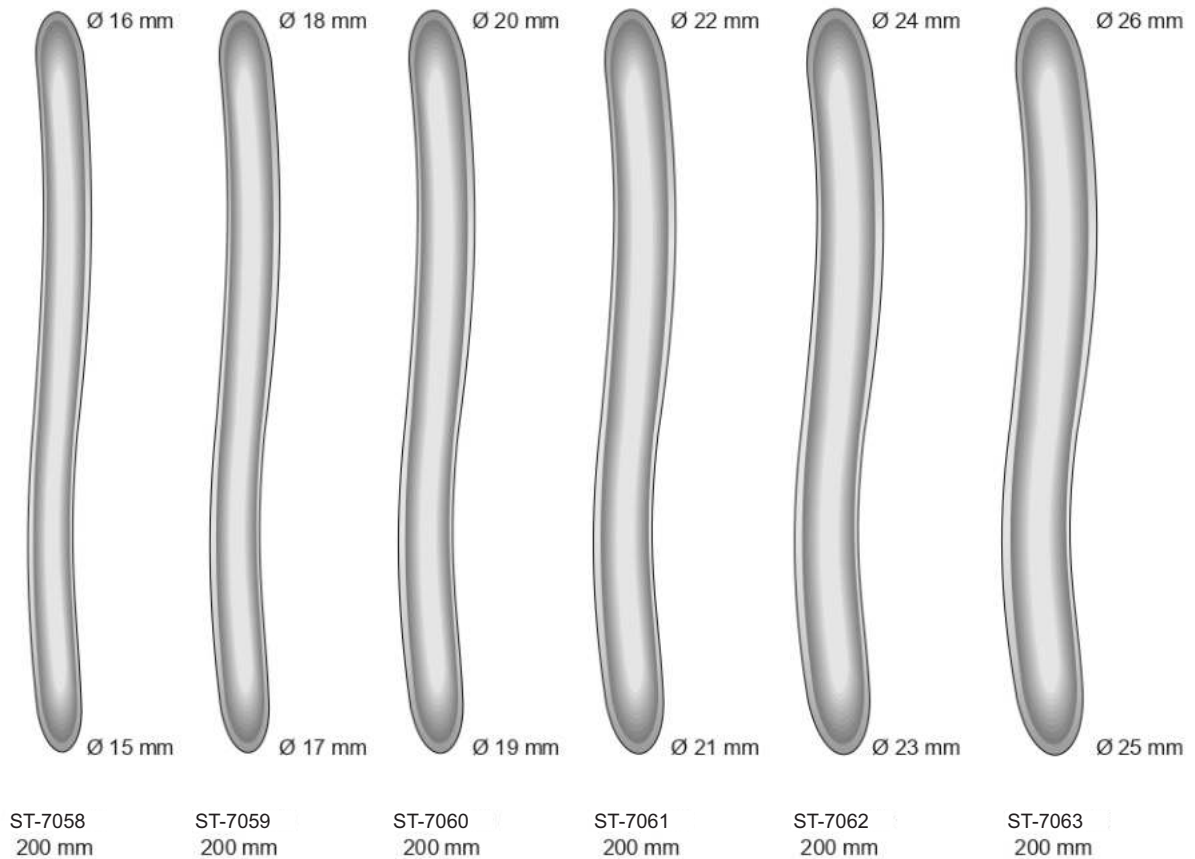
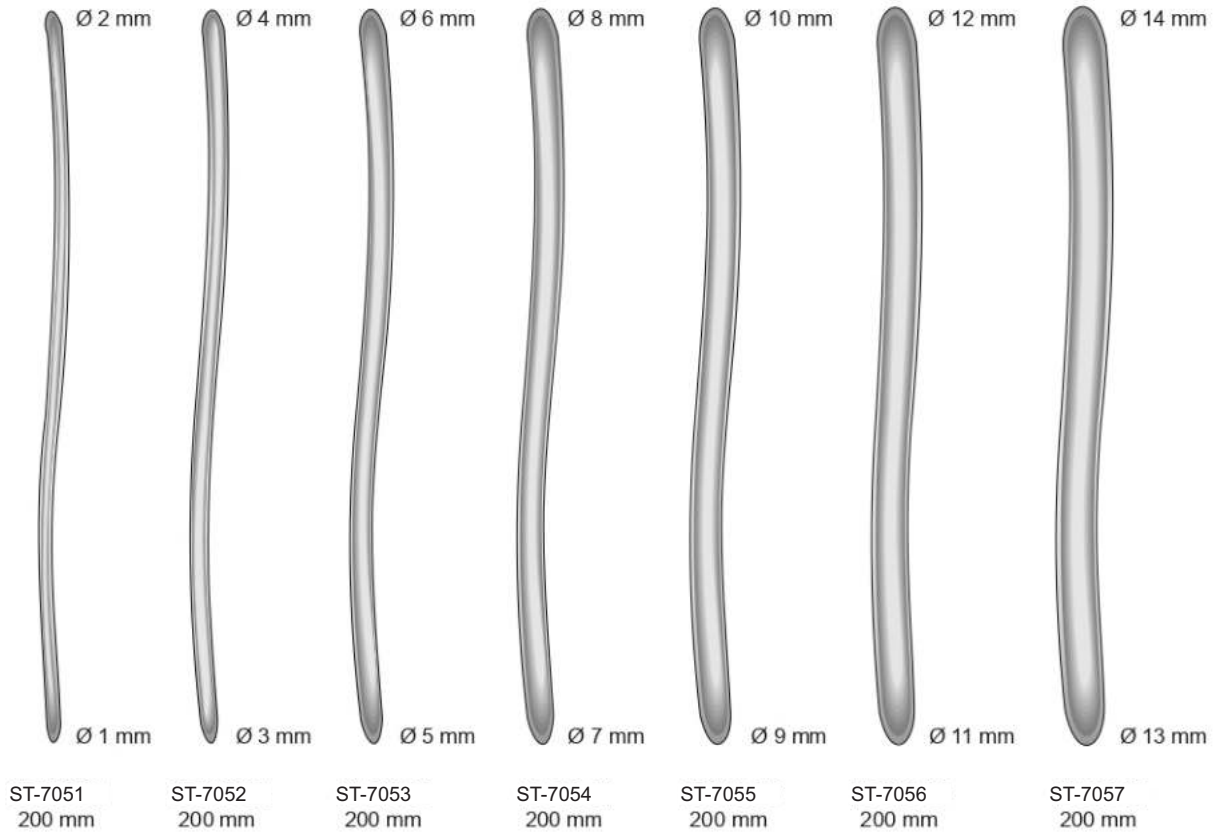
- ST-7049 - 160 x 40 mm
- 350 mm

BREISKY

- ST-7050 - 180 x 40 mm
- 370 mm



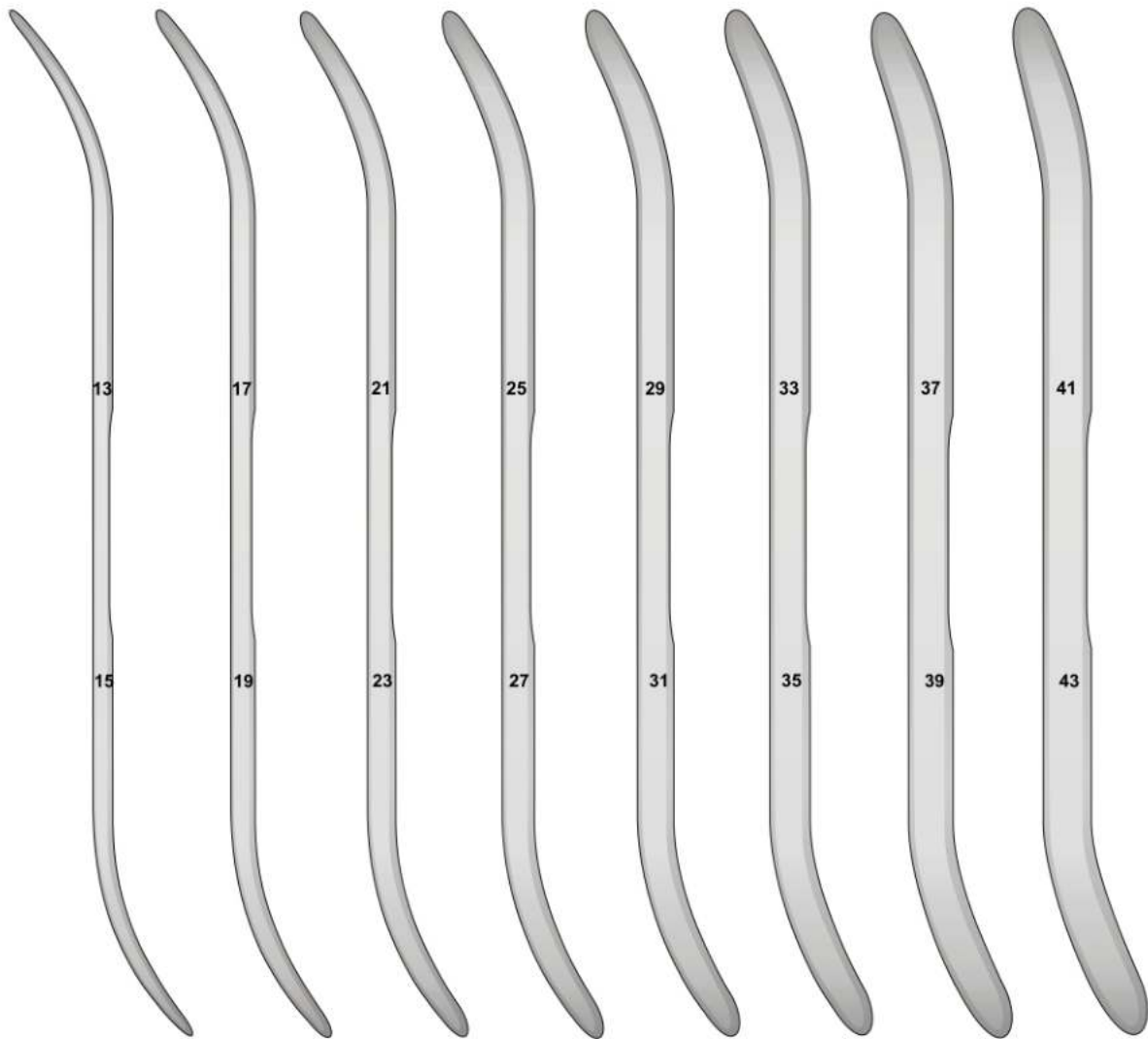
Hegar Dilatatori - Hegar Dilatators - Hegar Dilatatore - Hegar Dilateur - Hegar Dilatadores



Set completo dilatatori 8 pezzi
 Set complete with 8 pieces
 Satz-Dilatator, komplett, 8 Stück
 Jeu complet avec 8 pieces
 Juego completo con 8 piezas

Pratt Dilatatori
 Pratt Dilatators
 Pratt Dilatatoren
 Pratt Dilatateur
 Pratt Dilatadores

La misura è in French
 Breite in French



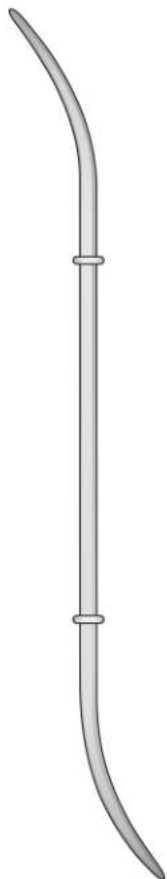
ST-7064	ST-7065	ST-7066	ST-7067	ST-7068	ST-7069	ST-7070	ST-7071
260 mm	260 mm	260 mm	260 mm	260 mm	260 mm	260 mm	260 mm



ST-7072 -01	1 mm	ST-7072 -14	14 mm	ST-7072 -29	1½ mm	ST-7072 -40	14½ mm
ST-7072 -02	2 mm	ST-7072 -15	15 mm	ST-7072 -30	2½ mm	ST-7072 -41	15½ mm
ST-7072 -03	3 mm	ST-7072 -16	16 mm	ST-7072 -31	3½ mm	ST-7072 -42	16½ mm
ST-7072 -04	4 mm	ST-7072 -17	17 mm	ST-7072 -32	4½ mm	ST-7072 -43	17½ mm
ST-7072 -05	5 mm	ST-7072 -18	18 mm	ST-7072 -33	5½ mm		
ST-7072 -06	6 mm	ST-7072 -19	19 mm	ST-7072 -34	6½ mm		
ST-7072 -07	7 mm	ST-7072 -20	20 mm	ST-7072 -35	7½ mm		
ST-7072 -08	8 mm	ST-7072 -21	21 mm	ST-7072 -36	8½ mm		
ST-7072 -09	9 mm	ST-7072 -22	22 mm	ST-7072 -37	9½ mm		
ST-7072 -10	10 mm	ST-7072 -23	23 mm	ST-7072 -38	10½ mm		
ST-7072 -11	11 mm	ST-7072 -24	24 mm	ST-7072 -39	11½ mm		
ST-7072 -12	12 mm	ST-7072 -25	25 mm		12½ mm		
ST-7072 -13	13 mm	ST-7072 -26	26 mm		13½ mm		

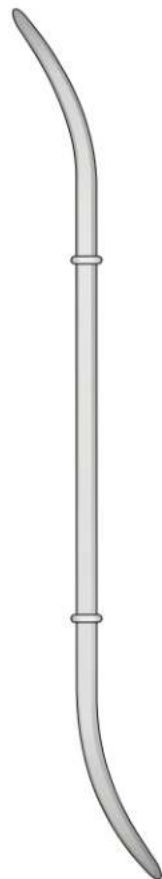
HEGAR
ST-7072
185 mm

Fig. 9/10
Ø 4,5/5,0 mm



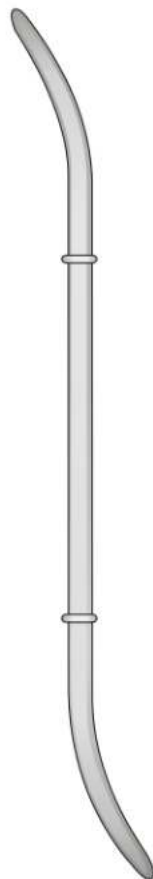
HANK
ST-7073-1
260 mm

Fig. 11/12
Ø 5,5/6,0 mm



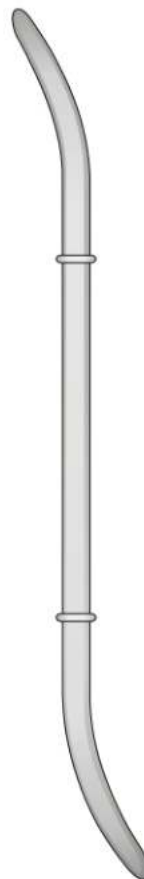
HANK
ST-7073-2
260 mm

Fig. 13/14
Ø 6,5/7,0 mm



HANK
ST-7073-3
260 mm

Fig. 15/16
Ø 7,5/8,0 mm



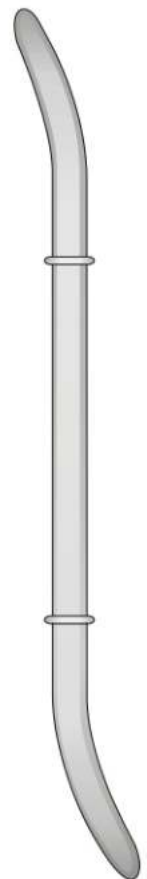
HANK
ST-7073-4
260 mm

Fig. 17/18
Ø 8,5/9,0 mm



HANK
ST-7073-5
260 mm

Fig. 19/20
Ø 9,5/10 mm



HANK
ST-7073-6
260 mm

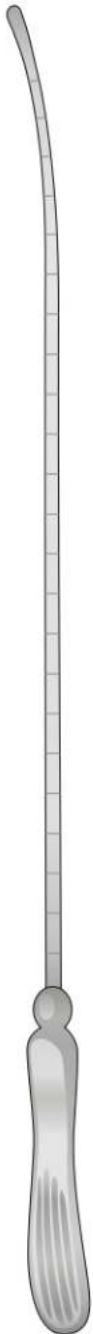
Graduati in centimetri
Graduated in centimeters
Zentimetereinteilung
Gradué en centimètres
Graduado en centímetros

Malleabile
Malleable
Biagsam
Malléables
Maleables

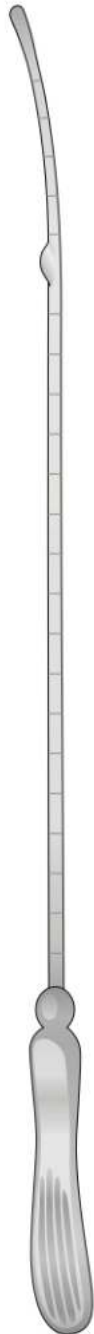
Malleabile
Malleable
Biagsam
Malléables
Maleables

Rigido
Rigid
Fest
Rigides
Rigidos

Malleabile
Malleable
Biagsam
Malléables
Maleables



SIMS
ST-7074
320 mm



SIMPSON
ST-7075 Ø 3mm
320 mm



SIMS
ST-7076
320 mm



ST-7076-1
Ø 3 mm

ST-7076-2
Ø 4 mm

VALLEIX
ST-7077 Ø 4mm
265 mm

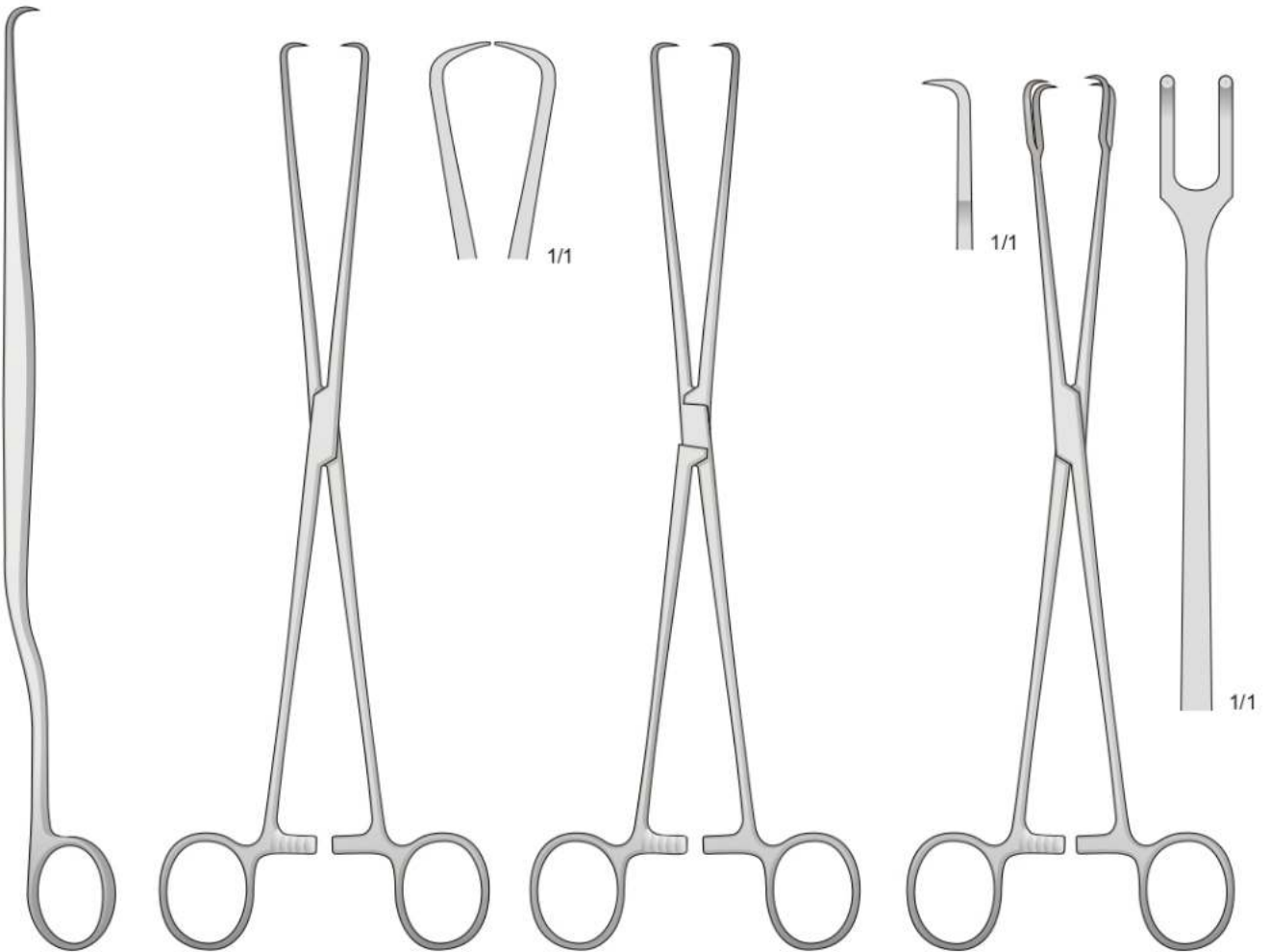


MARTIN
ST-7078 Ø 3mm
300 mm



MAYO
ST-7079 Ø 5mm
330 mm

Amniotomo per la
vescica amniotica
Amniotome for the
amniotic bladder
Amniotom für die
Amnionblase
Amniotome pour la
vésicule amniotique
Amniotomo para la
vesícula amniótica

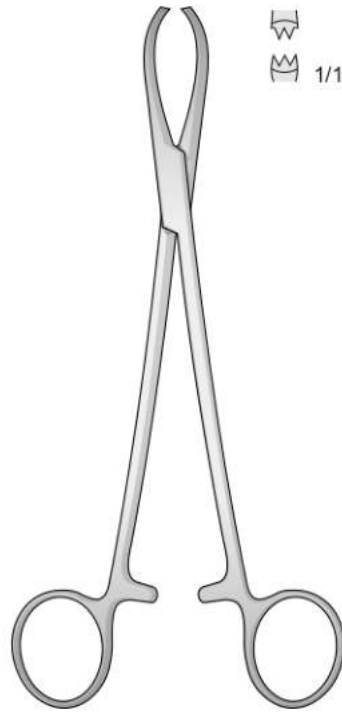


BEACHAM
ST-7080
260 mm

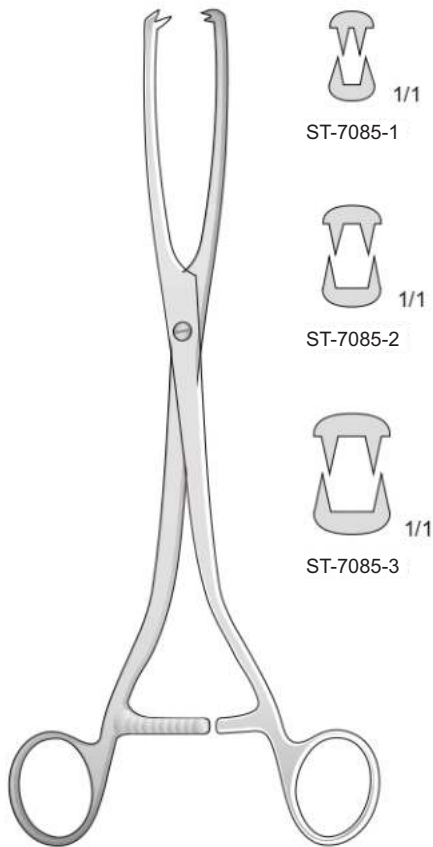
BRAUN
ST-7081
250 mm

POZZI
ST-7082
250 mm

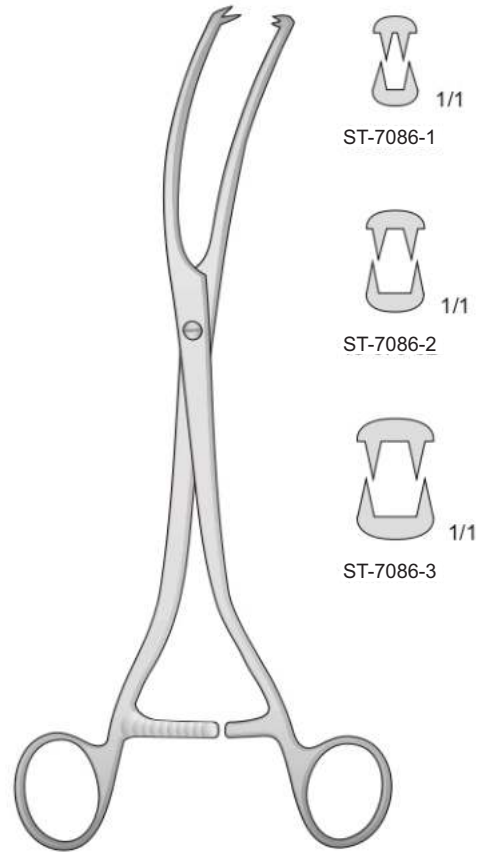
SCHROEDER
ST-7083
240 mm



LITTLEWOOD
ST-7084
185 mm



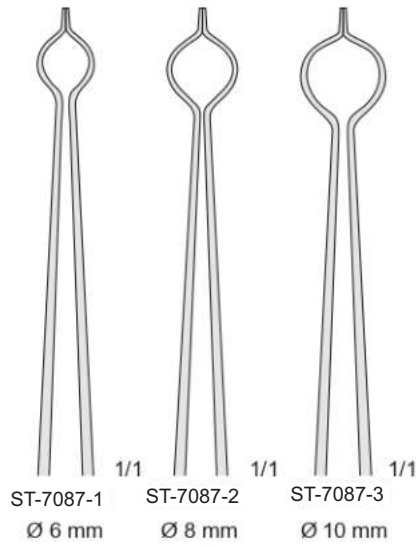
MUSEUX
ST-7085
240 mm



MUSEUX
ST-7086
240 mm



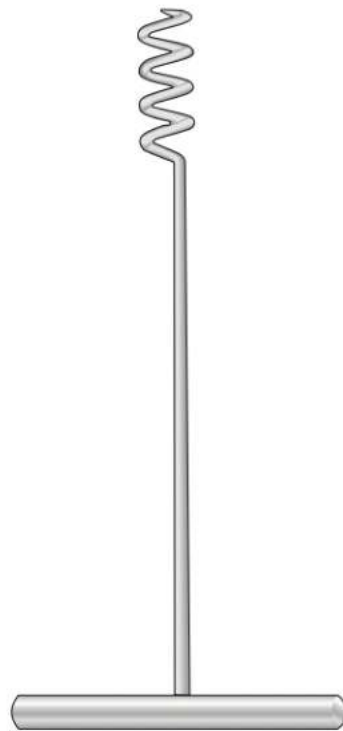
Pinzette per tube



NEUBÜSER
ST-7087
200 mm

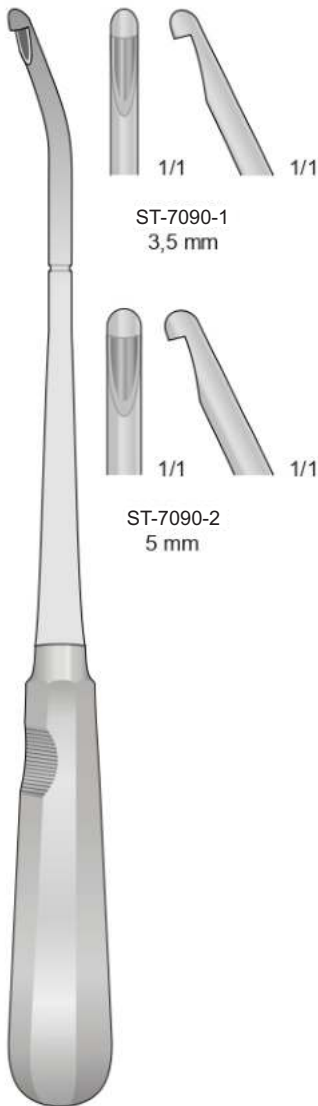


DOYEN
ST-7088
150 mm

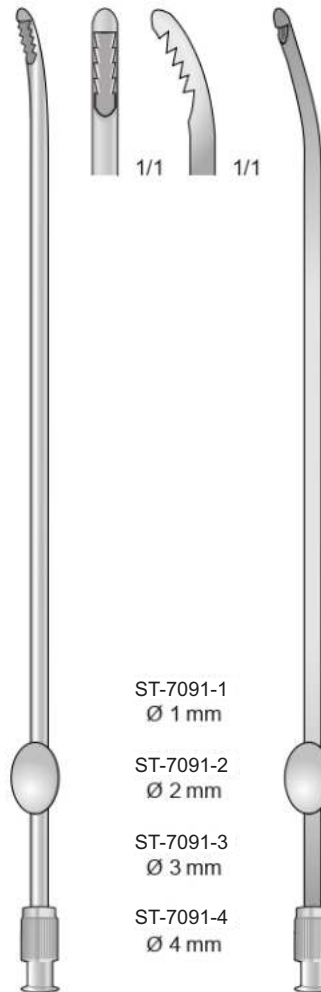


DOYEN
ST-7089
170 mm

Curette per biopsia endouterina
Endometrial Biopsy curette
Endometrium-Strichkurette
Curette pour biopsie intra-utérines
Cureta para biopsia endo-uterina



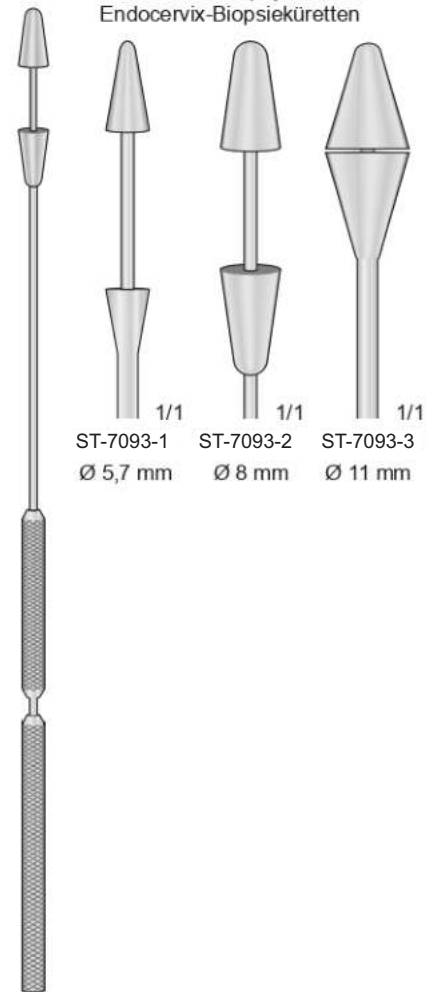
MÜNCHEN
ST-7090
270 mm



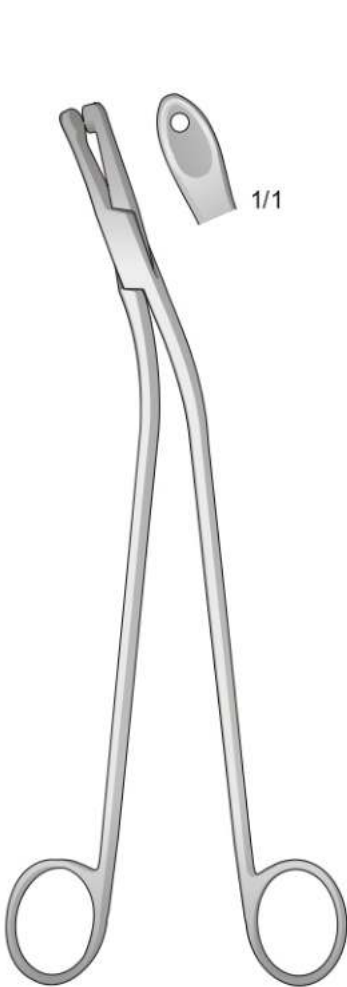
NOVAK
ST-7091
230 mm

RANDALL
ST-7092
230 mm

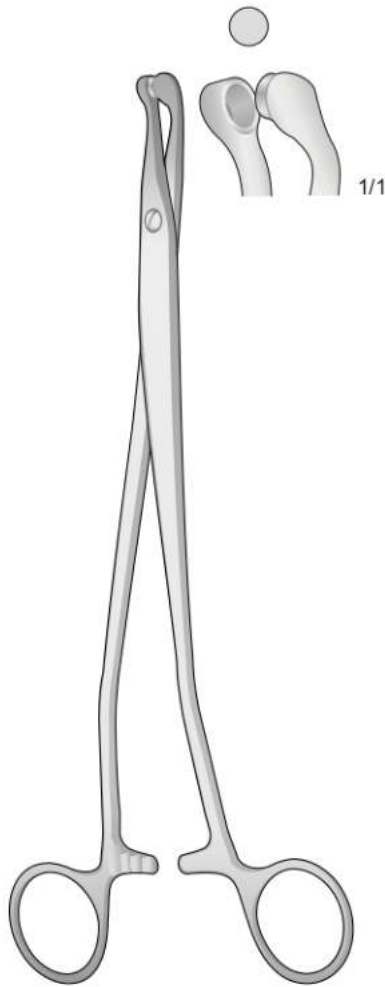
Curette per biopsia endocervicale
Endocervical Biopsy Curettes
Endocervix-Biopsieküretten



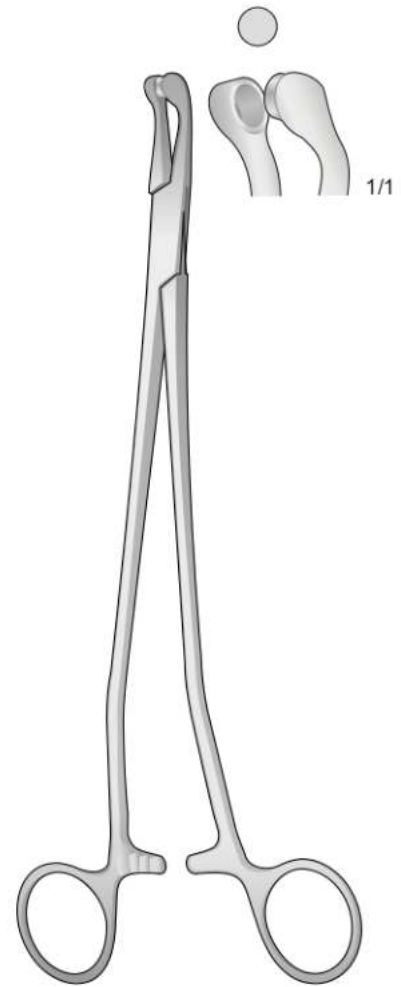
GUSBERG
ST-7093
240 mm



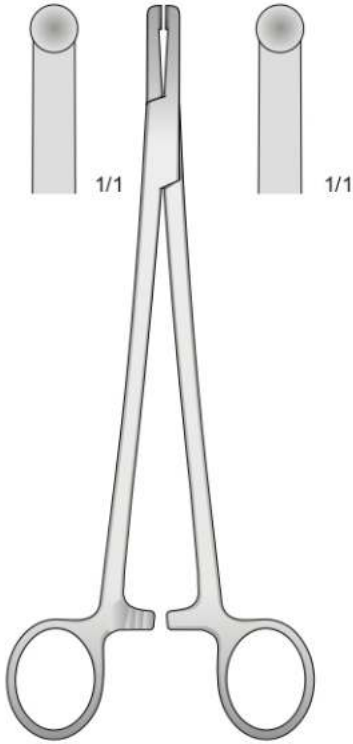
GELLHORN
ST-7094
230 mm



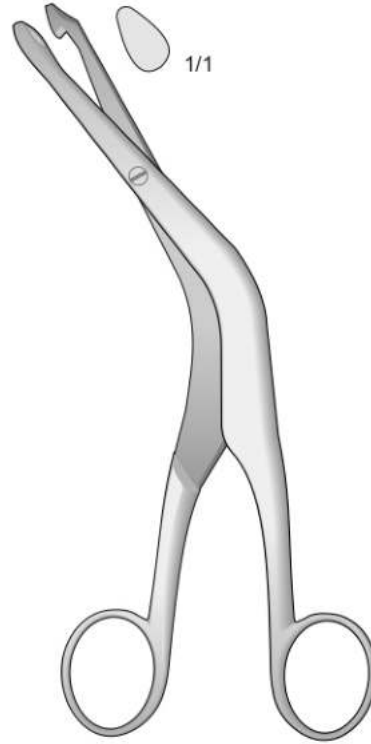
THOMS-GAYLOR
ST-7095
240 mm



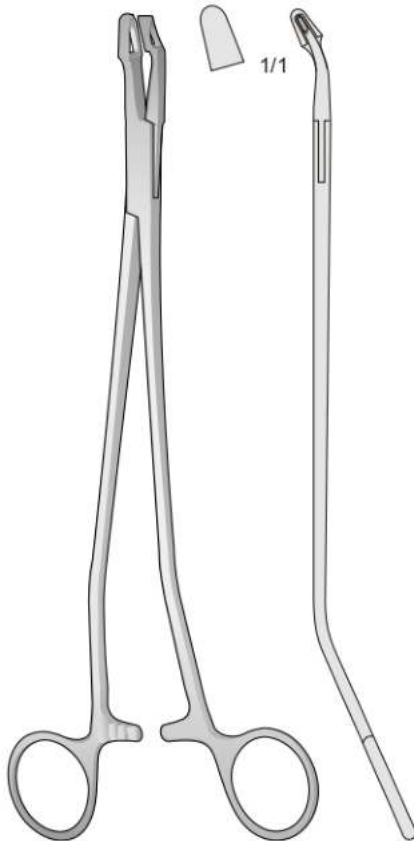
THOMS-GAYLOR
ST-7095-1 220 mm
ST-7095-2 240 mm



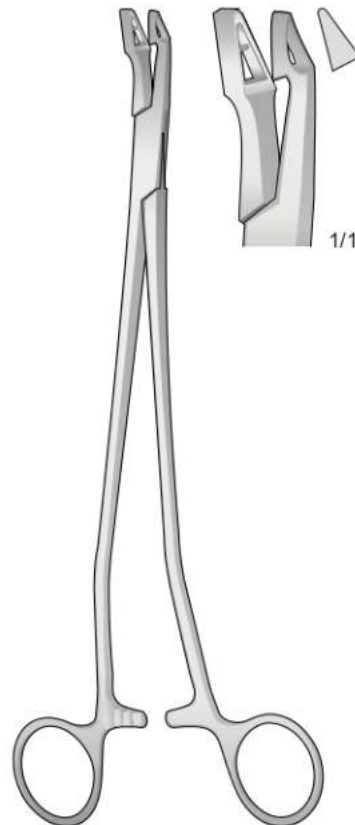
ST-7096
205 mm



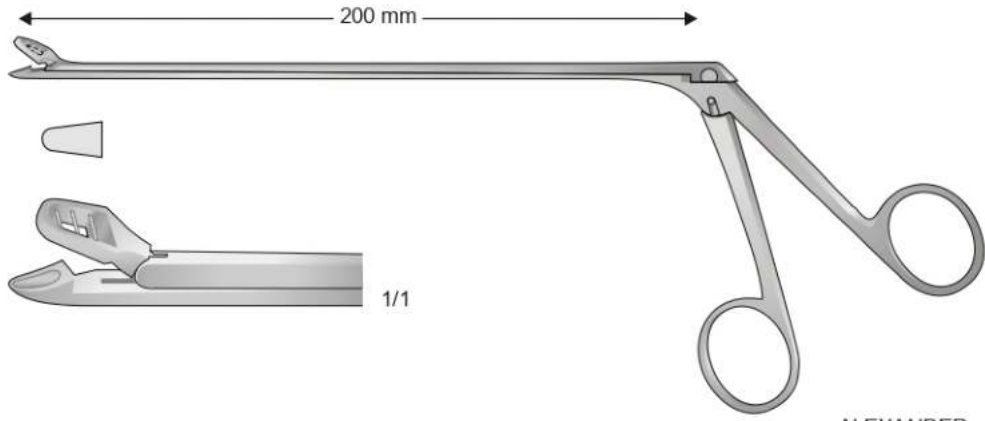
FAURE
ST-7097
210 mm



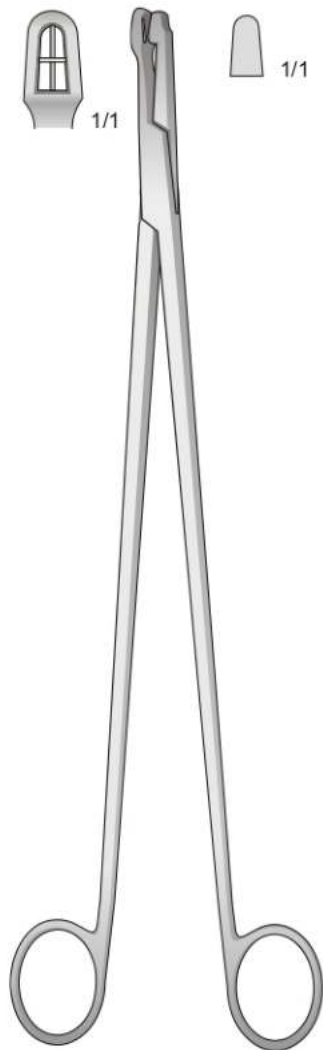
VAN DOREN
ST-7098
250 mm



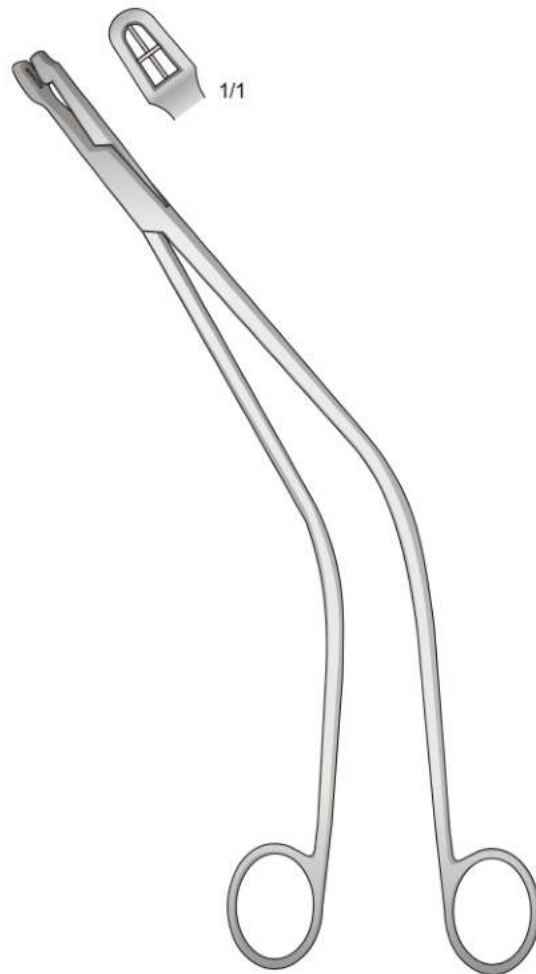
VAN DOREN
ST-7099
240 mm



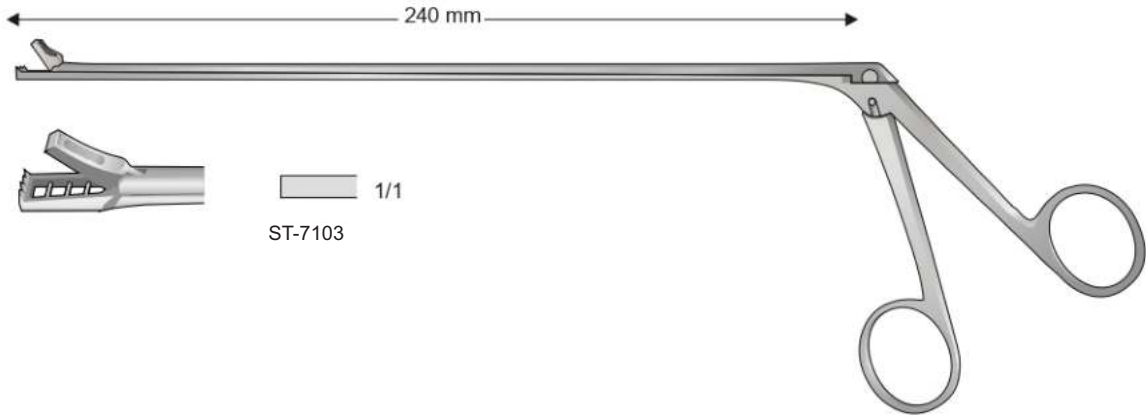
ALEXANDER
ST-7100



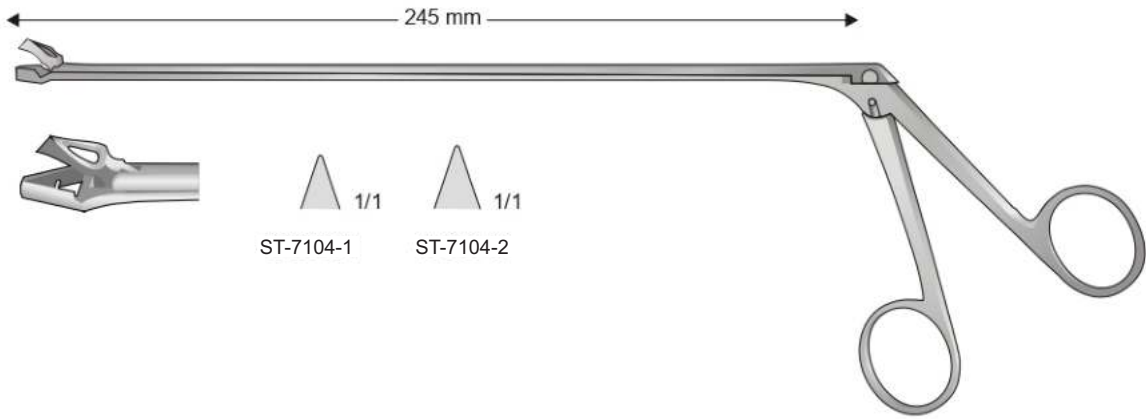
SCHUBERT
ST-7101-1 210 mm
ST-7101-2 290 mm



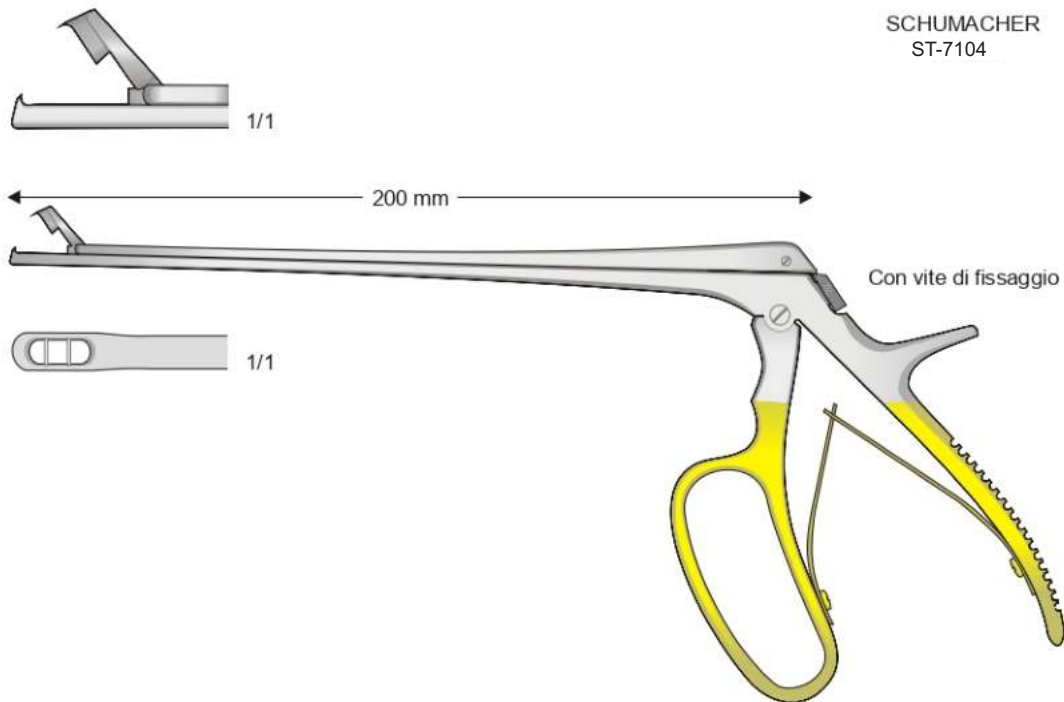
SCHUBERT
ST-7102
260 mm



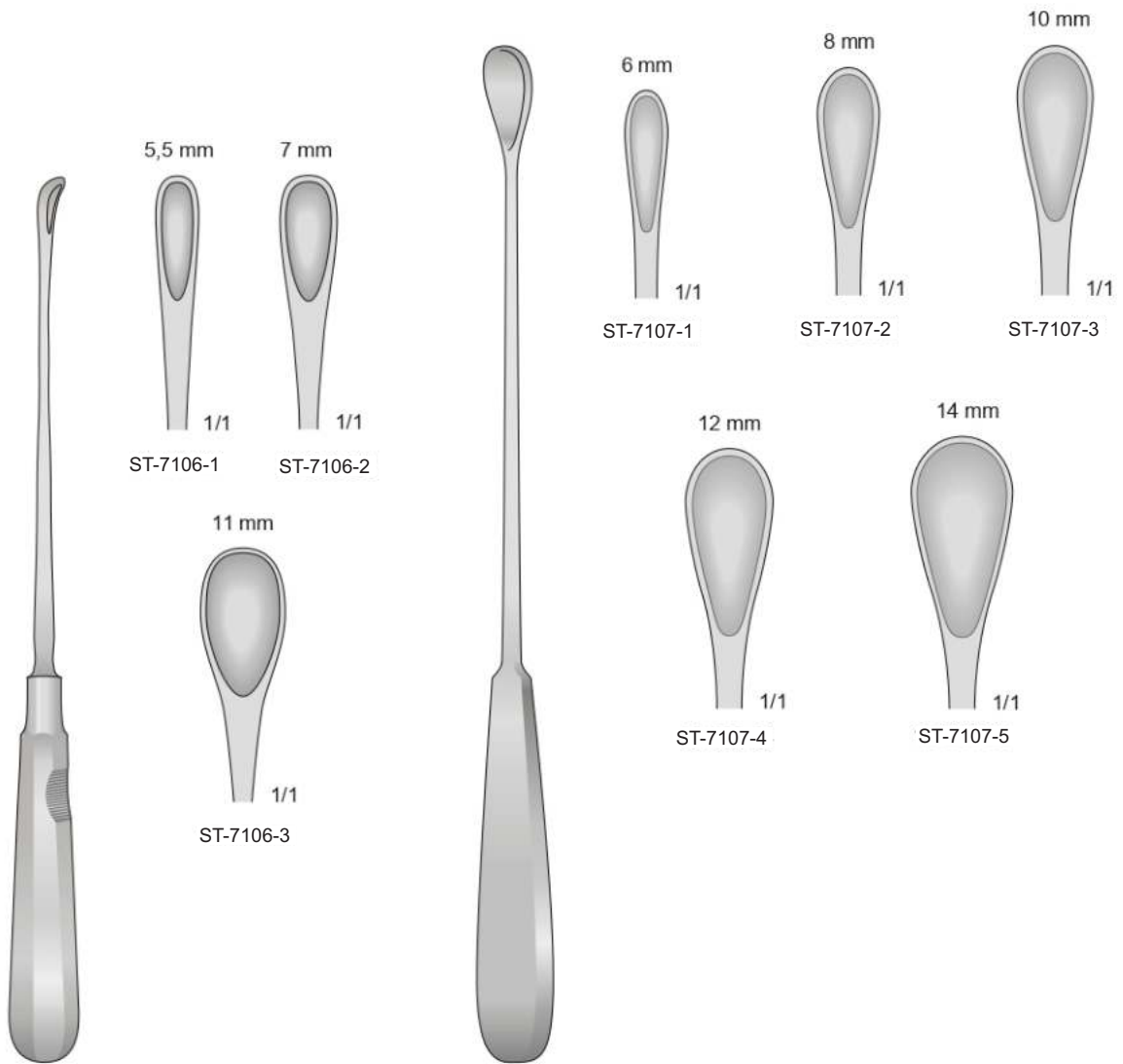
KEVORKIAN
ST-7103



SCHUMACHER
ST-7104

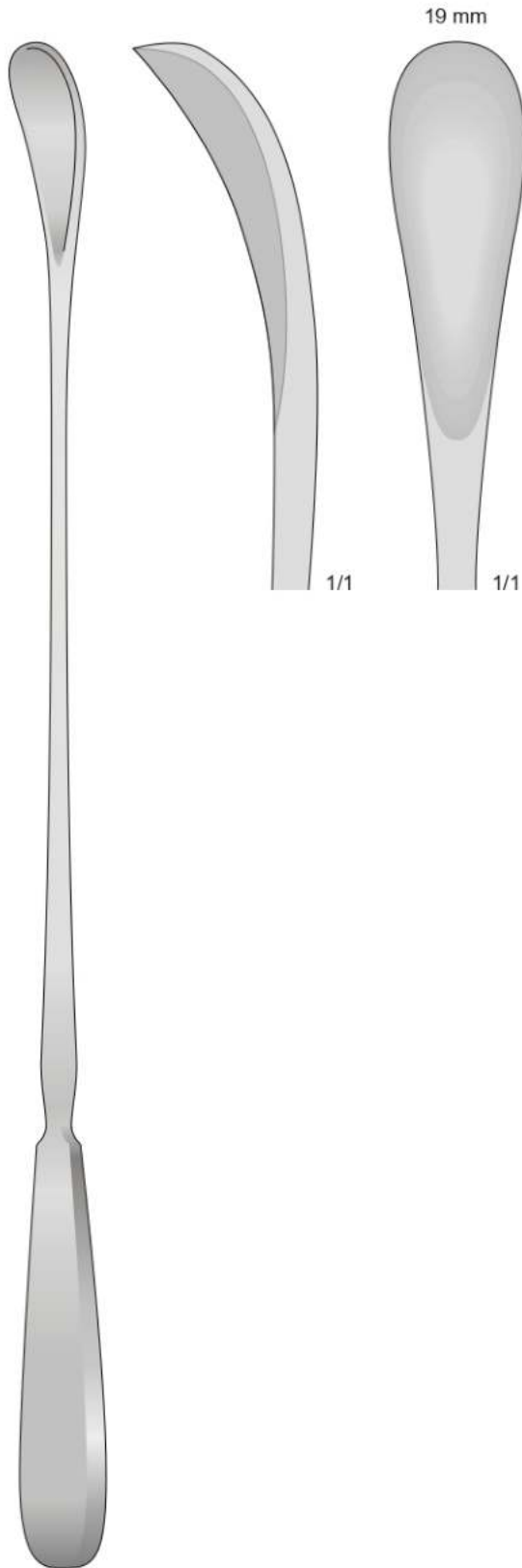


TISCHLER-MORGAN
ST-7105

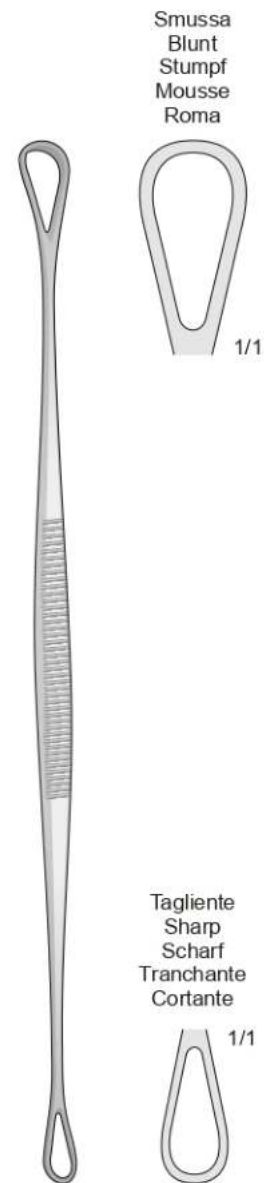


LUER-KÖRTE
ST-7106
260 mm

GOURDET
ST-7107
280 mm



WALLICH
ST-7108
420 mm



BLAKE
ST-7109
275 mm

Tagliente
Sharp
Scharf
Tranchante
Cortante

1/1



Taglienti
Scharp
Scharf
Tranchantes
Cortantes

Smussa
Blunt
Stumpf
Mousse
Romas

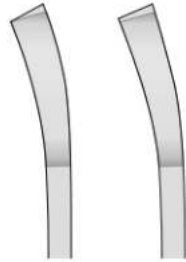
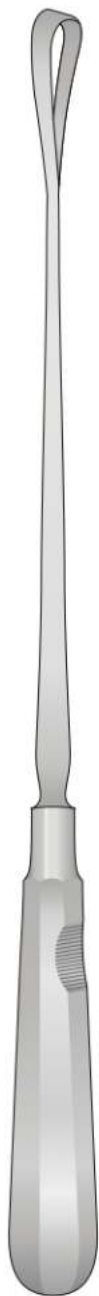
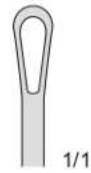


Fig. 1



1/1

Fig. 2



1/1

Fig. 3



1/1

Fig. 4



1/1

Fig. 5



1/1

Fig. 6



1/1

Fig. 7



1/1

Fig. 8



1/1

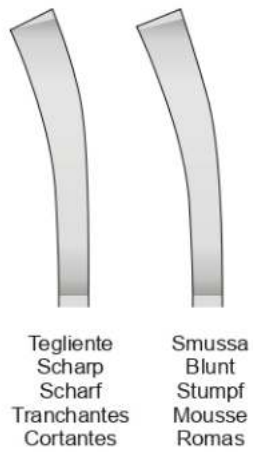
Fig.	Larghezza Width Breite	Taglienti-rigide Sharp-rigid Scharf-fest Tranchantes-rigides Cortantes-rigidas	Smusse-rigide Blunt-rigid Stumpf-fest Mousse-rigides Romas-rigidas
1	4 mm	ST-7110 -01	ST-7110 -09
2	6 mm	ST-7110 -02	ST-7110 -10
3	8 mm	ST-7110 -03	ST-7110 -11
4	10 mm	ST-7110 -04	ST-7110 -12
5	12 mm	ST-7110 -05	ST-7110 -13
6	14 mm	ST-7110 -06	ST-7110 -14
7	16 mm	ST-7110 -07	ST-7110 -15
8	18 mm	ST-7110 -08	ST-7110 -16

RECAMIER

ST-7110
310 mm



BUMM
ST-7111
310 mm



Malleabile
Malleable
Biegsam
Souples
Maleables

Fig. 3



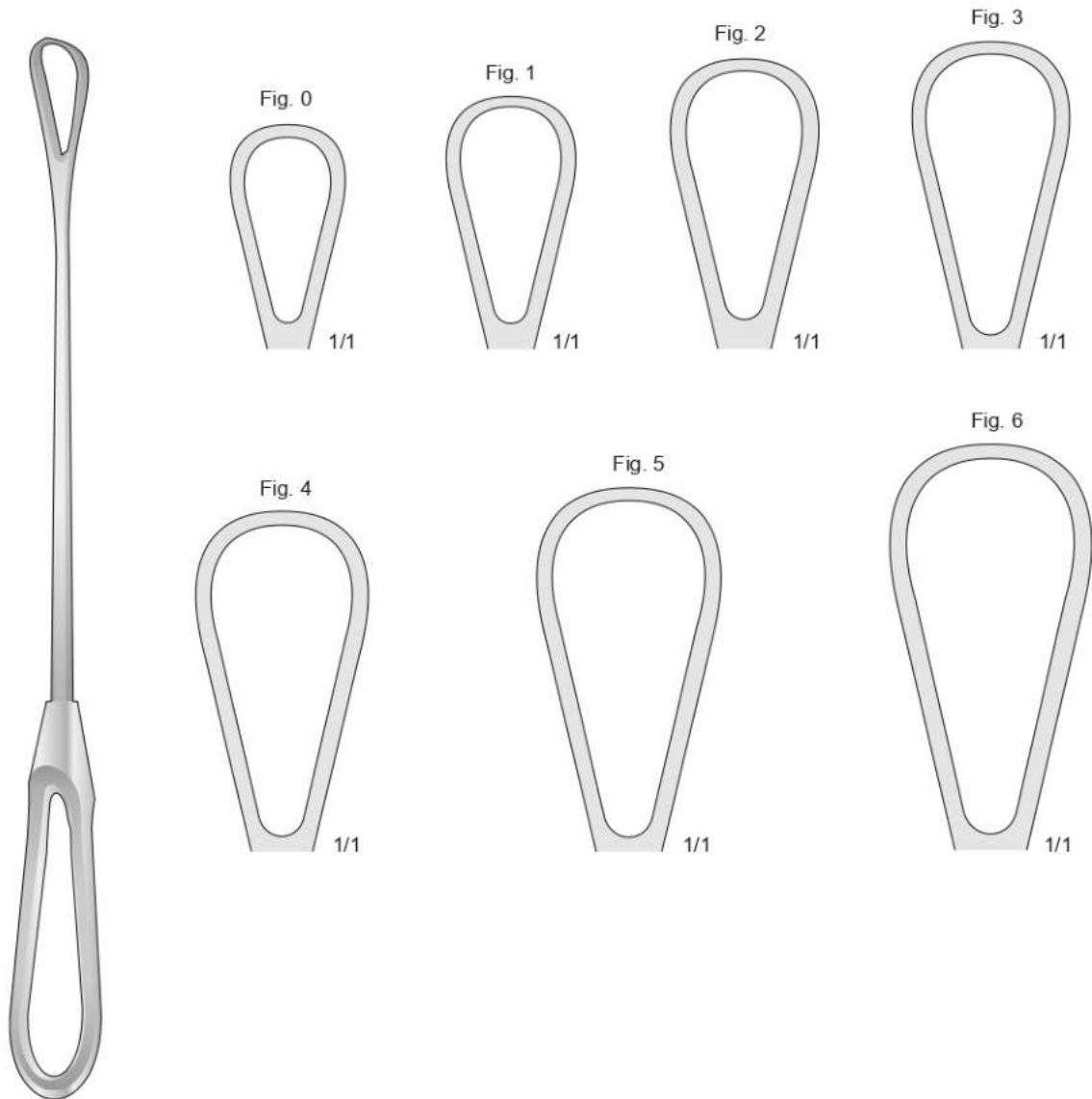
Fig. 4



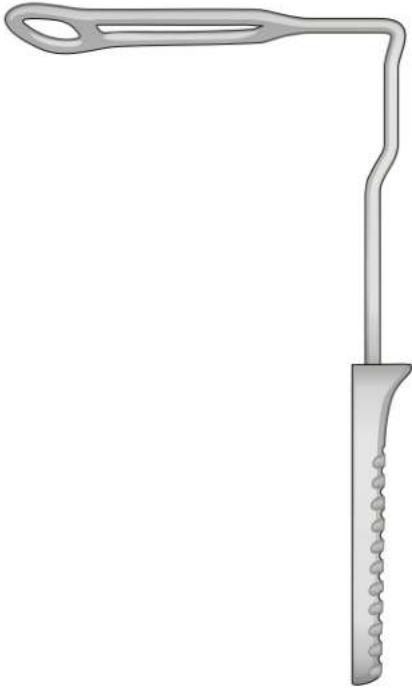
Fig.	Larghezza Width Breite	Taglienti Sharp Scharf Tranchantes Cortantes	Smusse Blunt Stumpf Mousse Romas
3	18 mm	ST-7111-1	ST-7111-3
4	20 mm	ST-7111-2	ST-7111-4



Fig.	Larghezza Breite Width	Smusse malleabili - Blunt malleable Stumpf biegsam - Mousse malléables Romas maleables
0	16 mm	ST-7112 -01
1	18 mm	ST-7112 -02
2	19,5 mm	ST-7112 -03
3	21,5 mm	ST-7112 -04
4	23,5 mm	ST-7112 -05
5	26 mm	ST-7112 -06
6	28,5 mm	ST-7112 -07



BUMM
ST-7112
290 mm



GENTOFT
ST-7113
210 mm

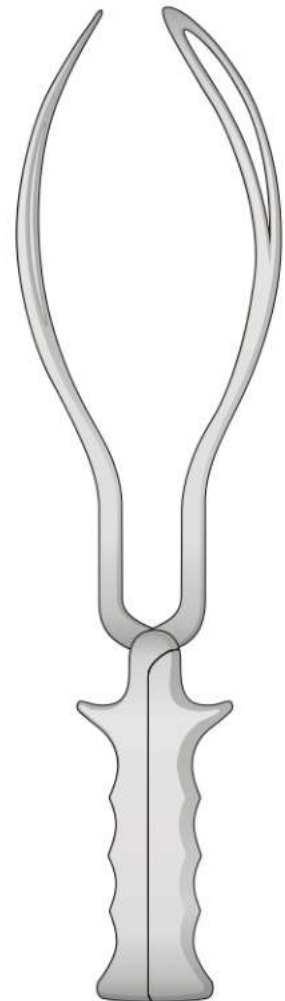
Set 2 pezzi
Set 2 pieces
Set 2 Stück
Set 2 pièces
Set 2 piezas
15-930



FENO
ST-7114
230 mm



ST-7115
230 mm



SIMPSON-BRAUN
ST-7116
365 mm



SAFE TOOL
MANUFACTURER & EXPORTER

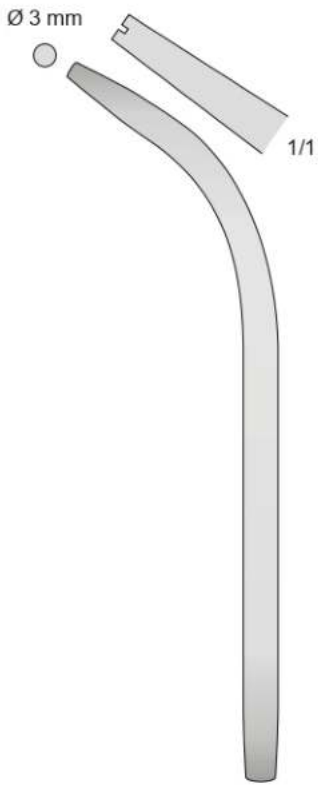


Suction Tubes

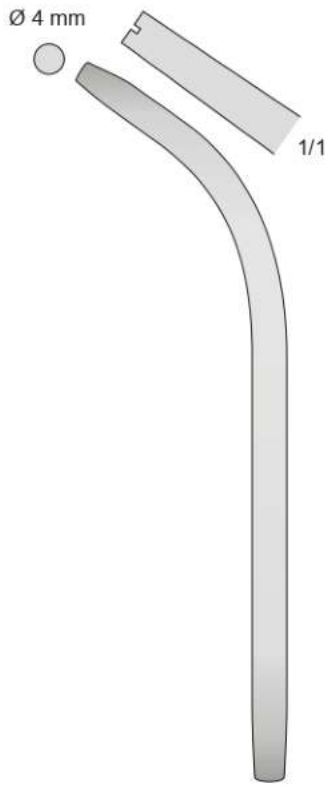


www.safetool.com.pk

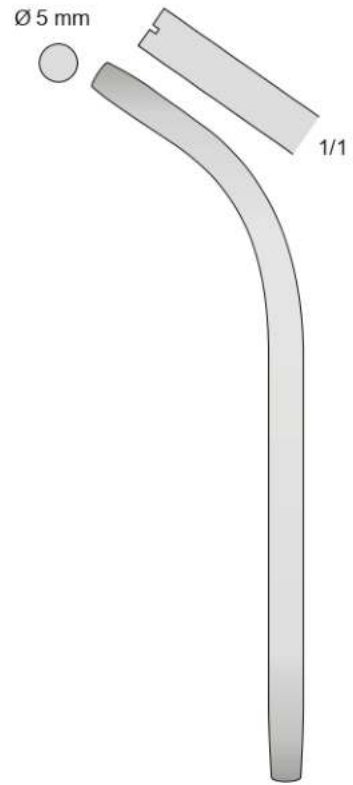
**Surgical
Instruments**



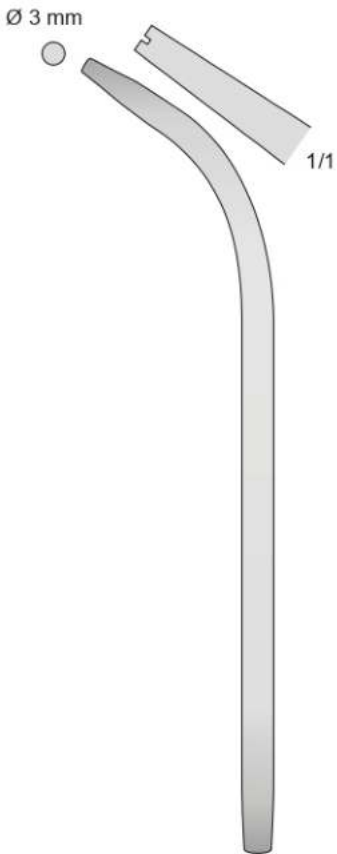
ST-9901-1
140 mm



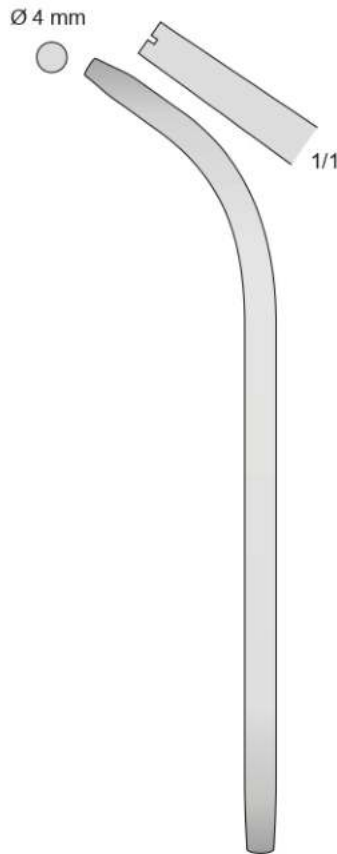
ST-9901-2
140 mm



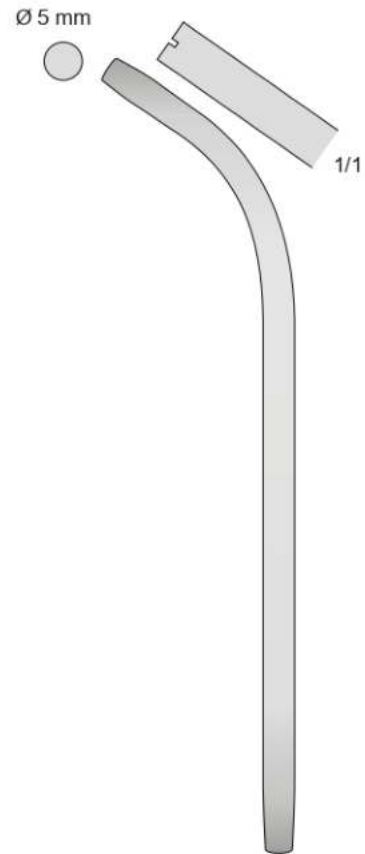
ST-9901-3
140 mm



ST-9902-1
170 mm

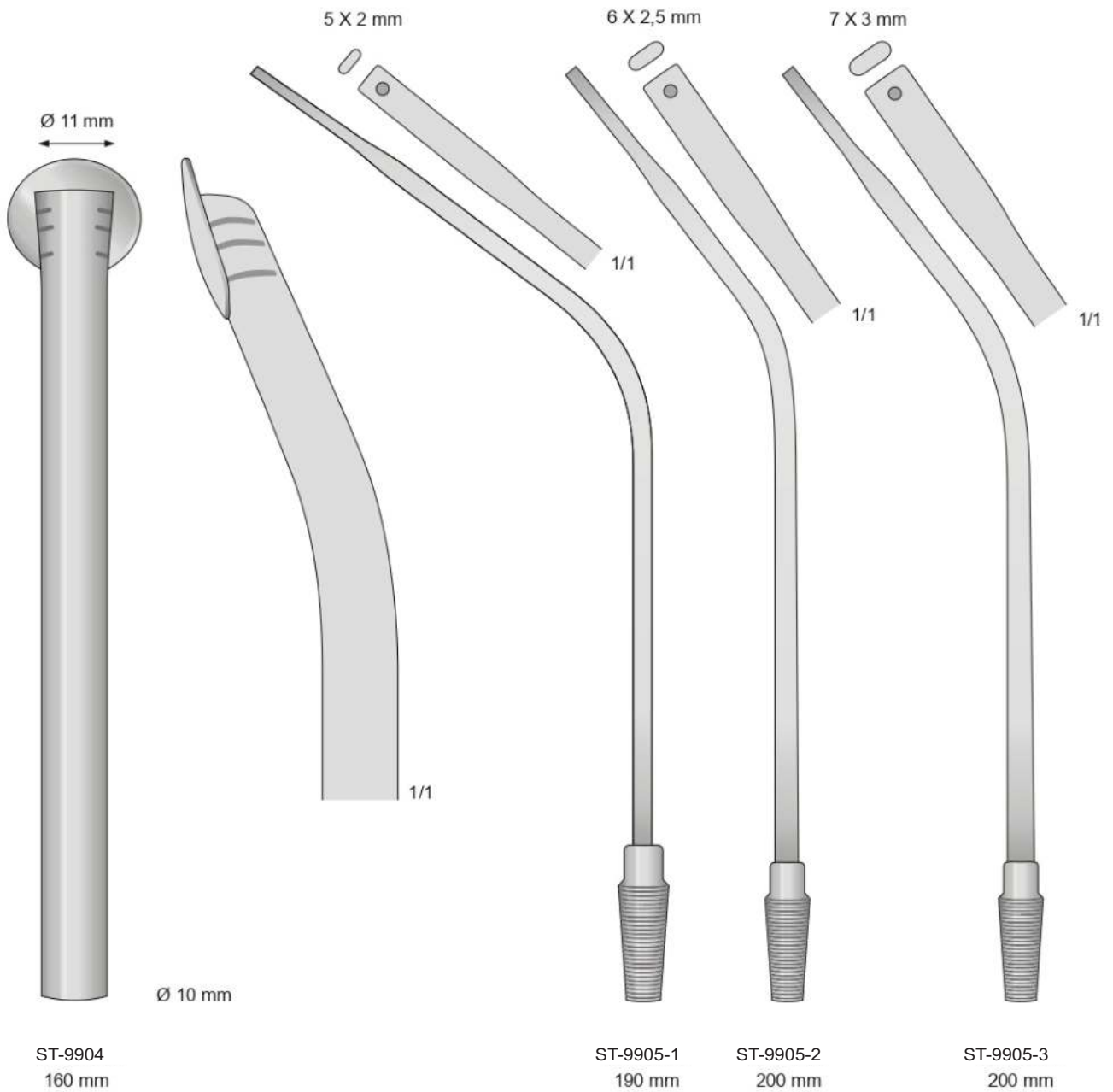


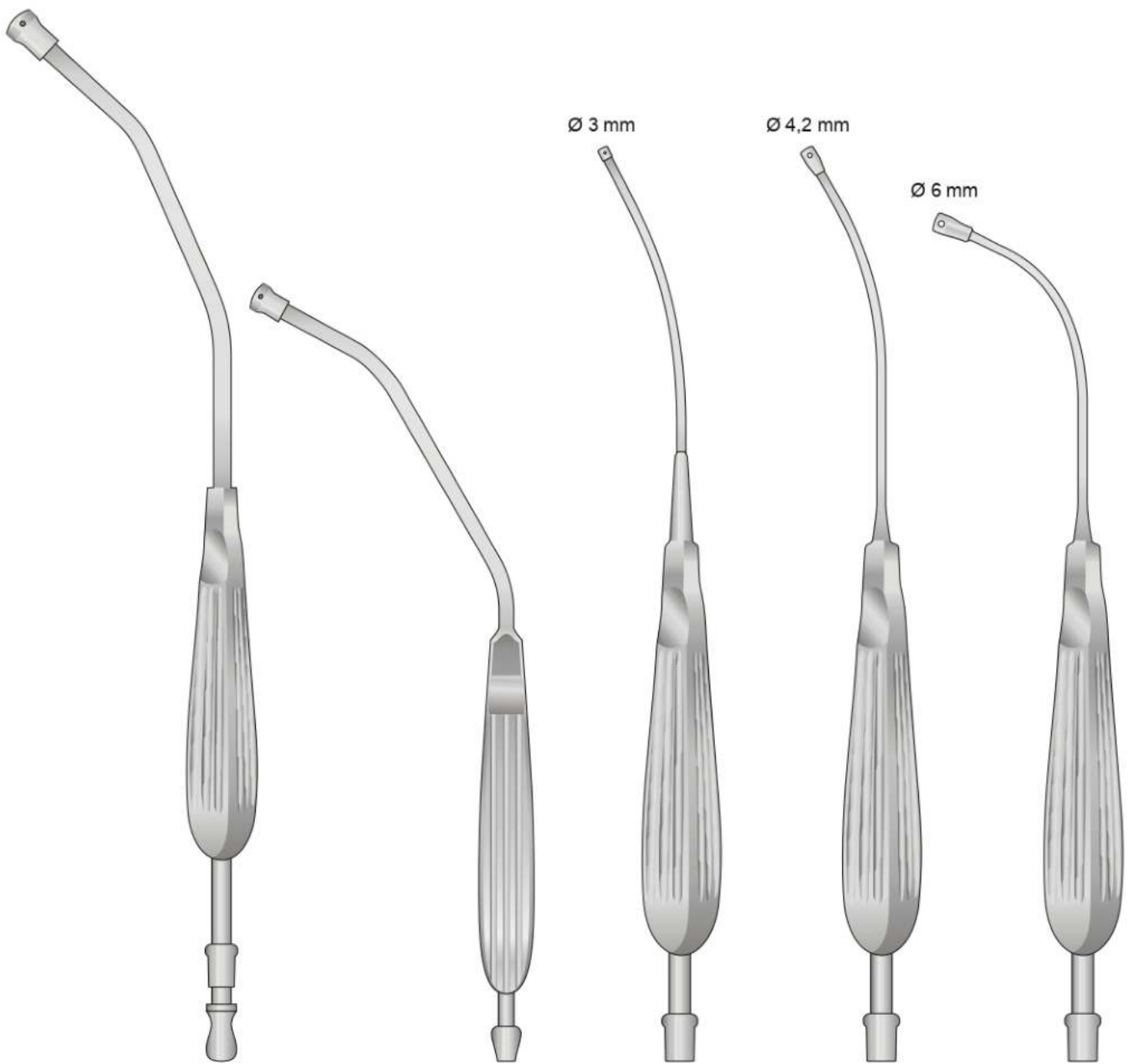
ST-9902-2
170 mm



ST-9902-3
170 mm







YANKAUER
ST-9906
310 mm

BABY-YANKAUER
ST-9907-1
200 mm

ANDREWS-PYNCHON
ST-9907-2
250 mm

ANDREWS-PYNCHON
ST-9907-3
250 mm

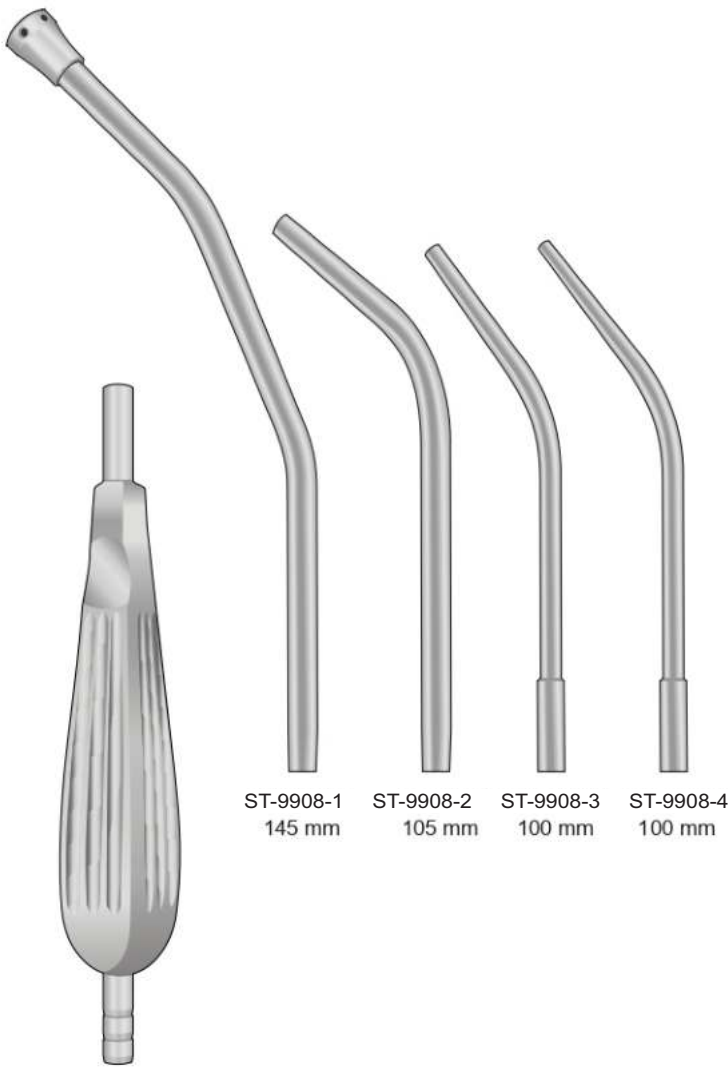
ANDREWS-PYNCHON
ST-9907-4
230 mm

Manico portacanule
Set - Satz - Jeu - Jeugo

Completo con 4 canule
Complet with 4 tubes
Komplett mit 4 Kanülen
Complete avec 4 canules
Completo con 4 cânulas

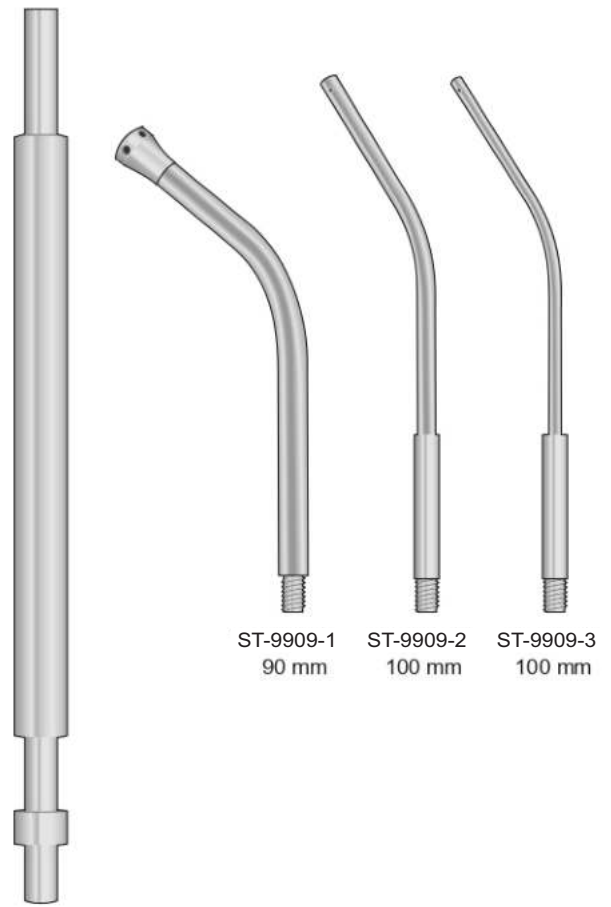
Manico portacanule
Set - Satz - Jeu - Jeugo

Completo con 3 canule
Complet with 3 tubes
Komplett mit 3 Kanülen
Complete avec 3 canules
Completo con 3 cânulas



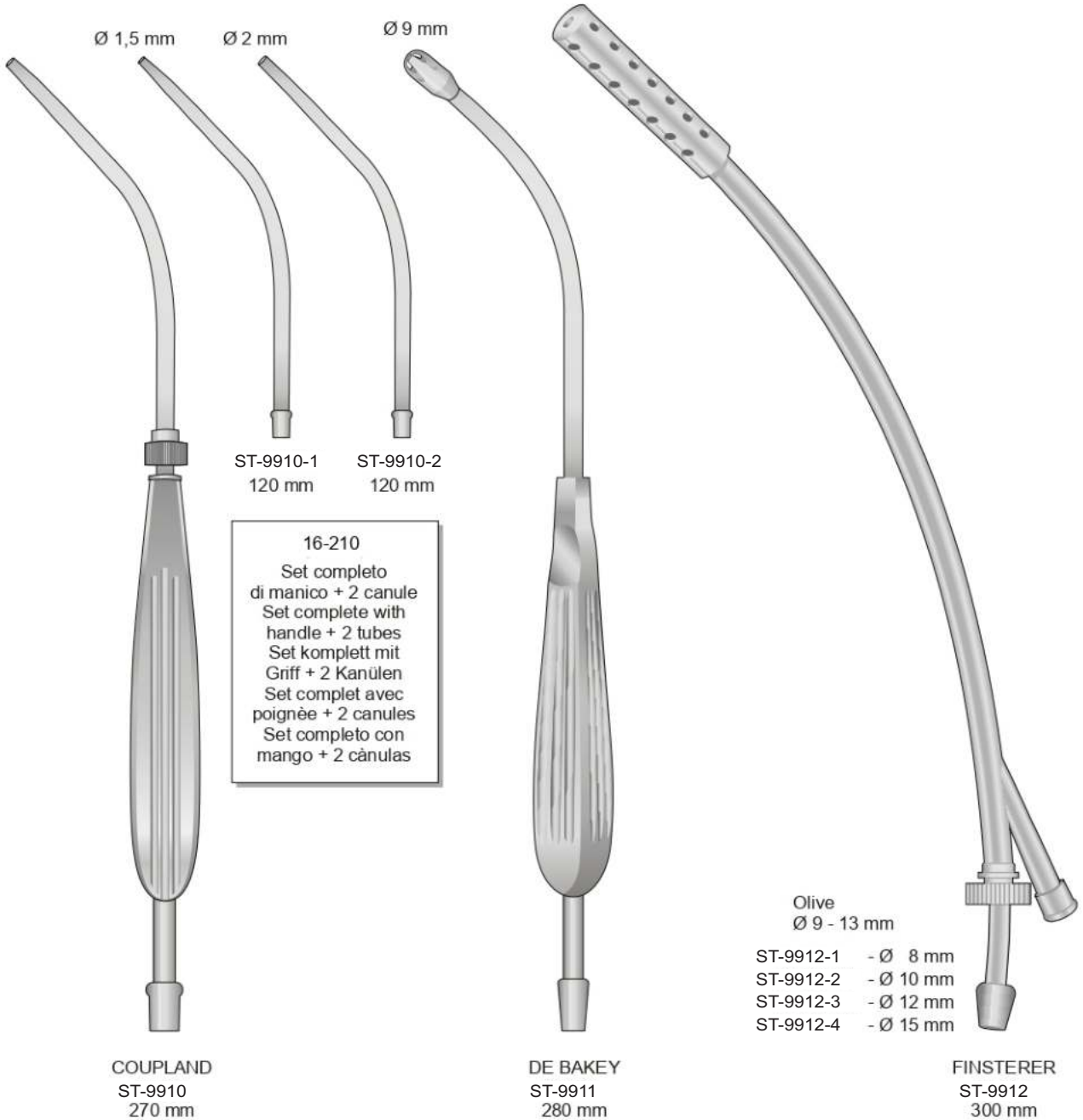
ST-9908-1 145 mm
ST-9908-2 105 mm
ST-9908-3 100 mm
ST-9908-4 100 mm

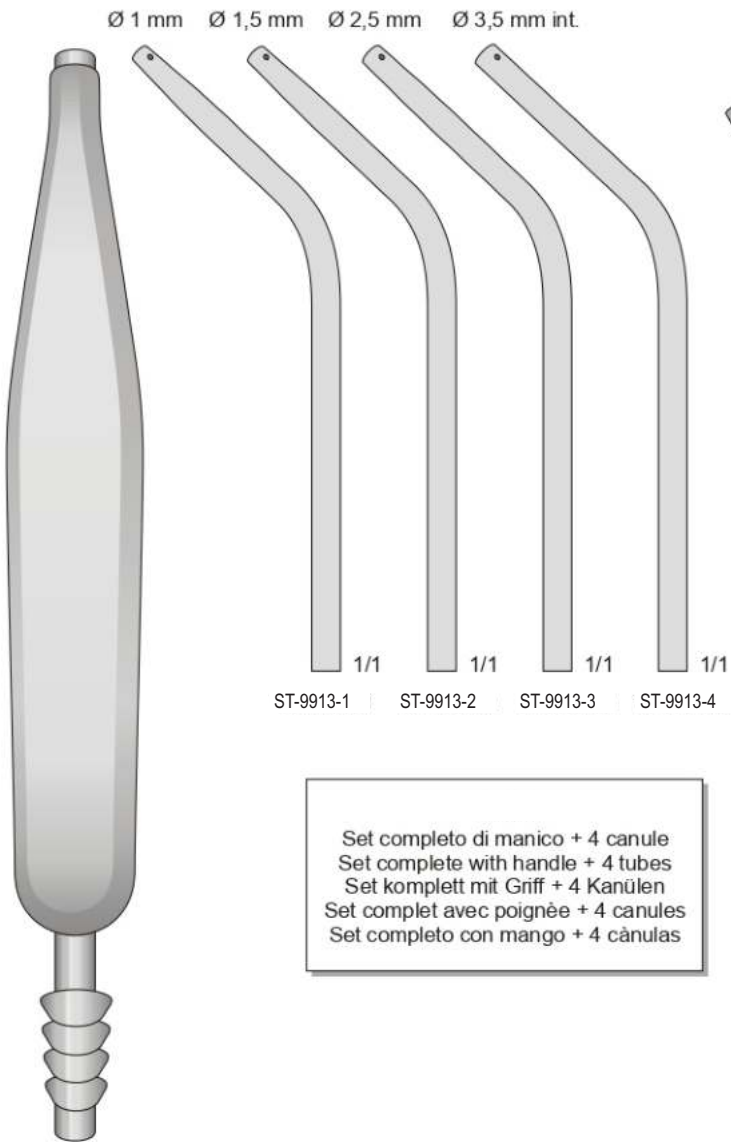
ST-9908
150 mm



ST-9909-1 90 mm
ST-9909-2 100 mm
ST-9909-3 100 mm

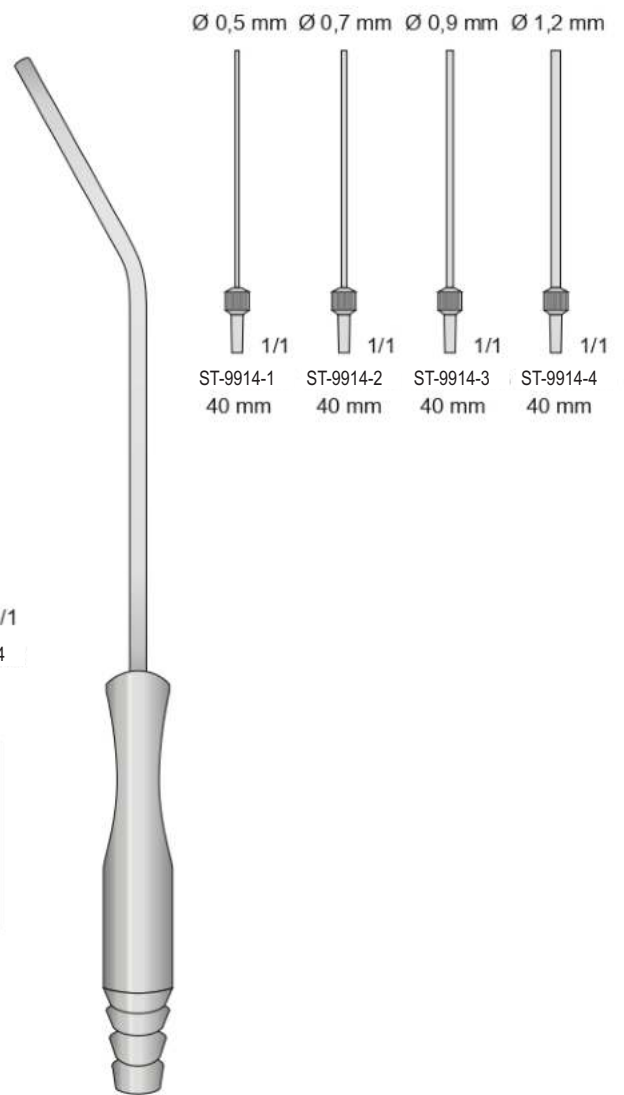
ST-9909
170 mm





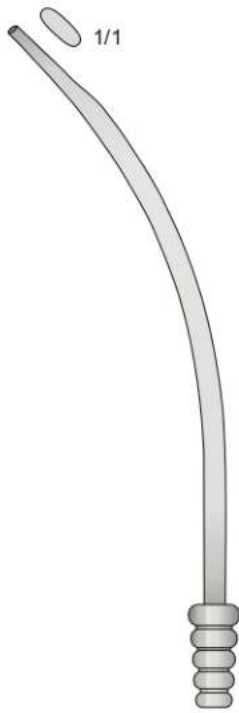
Set completo di manico + 4 canule
Set complete with handle + 4 tubes
Set komplett mit Griff + 4 Kanülen
Set complet avec poignée + 4 canules
Set completo con mango + 4 cânulas

COUPLAND
ST-9913
150 mm



WULLSTEIN
ST-9914
140 mm

Acciaio chirurgico - Stainless steel - Rostfrei - Acier - Acero



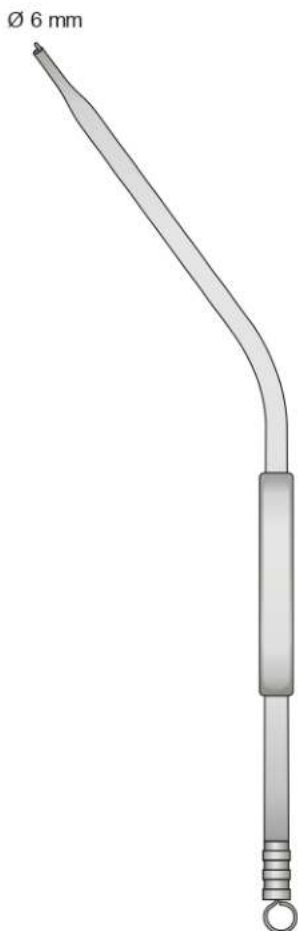
ST-9915
180 mm



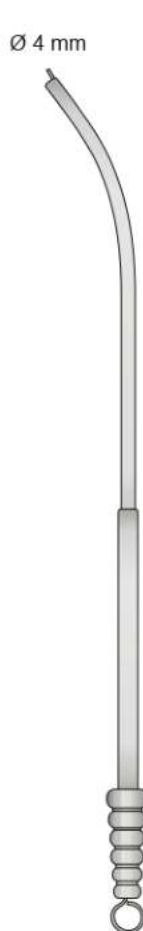
ST-9916
175 mm



ST-9917
230 mm



ST-9918
240 mm



ST-9919
230 mm



NUBOER
ST-9920
210 mm



NUBOER
ST-9921
210 mm



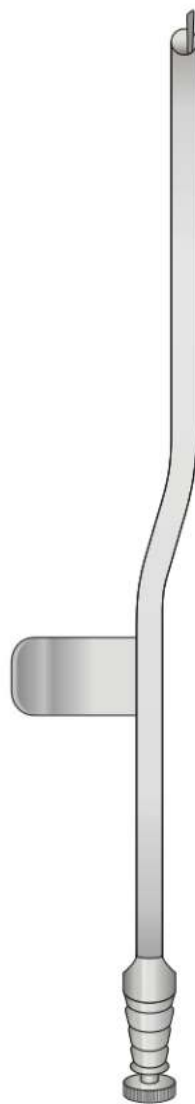
Raschiotti



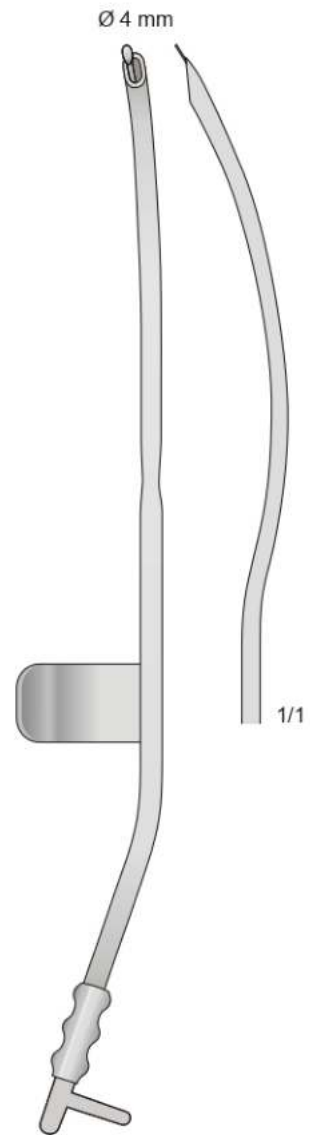
GORNEY
ST-9922
180 mm



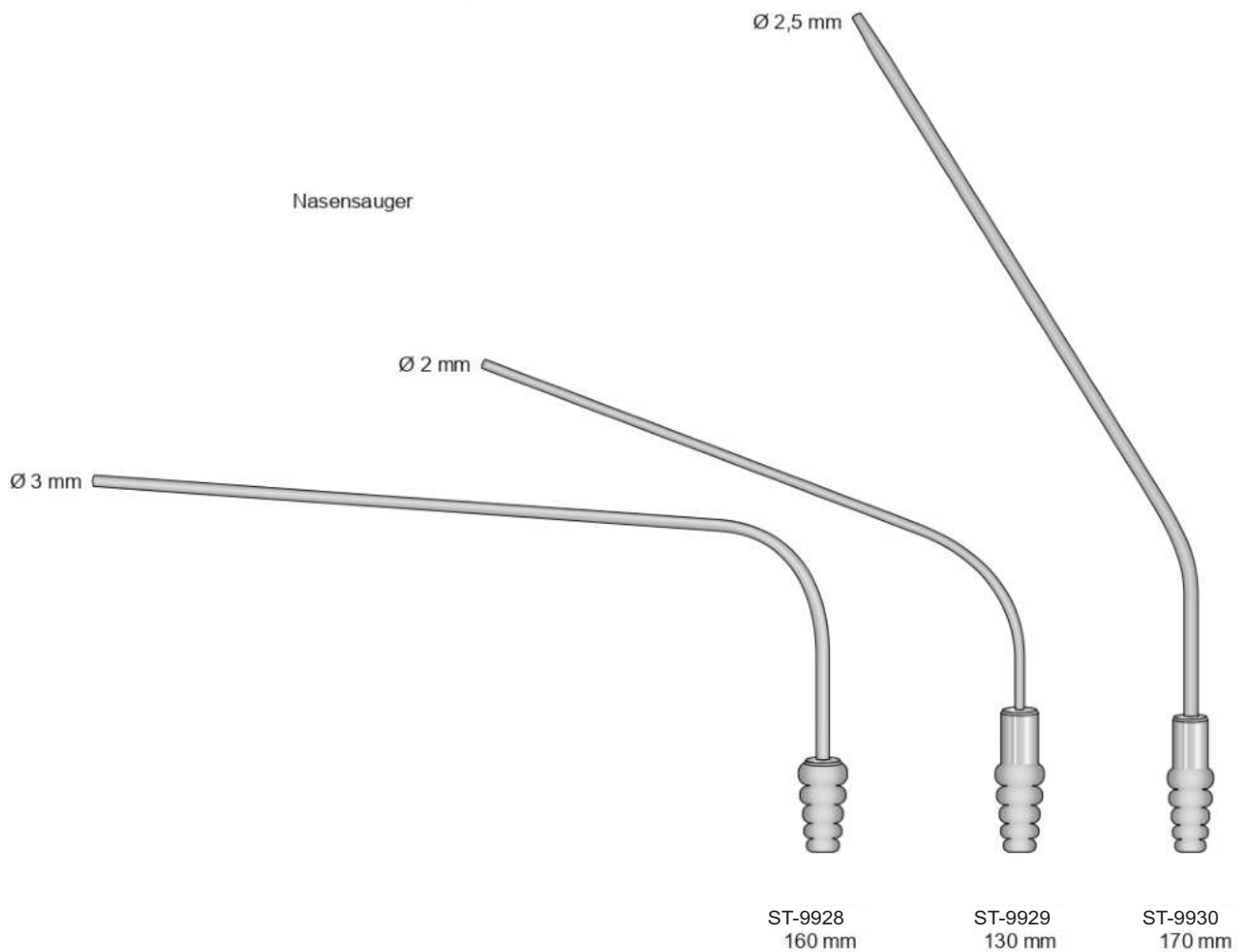
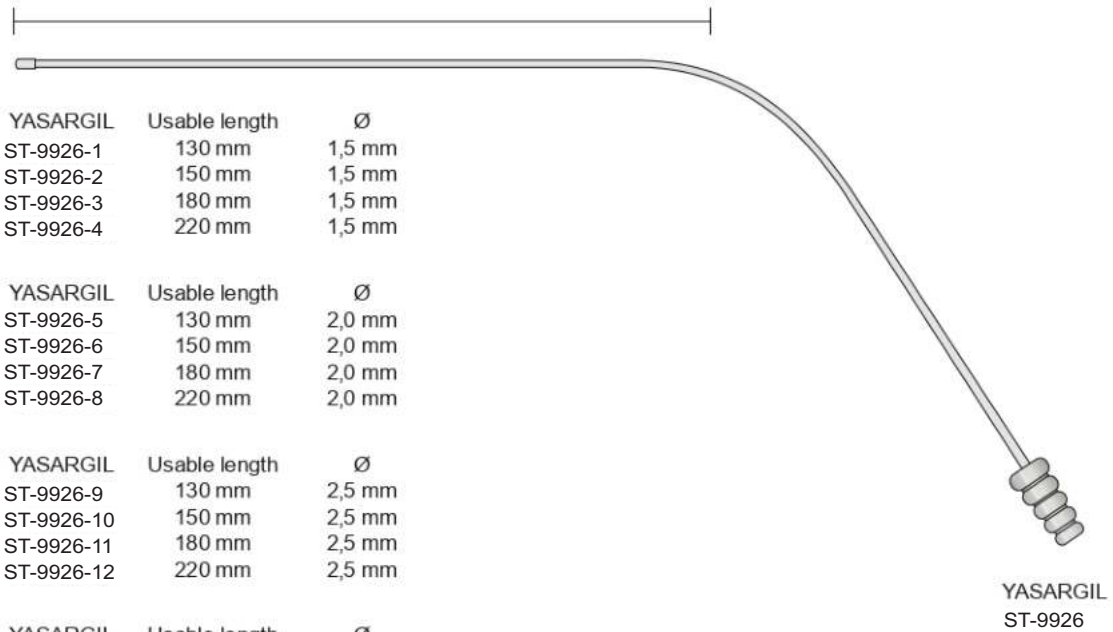
GORNEY
ST-9923
200 mm



SAUG-RASPATORIUM
ST-9924-1 Ø 4 mm
ST-9924-2 Ø 5 mm
200 mm
ST-9924



GUILLIEN
ST-9925
200 mm



Char. 6	= 2 mm
Char 7	= 2,5 mm
Char 9	= 3 mm
Char 10	= 3,3 mm
Char 12	= 4 mm
Char 15	= 5 mm

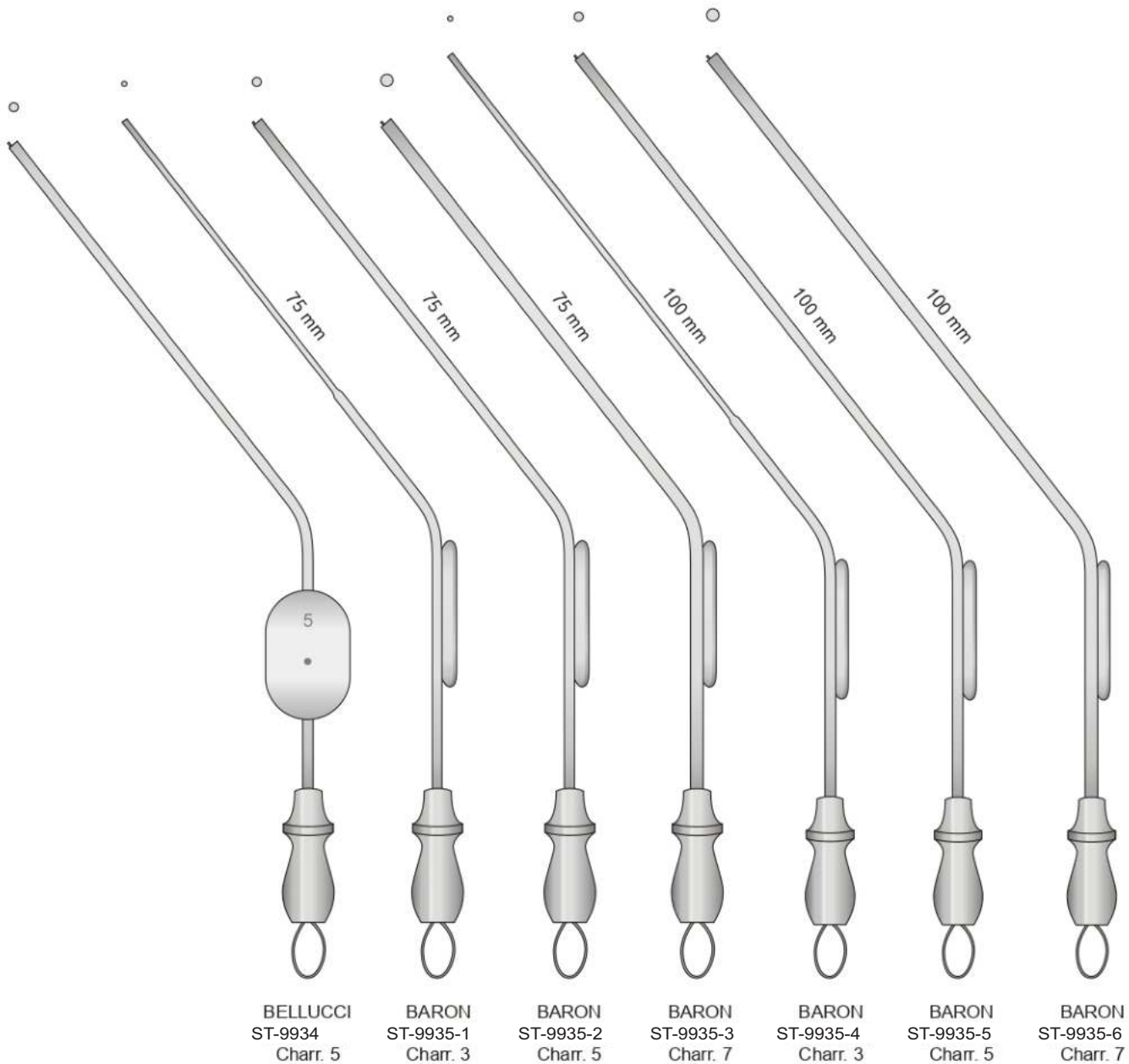


FERGUSON
 ST-9931-1 Ch. 6
 ST-9931-2 Ch. 7
 ST-9931-3 Ch. 9
 ST-9931-4 Ch. 12
 ST-9931-5 Ch. 15
 180 mm

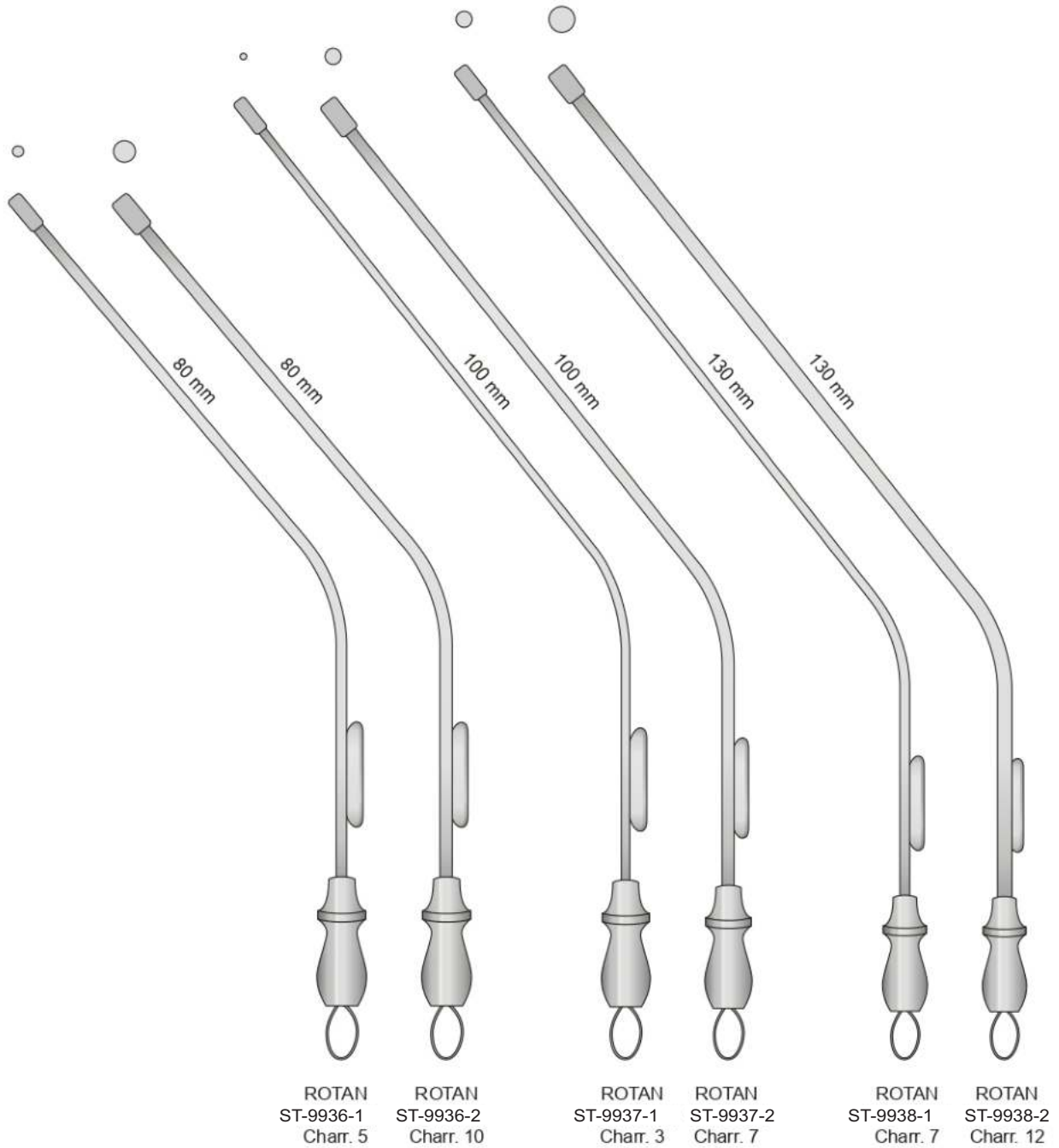
FRAZIER
 ST-9932-1 Ch. 6
 ST-9932-2 Ch. 7
 ST-9932-3 Ch. 9
 ST-9932-4 Ch. 12
 ST-9932-5 Ch. 15
 180 mm

PLESTER
 ST-9933-1 Ch. 6
 ST-9933-2 Ch. 7
 ST-9933-3 Ch. 9
 ST-9933-4 Ch. 12
 ST-9933-5 Ch. 15
 200 mm

Char. 3	= 1 mm
Char 5	= 1,7 mm
Char 7	= 2,5 mm
Char 10	= 3,3 mm
Char 12	= 4 mm

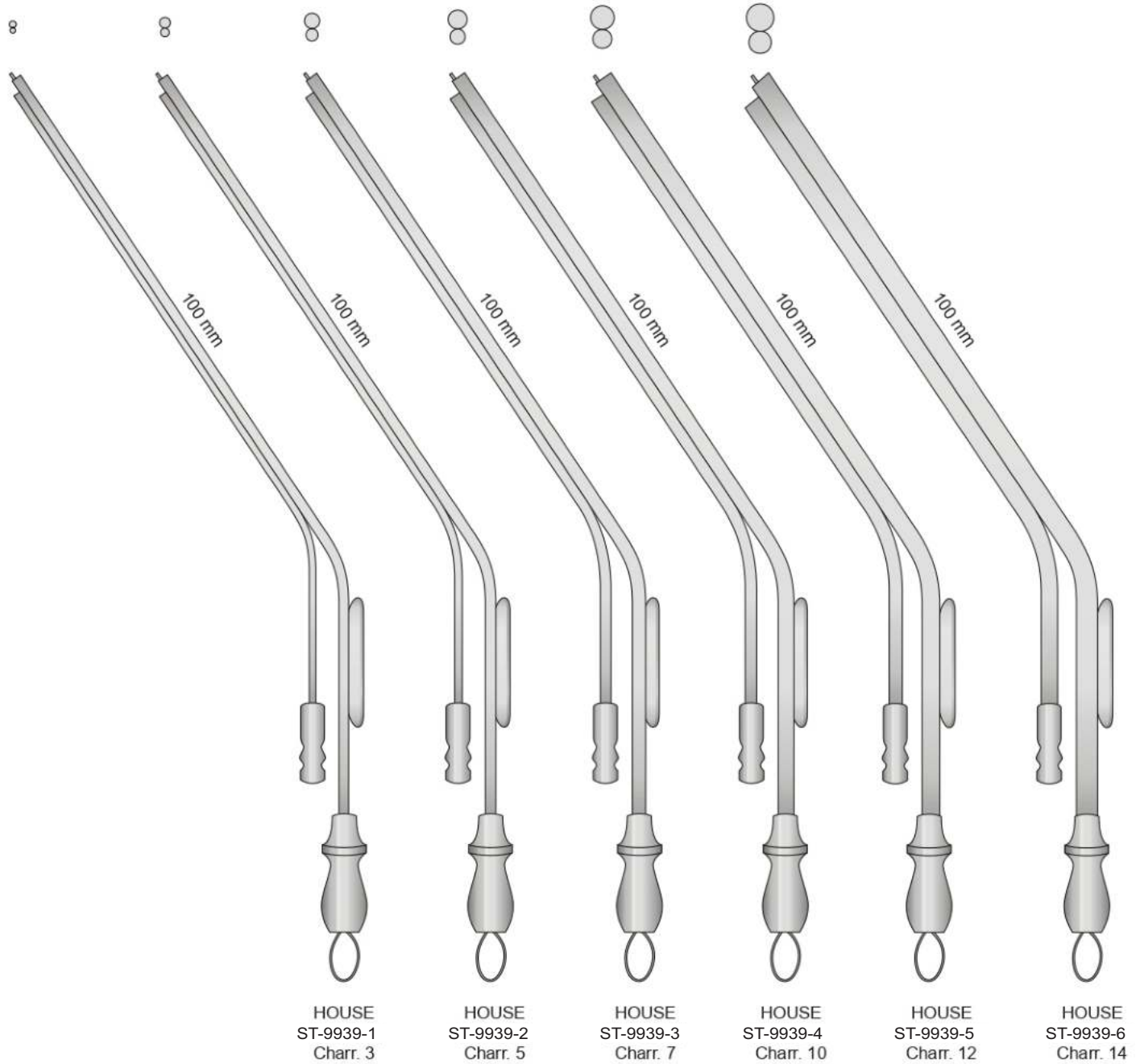


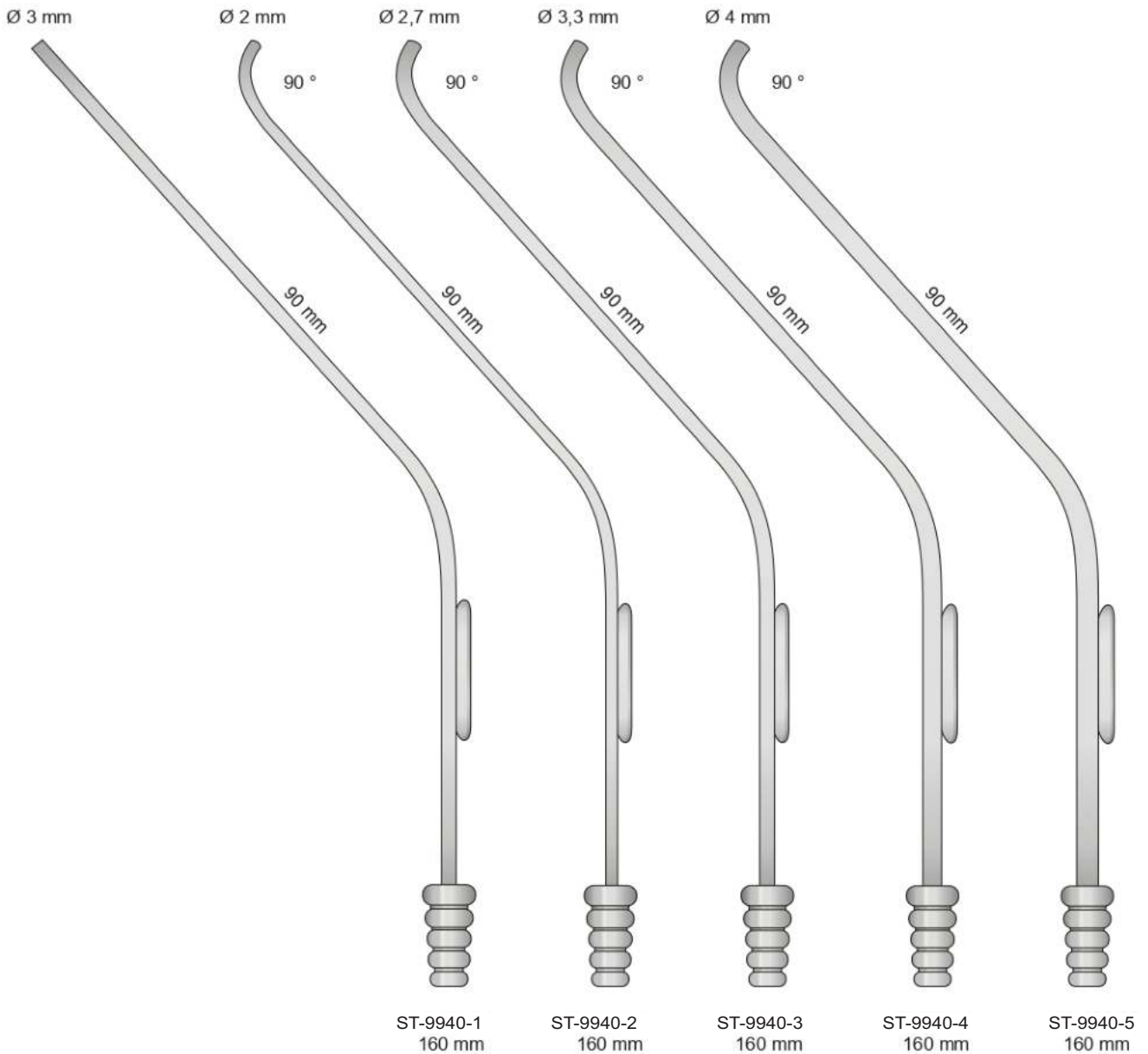
Char. 3	= 1 mm
Char 5	= 1,7 mm
Char 7	= 2,5 mm
Char 10	= 3,3 mm
Char 12	= 4 mm





Char. 3	= 1 mm
Char 5	= 1,7 mm
Char 7	= 2,5 mm
Char 10	= 3,3 mm
Char 12	= 4 mm
Char 14	= 4,6 mm





Malleabile
Malleable
Biegsam
Malléables
Malleable
Ø 3 mm



WERTHEIMER
ST-9941
160 mm

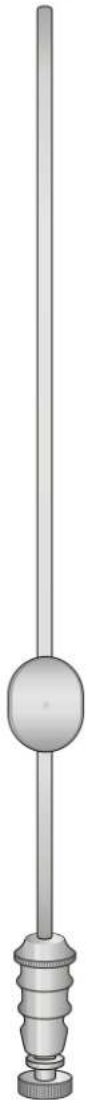
Cromata nera

Malleabile
Malleable
Biegsam
Malléables
Malleable
Ø 3 mm



FRAZIER
ST-9942
160 mm

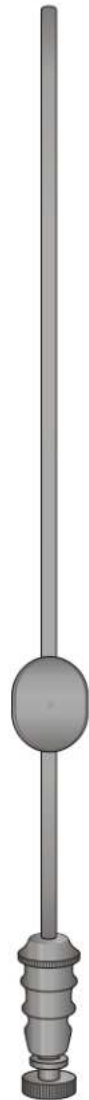
Malleabile
Malleable
Biegsam
Malléables
Malleable
Ø 3 mm



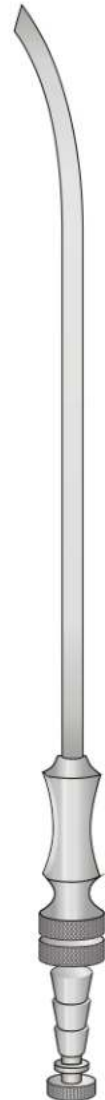
WERTHEIMER
ST-9943
200 mm

Cromata nera

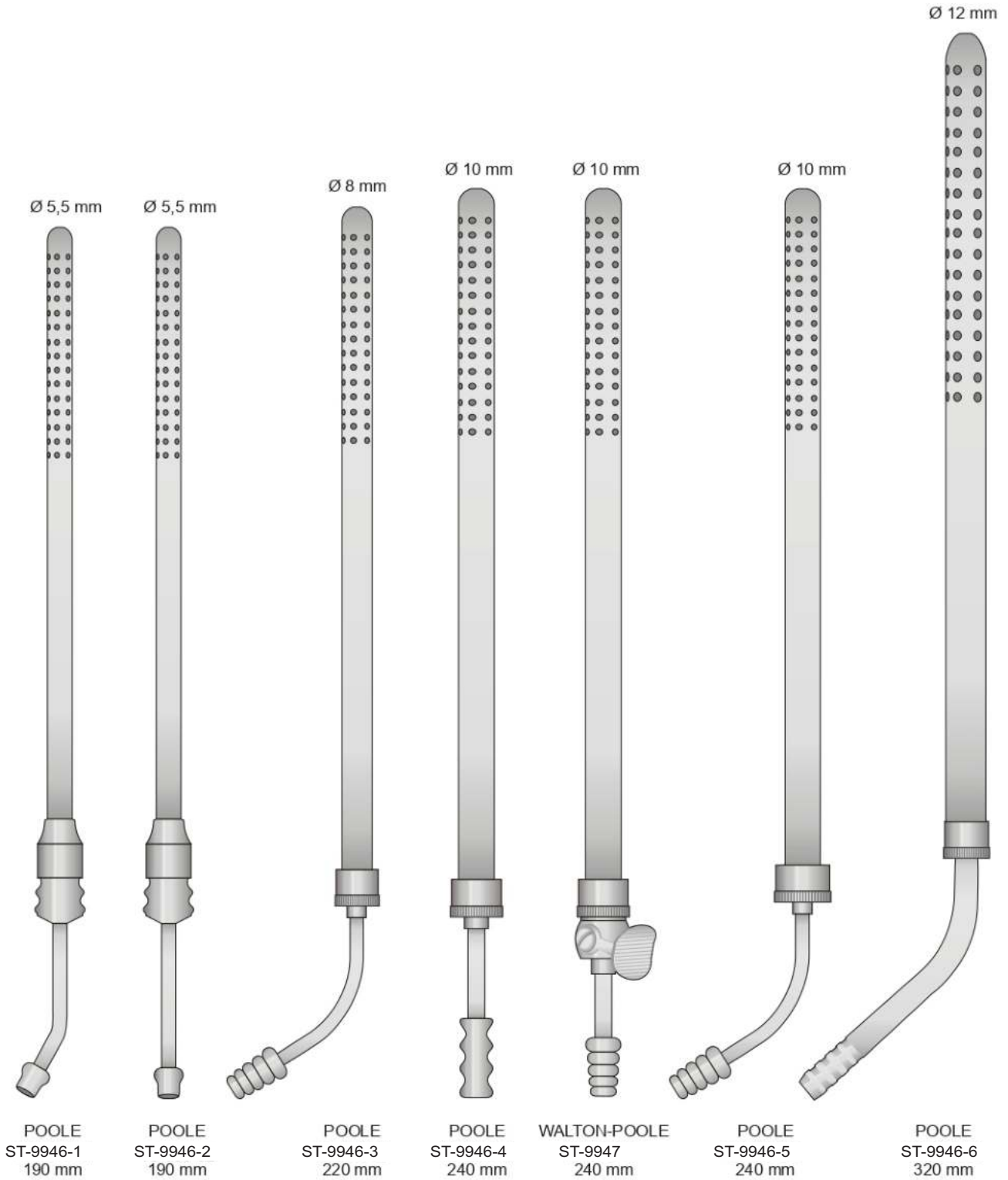
Malleabile
Malleable
Biegsam
Malléables
Malleable
Ø 3 mm



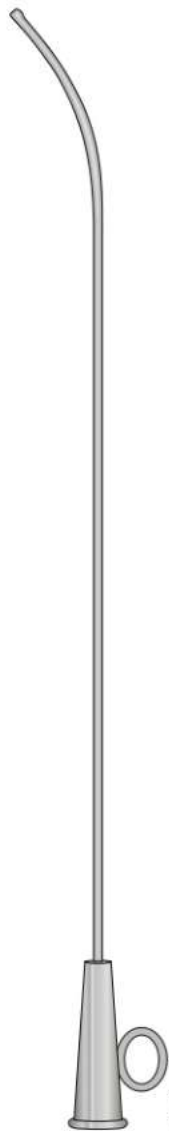
FRAZIER
ST-9944
200 mm



ADSON
ST-9945-1 ch. 12
ST-9945-2 ch. 15
210 mm
16-470



Set completo con:
Set complete with:
Kompletset mit:
Set complet avec:
Set completos con:

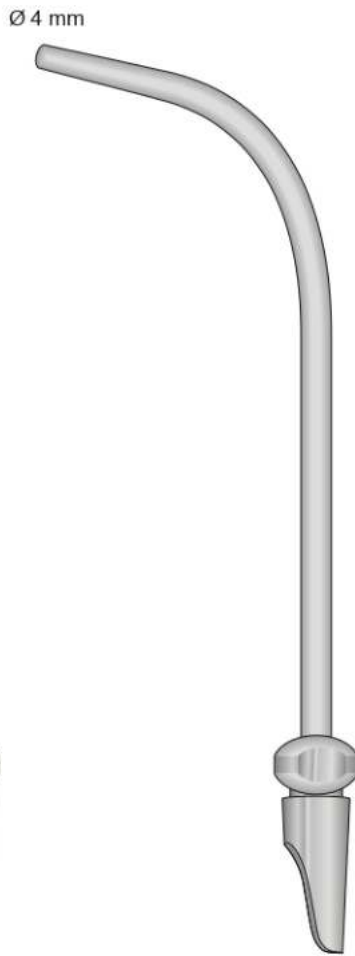


HARTMANN
ST-9948
170 mm

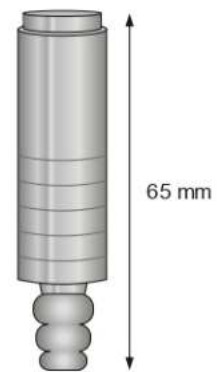
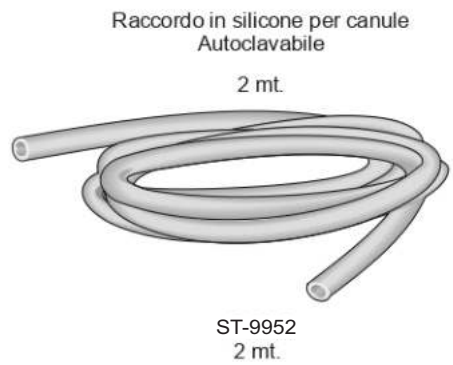
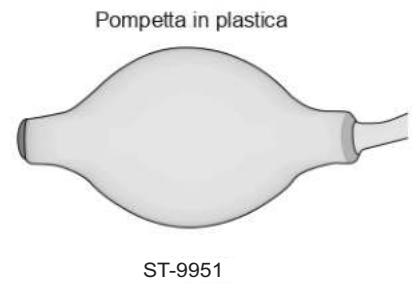
- ST-9948-1 Ø 1,5 mm
- ST-9948-2 Ø 2 mm
- ST-9948-3 Ø 2,5 mm



ST-9949
160 mm



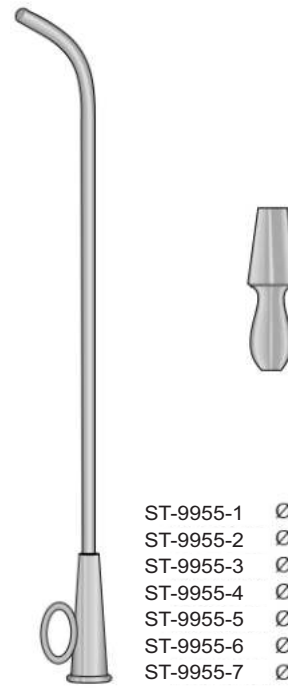
ST-9950
145 mm





- ST-9954-1 Ø 3,0 mm
- ST-9954-2 Ø 3,5 mm
- ST-9954-3 Ø 4,0 mm
- ST-9954-4 Ø 4,5 mm
- ST-9954-5 Ø 5,0 mm

ITARD
ST-9954
145 mm



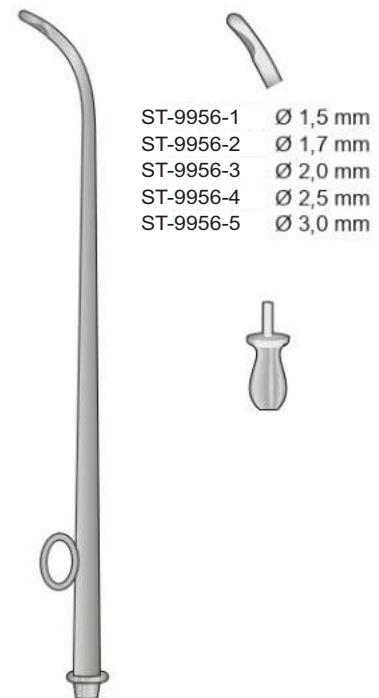
- ST-9955-1 Ø 2,0 mm
- ST-9955-2 Ø 2,5 mm
- ST-9955-3 Ø 3,0 mm
- ST-9955-4 Ø 3,5 mm
- ST-9955-5 Ø 4,0 mm
- ST-9955-6 Ø 4,5 mm
- ST-9955-7 Ø 5,0 mm

HARTMANN
ST-9955
150 mm



- ST-9955-1 Ø 1,5 mm
- ST-9955-2 Ø 1,7 mm
- ST-9955-3 Ø 2,0 mm
- ST-9955-4 Ø 2,5 mm
- ST-9955-5 Ø 3,0 mm

SIEBENMANN
ST-9955
150 mm

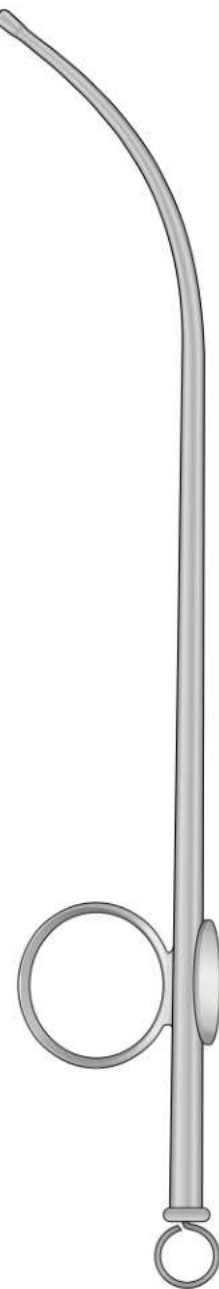
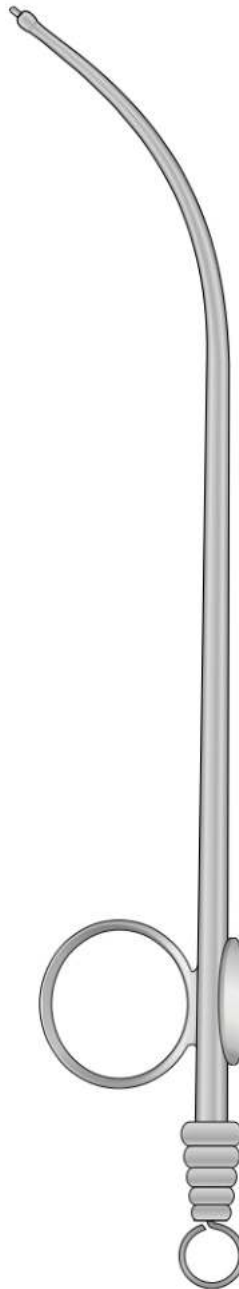
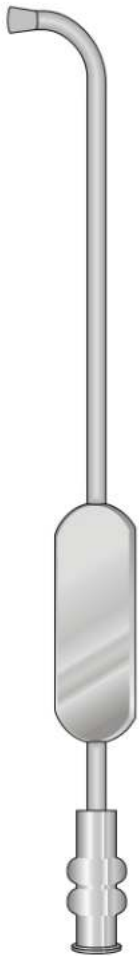


- ST-9956-1 Ø 1,5 mm
- ST-9956-2 Ø 1,7 mm
- ST-9956-3 Ø 2,0 mm
- ST-9956-4 Ø 2,5 mm
- ST-9956-5 Ø 3,0 mm

SIEBENMANN
ST-9956
150 mm

Ø Interno
Ø Inside
Ø Innen
Ø Intérieur
Ø Interior

Ø Interno
Ø Inside
Ø Innen
Ø Intérieur
Ø Interior



KILLIAN
ST-9957-1 Ø 3 mm
ST-9957-2 Ø 4 mm
145 mm
ST-9957

KILLIAN
ST-9957-3 Ø 3 mm
ST-9957-4 Ø 4 mm
145 mm

MAGILL
ST-9958-1 Ø 1 mm
200 mm
ST-9958

MAGILL
ST-9958-2 Ø 1 mm
ST-9958-3 Ø 2 mm
ST-9958-4 Ø 3 mm
200 mm



Steriliser bar
Autoclavable
Autoclavabile
Esterilizable
Stérilisable

Handwaschbürste
Nail brush
Spazzola per unghie
Cepillo de uñas
Brosse à ongles

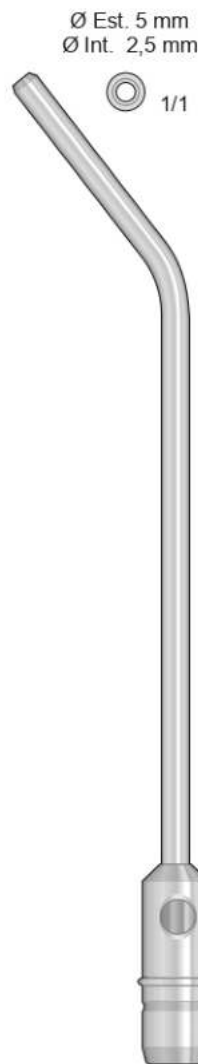
Scovolini per pulizia canule
Kanülenreinigungs-bürsten



ST-9962
4 x 11 cm



PELTON-CRANE
ST-9959
140 mm



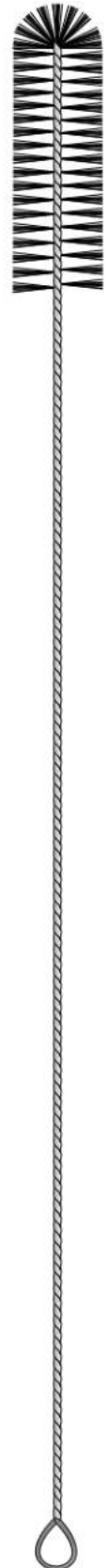
PELTON-CRANE
ST-9960
160 mm



ST-9961-1
120 mm

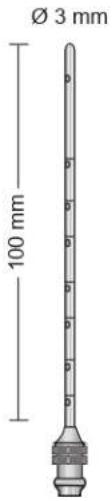


ST-9961-2
235 mm

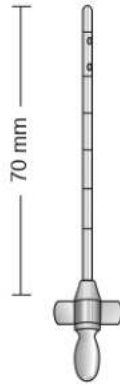


ST-9961-3
330 mm

Sonde per varici, malleabili - Probe for varicose veins, malleable
 Krampfadersonden, biegsam - Sondes pour varices, malléables
 Sondas para vârices, maleables



ST-9963
FRAZIER



ST-9963-1 - Ø 2 mm
 ST-9963-2 - Ø 2,5 mm



BABCOCK

ST-9964-1 - 400 mm
 ST-9964-2 - 500 mm
 ST-9964-3 - 650 mm
 ST-9964-4 - 800 mm

Aghi per tonsille
 Tonsil needles
 Tonsillenkantülen
 Aiguilles pour les amygdales
 Agujas para amigdalas



ST-9965
120 mm



ST-9966
110 mm



ST-9967
110 mm



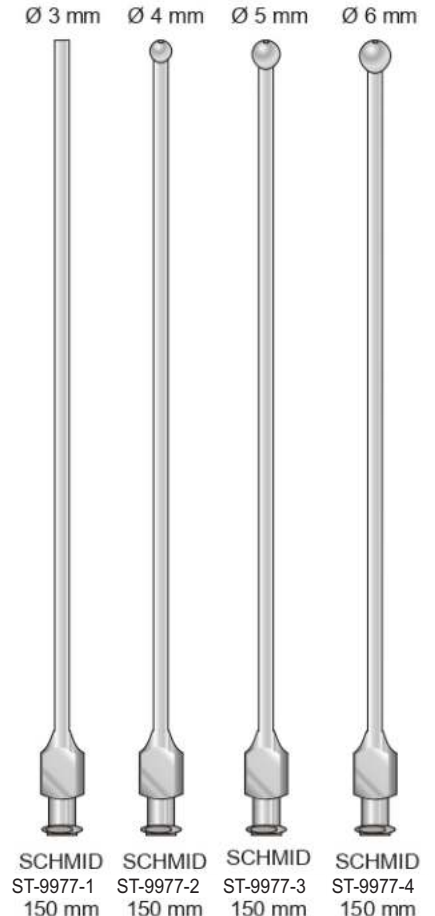
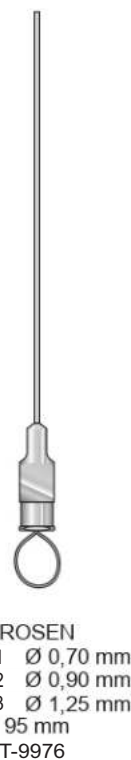
SEPTUN-NADEL
ST-9968
110 mm

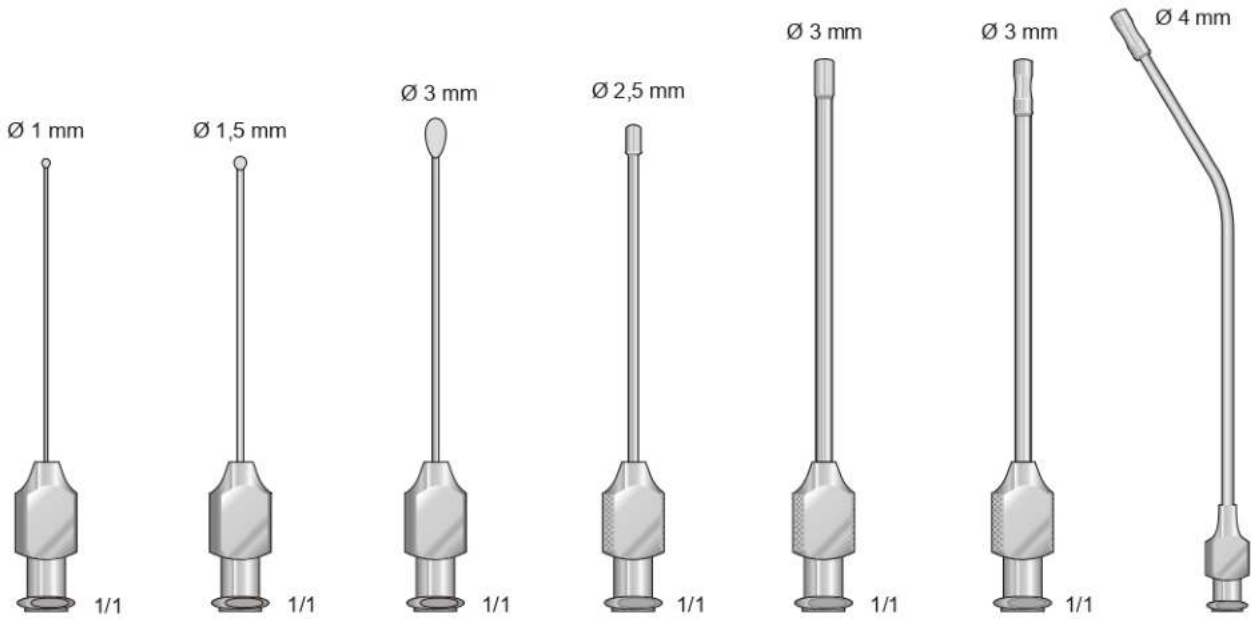


ST-9969
110 mm

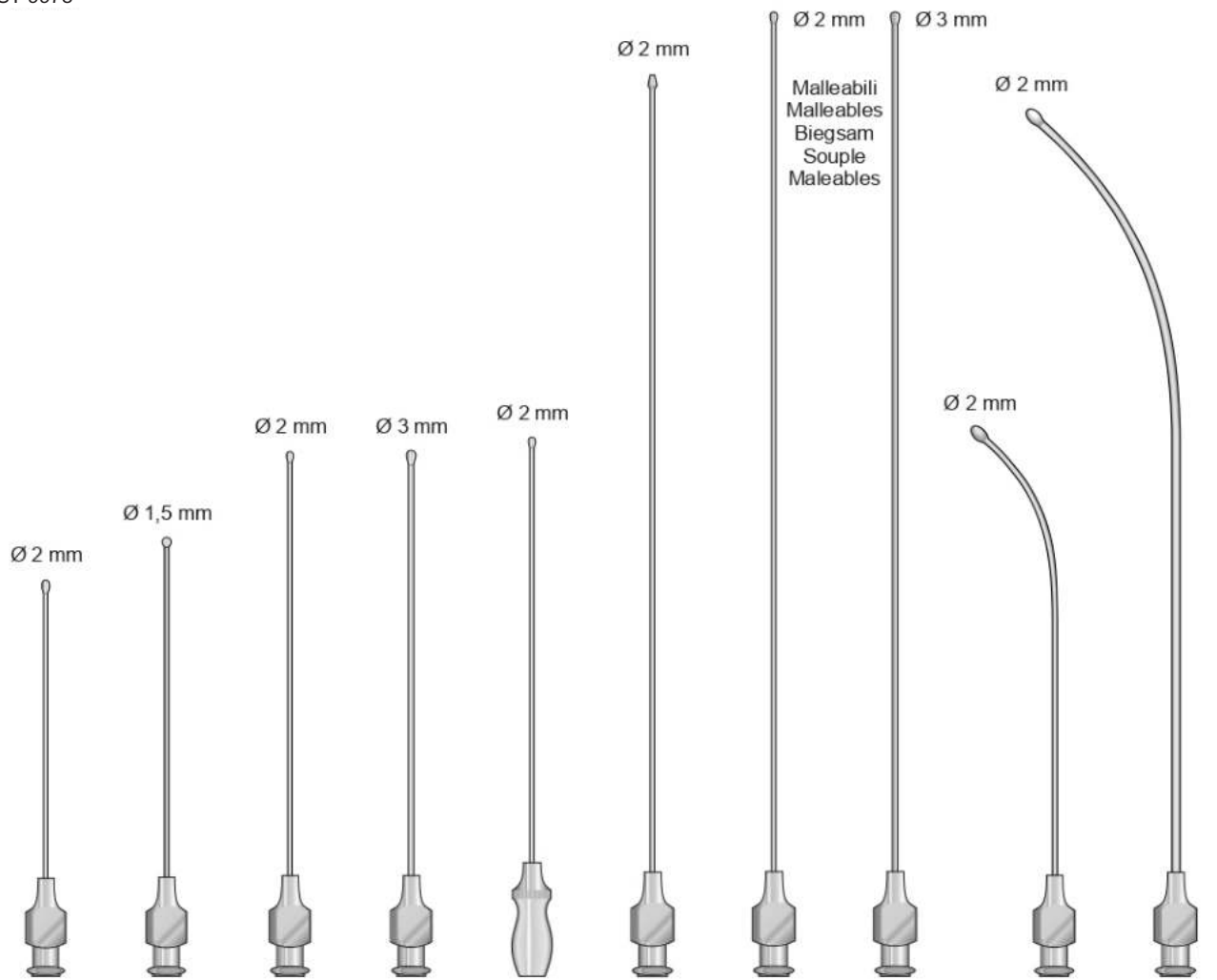


Canule per irrigazione dei vasi, malleabili
Vessel irrigating cannulas, malleable
Gefäß-spülkanülen, biegsam
Canules d'irrigation pour vaisseaux, malléables
Cánulas de irrigacion para vasos, maleables



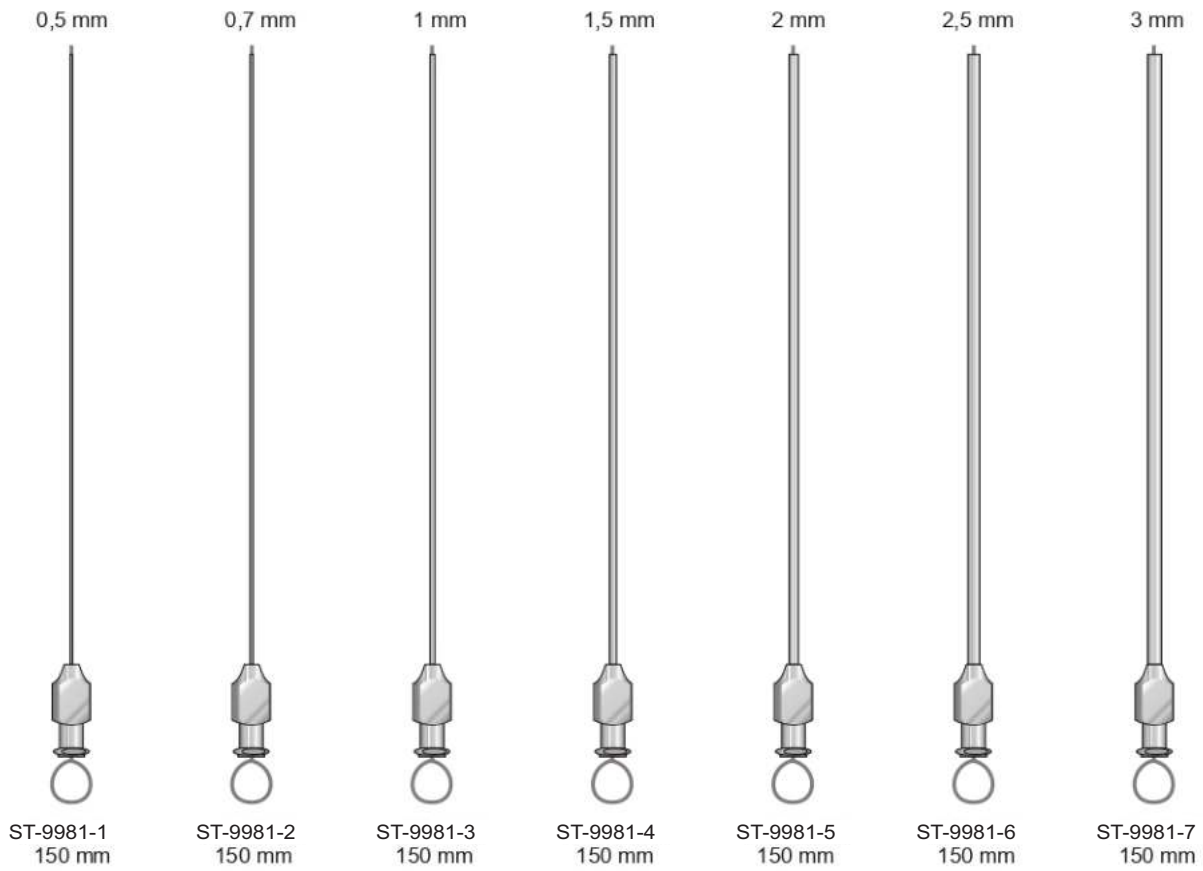


HEPARIN		HEPARIN		HEPARIN				
ST-9978-1	60 mm	ST-9978-3	60 mm	ST-9979-1	65 mm	ST-9979-2	65 mm	ST-9979-3
ST-9978-2	80 mm	ST-9978-4	80 mm					75 mm
ST-9978								ST-9979-4
								75 mm
								ST-9979-5
								95 mm

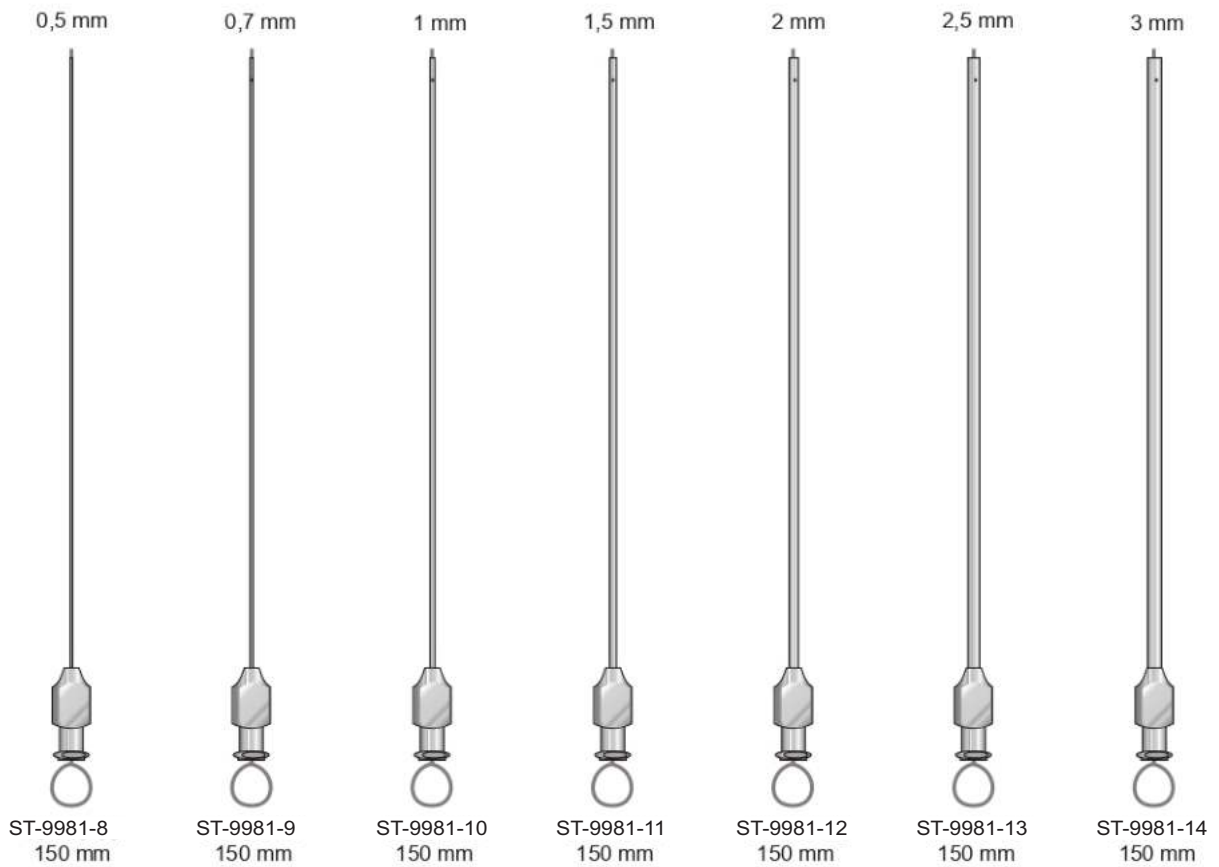


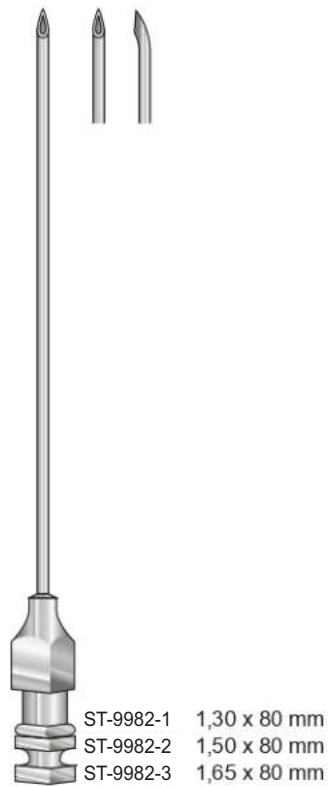
ST-9980-1	ST-9980-2	ST-9980-3	ST-9980-4	ST-9980-5	ST-9980-6	ST-9980-7	ST-9980-8	ST-9980-9	ST-9980-10
75 mm	80 mm	95 mm	95 mm	100 mm	150 mm	170 mm	170 mm	90 mm	140 mm

Aghi malleabili



Aghi malleabili con due fori

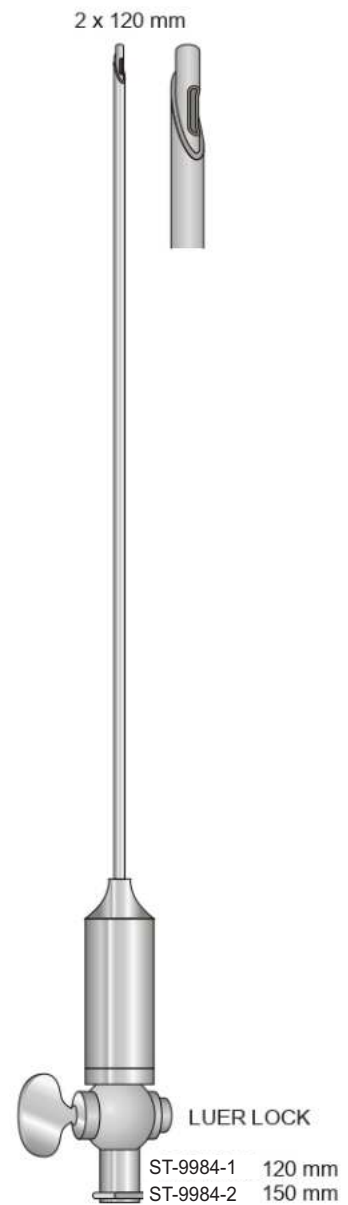




TUOHY
ST-9982



QUINCKE
ST-9983



VERRES
ST-9984



SAFE TOOL
MANUFACTURER & EXPORTER



Maintenance & Sterilization



www.safetool.com.pk

***Surgical
Instruments***

Scatola per sterilizzazione aghi da sutura - Box for needles
Sterilbehälter für Nadeln - Boite pour aiguilles de suture
Estuche para agujas

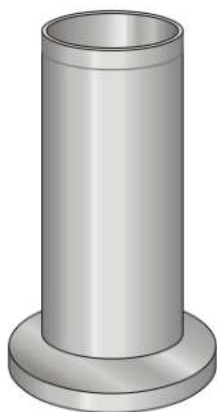


ST-7801
Ø 78 mm h 15 mm

Vaso in vetro con coperchio in acciaio inox
Jarin glass with lid in stainless steel
Pot en verre avec couvercle en acier inox



ST-7802-1 Ø 100x100 mm
ST-7802-2 Ø 120x120 mm



ST-7803-1 Ø 50 mm h 100 mm
ST-7803-2 Ø 50 mm h 150 mm
ST-7803-3 Ø 80 mm h 180 mm

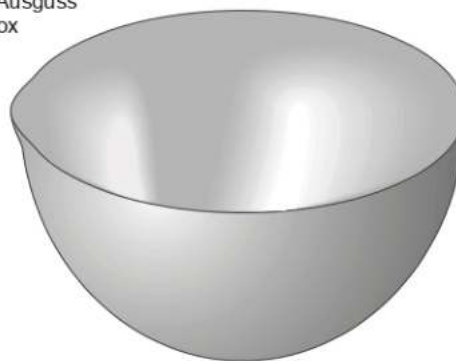


ST-7804-1 Ø 100x100 mm
ST-7804-2 Ø 120x120 mm

Capsule inox con fondo piano e becco
Lotion bowis capsules
Runder Sterilbehälter mit Ausguss
Capsule en acier inox



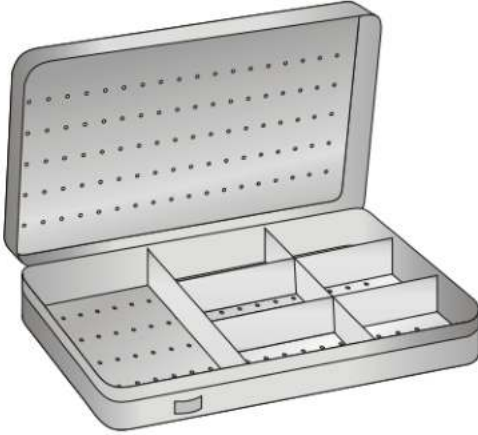
ST-7805-1 Ø 40 mm 15 cc
ST-7805-2 Ø 60 mm 75 cc
ST-7805-3 Ø 80 mm 225 cc
ST-7805-4 Ø 100 mm 325 cc
ST-7805-5 Ø 120 mm 500 cc
ST-7805-6 Ø 150 mm 600 cc



ST-7806-1 Ø 180 mm 1000 cc
ST-7806-2 Ø 200 mm 1450 cc
ST-7806-3 Ø 220 mm 2000 cc
ST-7806-4 Ø 240 mm 3300 cc

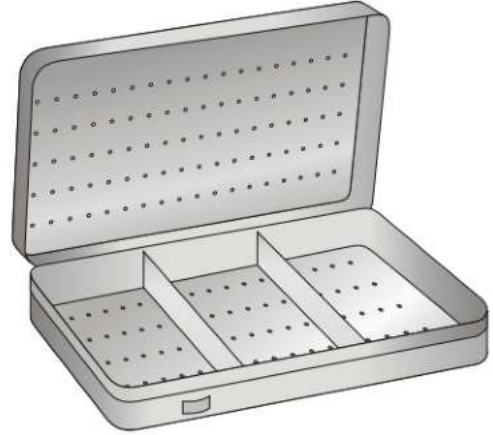
Inox - Stainless steel - Rostfrei
Inoxidable

Bacinella a 7 scomparti



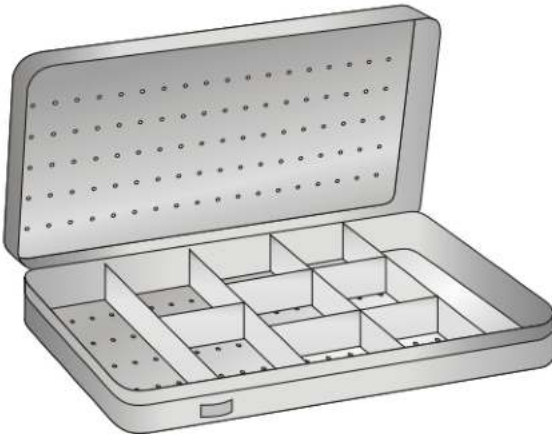
ST-7807
150 x 90 x 20 mm

Bacinella a 3 scomparti

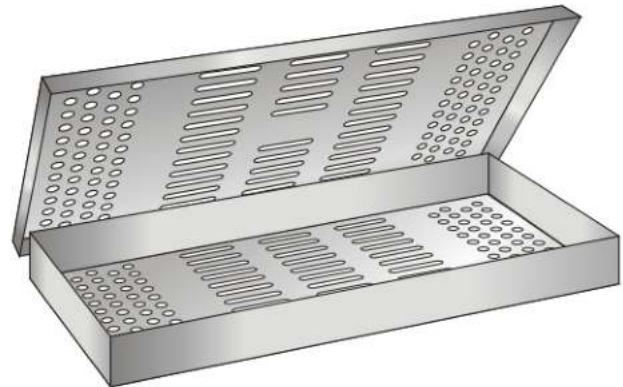


ST-7808
150 x 90 x 20 mm

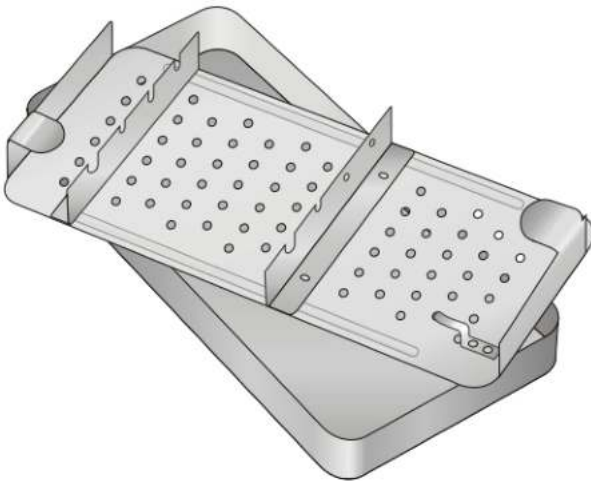
Bacinella a 10 scomparti



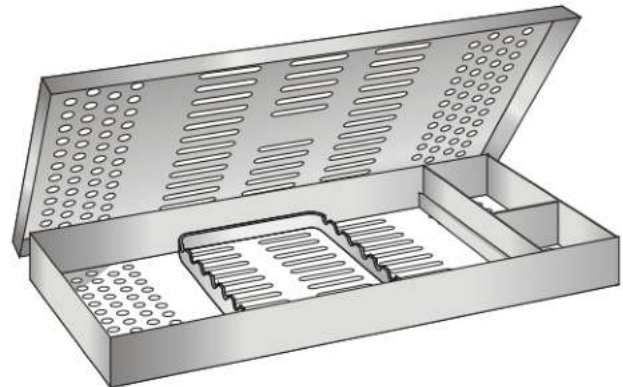
ST-7809
220 x 120 x 20 mm



ST-7810
275 x 130 x 25 mm



ST-7811
180 x 90 x 35 mm 2 ripiani



ST-7812-1 275 x 130 x 25 mm Con griglia e scomparti
ST-7812-2 285 x 190 x 25 mm Con griglia e scomparti

Bacinelle reniformi
Kidney bowls
Nierenschalen
Bassins réniformes
Riñoneras



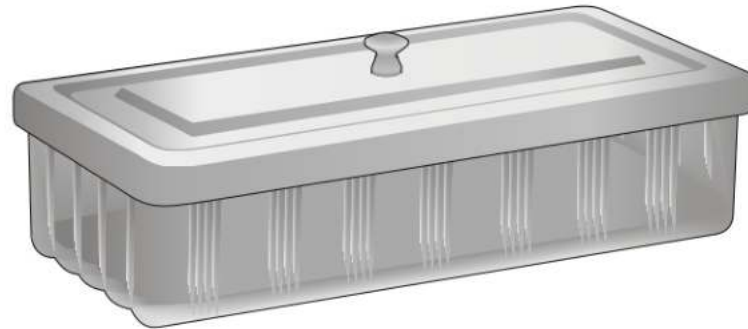
ST-7813-1 200 mm
ST-7813-2 250 mm
ST-7813-3 280 mm

Vassoi porta-strumenti
Trays
Schalen
Bassins
Bandejas



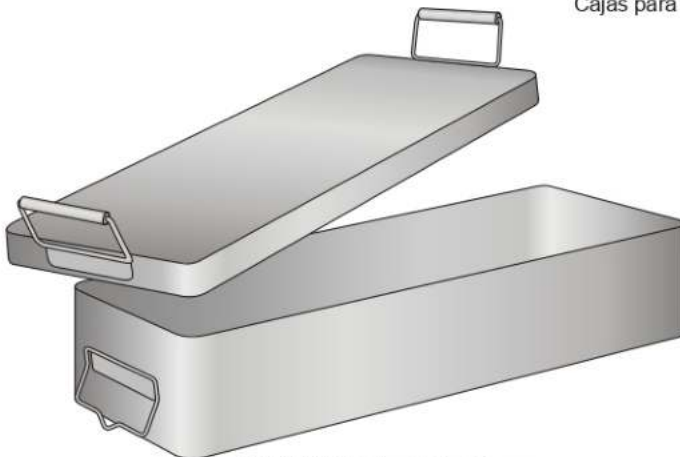
ST-7814-1 210x150x25 mm
ST-7814-2 250x180x30 mm
ST-7814-3 300x220x30 mm

Bacinella in vetro con coperchio e pomolo in acciaio inox
Container in glass with lid and knob in stainless steel
Cuvette en verre avec couvercle et pommeau en acier inox



ST-7815-1 140x80x50 mm
ST-7815-2 200x60x40 mm
ST-7815-3 220x100x50 mm
ST-7815-3 220x140x60 mm
ST-7815-3 300x180x65 mm

Scatole per sterilizzazione a secco
Instrument boxes
Instrumentenkästen
Boites pour instruments
Cajas para instrumentos



ST-7816-1 280 x 140 x 60 mm
ST-7816-2 300 x 140 x 60 mm
ST-7816-3 360 x 160 x 70 mm



ST-7817-1 150 x 90 x 40 mm
ST-7817-2 200 x 100 x 60 mm
ST-7817-3 250 x 120 x 60 mm
ST-7817-4 280 x 140 x 60 mm
ST-7817-5 320 x 150 x 60 mm



Cestelli rettangolari con filtro
Mit filter
Whith filter
Avec filtre
Con filtros



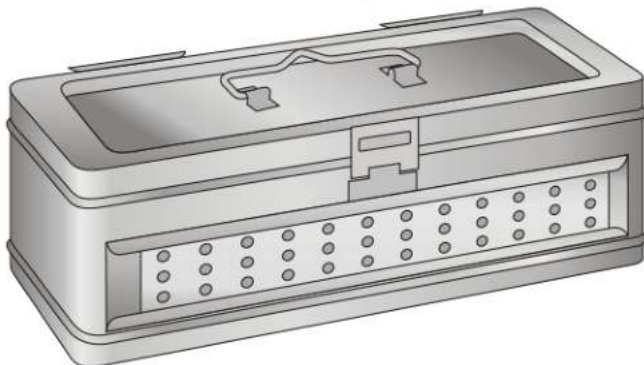
- ST-7818-1 200 x 180 x 120 mm
- ST-7818-2 200 x 180 x 180 mm
- ST-7818-3 250 x 250 x 250 mm
- ST-7818-4 270 x 160 x 160 mm
- ST-7818-5 290 x 290 x 290 mm
- ST-7818-6 350 x 230 x 200 mm

Cestelli cilindrici
Dressing sterilizing drums
Verbandstofftrommeln
Boites à stérilisation
Cajas para esterilizacion



- ST-7819-1 125x125 mm
- ST-7819-2 150x150 mm
- ST-7819-3 190x145 mm
- ST-7819-4 290x240 mm

Cestelli rettangolari
Rectengular drum
Panier rectangulaire



- ST-7820-1 300 x 150 x 60 mm
- ST-7820-2 300 x 150 x 90 mm
- ST-7820-3 300 x 150 x 180 mm

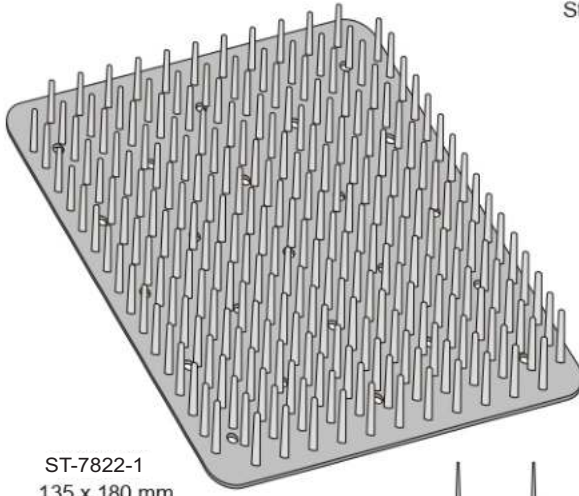
Cestelli rettangolari
Rectengular drum
Panier rectangulaire



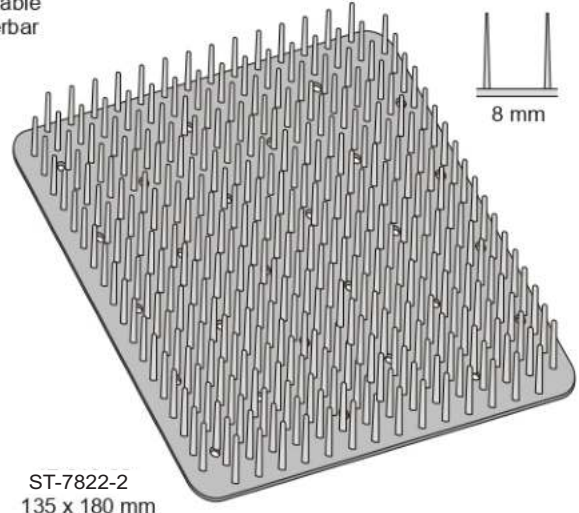
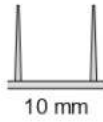
- ST-7821-1 190x110x120 mm
- ST-7821-2 200x180x120 mm
- ST-7821-3 200x180x180 mm
- ST-7821-4 250x200x200 mm



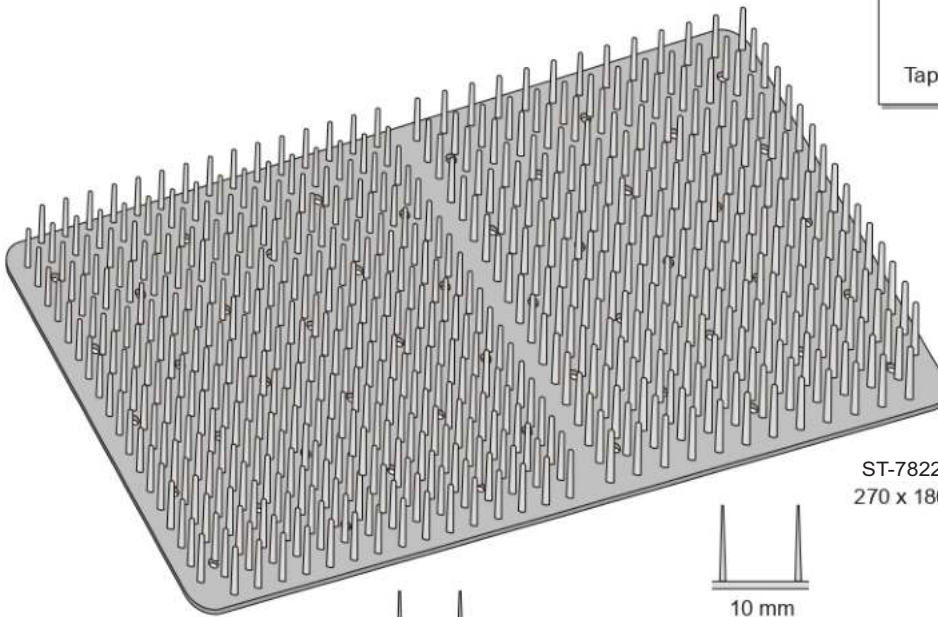
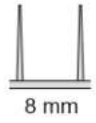
Autoclavabili
Autoclavable
Sterilisierbar



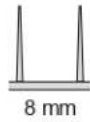
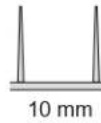
ST-7822-1
135 x 180 mm



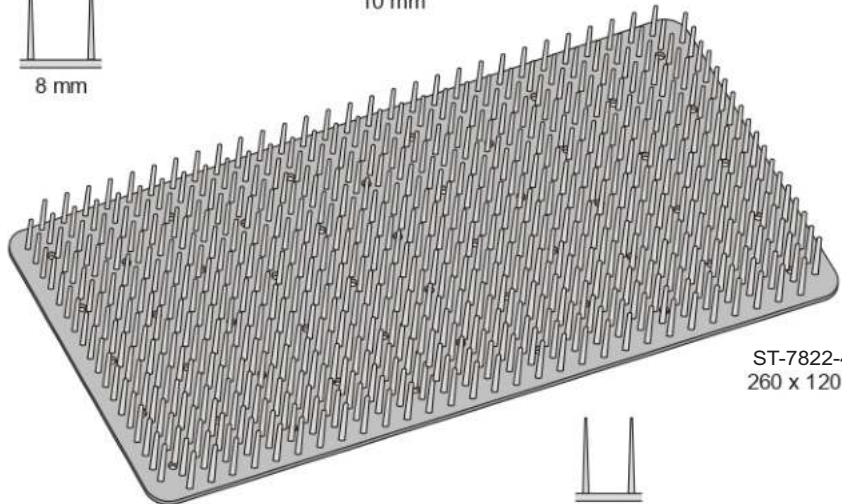
ST-7822-2
135 x 180 mm



ST-7822-3
270 x 180 mm



8 mm



ST-7822-4
260 x 120 mm



6 mm

Tappeti in aghi di silicone
Silikon matte
Matte en silicone
Tapis en Silicone
Tapete en agujas de silicona



Pinze per prelevare strumenti sterilizzati
Pinzette zum Entnehmen Sterilisierter Instrumente



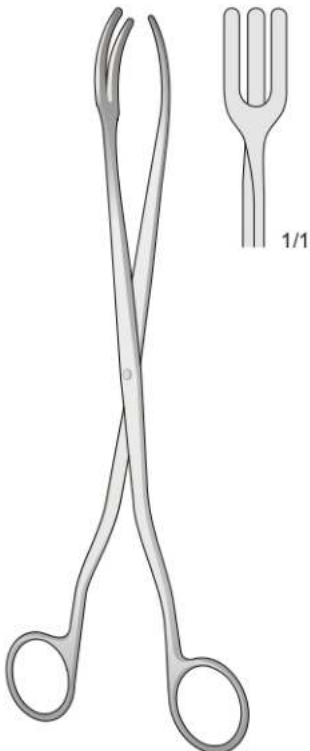
ST-7823
145 mm



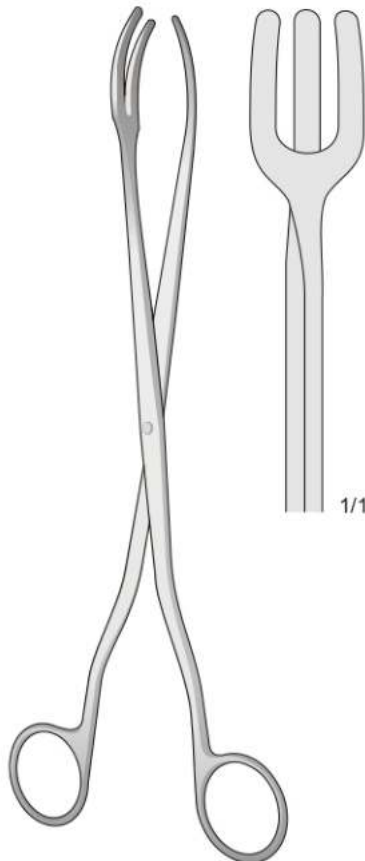
DAVIS
ST-7824
160 mm



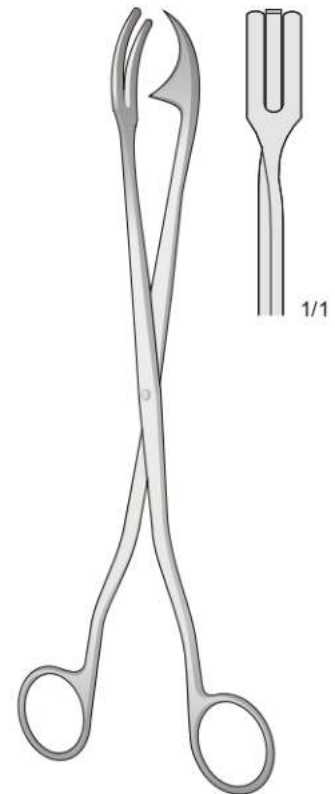
DAVIS
ST-7825
200 mm



ST-7826
200 mm



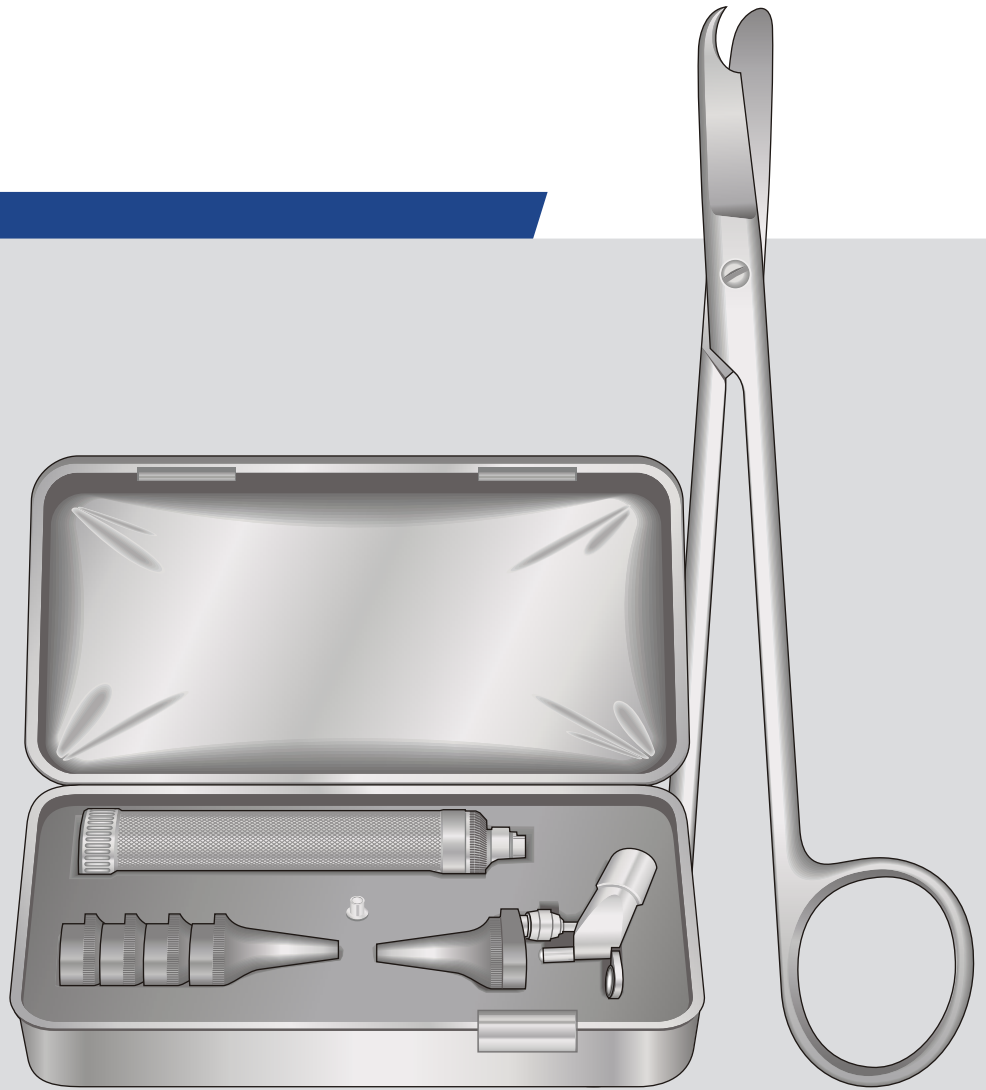
ST-7827
300 mm



ROGGE
ST-7828
230 mm



SAFE TOOL
MANUFACTURER & EXPORTER



General Surgery Instruments



www.safetool.com.pk

***Surgical
Instruments***

Diagnostik-Bestecke - Diagnostic Sets
Set Diagnostica - Set Diagnóstico
Troussets à Diagnostic

Etui für McINTOSH Fig. 1-3
Case for McINTOSH Fig. 1-3
Cassetta per laringoscopio McINTOSH Fig. 1-3
Estuche para McINTOSH Fig. 1-3
Etui pour McINTOSH Fig. 1-3

Halogen - Alogeno



ST-4301

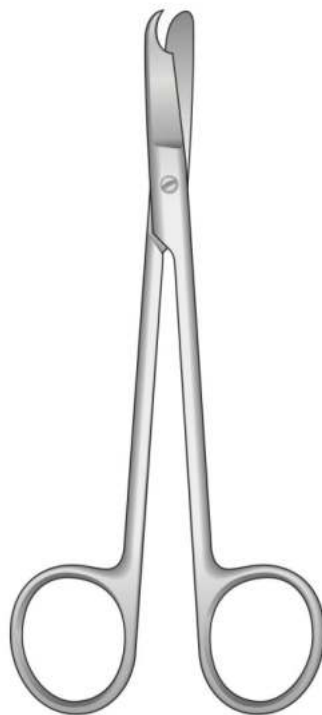
Otoscopio completo con custodia



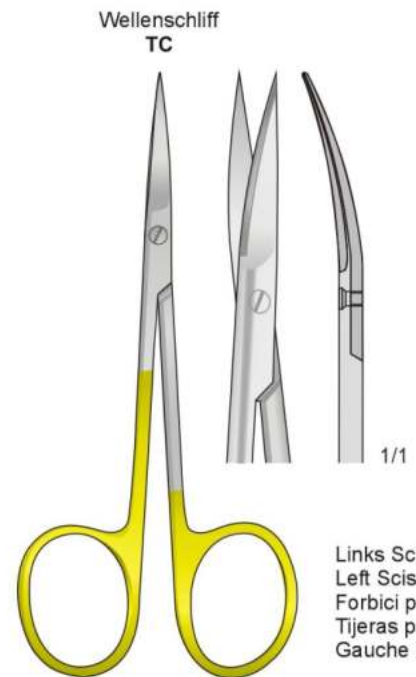
ST-4302



SPENCER
ST-4303
120 mm



LITTAUER
ST-4304
140 mm



Wellenschliff
TC

1/1

IRIS
ST-4305
110 mm

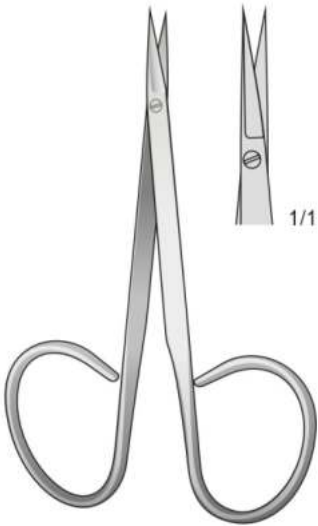
Links Scheren
Left Scissors
Forbici per mancini
Tijeras para zurdos
Gauche Ciseaux

"Ribbon type"

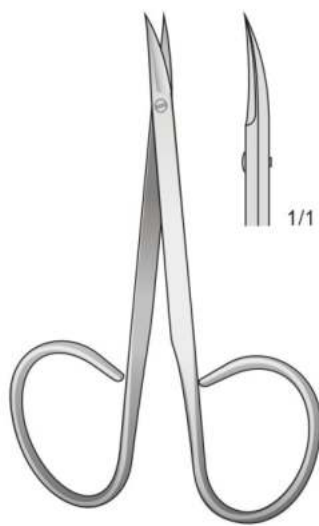
Mit großen Ringen
With large rings
Forbici ad anelli grandi
Con anillos especialmente grandes
avec larges anneaux

Iris scissors

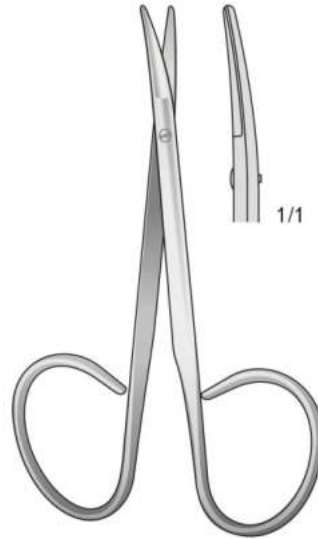
Blepharoplasty
Blefaroplastica



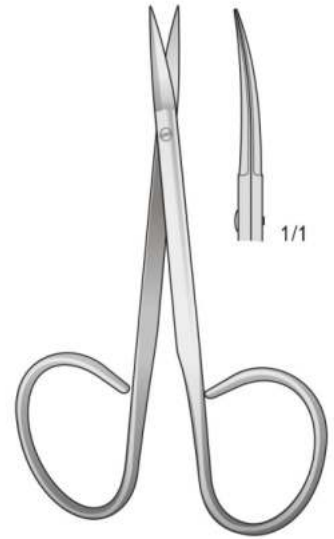
ST-4306
95 mm



ST-4307
95 mm

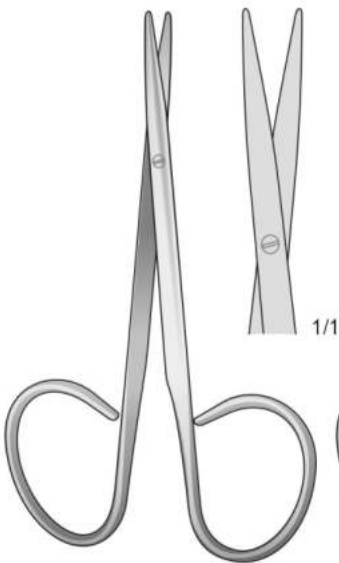


ST-4308
95 mm

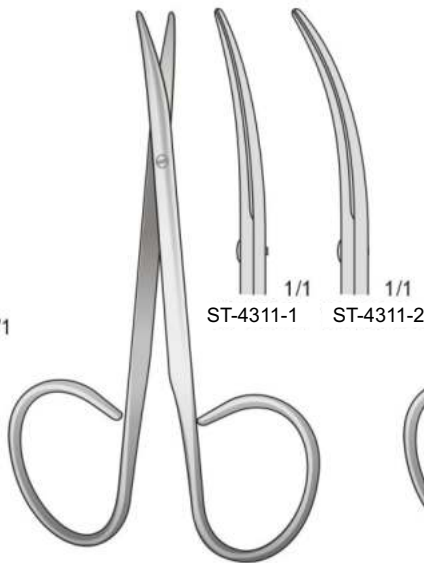


ST-4309
105 mm

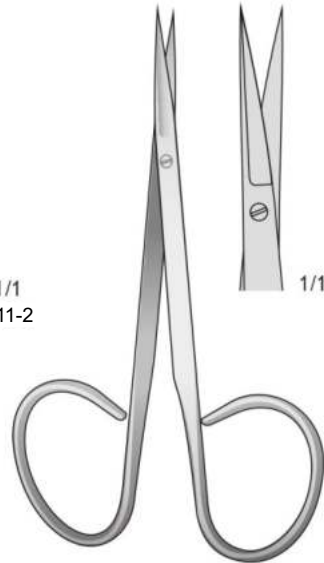
Iris scissors



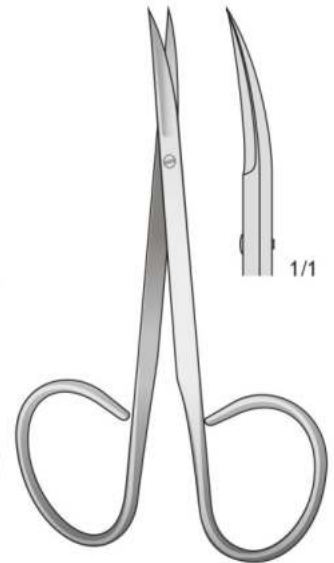
ST-4310
100 mm



ST-4311
100 mm



ST-4312
105 mm

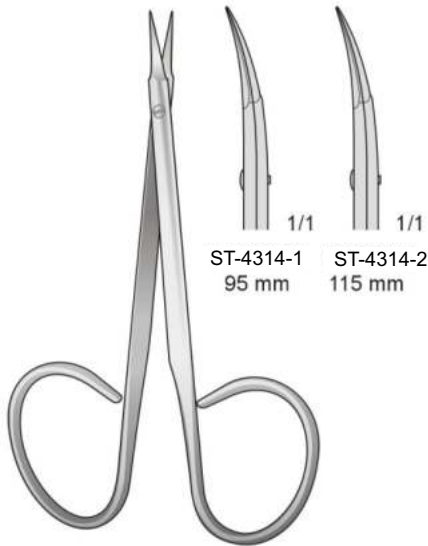


ST-4313
105 mm

"Ribbon type"

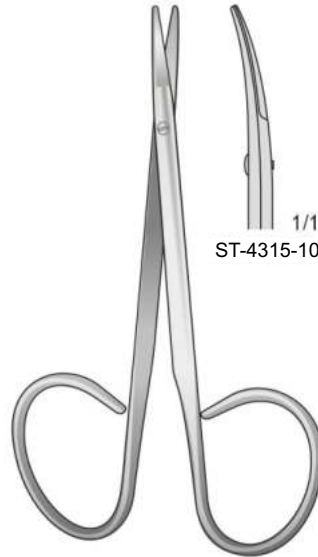
Mit großen Ringen
With large rings
Forbici ad anelli grandi
Con anillos especialmente grandes
avec larges anneaux

Spitz
Sharp
Acuta
Aguda
Pointu



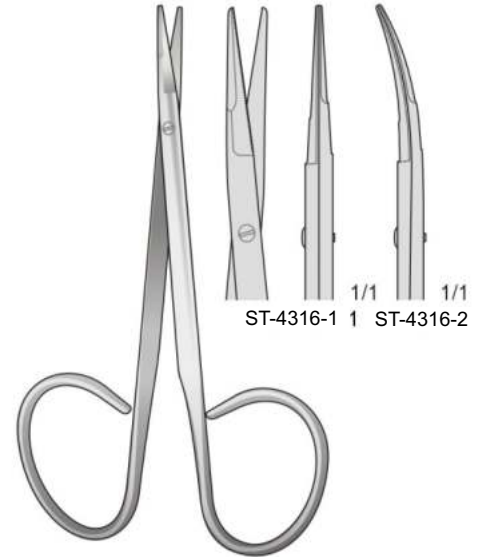
ST-4314
STITCH

Stumpf
Blunt
Smussa
Romas
Mousse



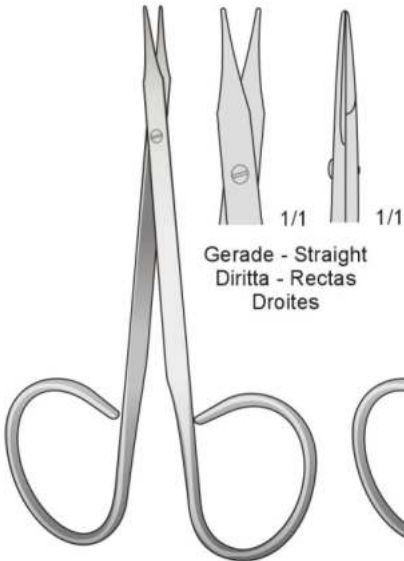
ST-4315
100 mm

Gezahnt
Serrated
Dentellata
Dentadas
Dentelés



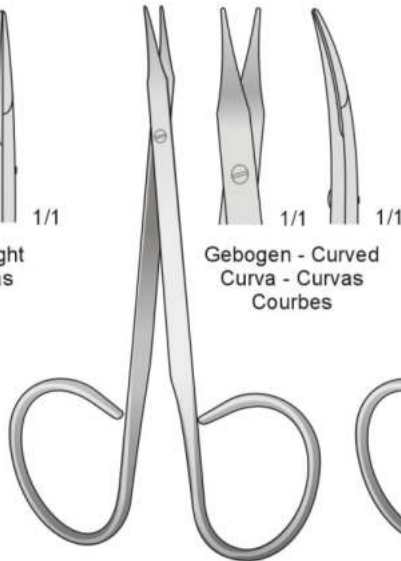
KAYE
ST-4316
105 mm

Stumpf - Blunt
Smussa - Romas
Mousse



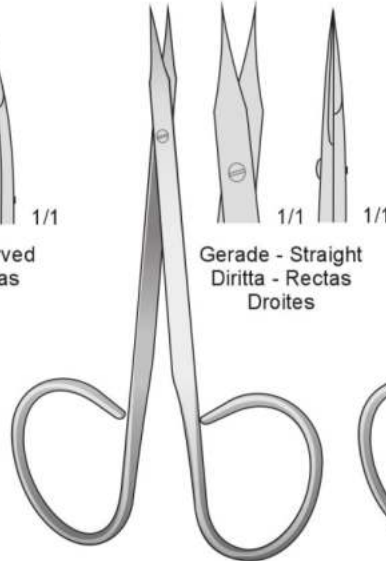
STEVENS
ST-4317
100 mm

Stumpf - Blunt
Smussa - Romas
Mousse



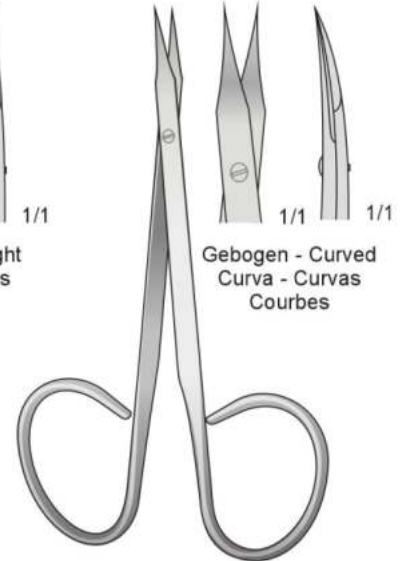
STEVENS
ST-4318
100 mm

Spitz - Sharp
Acuta - Aguda
Pointu



WALTON
ST-4319
100 mm

Spitz - Sharp
Acuta - Aguda
Pointu



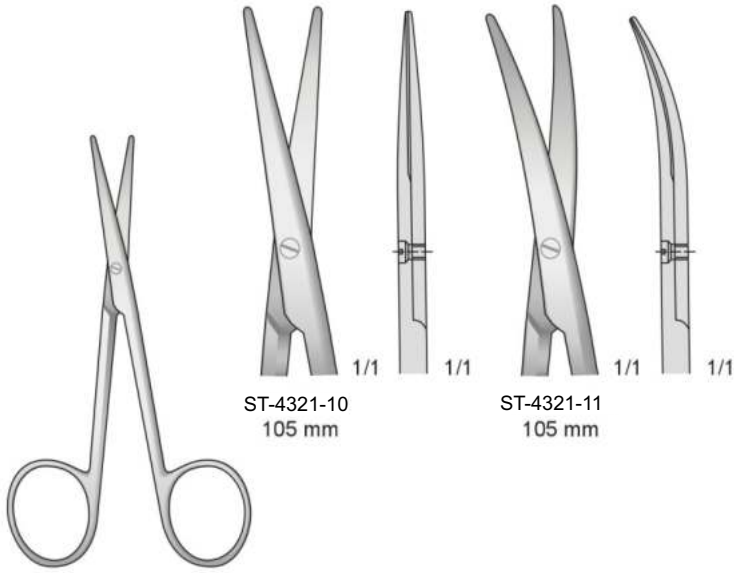
WALTON
ST-4320
100 mm

Gerade - Straight
Diritta - Rectas
Droites

Gebogen - Curved
Curva - Curvas
Courbes

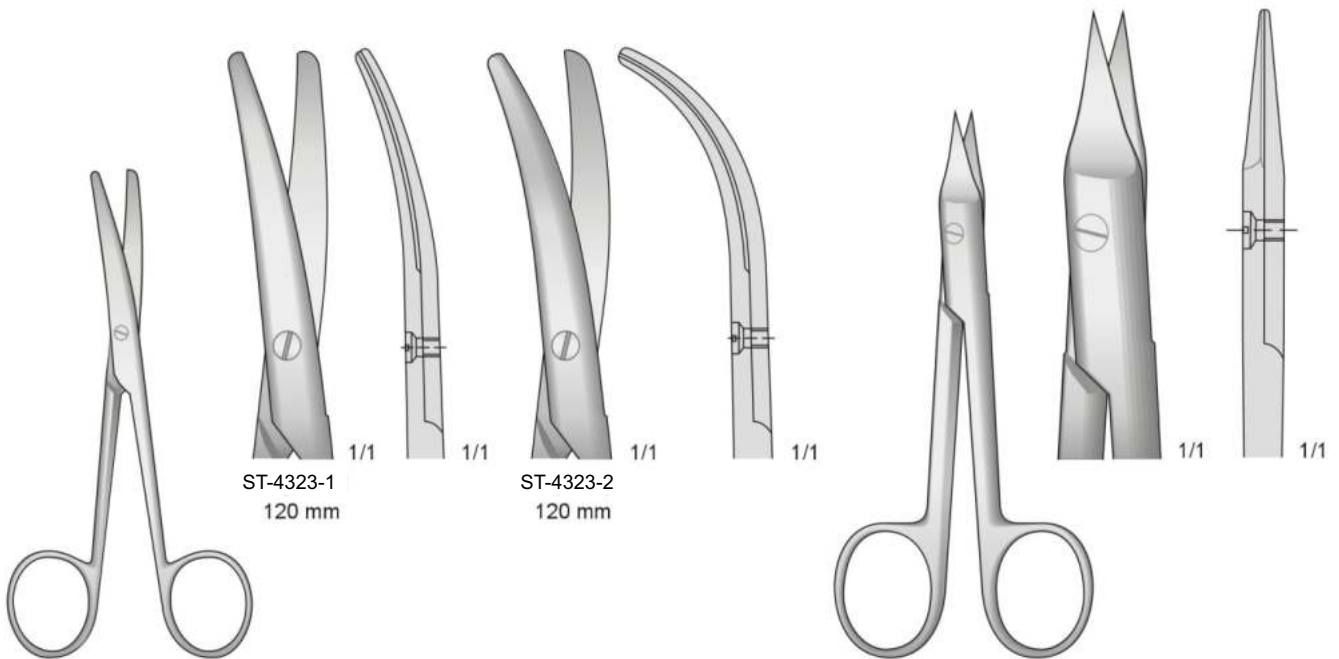
Gerade - Straight
Diritta - Rectas
Droites

Gebogen - Curved
Curva - Curvas
Courbes



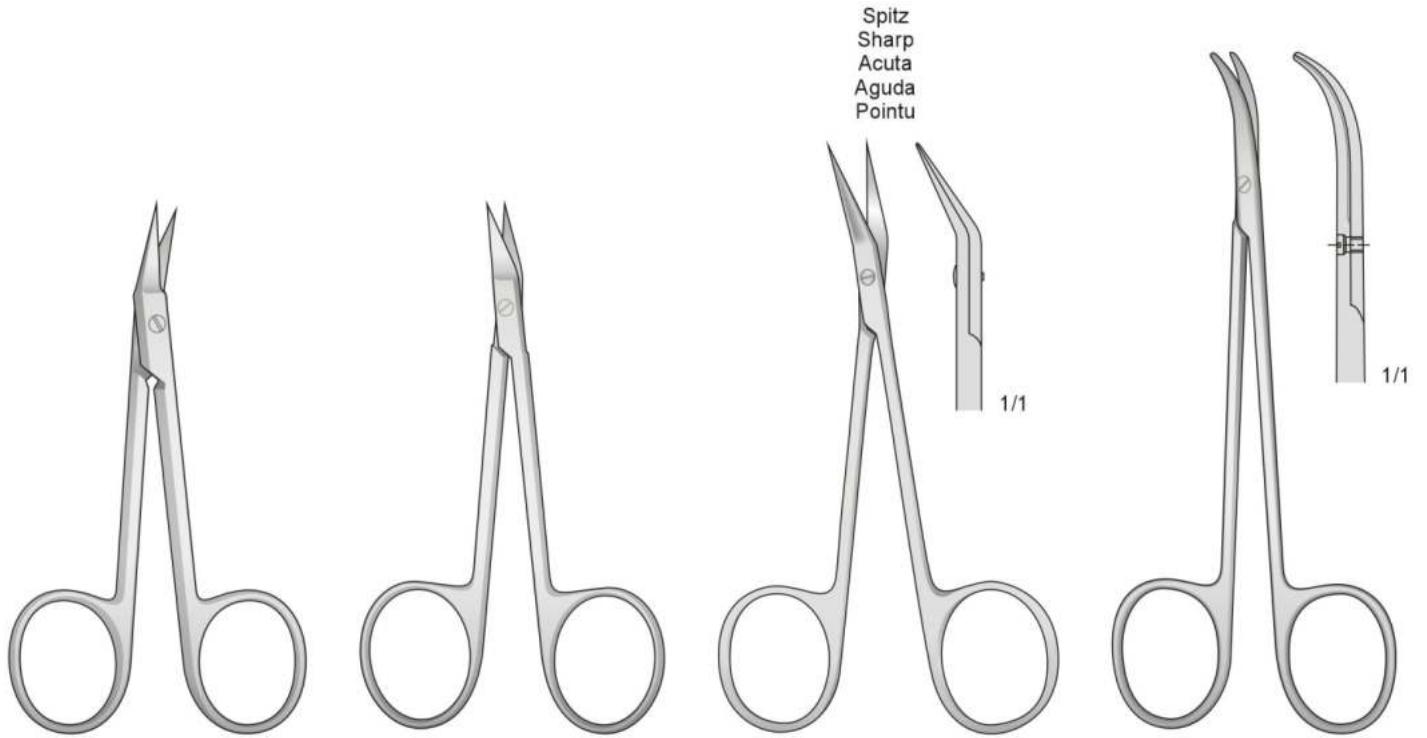
COTTLE-KNAPP
ST-4321
105 mm

COTTLE
ST-4322
115 mm



LANDOLT
ST-4323
120 mm

SYSTRUNK
ST-4324
130 mm

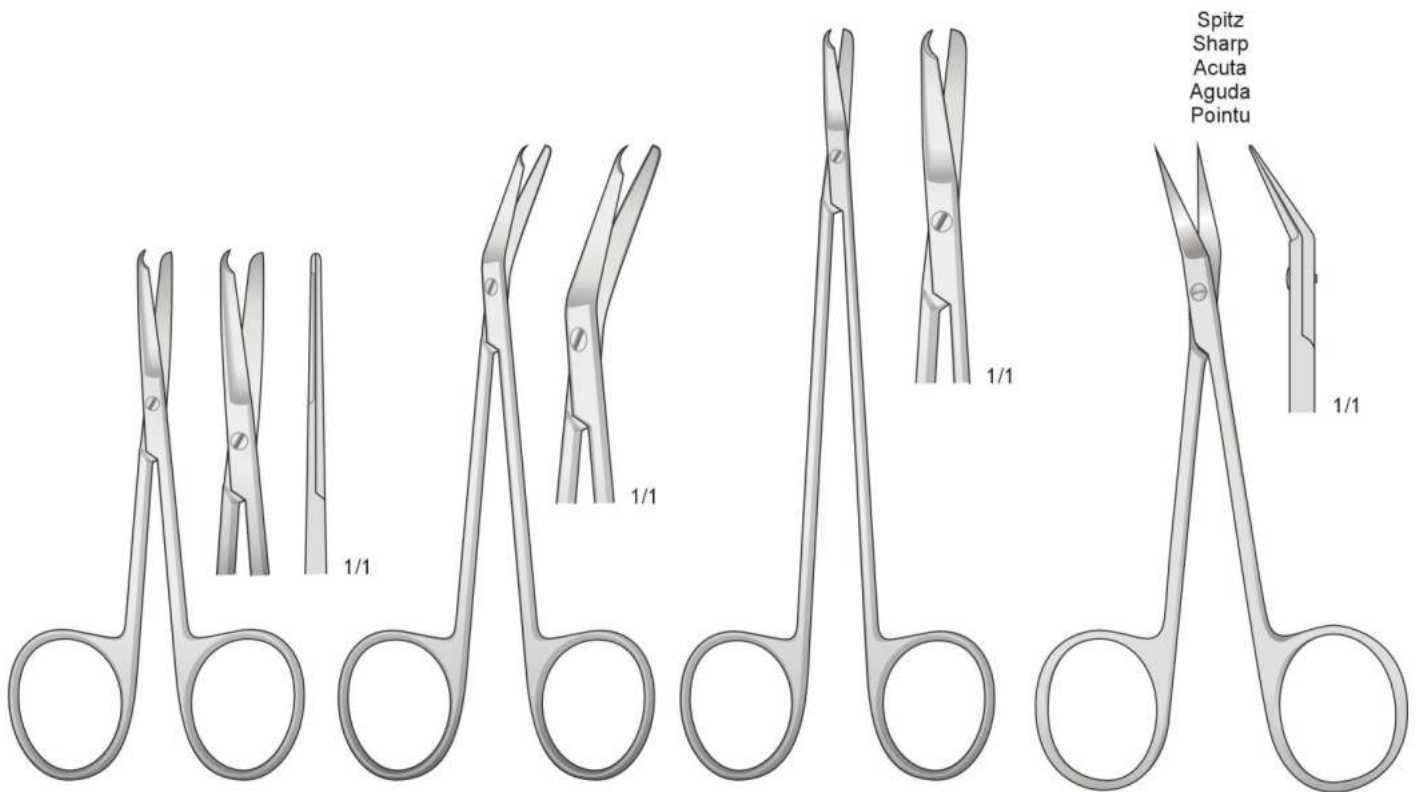


O'BRIEN
ST-4325
95 mm

DANIELS
ST-4326
90 mm

BIRO
ST-4327
100 mm

CINELLI
ST-4328
115 mm

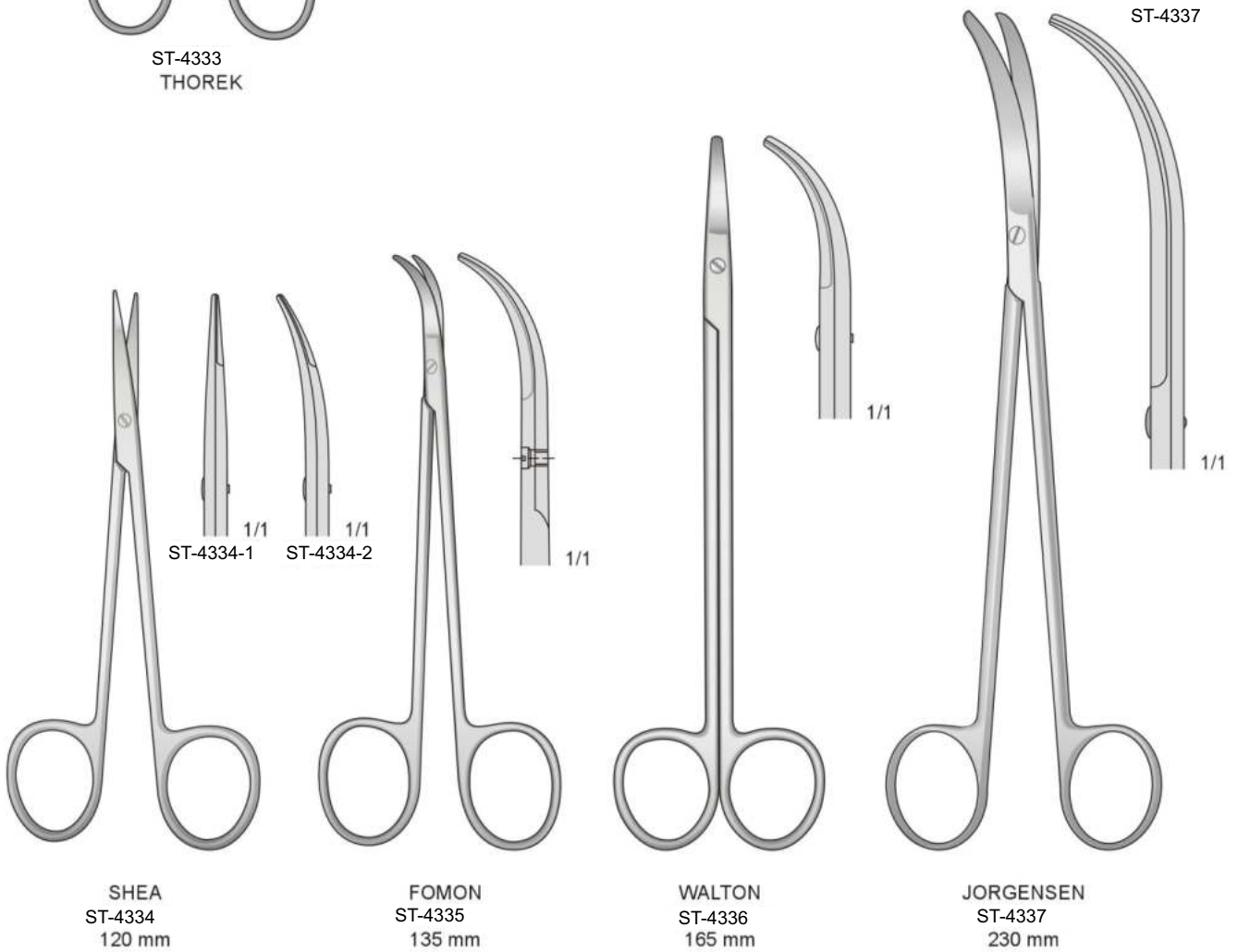


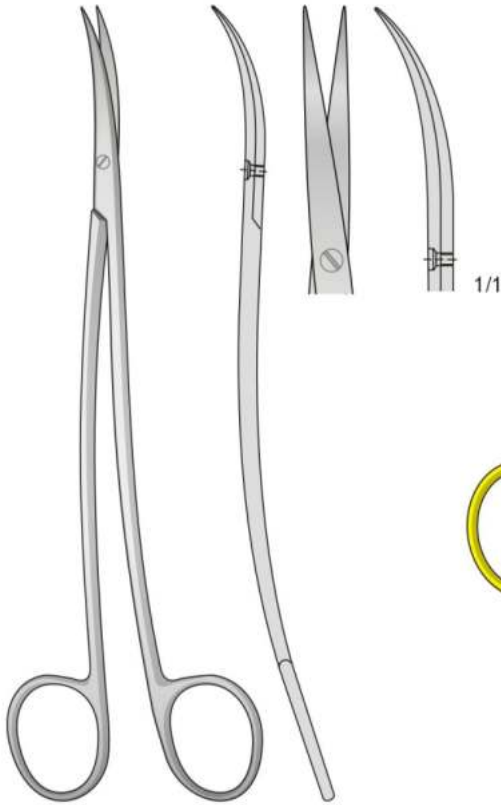
SPENCER
ST-4329
90 mm

SPENCER
ST-4330
130 mm

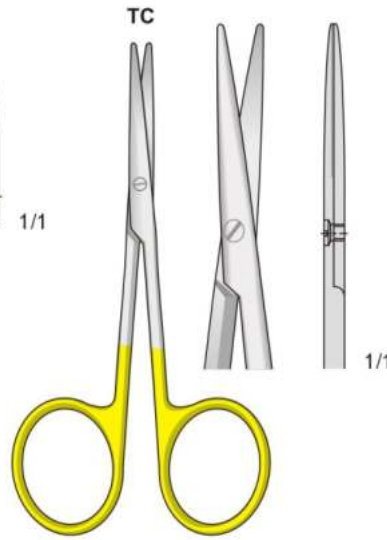
KELLY
ST-4331
150 mm

WILMER
ST-4332
105 mm

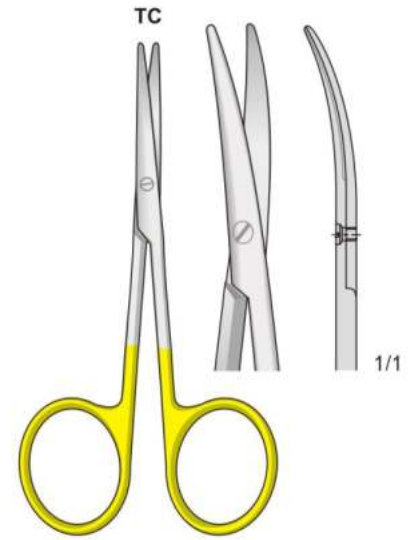




METZENBAUM-FINO
ST-4338-1 - 180 mm
ST-4339-2 - 200 mm
ST-4340-3 - 230 mm

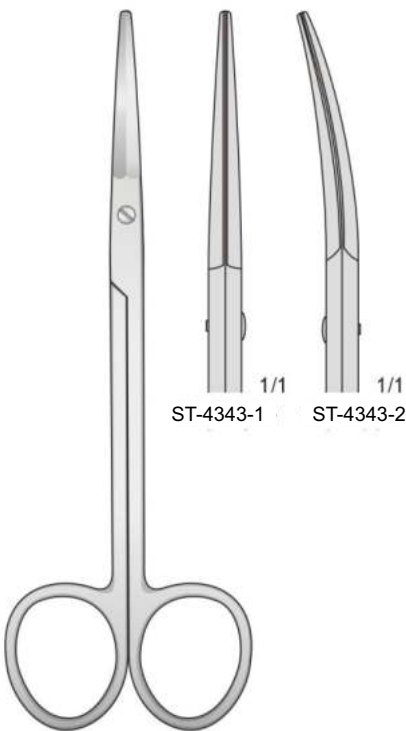


LEXER-BABY
ST-4341
100 mm



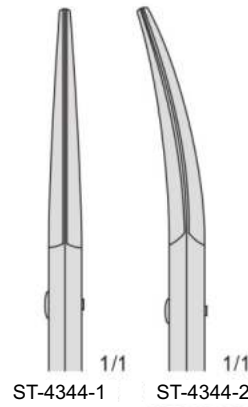
LEXER-BABY
ST-4342
100 mm

Gezahnt - Sawedge
Dentellate - Dentadas
Dentelés



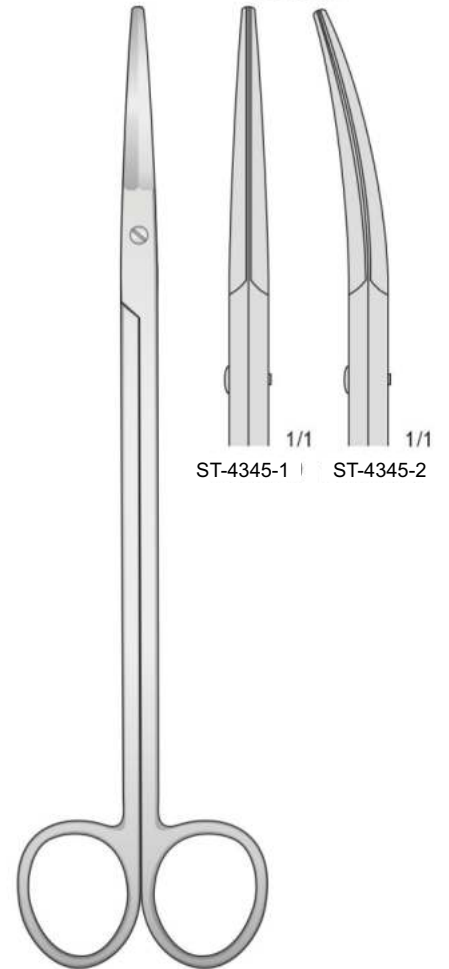
KAHN
ST-4343
145 mm

Gezahnt - Sawedge
Dentellate - Dentadas
Dentelés



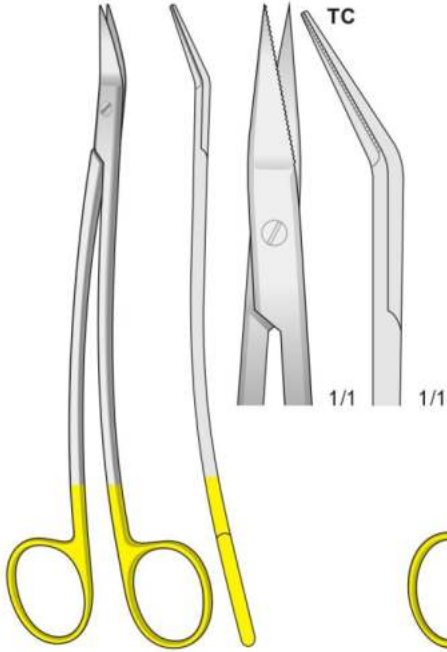
KAHN
ST-4344
180 mm

Gezahnt - Sawedge
Dentellate - Dentadas
Dentelés

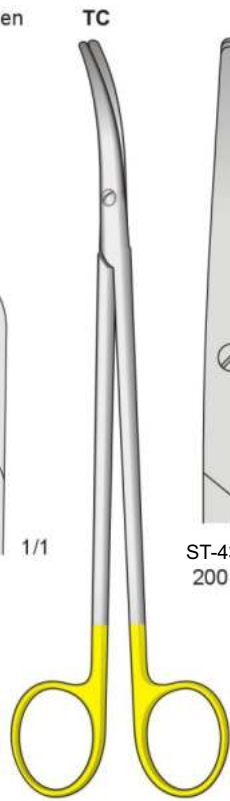


KAHN
ST-4345
205 mm

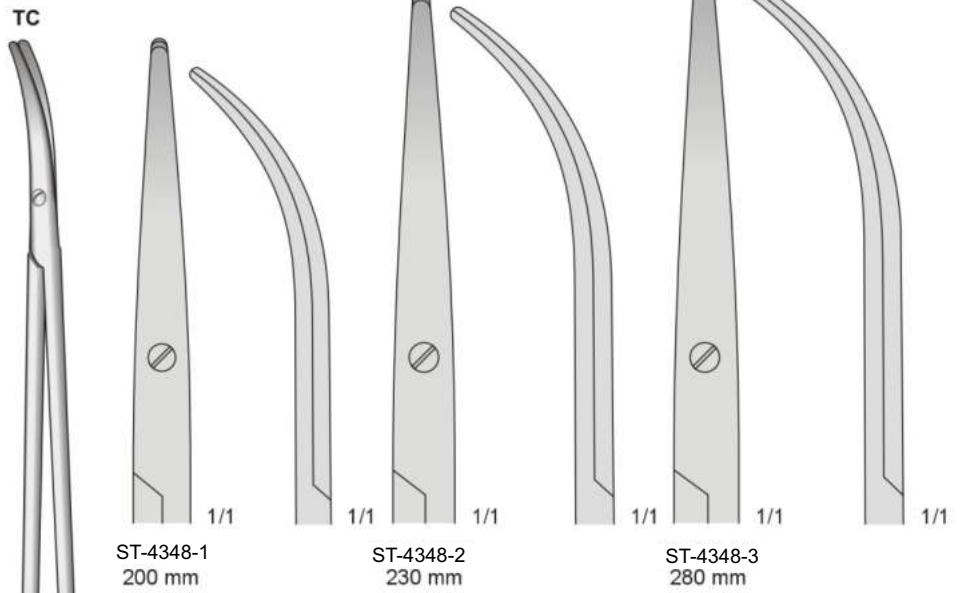
Eine Schneide gezahnt S-förmig gebogen
One toothed cutting edge S-shaped
Una lama dentata curva a forma S
Una hoja dentada forma S
Une lame dentelée courbés en S



ST-4346
175 mm



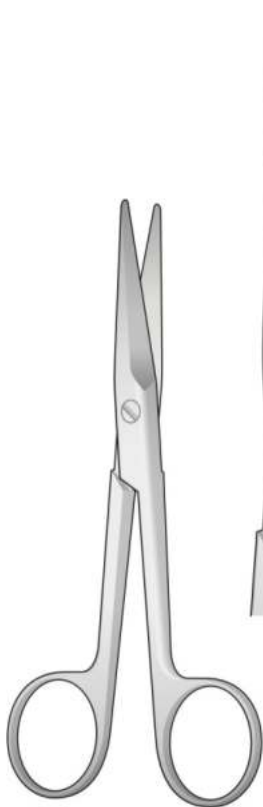
METZENBAUM-THOREK
ST-4347



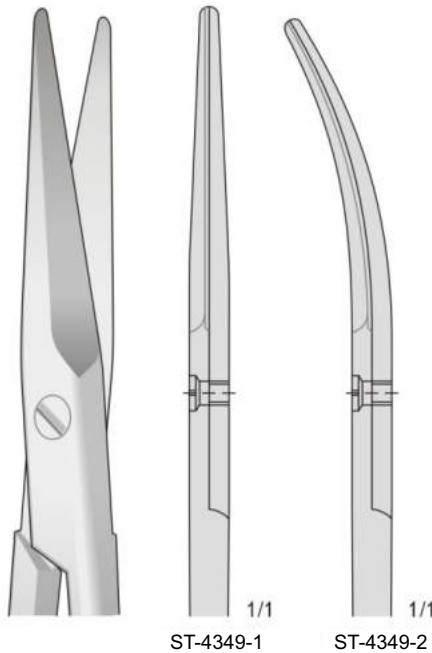
ST-4348-1
200 mm

ST-4348-2
230 mm

ST-4348-3
280 mm

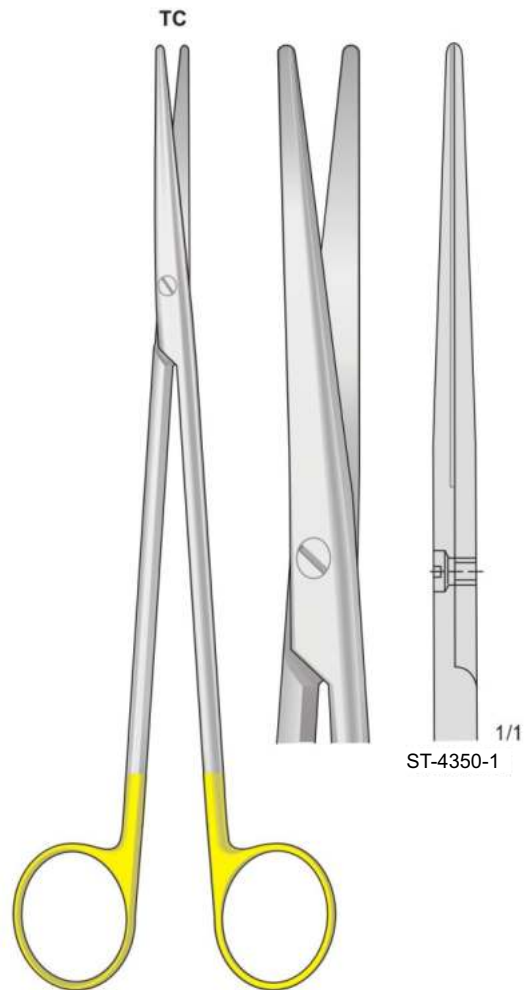


MAYO
ST-4349
155 mm



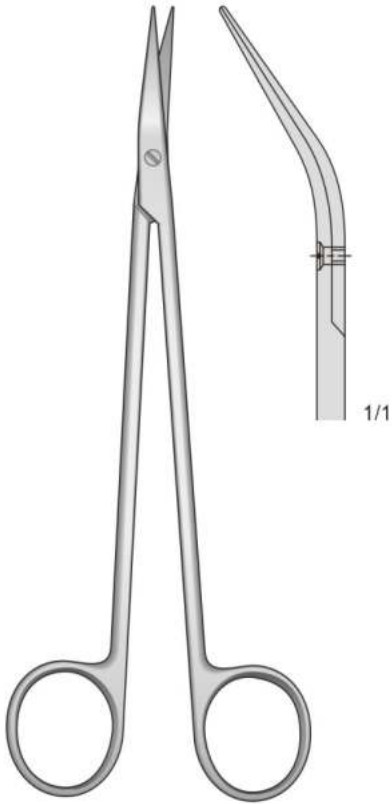
ST-4349-1

ST-4349-2

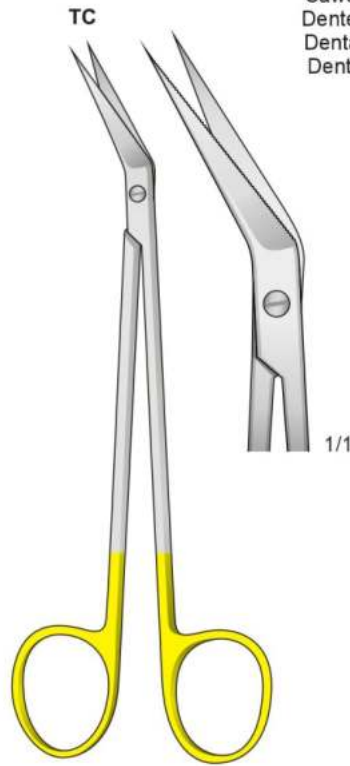


METZENBAUM
ST-4350
280 mm

ST-4350-1
1/1

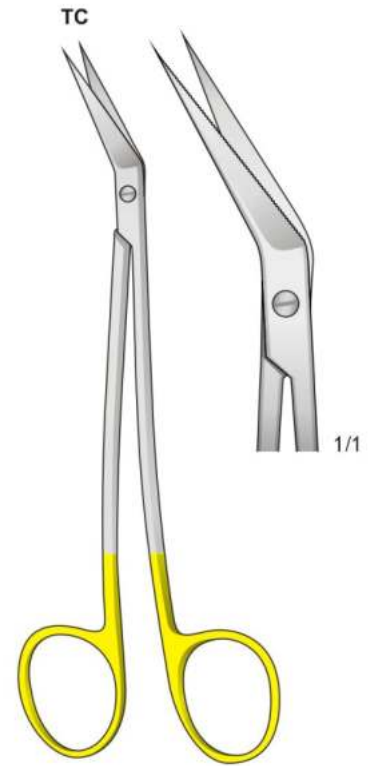


POTTS-SMITH
ST-4352
175 mm



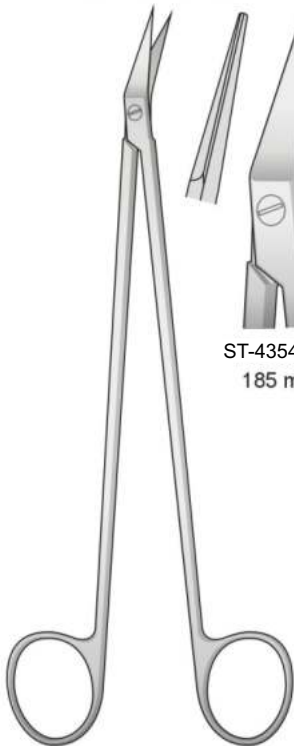
ST-4353
160 mm

Gezahnt
Sawedge
Dentellate
Dentadas
Dentelés



ST-4354
160 mm

Gefäßscheren
Vessel scissors



POTTS-DE MARTEL
ST-4354
185 mm

30°



ST-4354-1
185 mm

45°



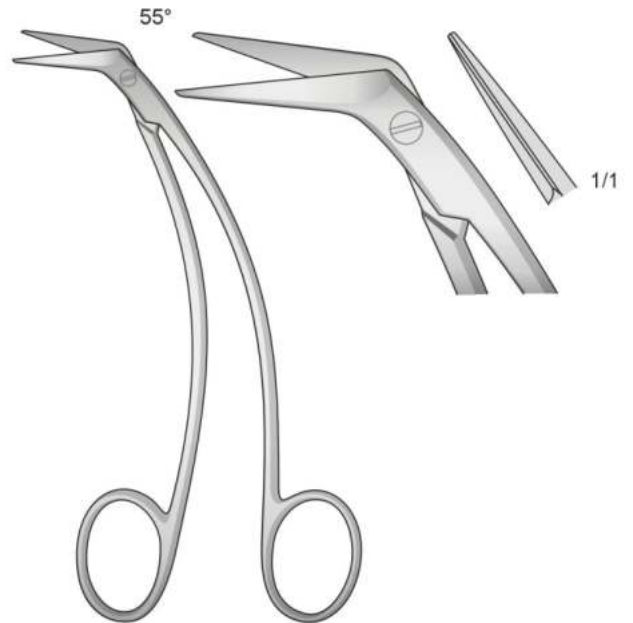
ST-4354-2
185 mm

60°

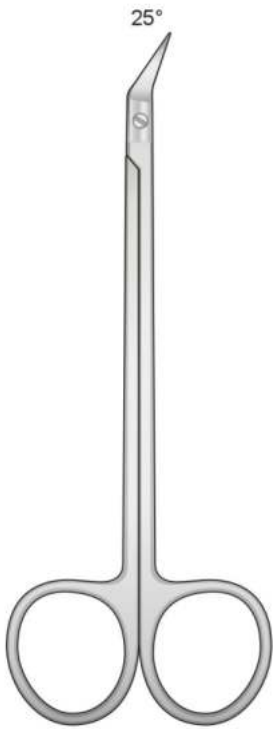


ST-4354-3
185 mm

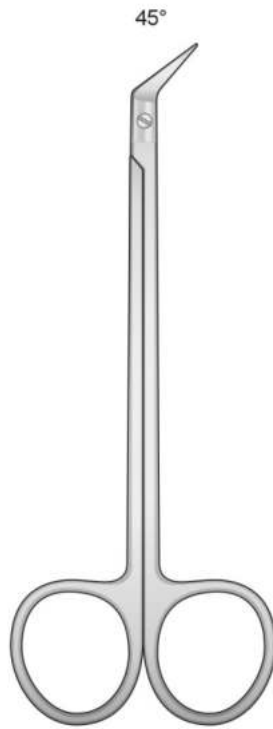
Coronararterien-Schere
Coronary artery scissors



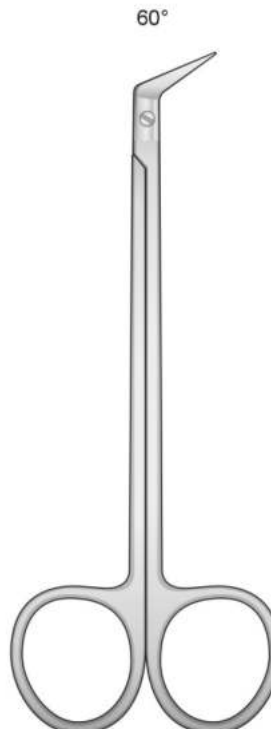
FAVOLORO
ST-4355
140 mm



ST-4356
135 mm



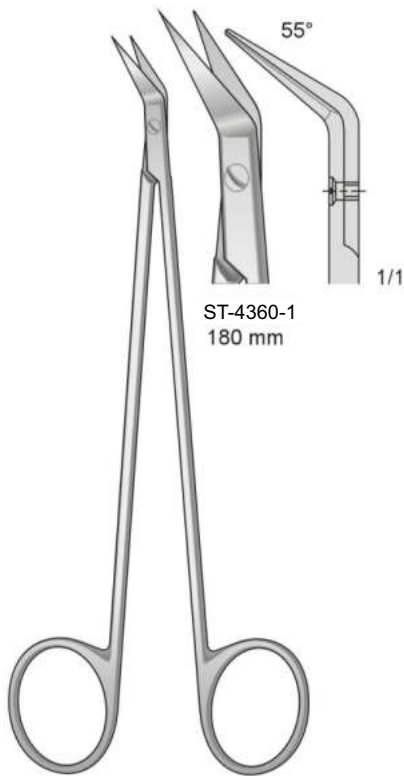
ST-4357
135 mm



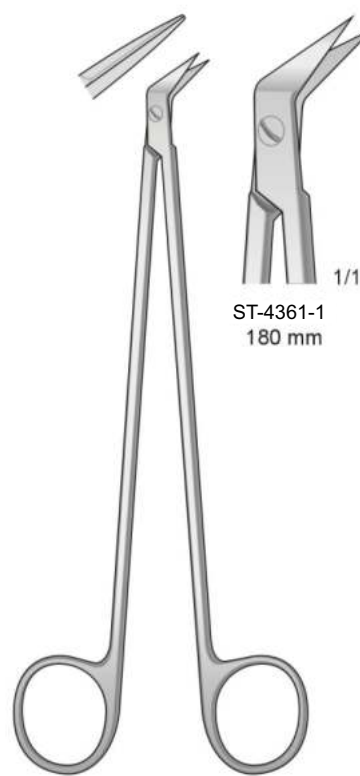
ST-4358
135 mm



ST-4359
135 mm



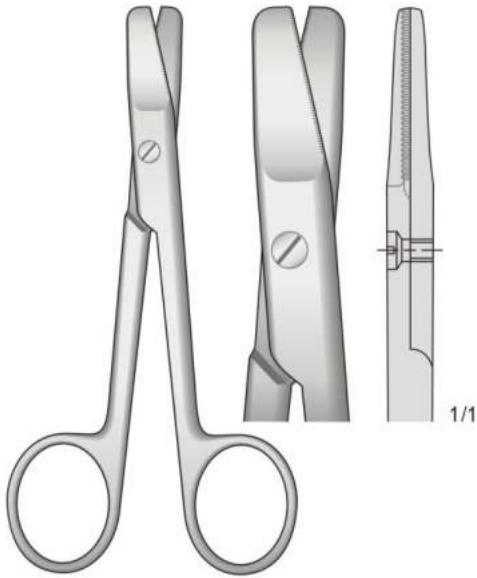
POTTS-SMITH
ST-4360
180 mm



POTTS-SMITH
ST-4361
180 mm



Gezahnt - Serrated
Dentellata - Dentadas
Dentelés



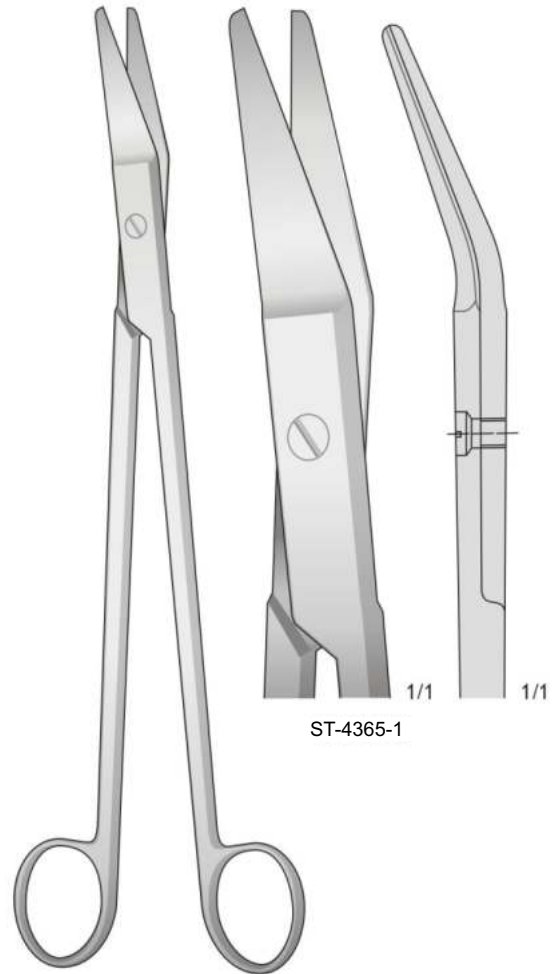
HARVEY
ST-4362
125 mm

Spitz - Sharp
Acuta - Agudo - Aigu



METZENBAUM
ST-4363
145 mm

Kapselschere
Forbice da cartilagine
Cartilage Scissors



RESANO
ST-4365
250 mm

Uterusschere
Uterine scissors

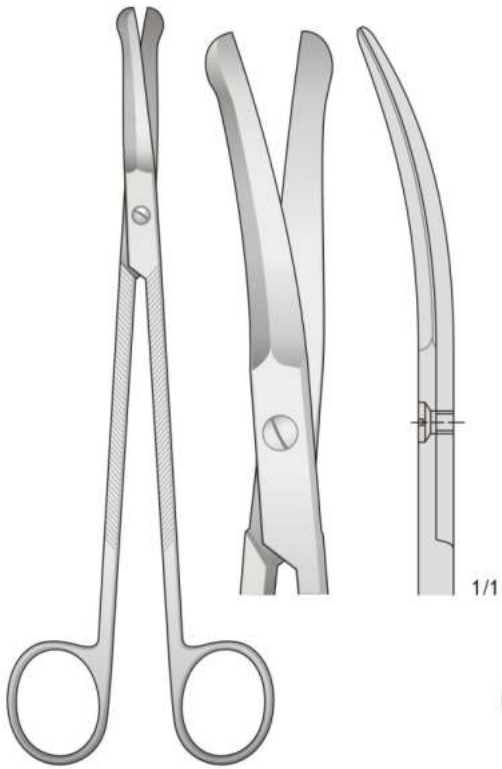


BOZEMANN
ST-4364
220 mm

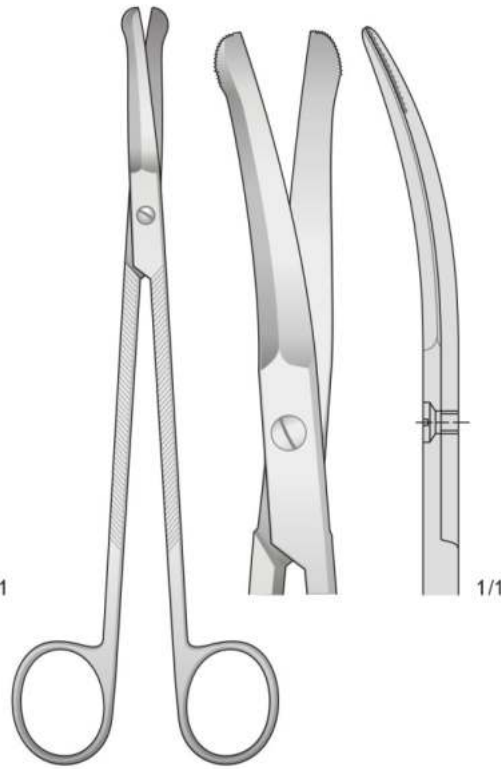


Gezahnt - Serrated
Dentellata - Dentadas - Dentées

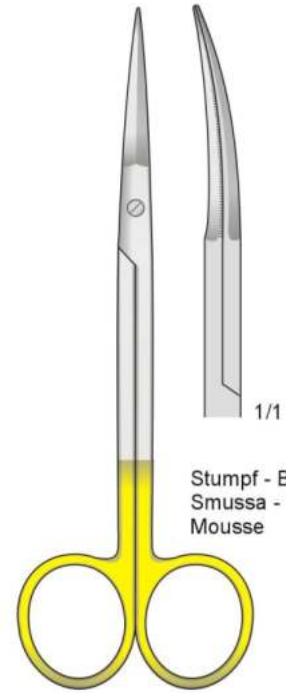
TC



GOOD
ST-4366
195 mm

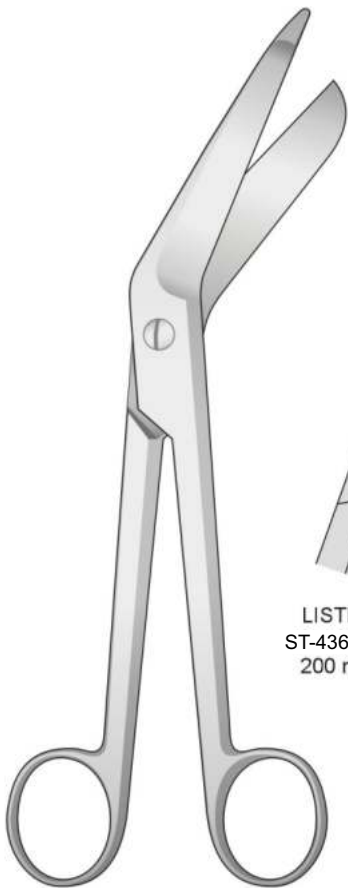


SCHWECKENDIEK
ST-4367
195 mm

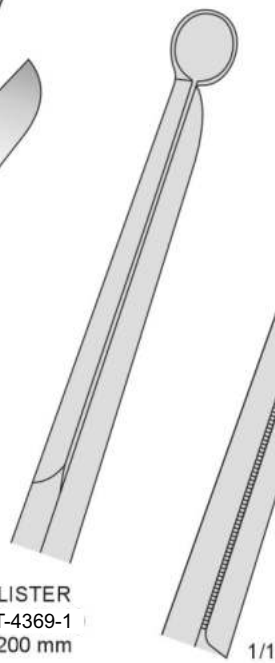


PECK-JOSEPH
ST-4368
140 mm

Stumpf - Blunt
Smussa - Romas
Mousse

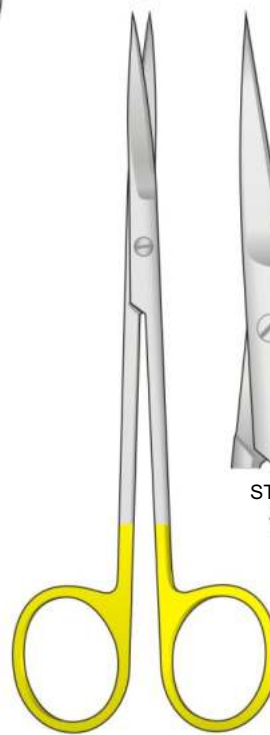


LISTER
ST-4369-1
200 mm

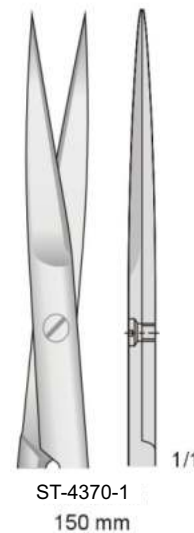


BERGMANN
ST-4369-2
230 mm

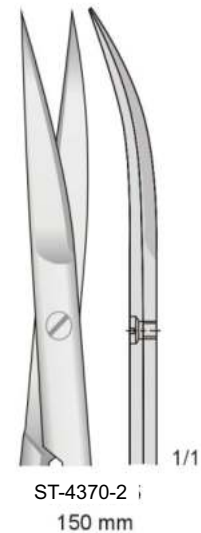
TC



JOSEPH
ST-4370
150 mm



ST-4370-1
150 mm

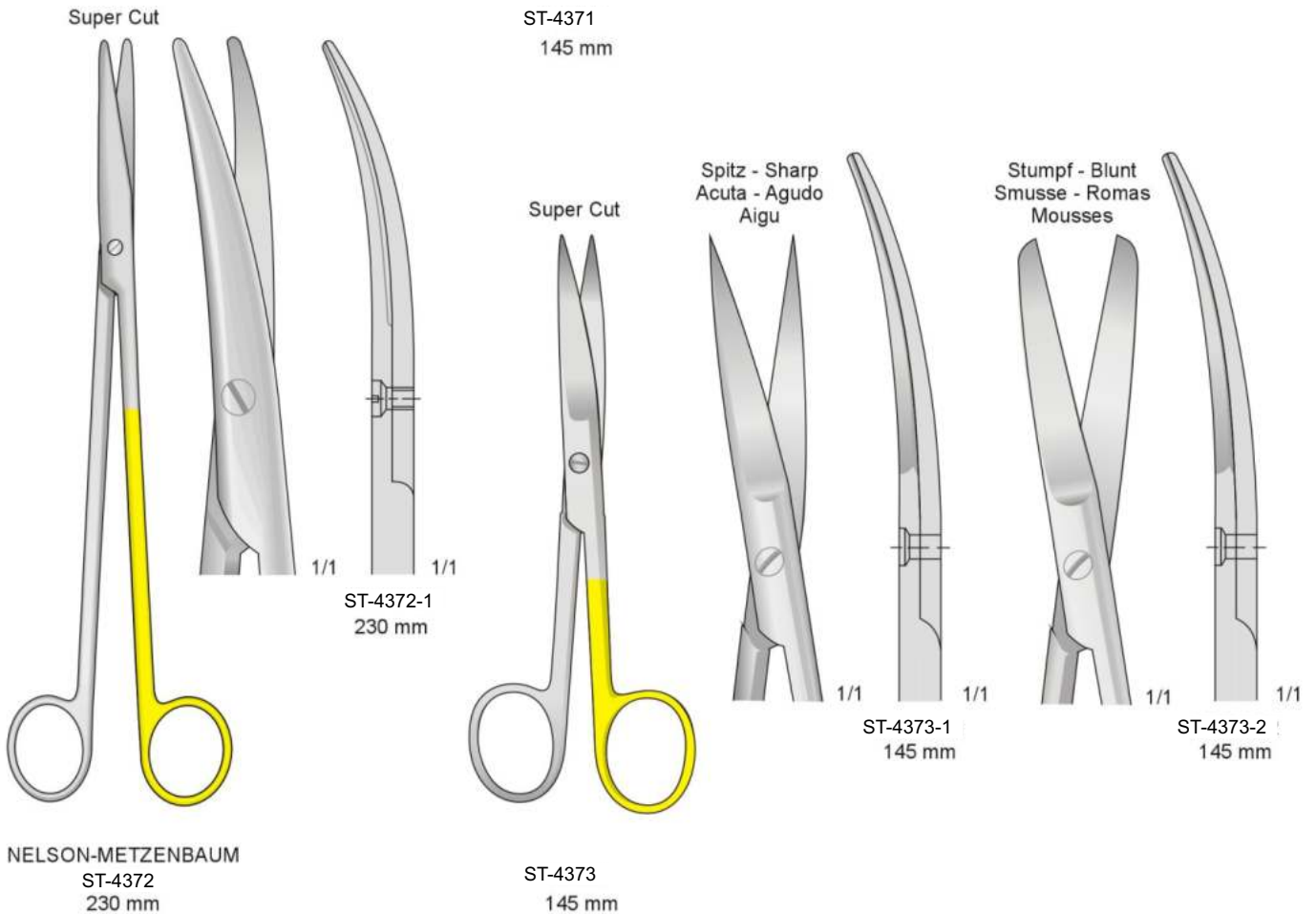
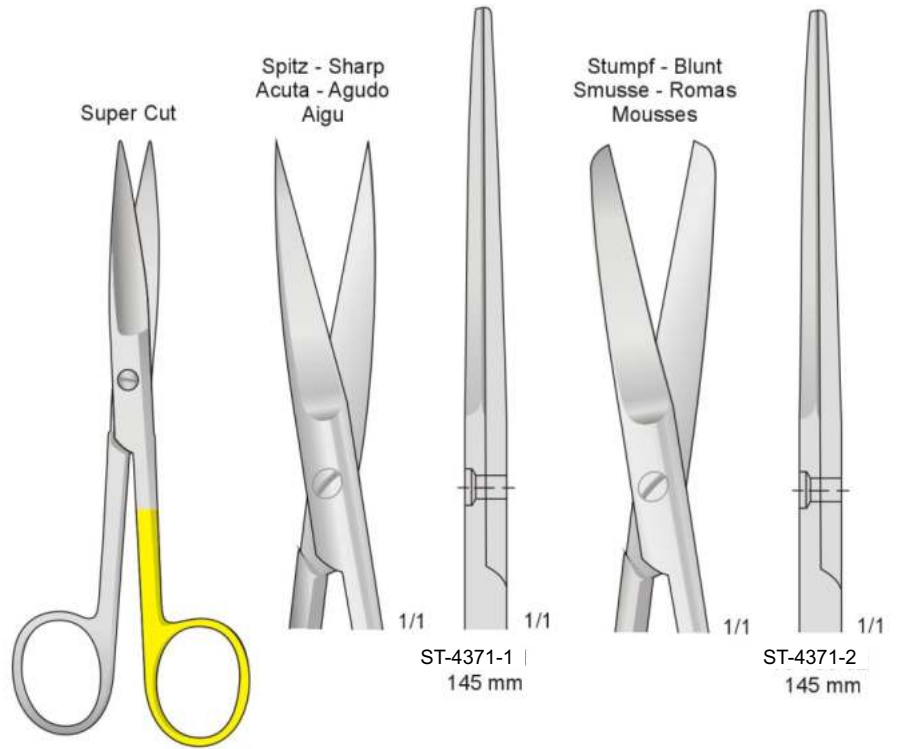


ST-4370-2
150 mm

ST-4369



"Super-cut" scheren micro-schliff für tissue atrauma
"Super-cut" scissors for gripping tissue and cutting interproximally
Forbici "super-cut" estremamente taglienti per tessuti con riduzione del trauma
Tijeras "super cortes" para cortar tissue-atrauma
Ciseaux "super cut" coupe les tissus en reduisant les risques de traumatisme



Mit Hartmetalleinsätzen
Tungsten-carbide scissors
Con punta al carburo di tungsteno
Tijeras de tungsteno
Avec plaquettes en carbure de tungstène

Mit eine Schneide gezahnt
With one blade serrated
Con una lama zigrinata
Con una hoja dentada
Avec lame dentèle

Super Cut
TC

Mit eine Schneide gezahnt
With one blade serrated
Con una lama zigrinata
Con una hoja dentada
Avec lame dentèle

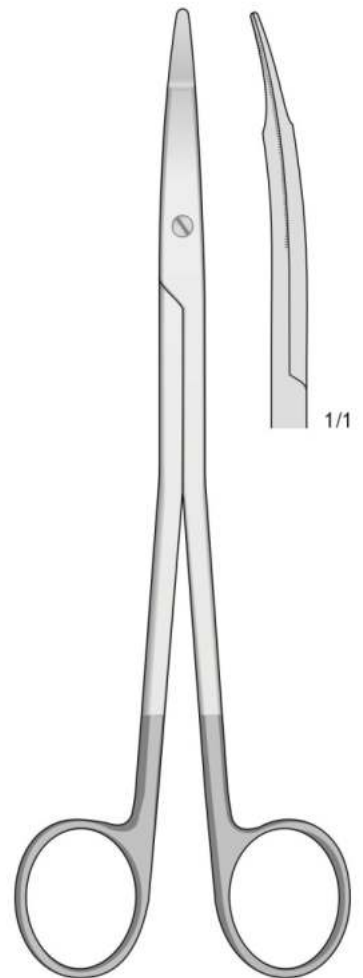
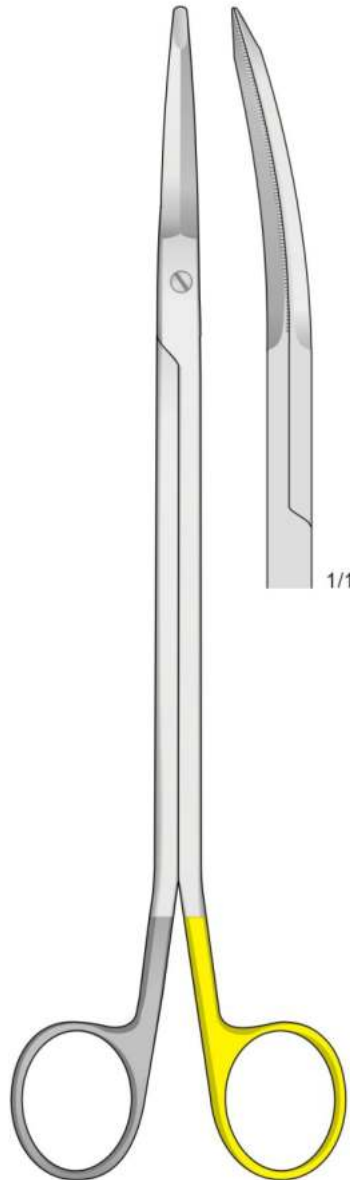
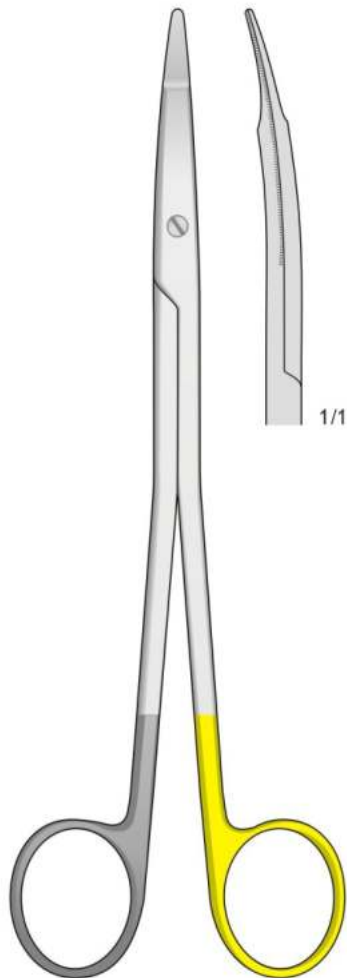
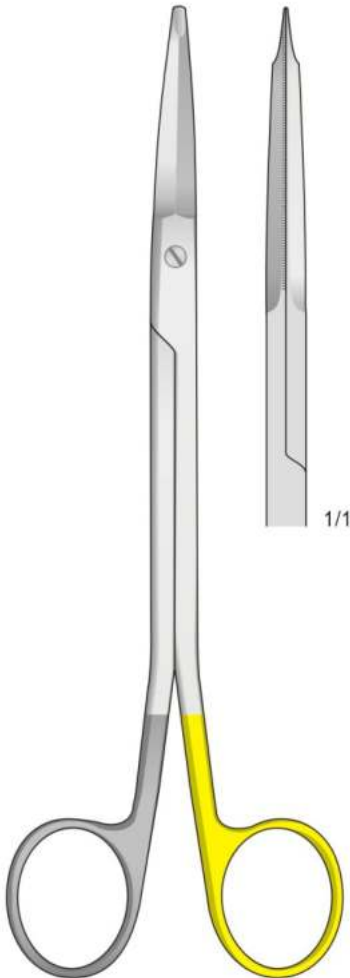
Super Cut
TC

Mit eine Schneide gezahnt
With one blade serrated
Con una lama zigrinata
Con una hoja dentada
Avec lame dentèle

Super Cut
TC

Mit eine Schneide gezahnt
With one blade serrated
Con una lama zigrinata
Con una hoja dentada
Avec lame dentèle

Super Cut



FREEMAN GORNEY
ST-4374
180 mm

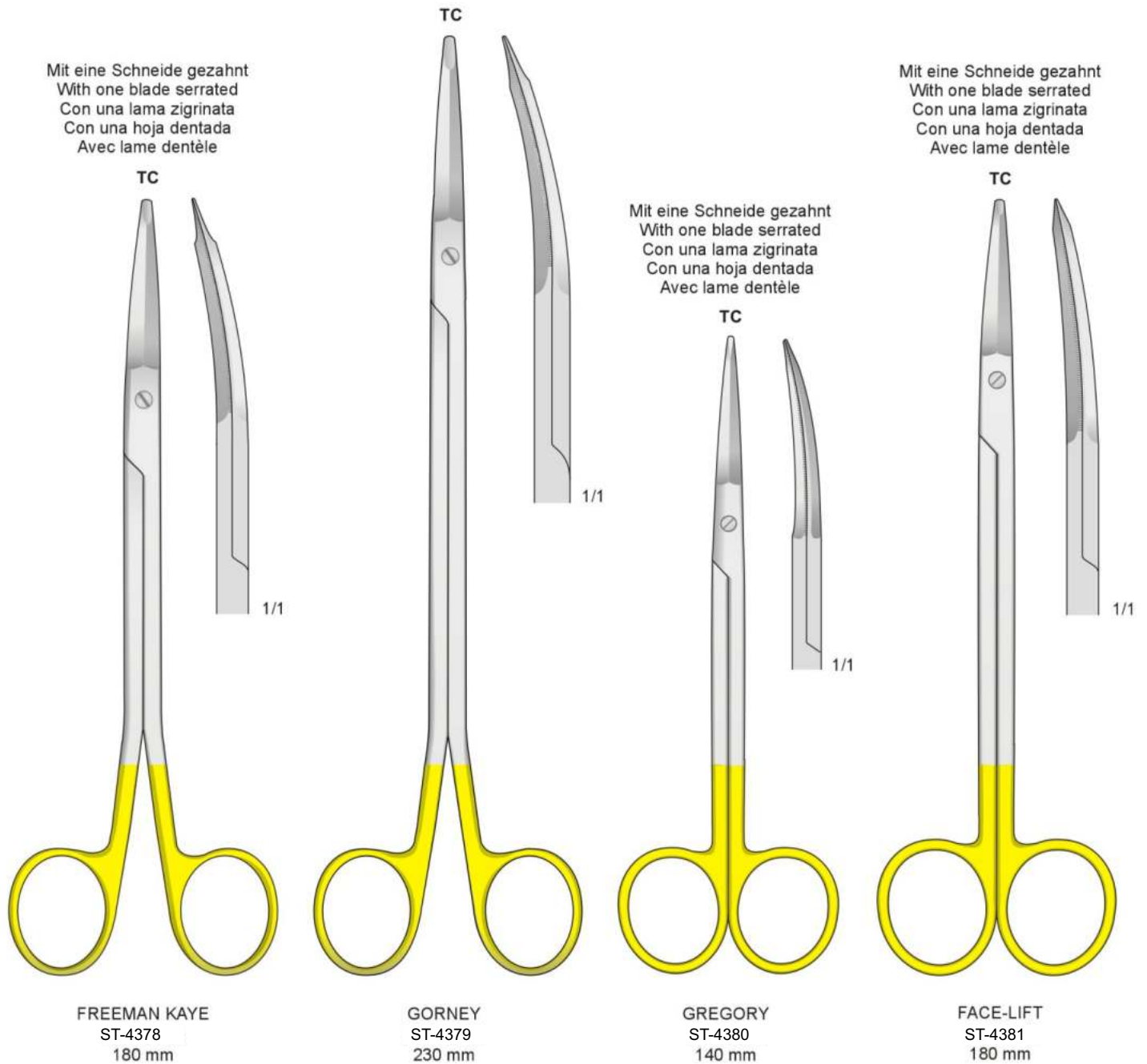
FREEMAN
ST-4375
180 mm

GORNEY
ST-4376
230 mm

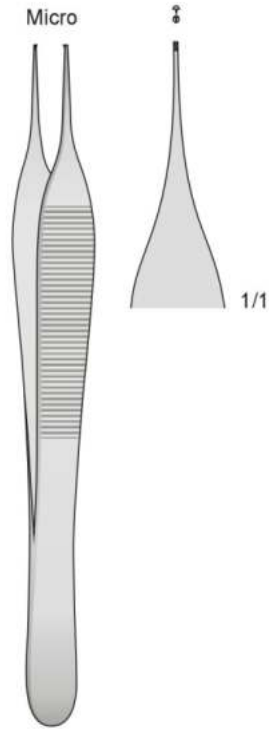
FREEMAN
ST-4377
180 mm

Mit Hartmetalleinsätzen
Tungsten-carbide scissors
Con punta al carburo di tungsteno
Tijeras de tungsteno
Avec plaquettes en carbure de tungstène

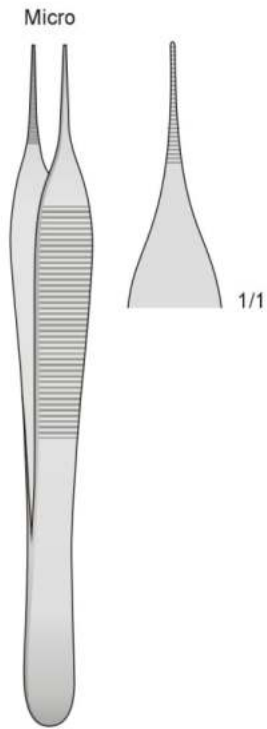
Mit eine Schneide gezahnt
With one blade serrated
Con una lama zigrinata
Con una hoja dentada
Avec lame dentèle



Pinzette mit Häkchen
Suturing Forceps
Pinzette per suture



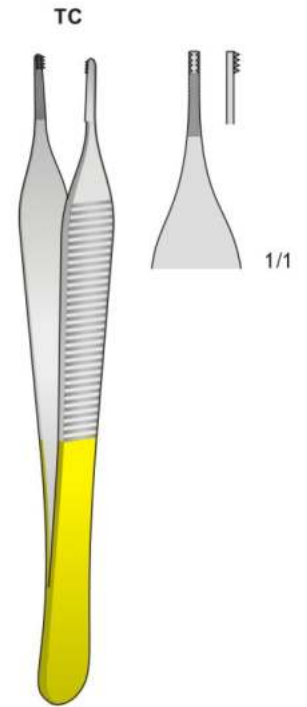
ADSON
ST-4382
150 mm



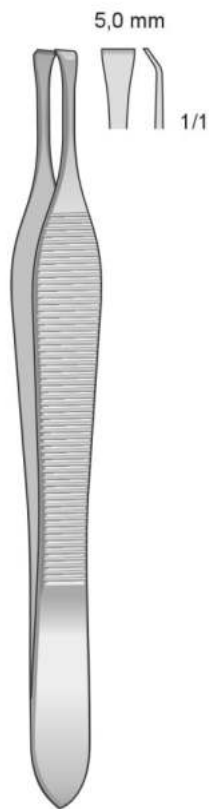
ADSON
ST-4383
150 mm



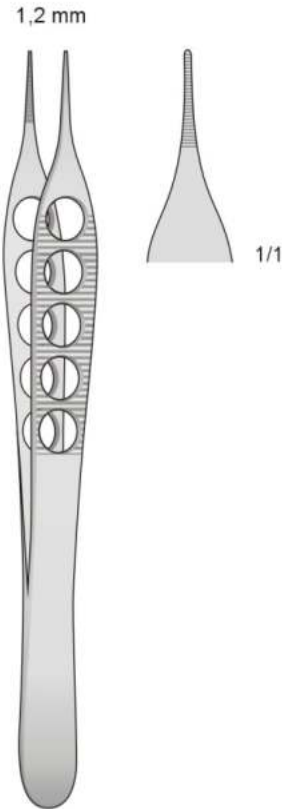
ADSON
ST-4384
125 mm



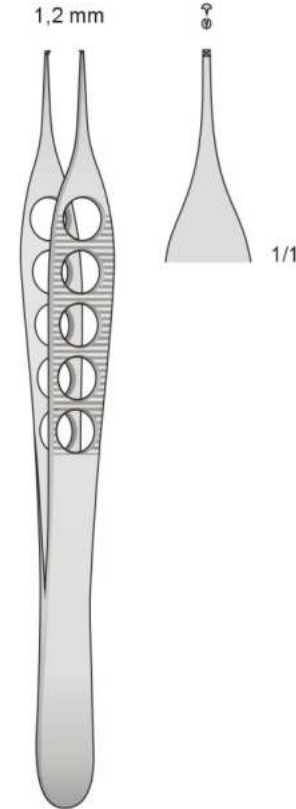
ADSON-BROWN
ST-4385
120 mm



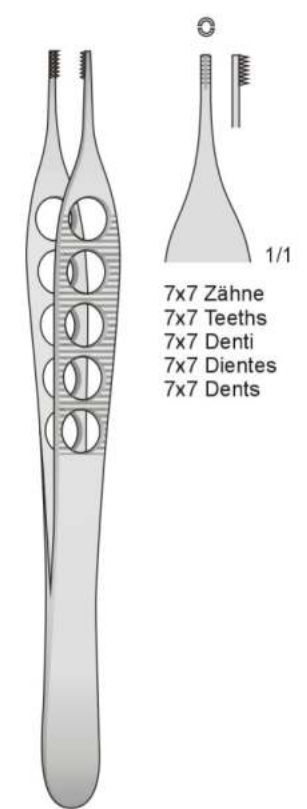
BEASLEY-BABCOCK
ST-4386
120 mm



ADSON
ST-4387
120 mm



ADSON
ST-4388
120 mm



ADSON-BROWN
ST-4389
120 mm

7x7 Zähne
7x7 Teeths
7x7 Denti
7x7 Dientes
7x7 Dents

TC

Mikroprofil - Micro profile
 Profilo micro - Perfil micro - Profil micro
 2.0 mm

ST-4390-1 160 mm ST-4390-2 200 mm ST-4390-3 245 mm

DE BAKEY
ST-4390

TC

ST-4391-1 175 mm ST-4391-2 175 mm

1x2 Zähne
 1x2 Teeth
 1x2 Denti
 1x2 Dientes

GERALD
ST-4391
175 mm

ST-4392-1 180 mm

1x2 Zähne
 1x2 Teeth
 1x2 Denti
 1x2 Dientes

BONNEY
ST-4392
180 mm

ST-4393-1 150 mm ST-4393-2 150 mm

McINDOE
ST-4393
150 mm

ST-4394-1 150 mm ST-4394-2 150 mm

GILLIES
ST-4394
150 mm

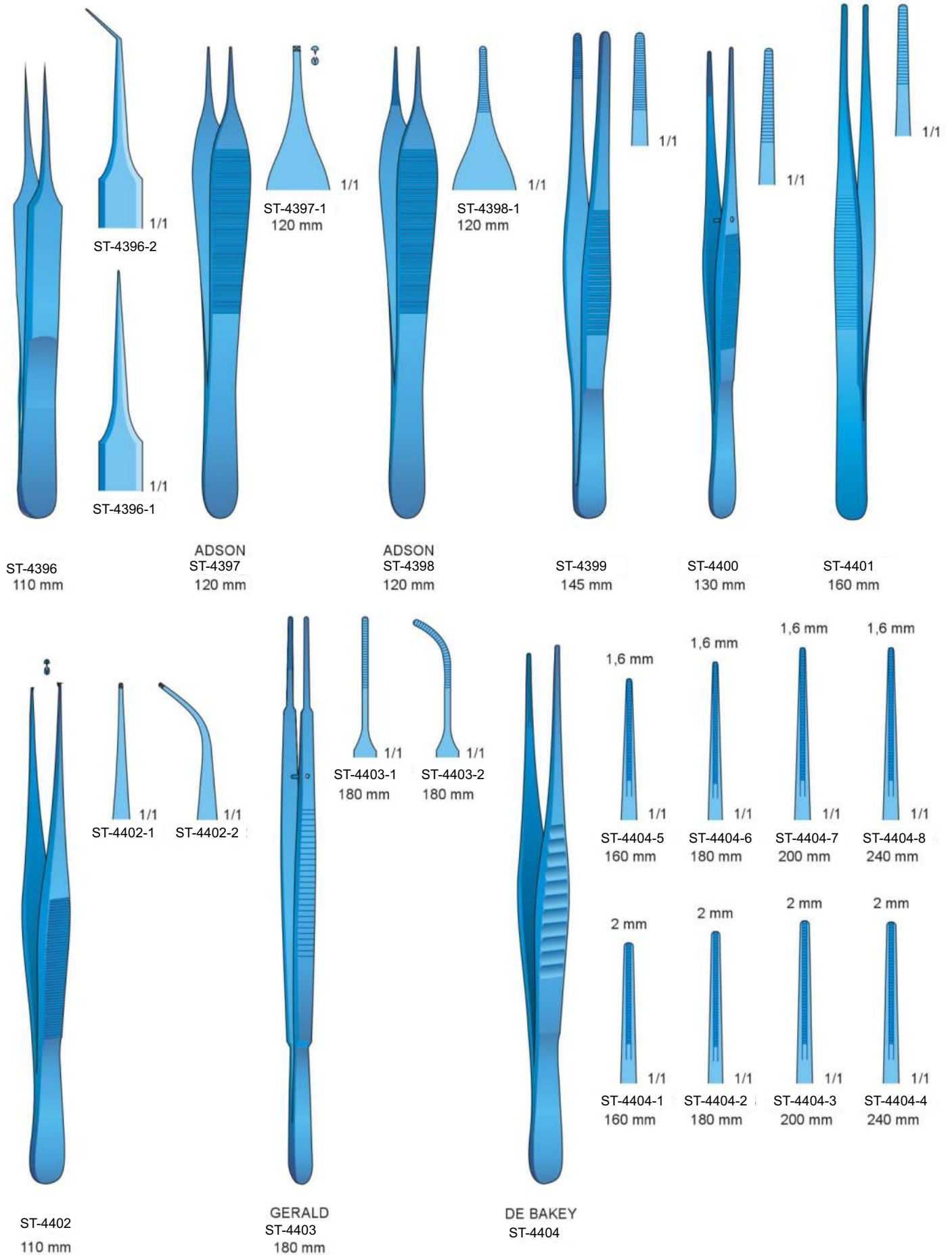
ST-4395-1 150 mm ST-4395-2 150 mm ST-4395-3 175 mm

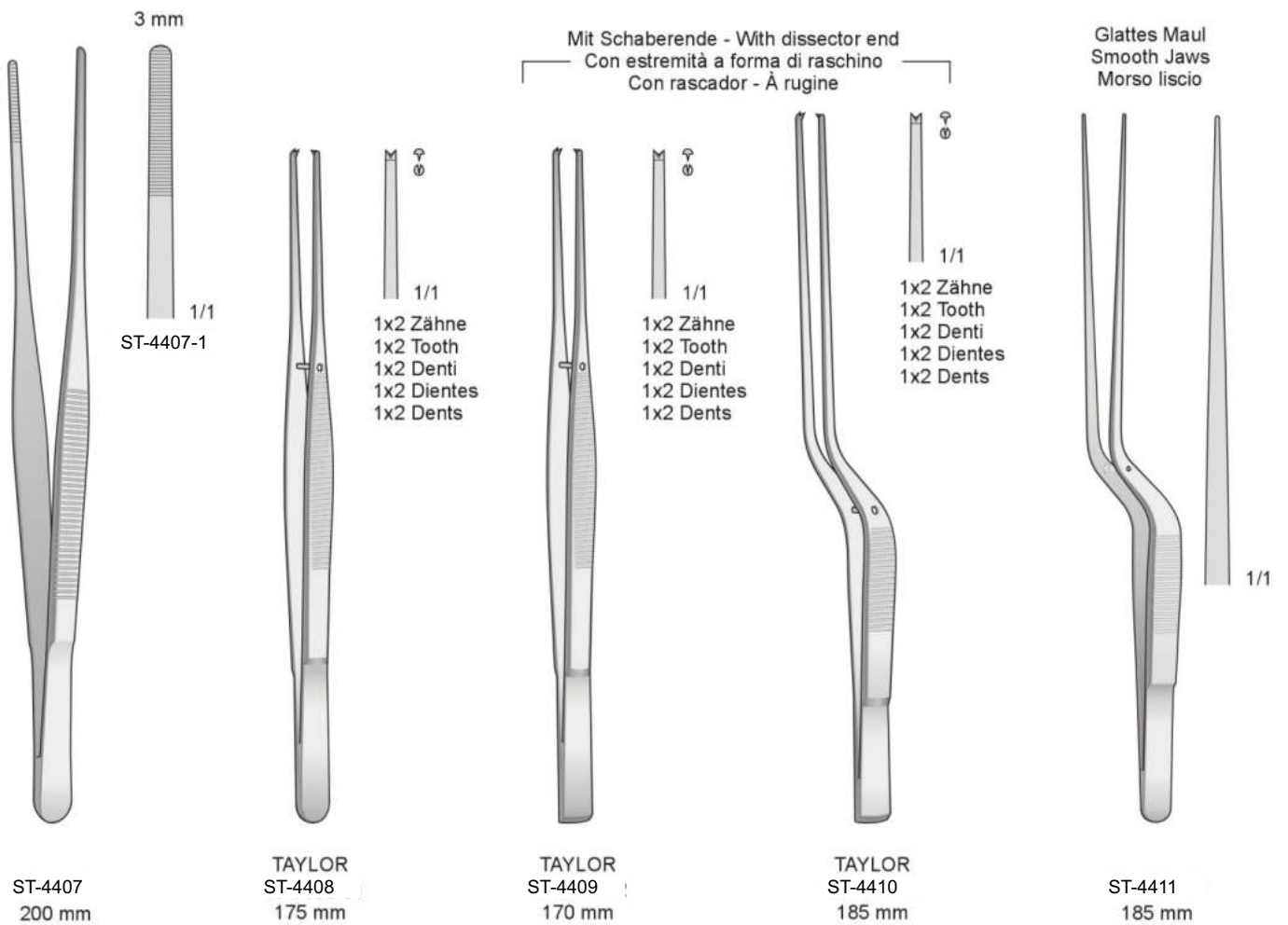
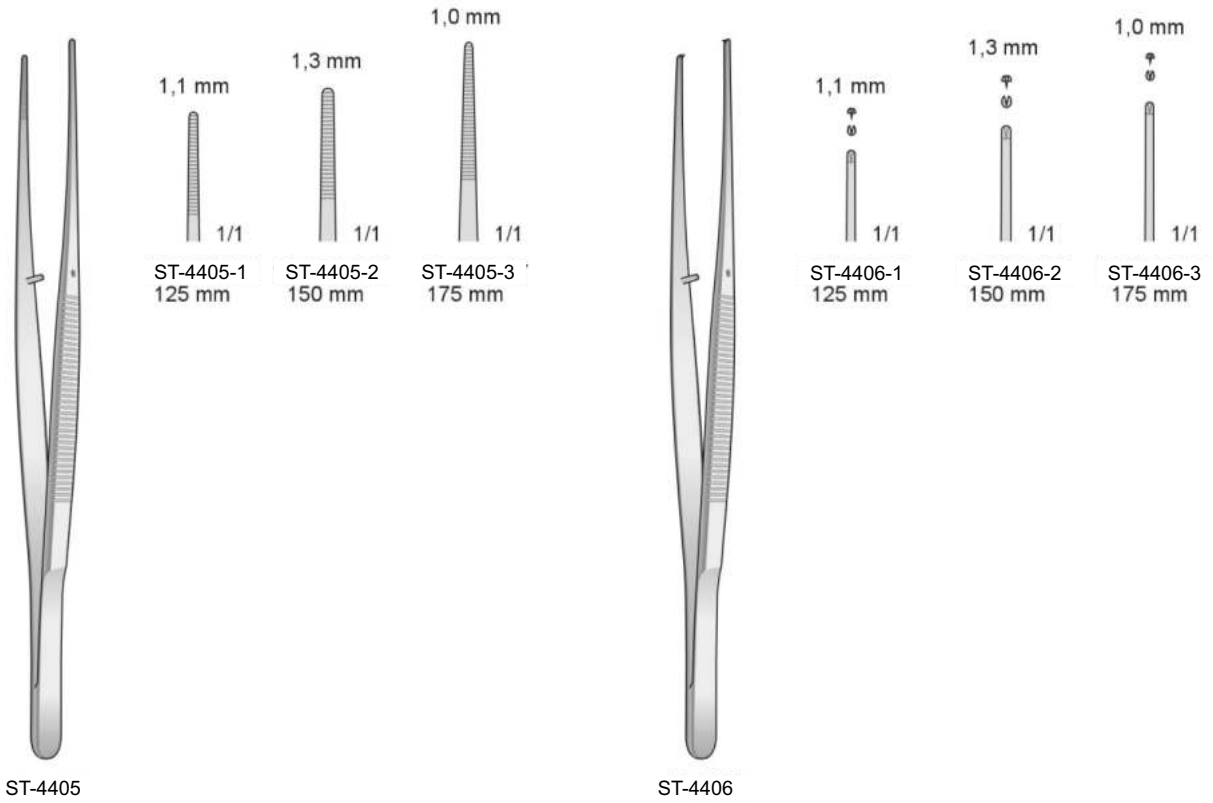
1x2 Zähne 2x3 Zähne 1x2 Zähne
 1x2 Teeth 2x3 Teeth 1x2 Teeth
 1x2 Denti 2x3 Denti 1x2 Denti
 1x2 Dientes 2x3 Dientes 1x2 Dientes

LANE
ST-4395



Titan - Titanium - Titanio - Titane



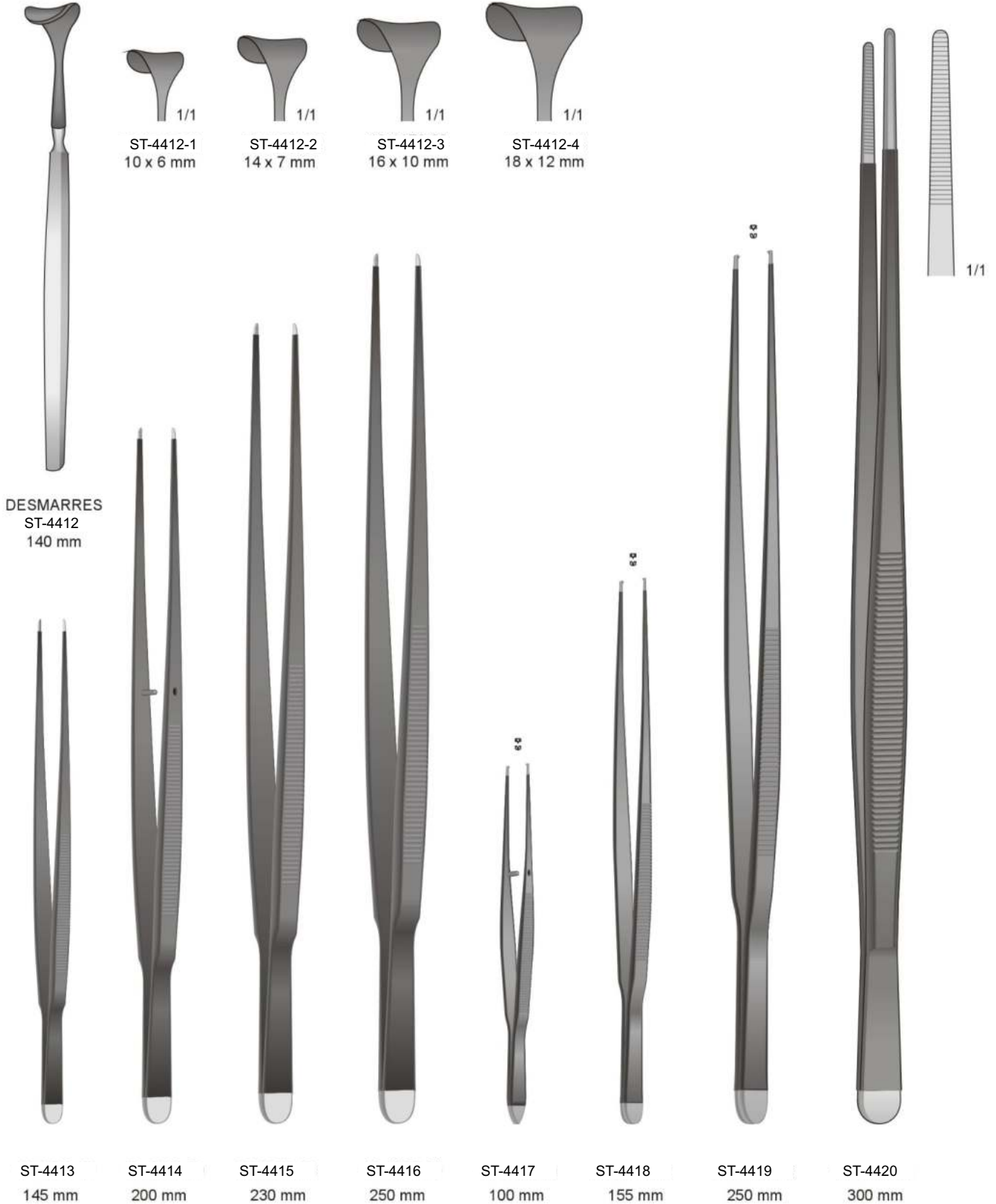


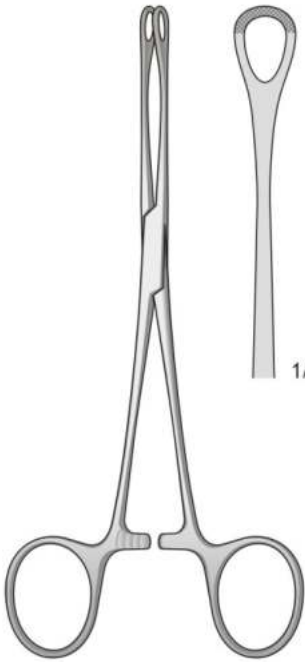


Isoliert - Insulated - Isolate - Aislante - Isolant
Monopolar - Monopolari

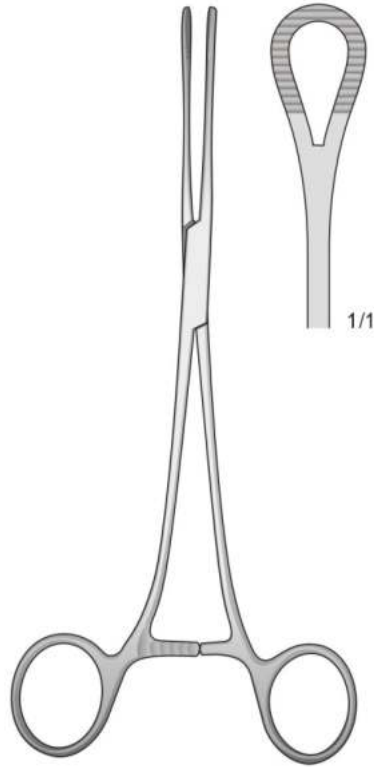
new

mit sterilisierfähiger Kunststoff-Isolierbeschichtung - with autoclavable plastic coated insulated handles
con rivestimento isolante in plastica sterilizzabile - con recubrimiento aislante de materia plástica esterilizable
à enduit plastique isolant, stérilisable

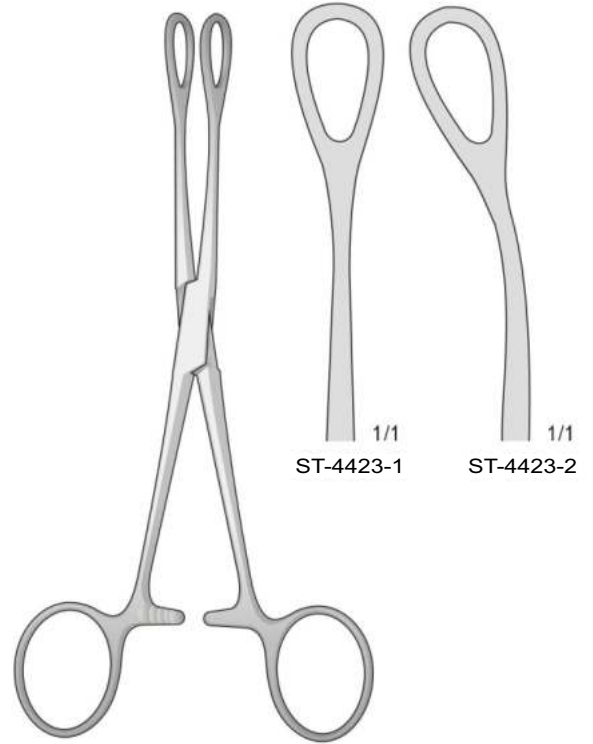




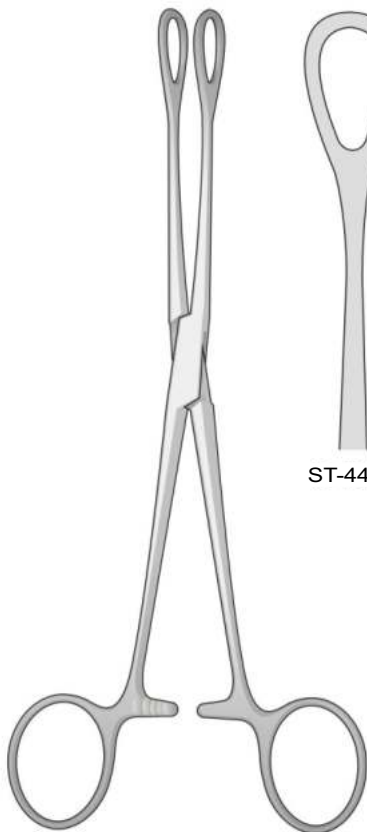
WILLIAMS
ST-4421
165 mm



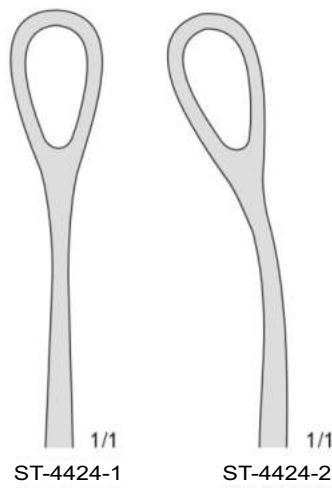
ST-4422
200 mm



FOERSTER
ST-4423
180 mm

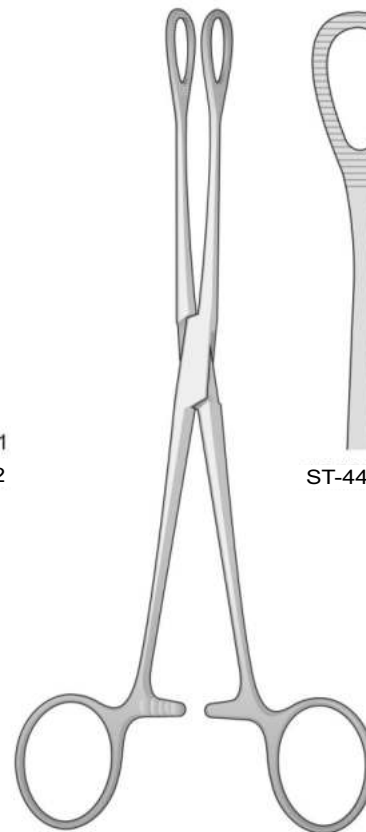


FOERSTER
ST-4424
200 mm

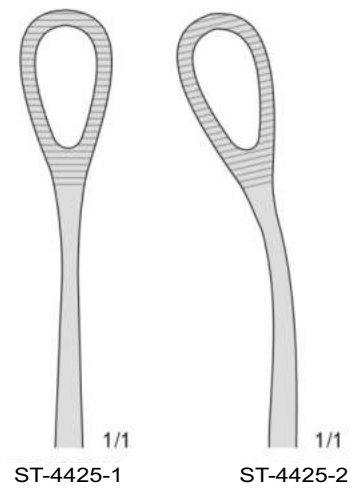


ST-4424-1

ST-4424-2

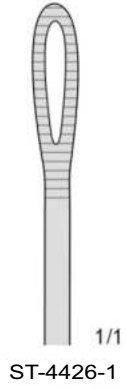
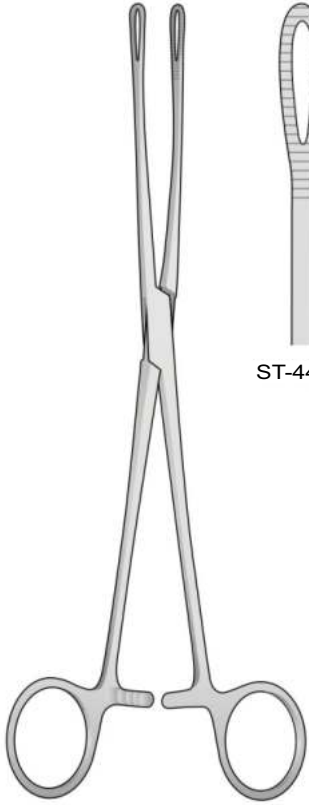


FOERSTER
ST-4425
200 mm

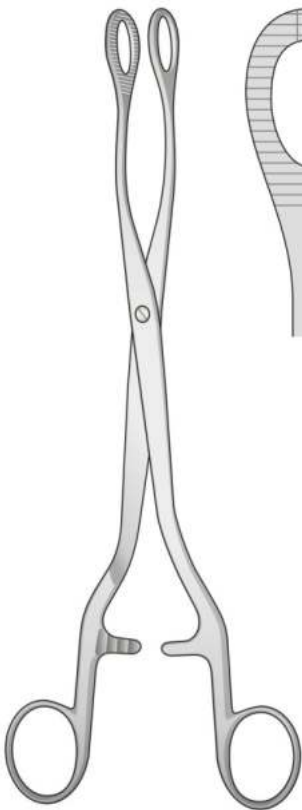


ST-4425-1

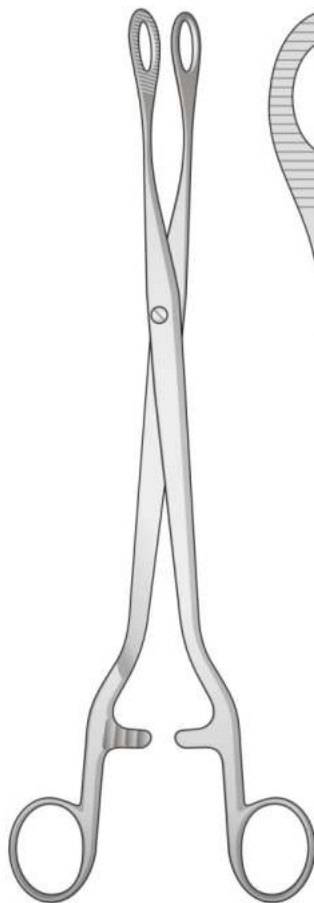
ST-4425-2



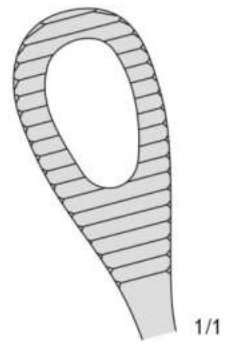
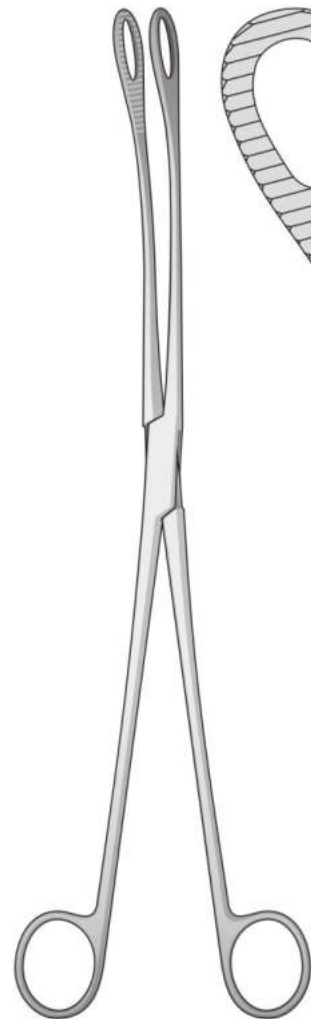
FOERSTER
ST-4426
250 mm



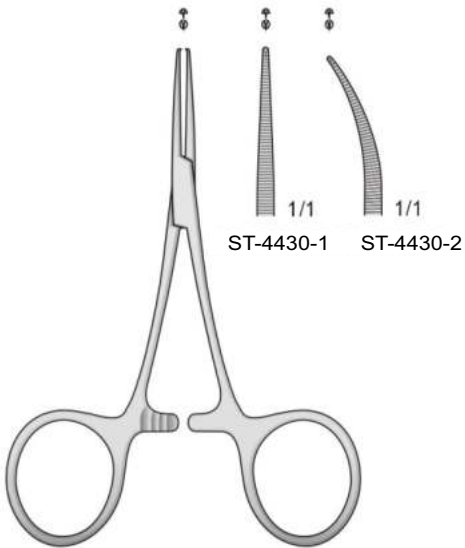
HEYWOOD-SMITH
ST-4427
250 mm



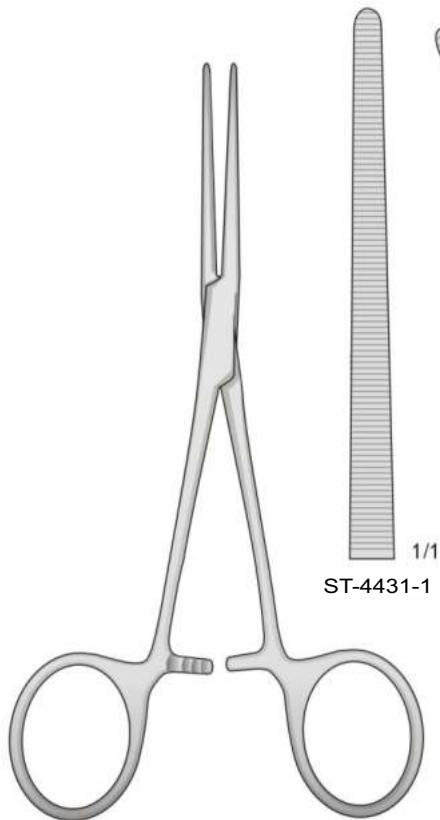
NOTO
ST-4428
280 mm



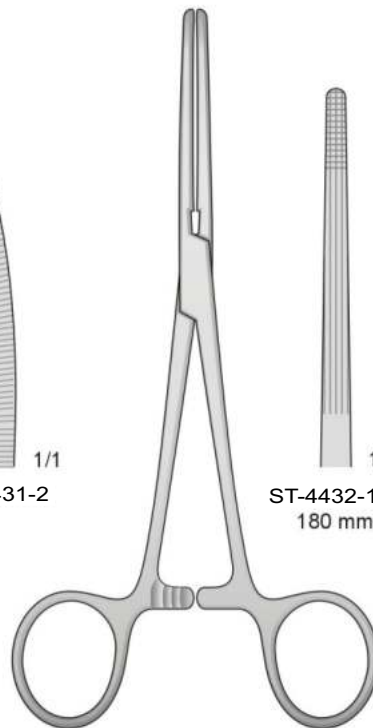
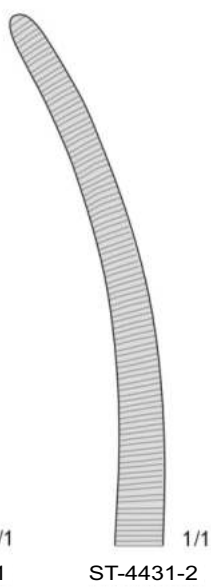
KELLY
ST-4429
320 mm



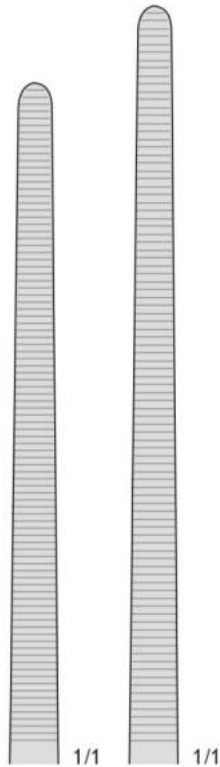
HARTMANN-BABY-MOSQUITO
ST-4430
95 mm



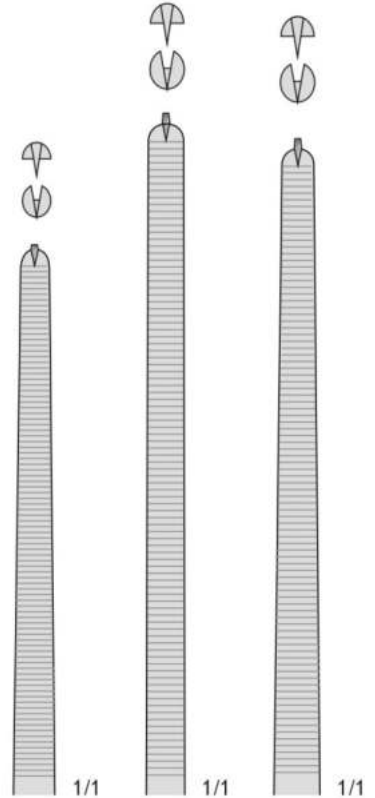
ROCHESTER-PEAN
ST-4431
225 mm



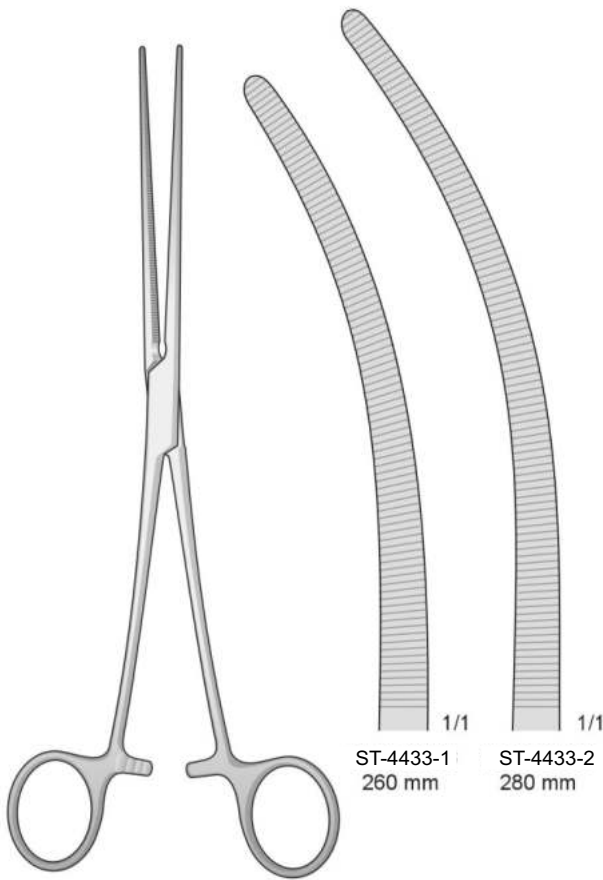
ROCHESTER-CARMALT
ST-4432



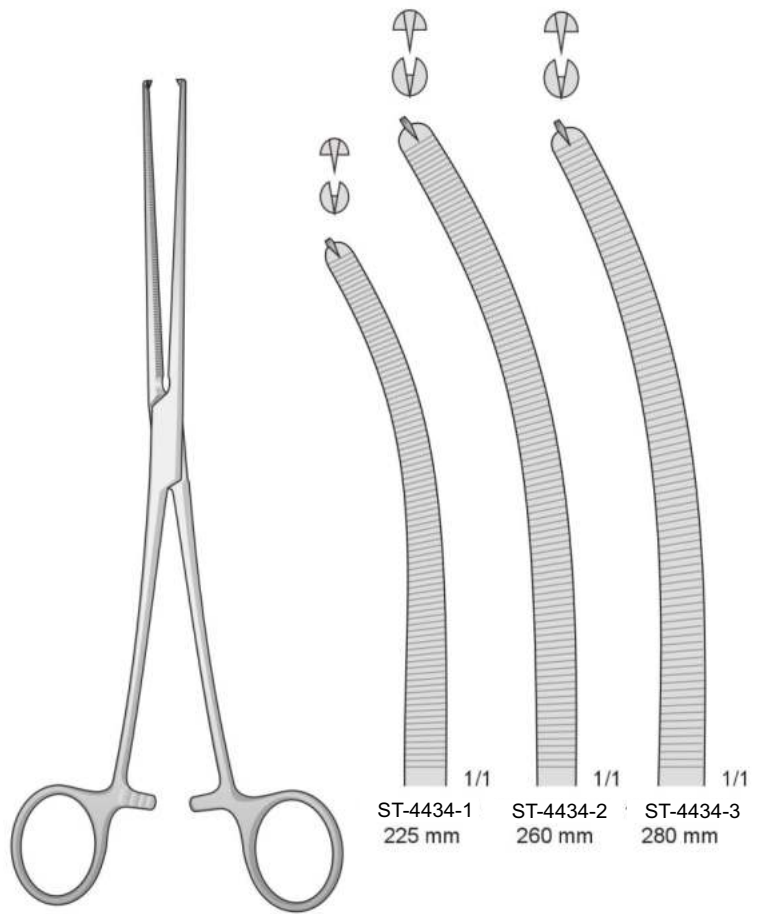
ST-4433-3 260 mm ST-4433-4 280 mm



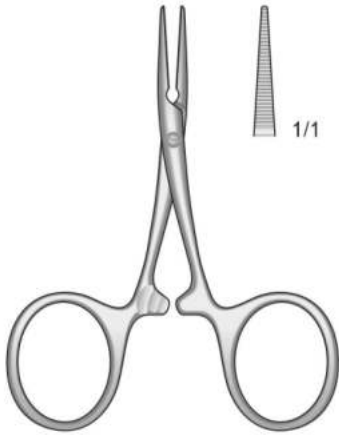
ST-4434-4 225 mm ST-4434-5 260 mm ST-4434-6 280 mm



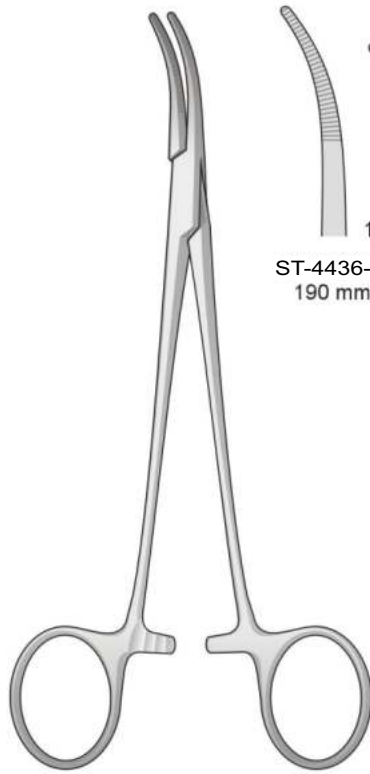
PEAN
ST-4433



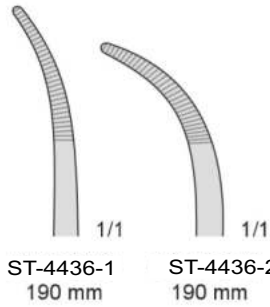
KOCHER-OCHSNER
ST-4434



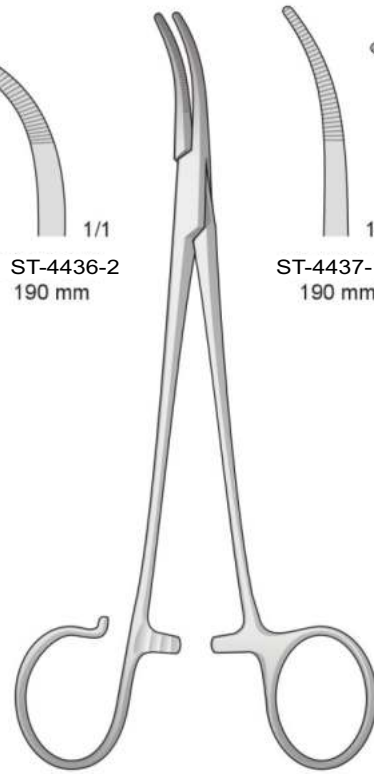
CARREL
ST-4435
85 mm



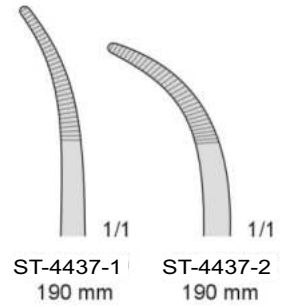
SCHNIDT
ST-4436
190 mm



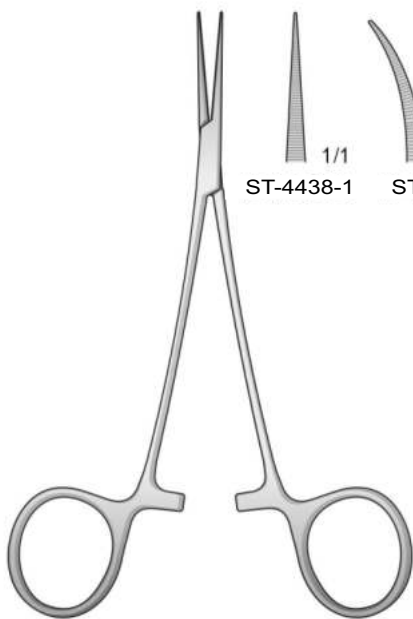
ST-4436-2
190 mm



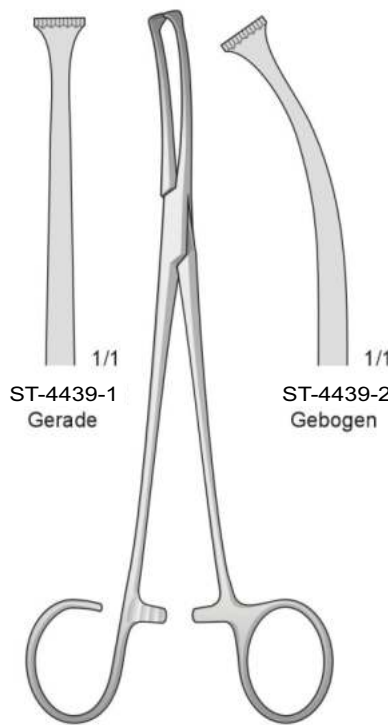
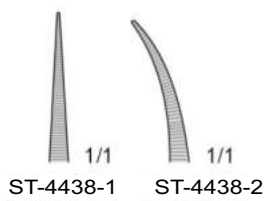
SCHNIDT
ST-4437
190 mm



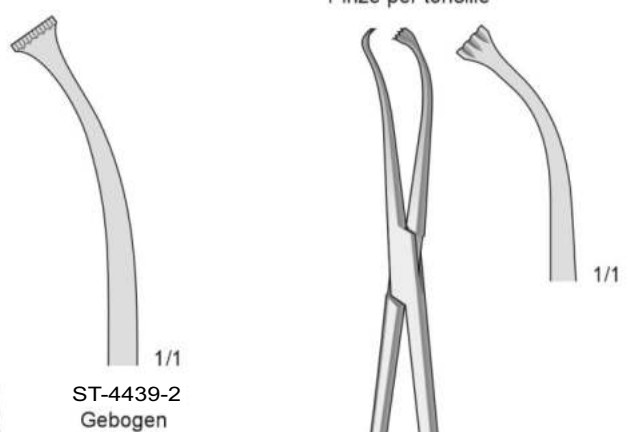
ST-4437-2
190 mm



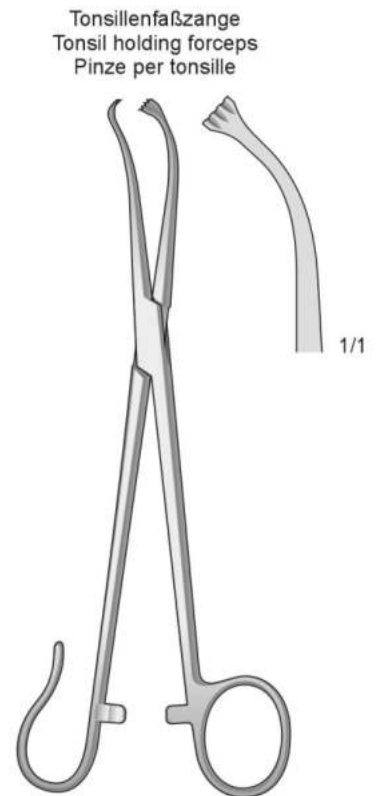
JACOBSON-MICRO
ST-4438
130 mm



ST-4439-1
Gerade

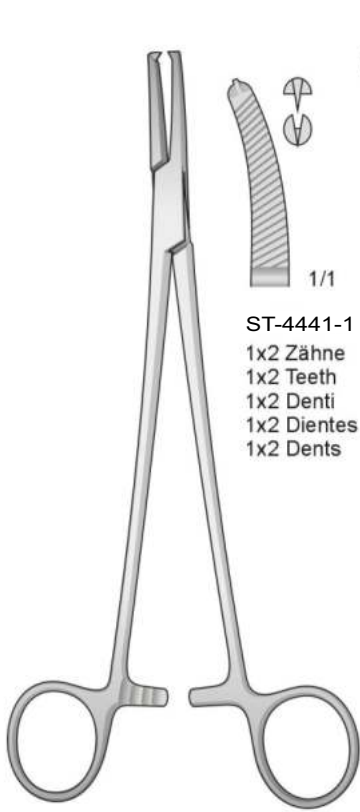


ST-4439-2
Gebogen



WHITE
ST-4440
180 mm

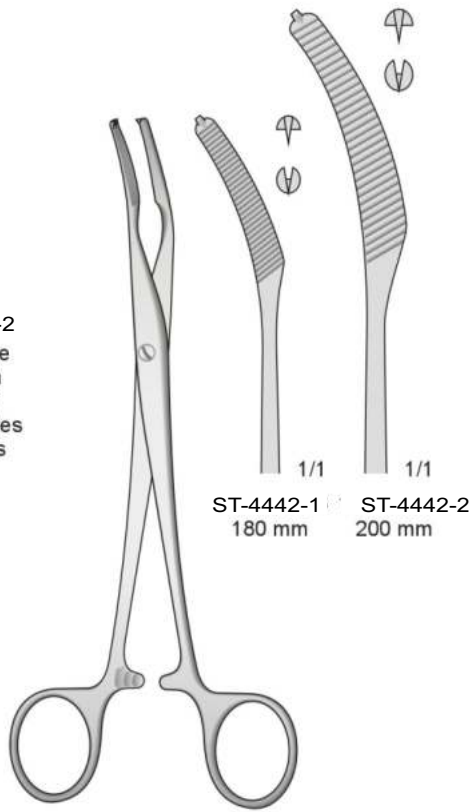
Tonsillenfaßzange
Tonsil holding forceps
Pinze per tonsille



ST-4441-1
1x2 Zähne
1x2 Teeth
1x2 Denti
1x2 Dientes
1x2 Dents

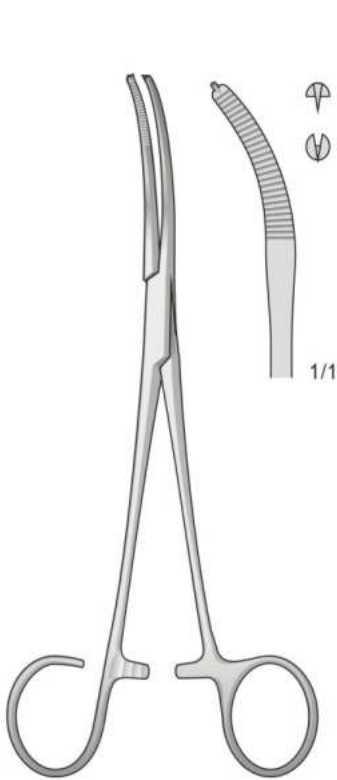
ST-4441-2
1x2 Zähne
1x2 Teeth
1x2 Denti
1x2 Dientes
1x2 Dents

FAURE
ST-4441
200 mm

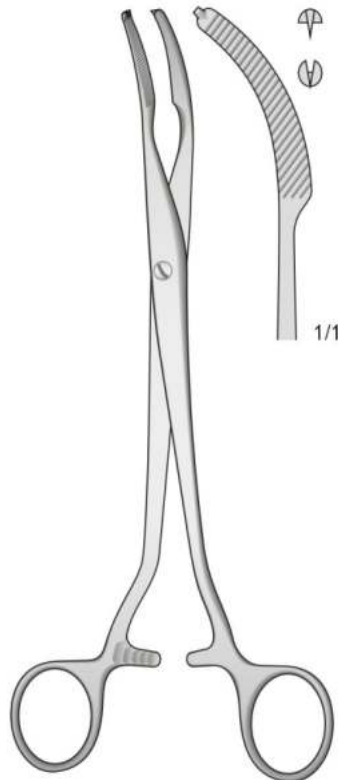


ST-4442-1 180 mm
ST-4442-2 200 mm

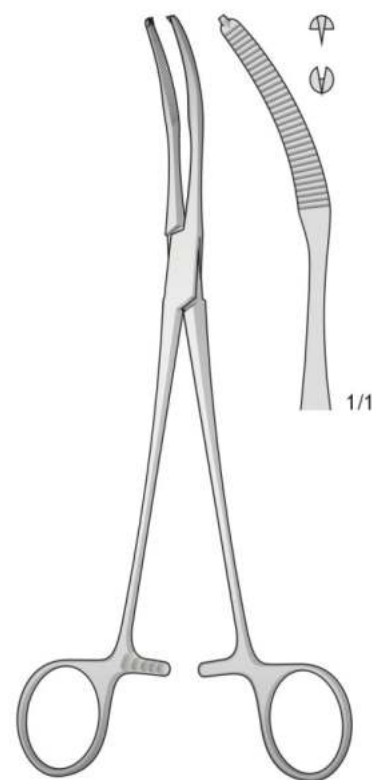
MIKULICZ
ST-4442



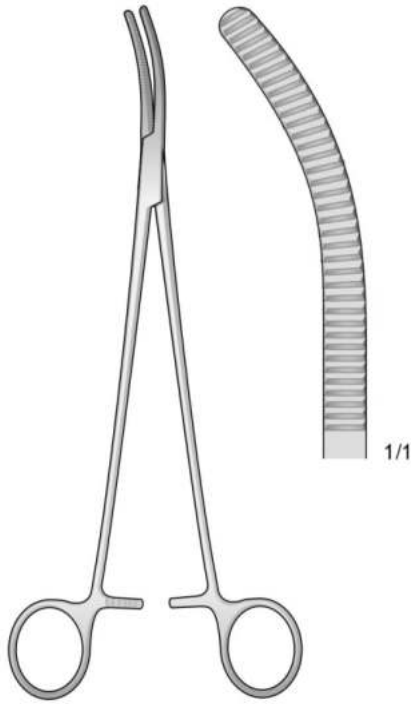
MIKULICZ
ST-4443
185 mm



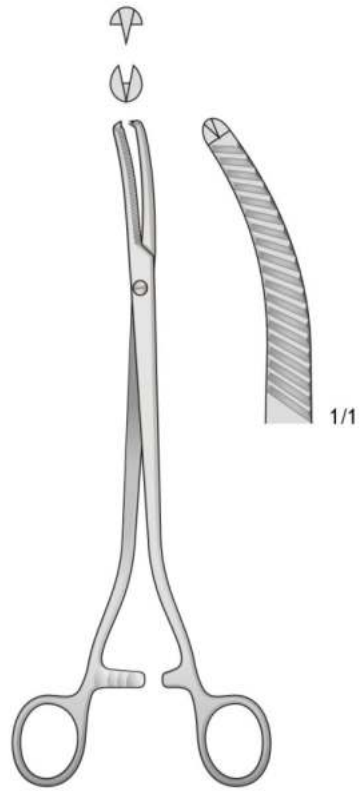
MIKULICZ
ST-4444
200 mm



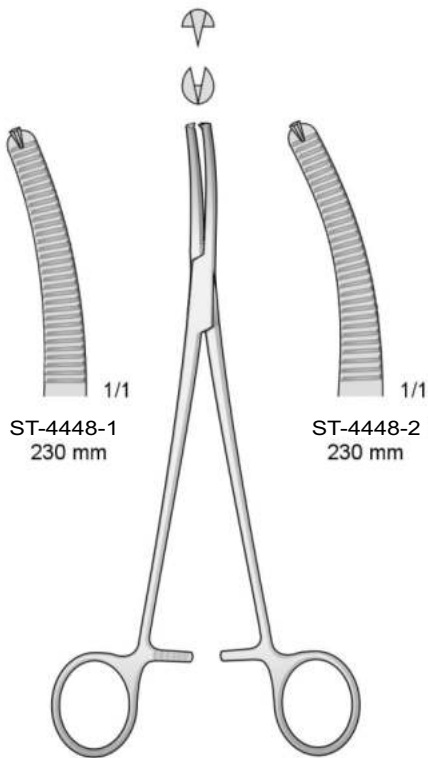
MIKULICZ
ST-4445
200 mm



WERTHEIM
ST-4446
250 mm



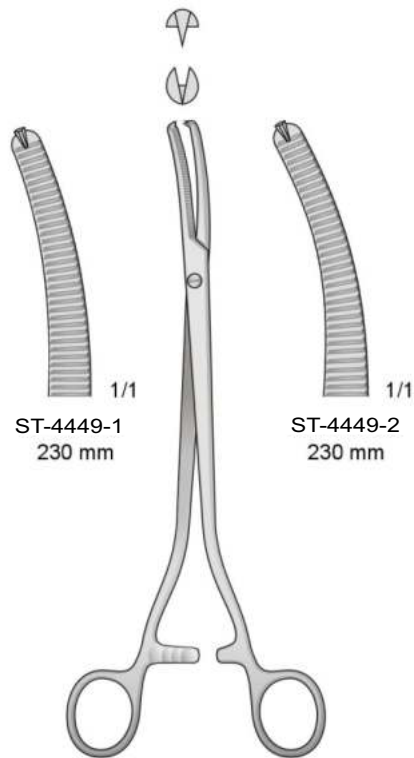
WERTHEIM
ST-4447
230 mm



ST-4448-1
230 mm

ST-4448-2
230 mm

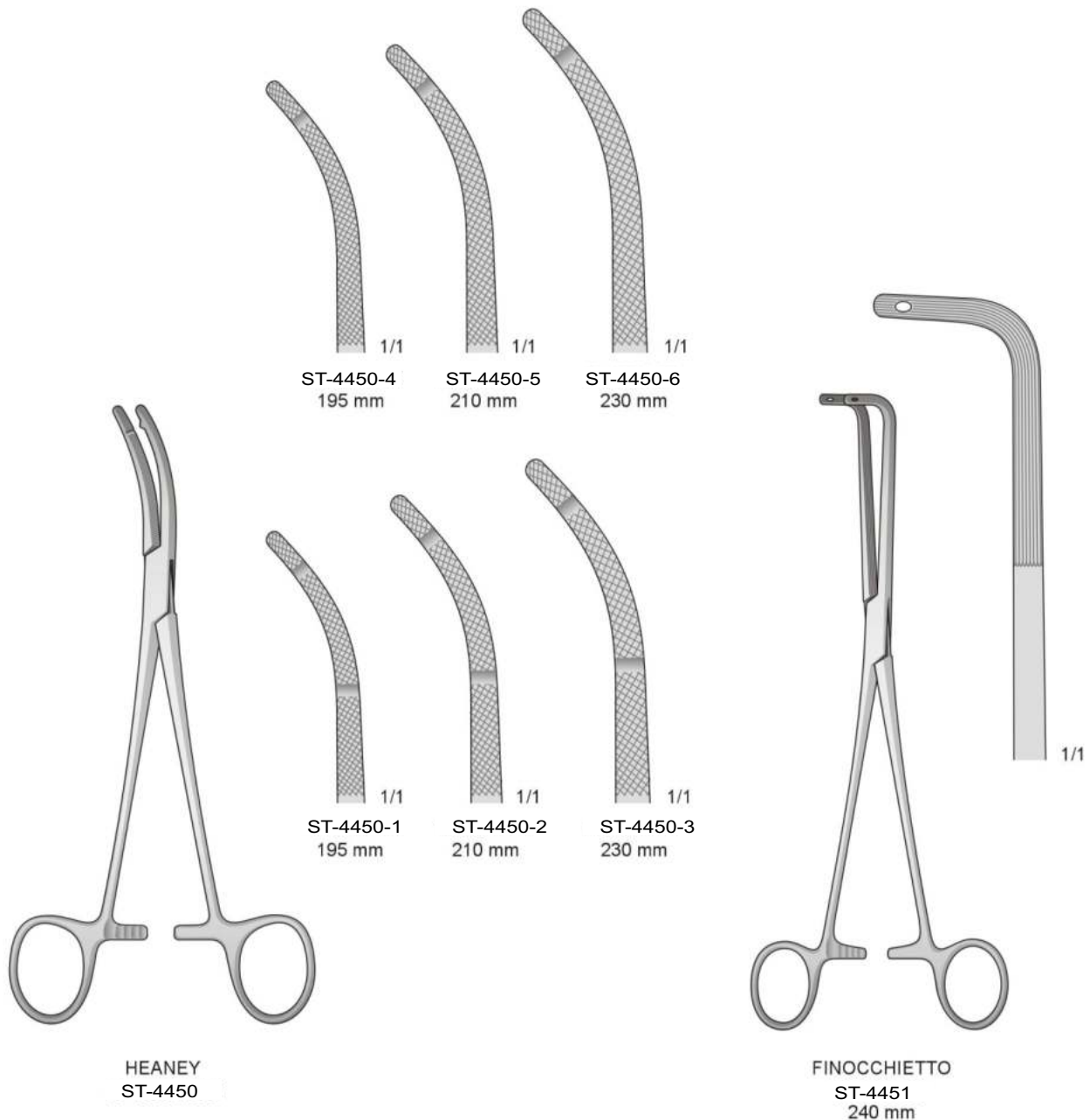
WERTHEIM
ST-4448
230 mm

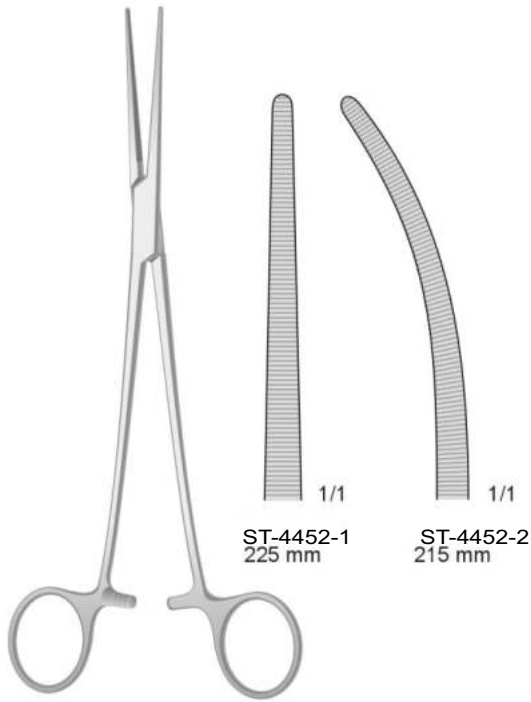


ST-4449-1
230 mm

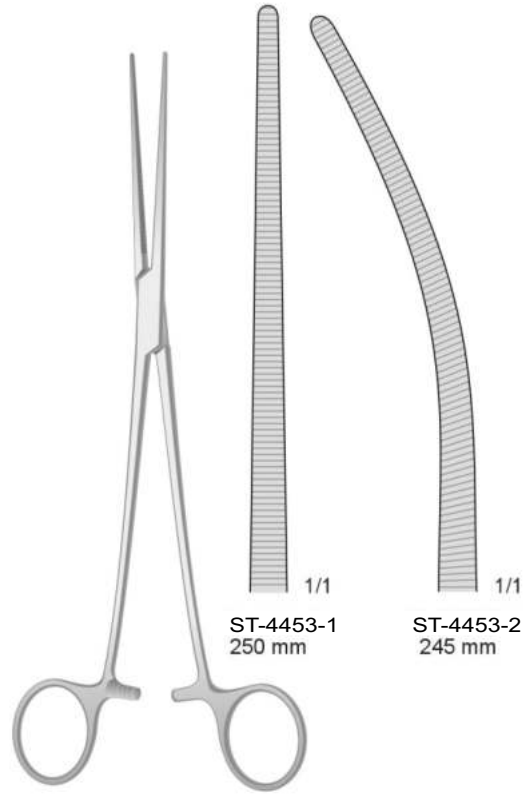
ST-4449-2
230 mm

WERTHEIM
ST-4449
230 mm

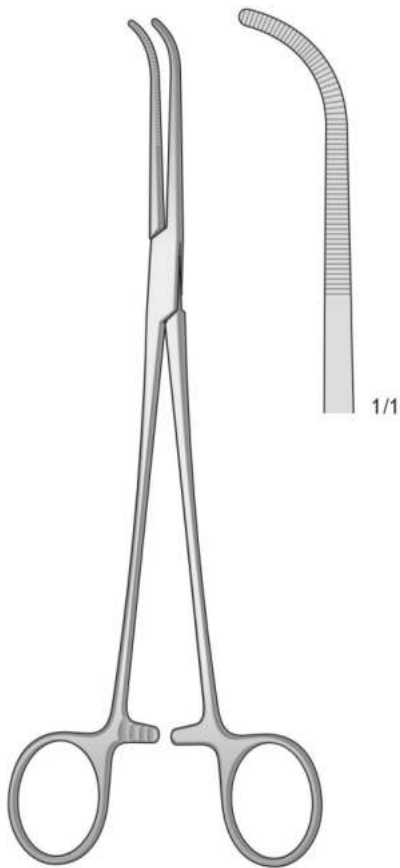




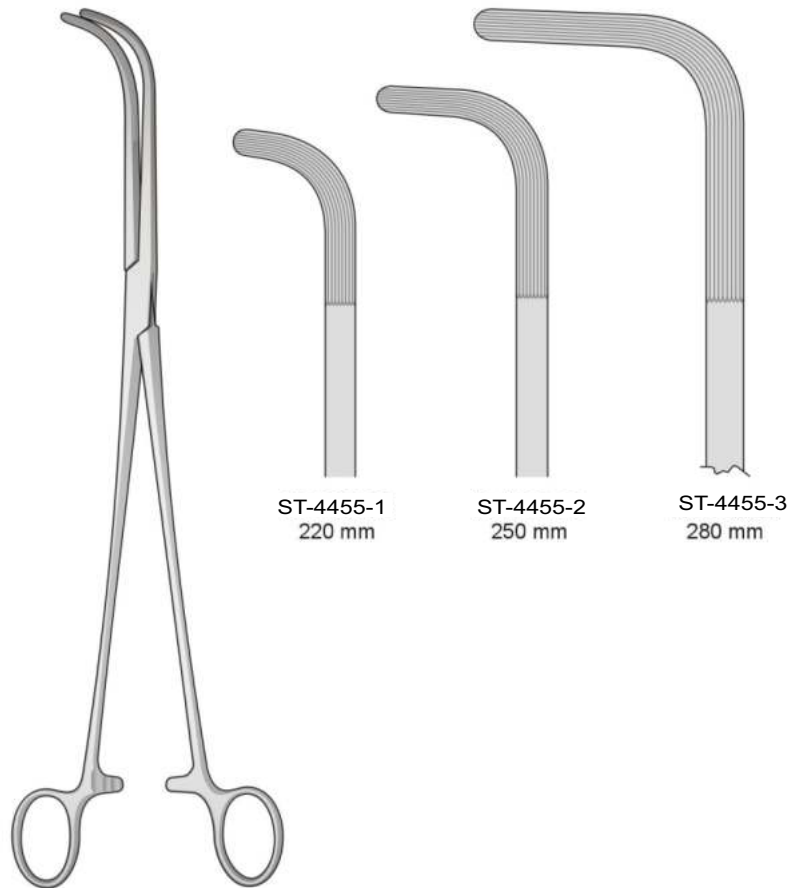
ROBERTS
ST-4452



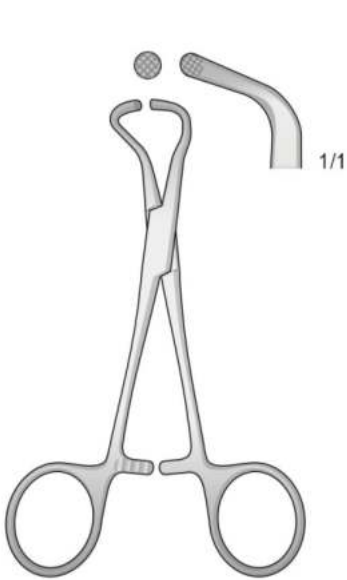
SAROT
ST-4453



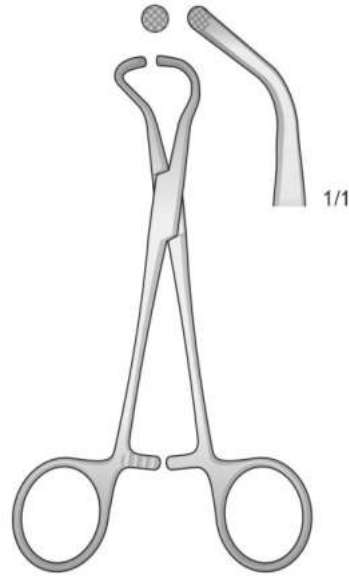
MIXTER
ST-4454
225 mm



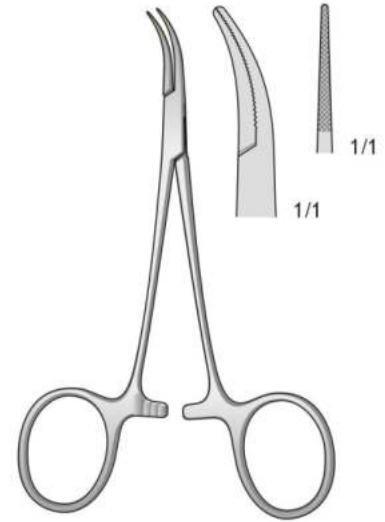
MIXTER
ST-4455



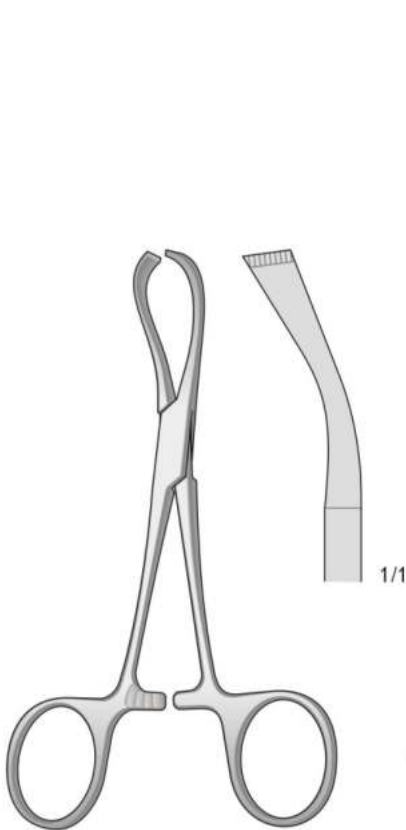
ST-4456
100 mm



ST-4457
125 mm



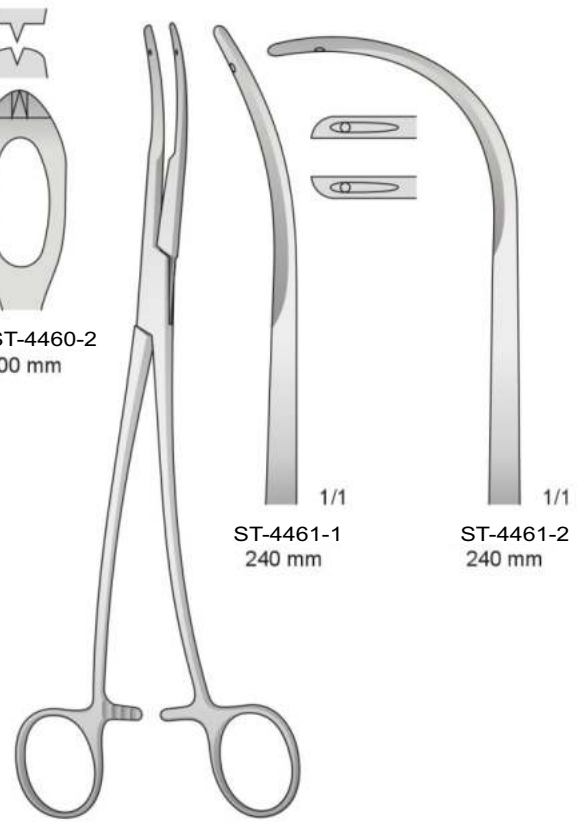
DANDY-MOSQUITO
ST-4458
120 mm



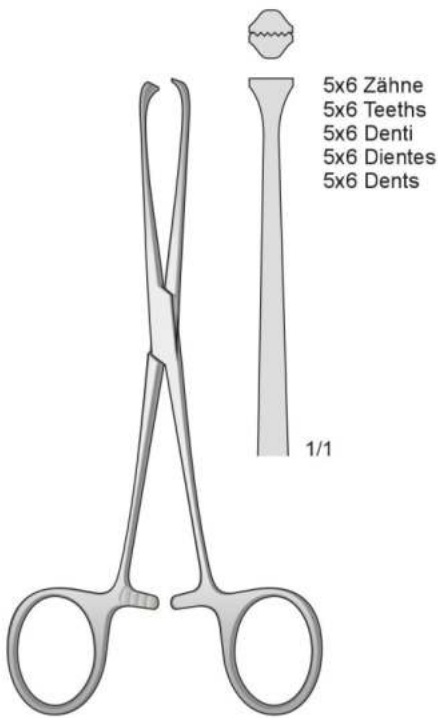
LORNA
ST-4459
130 mm



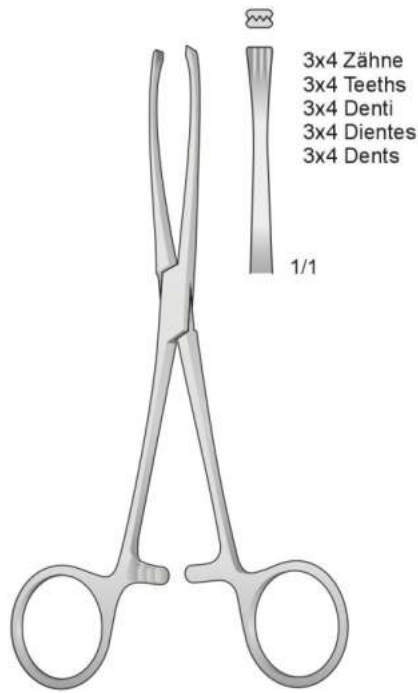
LANE
ST-4460



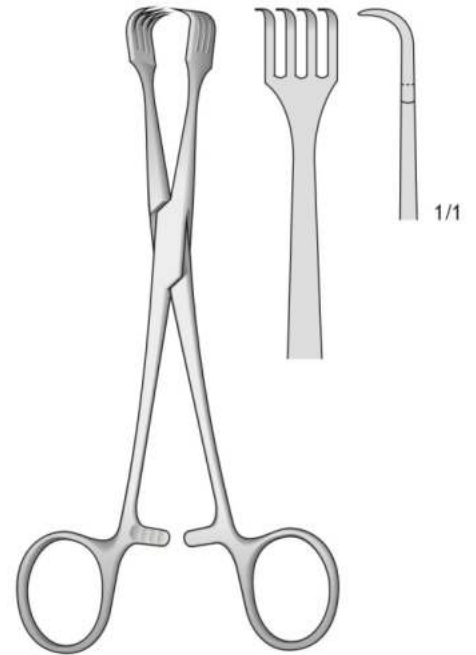
SEMB
ST-4461
240 mm



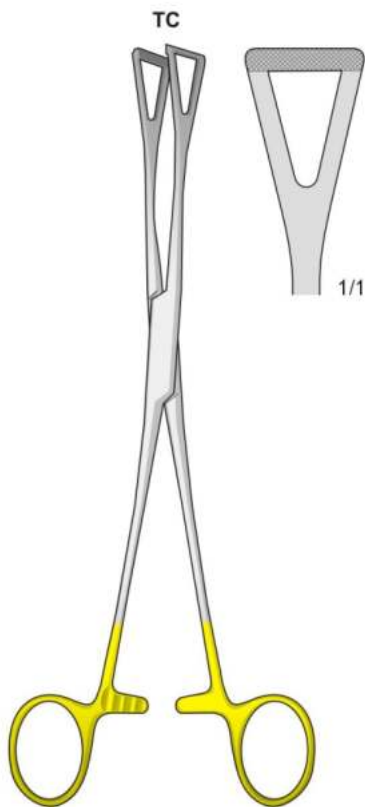
BOYS-ALLIS
ST-4462
150 mm



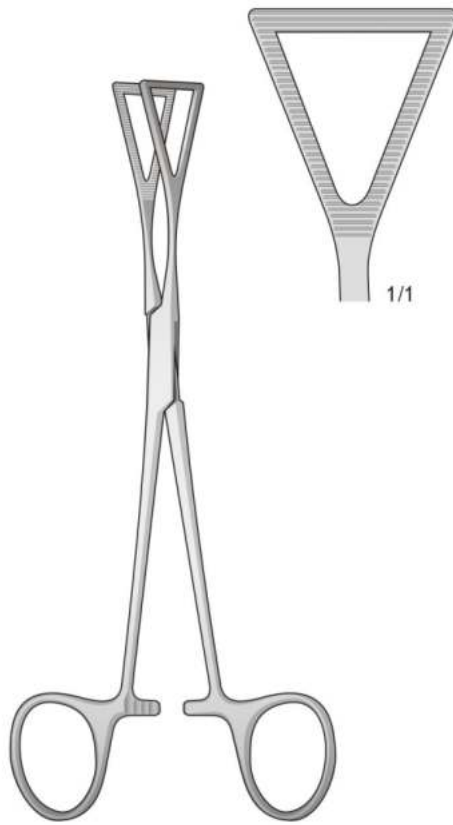
JUDD-ALLIS
ST-4463
155 mm



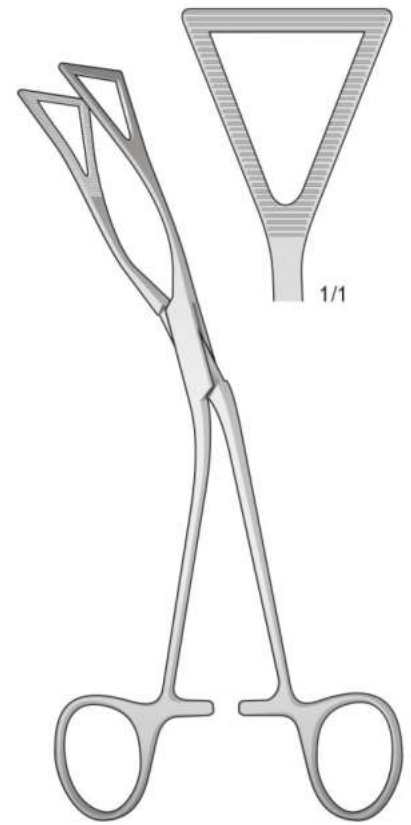
BRAUN
ST-4464
155 mm



DUVAL
ST-4465
200 mm



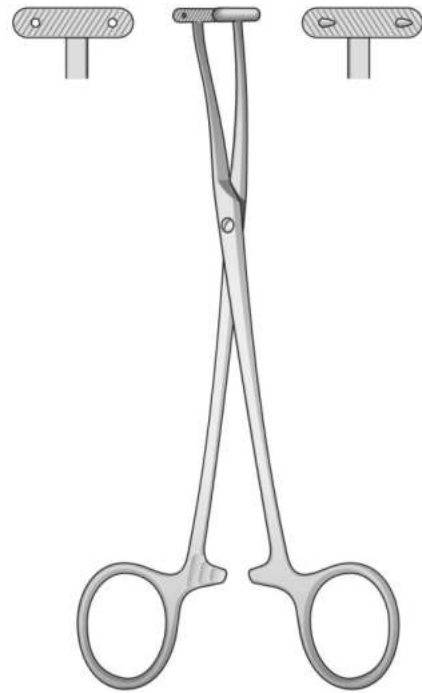
LOVELACE
ST-4466
200 mm



LOVELACE
ST-4467
200 mm



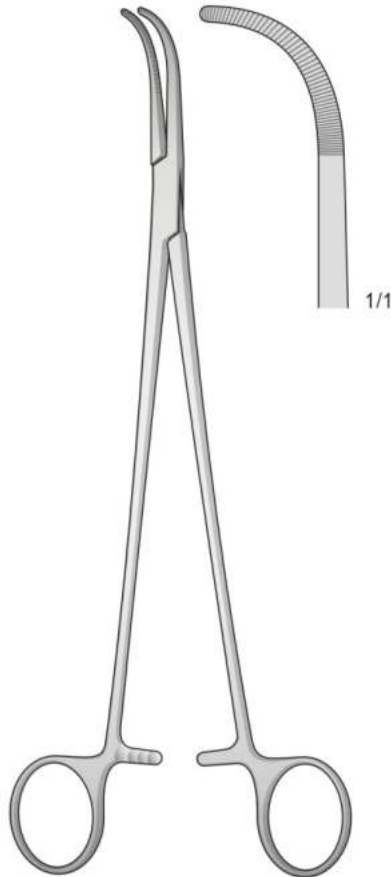
PEET
ST-4468
120 mm



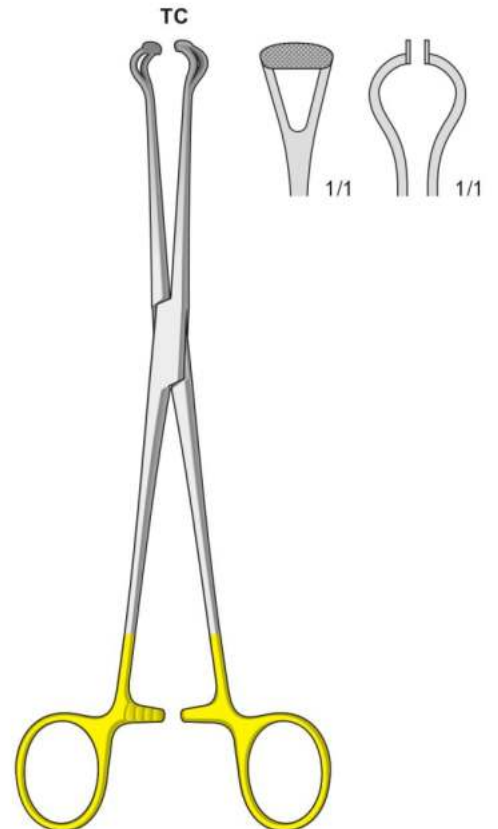
DE MARTEL
ST-4469
180 mm



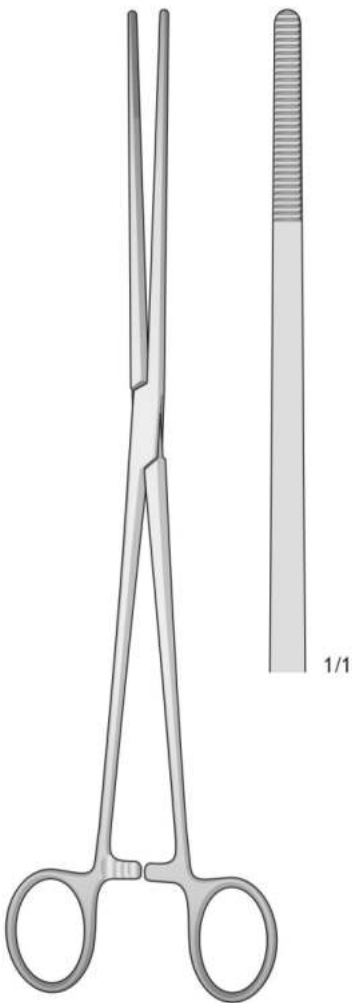
MIXTER
ST-4470
220 mm



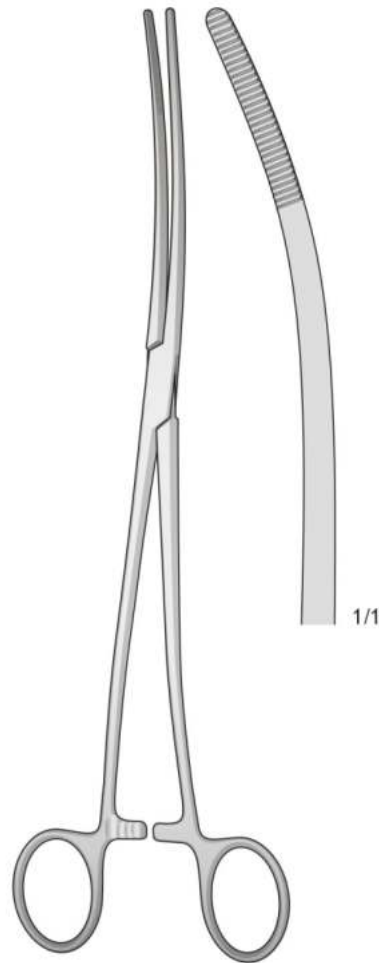
MIXTER
ST-4471
230 mm



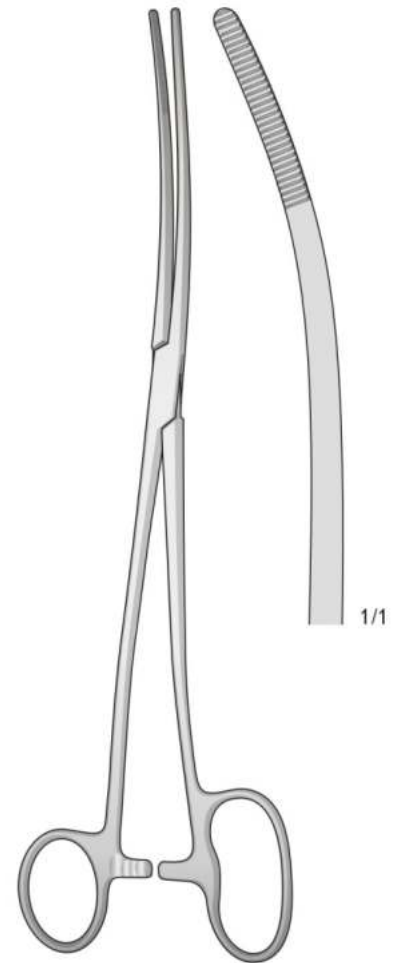
BABCOCK
ST-4472
210 mm



BOZEMANN
ST-4473
260 mm



BOZEMANN
ST-4474
260 mm



BOZEMANN-DOUGLAS
ST-4475
260 mm



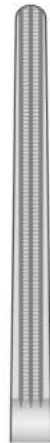
De BAKEY

Atraumatiche



De BAKEY

Atraumatiche



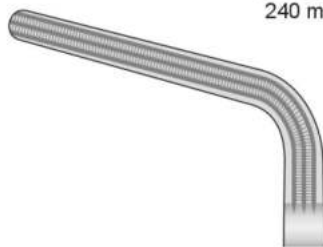
ST-4477-1
250 mm



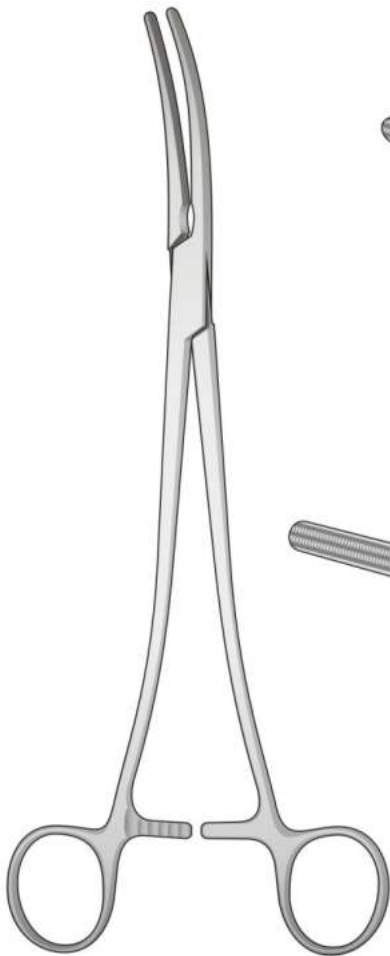
18-1900-02
ST-4477-2



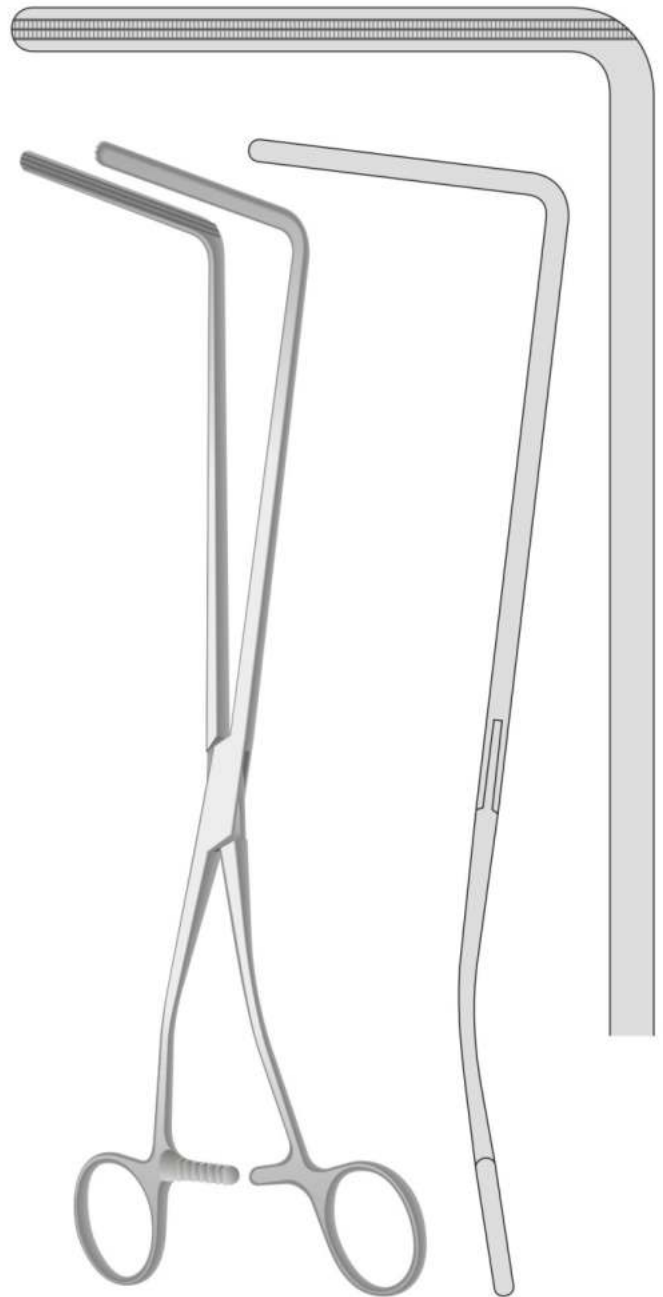
ST-4477-3
240 mm



ST-4477-4
230 mm



ST-4477
WERTHEIM



RESANO
ST-4476
280 mm

1/1

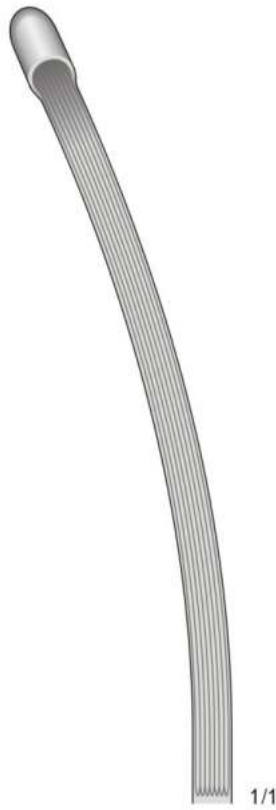


Weich und elastisch
With soft and
elastic blades



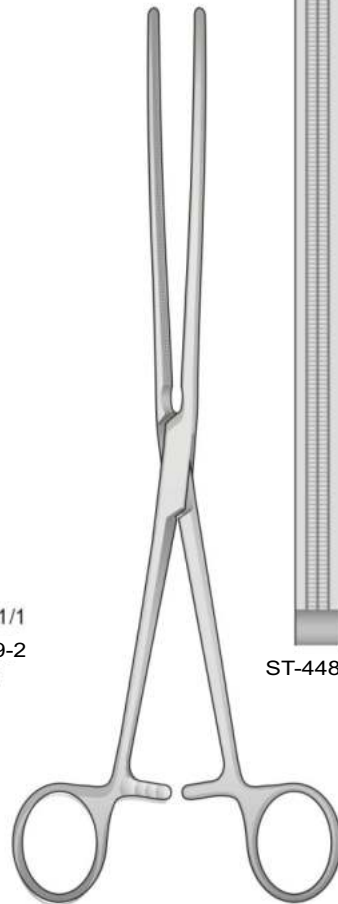
ST-4479-1
250 mm

NUSSBAUM
ST-4479
250 mm



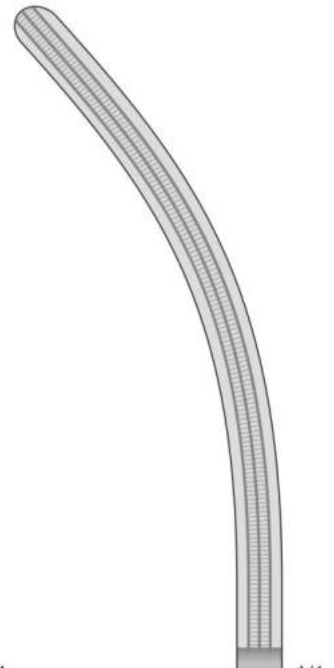
ST-4479-2
250 mm

Atrauma

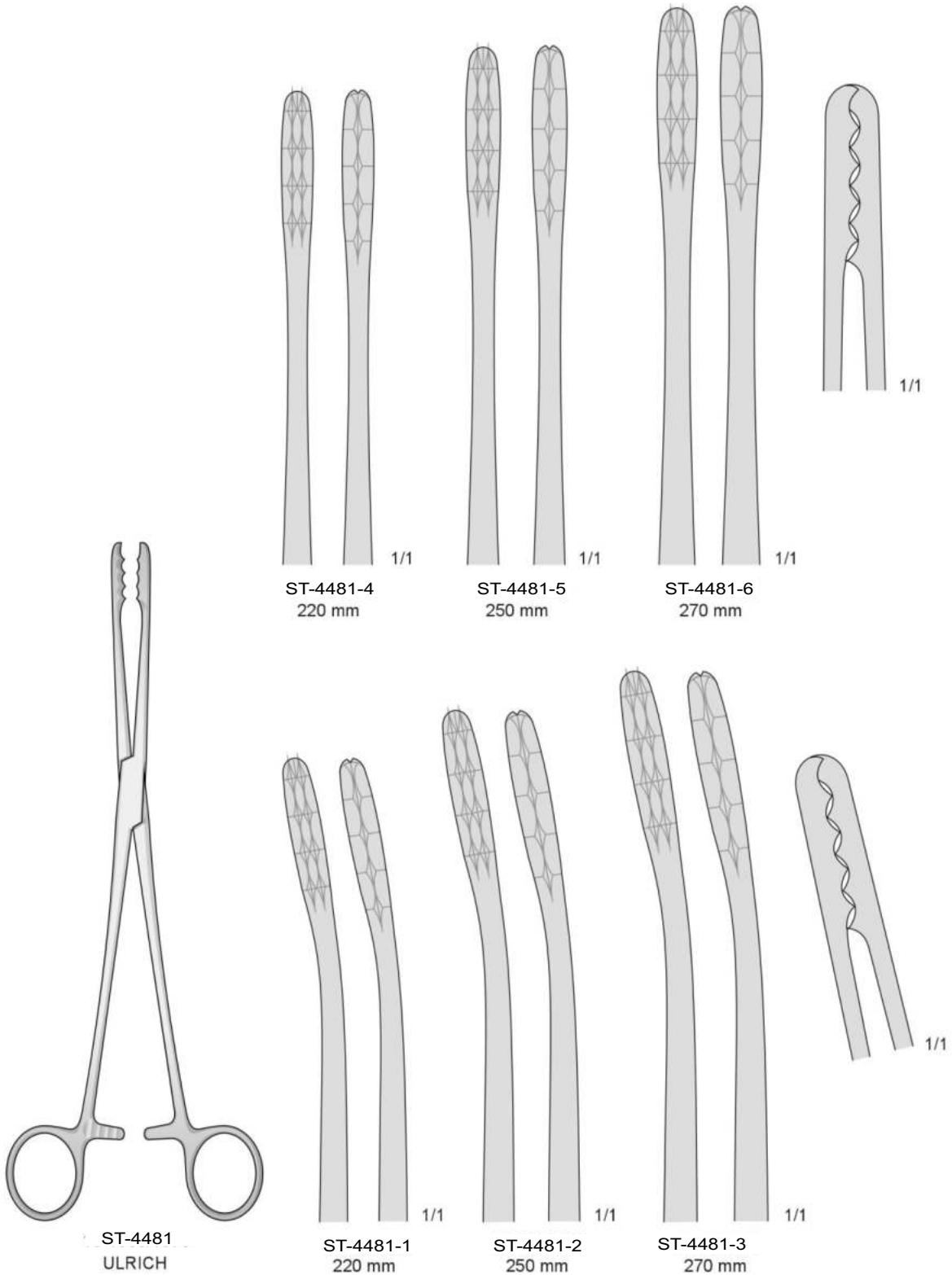


ST-4480-1

DOYEN
ST-4480
230 mm

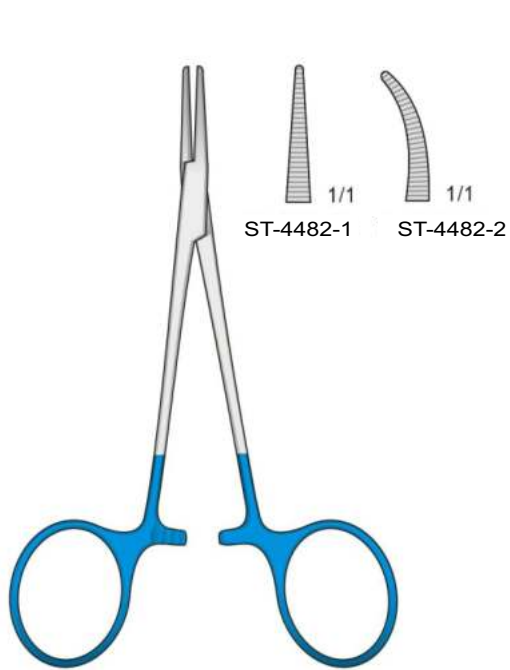


ST-4480-2

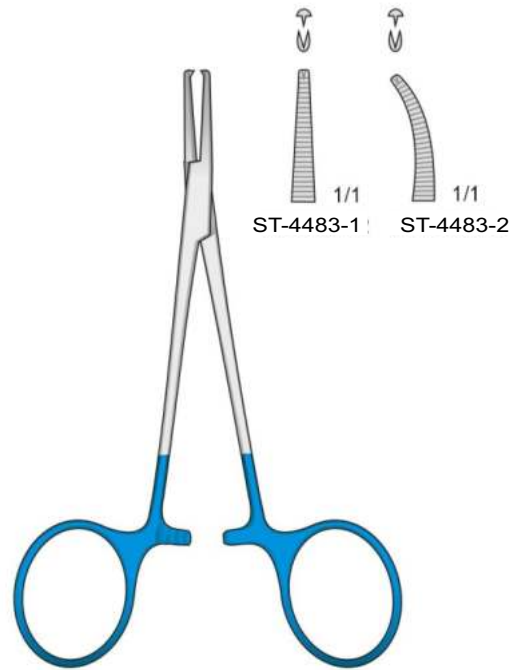




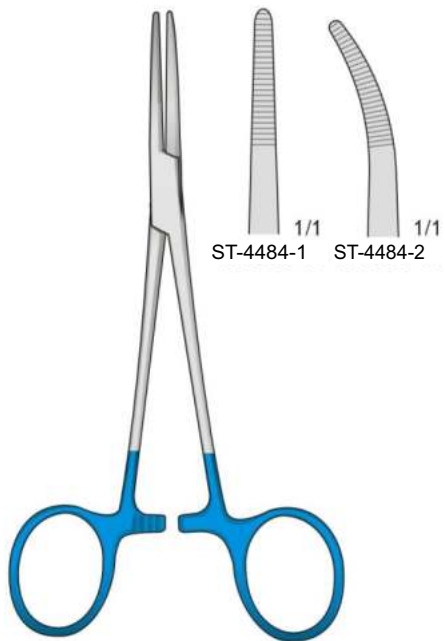
Titan - Titanium - Titanio - Titane



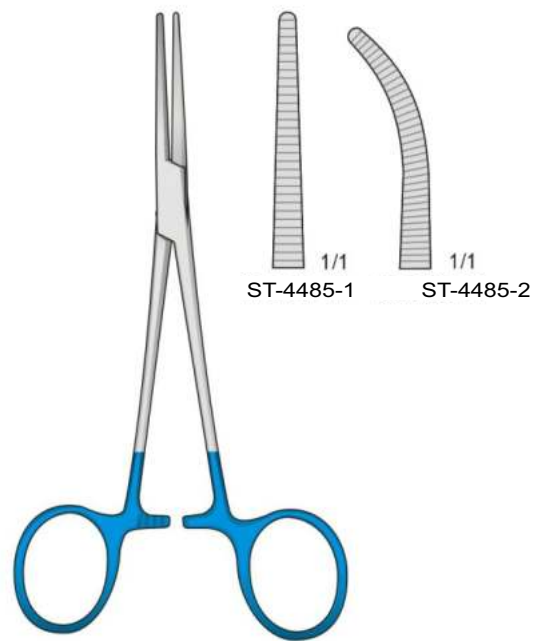
HALSTED-MOSQUITO
ST-4482
120 mm



HALSTED-MOSQUITO
ST-4483
120 mm



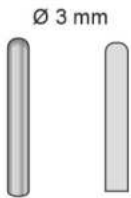
KELLY
ST-4484
140 mm



CRILE
ST-4485
140 mm

18-2060
 Krampfaderbesteck komplett
 Varicose Vein Probe Set complete
 Set completo sonda per varici
 Juego para varices completo
 Trousse à varices complète

Metall-Sondenspitzen
 Probe tip, metal
 Punta per sonda
 in metallo
 Punta metálica
 Pointe en métal



ST-4486



ST-4487

Oliven - Olives - Olive - Oliva - Olive



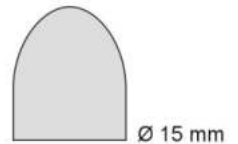
ST-4487-1



ST-4487-2



ST-4487-3



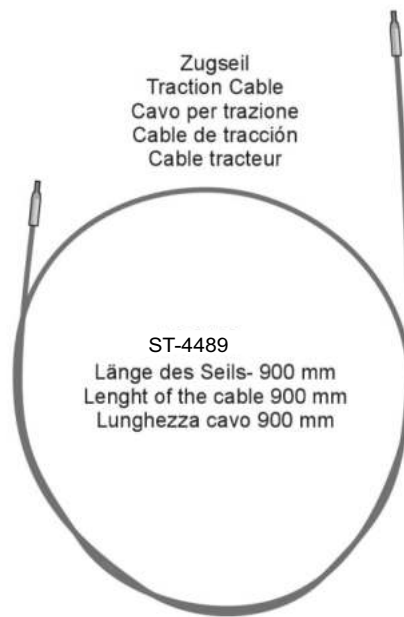
ST-4487-4

Griff Allein
 Handle only
 Manico solo
 Mango solo
 Manche seule

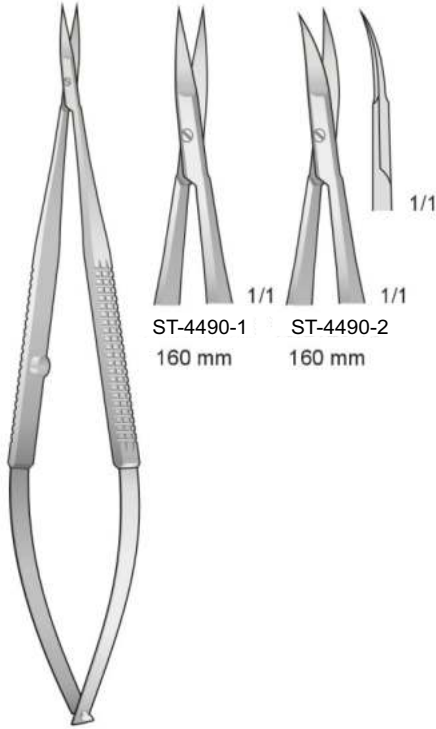


ST-4488

Zugseil
 Traction Cable
 Cavo per trazione
 Cable de tracción
 Cable tracteur



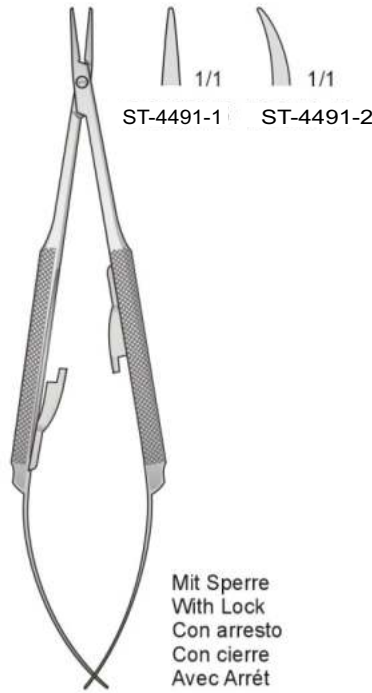
ST-4489
 Länge des Seils- 900 mm
 Length of the cable 900 mm
 Lunghezza cavo 900 mm



ST-4490
160 mm

ST-4490-1
160 mm

ST-4490-2
160 mm



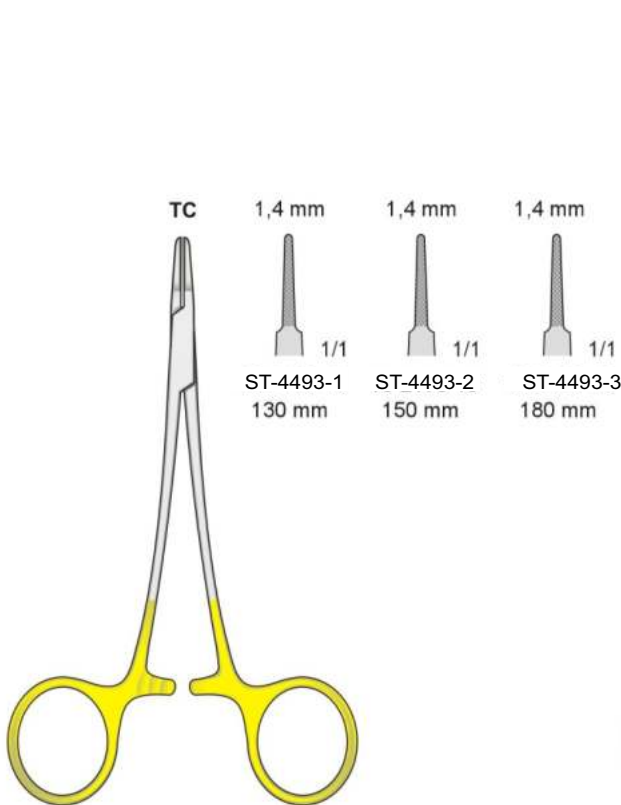
BARRAQUER
ST-4491
150 mm

Mit Sperre
With Lock
Con arresto
Con cierre
Avec Arrêt

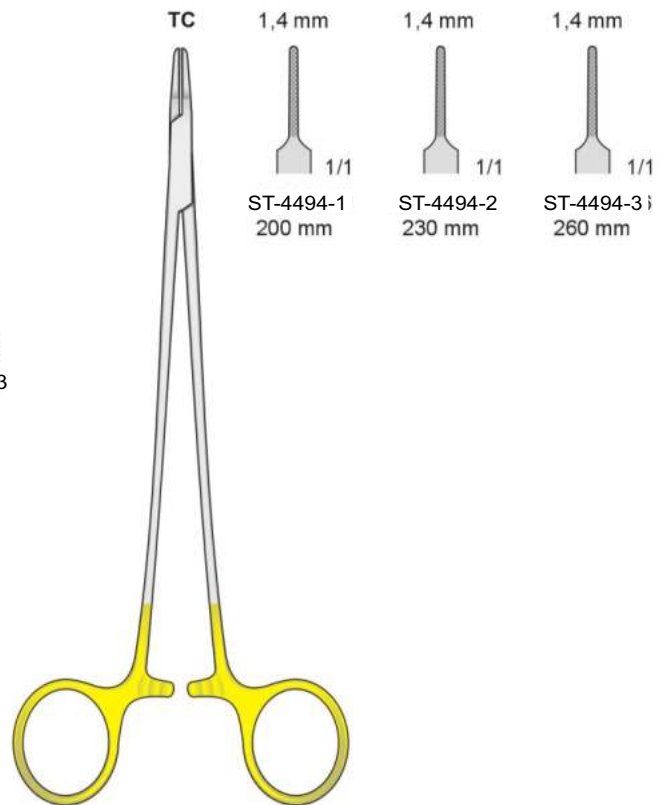


CASTROVIEJO
ST-4492
140 mm

Nadelhalter mit Hartmetalleinlagen - Needle Holders with tungsten-carbide inserts
Portaghi con inserti al tungsteno - Portaagujas con plaquitas de carburo de tungsteno
Porte aiguilles avec plaquettes en carbure de tungstène



MICRO-RYDER
ST-4493

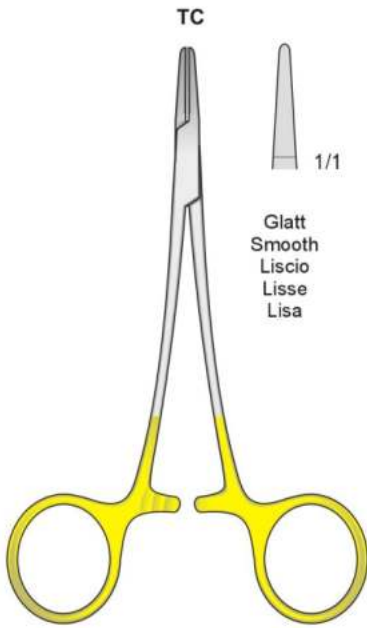


MICRO-RYDER
ST-4494



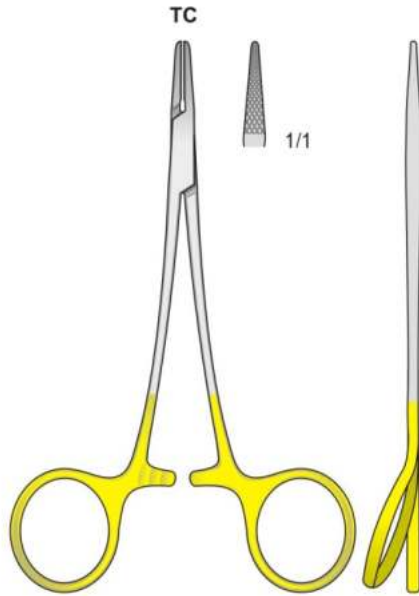
Nadelhalter mit Hartmetalleinlagen - Needle Holders with tungsten-carbide inserts - Portaghi con inserti al tungsteno
Portaagujas con plaquitas de carburo de tungsteno - Porte aiguilles avec plaquettes en carbure de tungstène

Ein Ring abgewinkelt
One ring angled
Un anello angolato

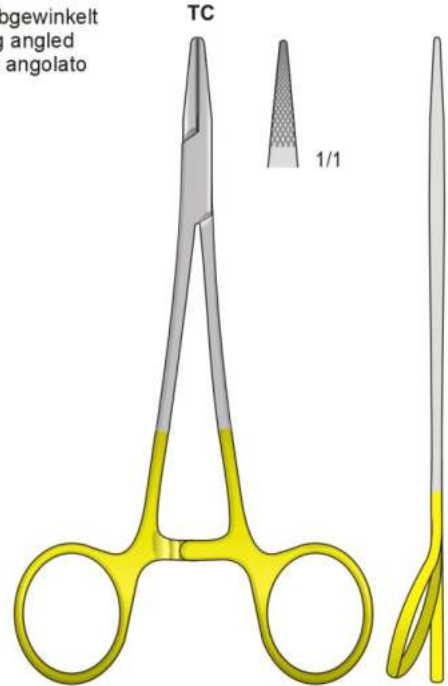


HALSEY
ST-4495
130 mm

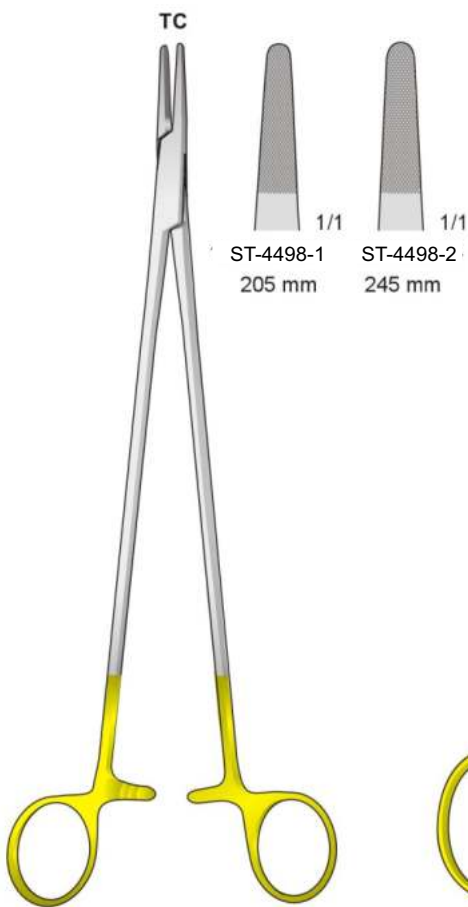
Glatt
Smooth
Liscio
Lisse
Lisa



ST-4496
120 mm



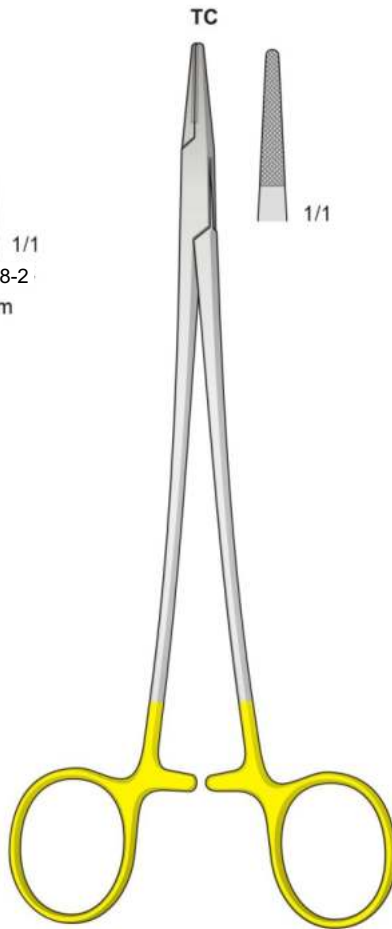
CRILE-WOOD
ST-4497
150 mm



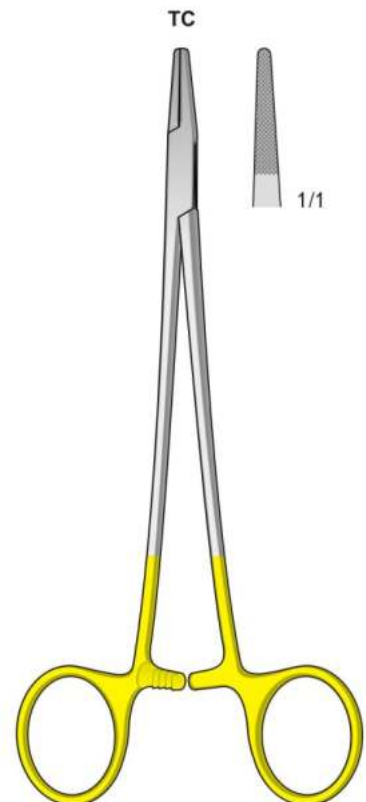
HEGAR
ST-4498

ST-4498-1
205 mm

ST-4498-2
245 mm

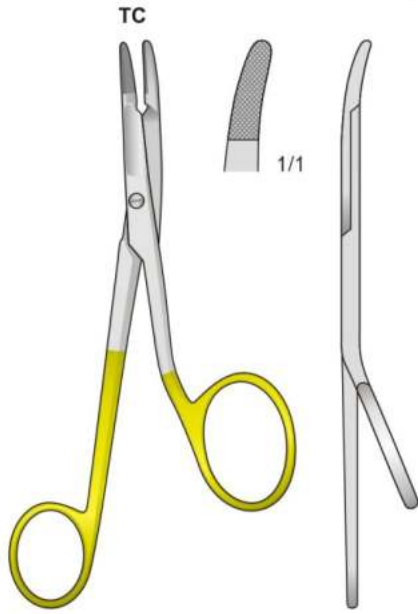


DE BAKEY
ST-4499
370 mm

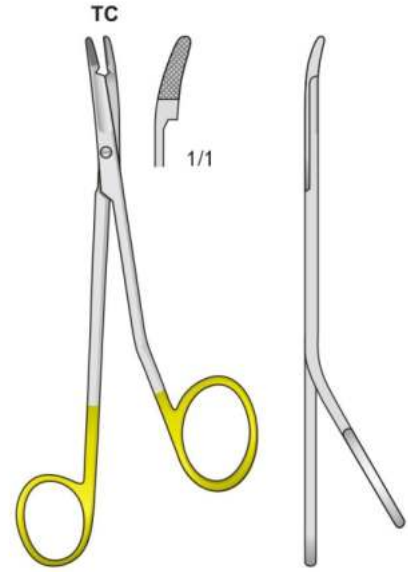


DeBAKEY
ST-4500
200 mm

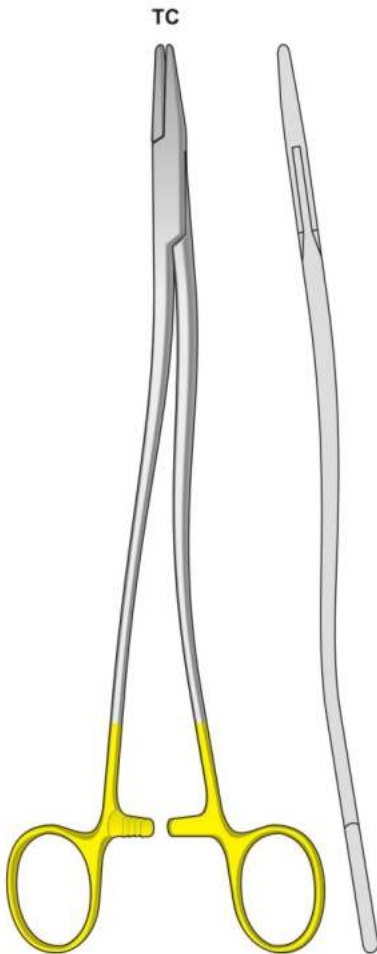
Für Linkshänder - Left Handed
Per mancini - Pour gauche - Para zurdos



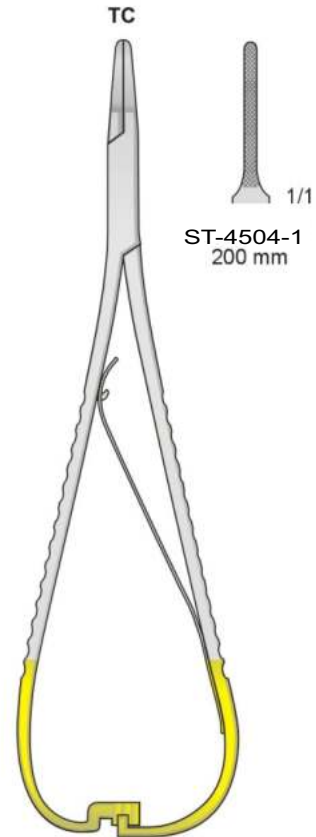
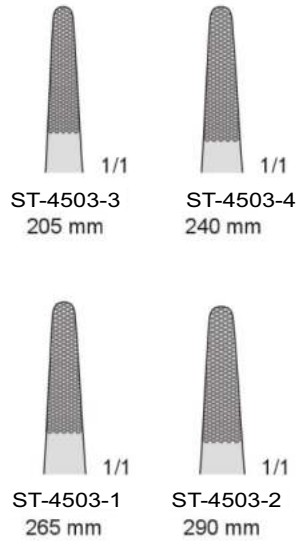
GILLIES
ST-4501
160 mm



MINI-GILLIES
ST-4502
145 mm



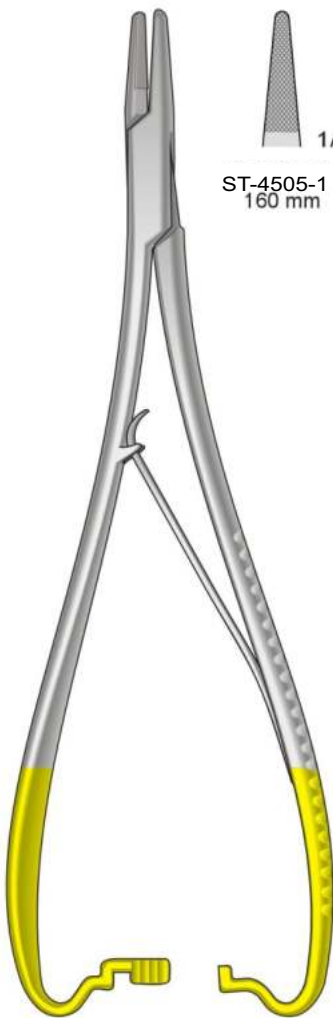
BOZEMANN
ST-4503



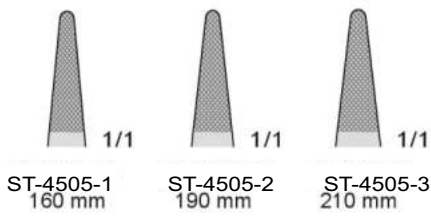
LICHTENBERG
ST-4504
175 mm

Kräftiges Modell
Heavy pattern
Modello robusto
Modèle robuste

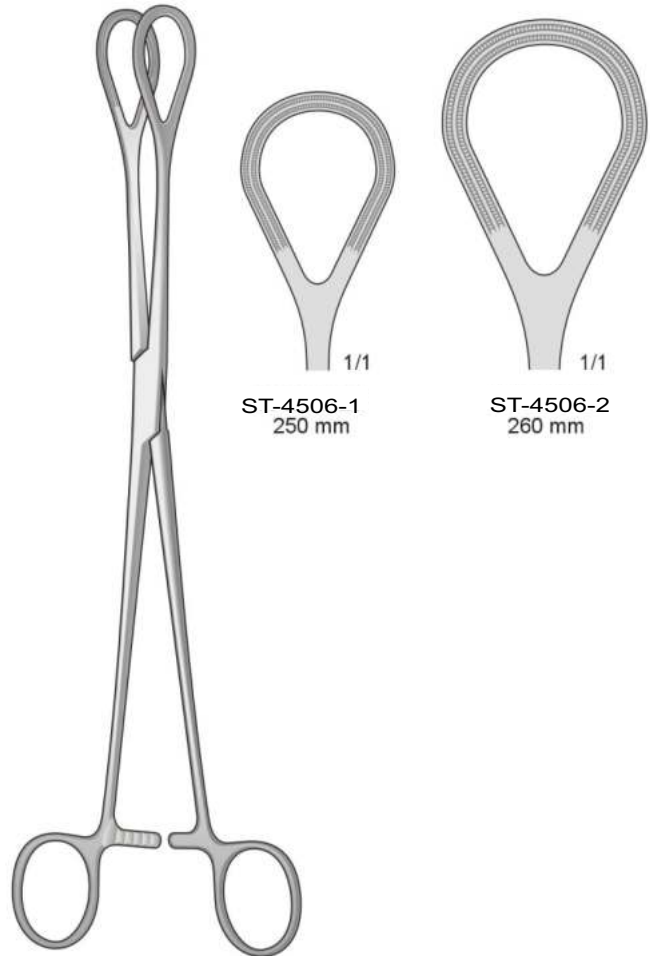
TC



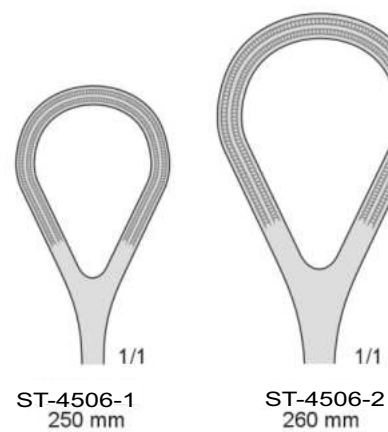
MATHIEU
ST-4505



Atraumatische - Atraumatic
Atraumatiche - Atraumáticas
Atraumatique

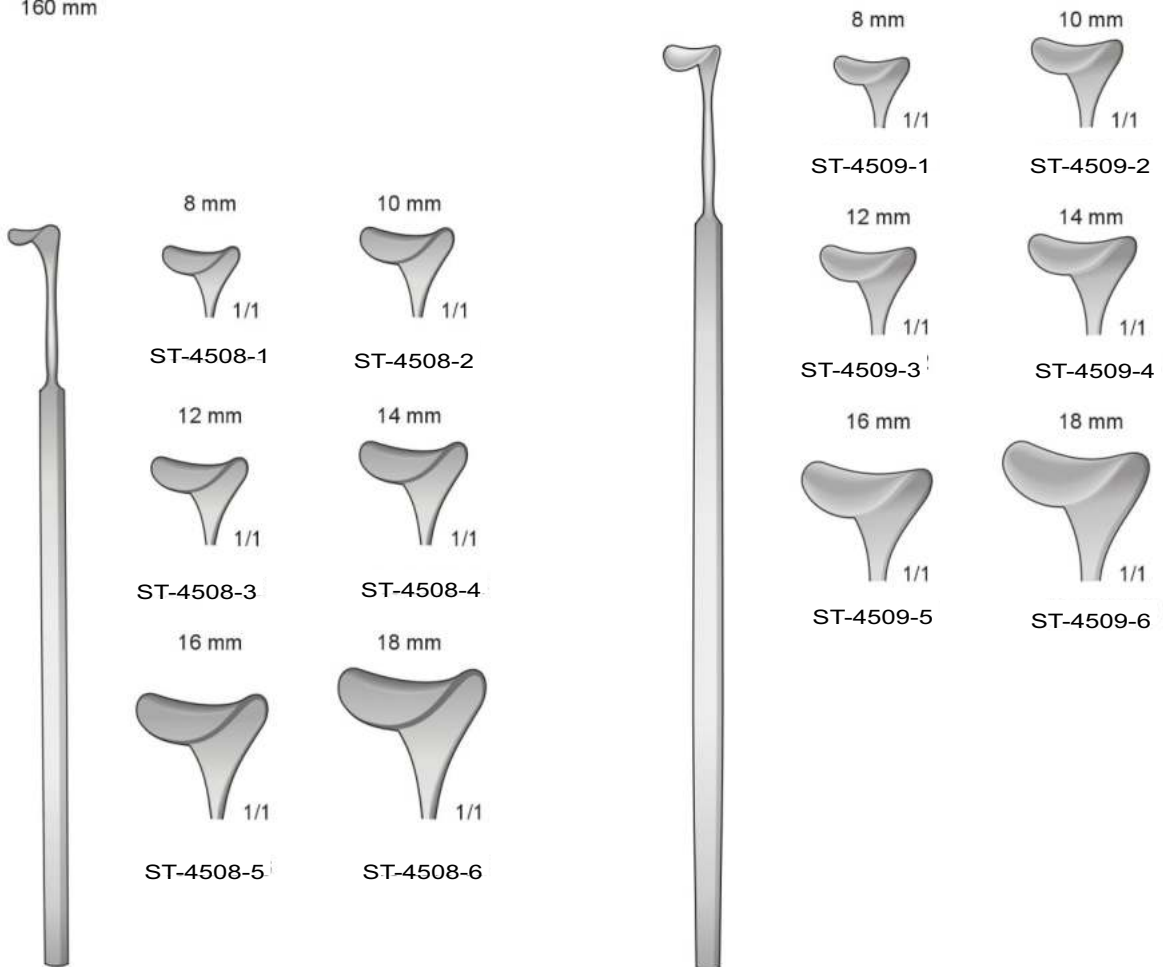


ST-4506



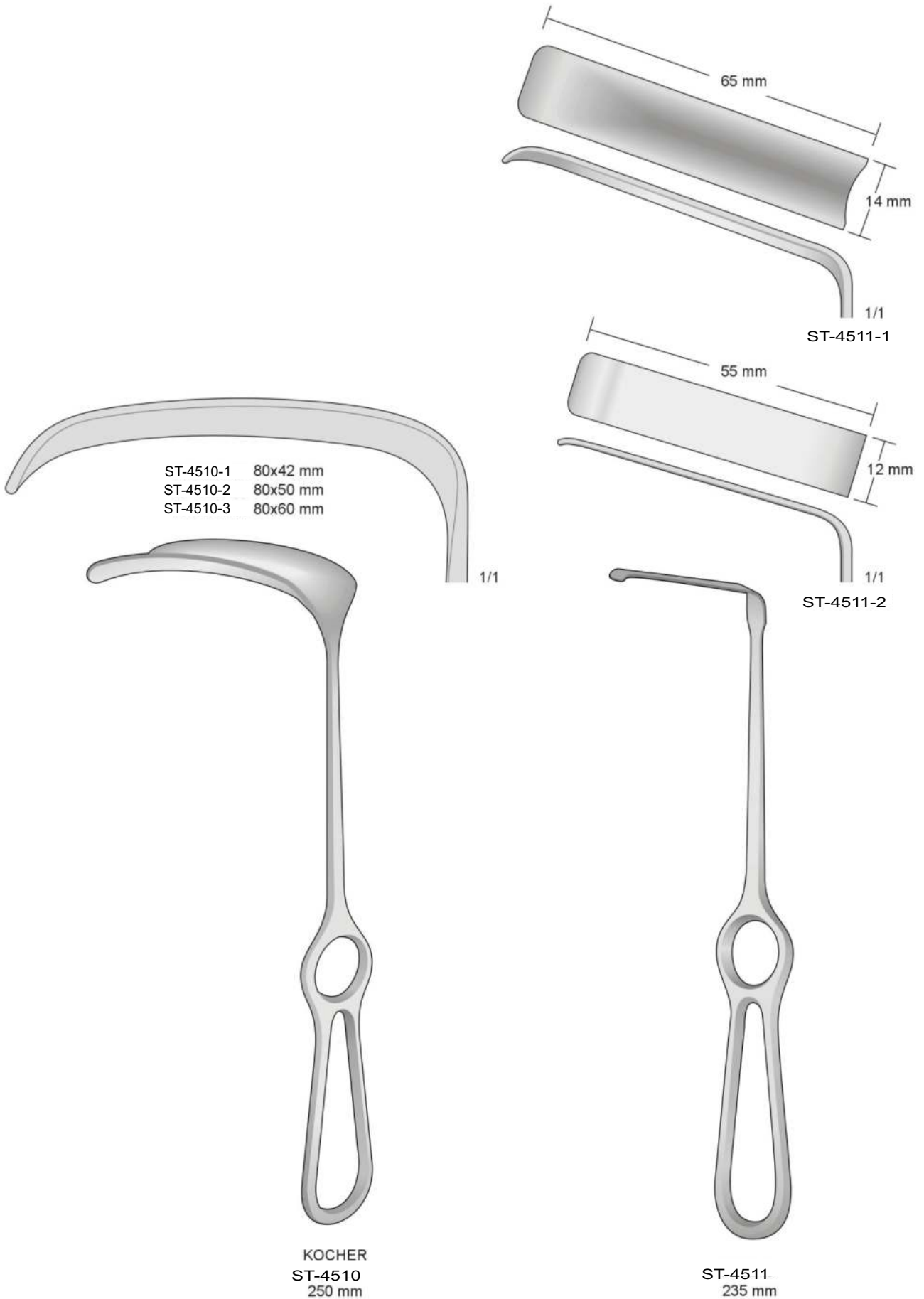


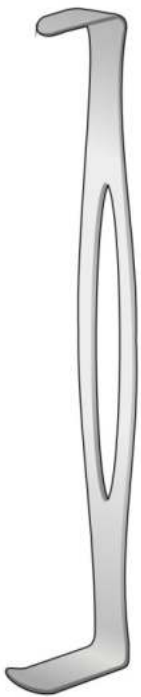
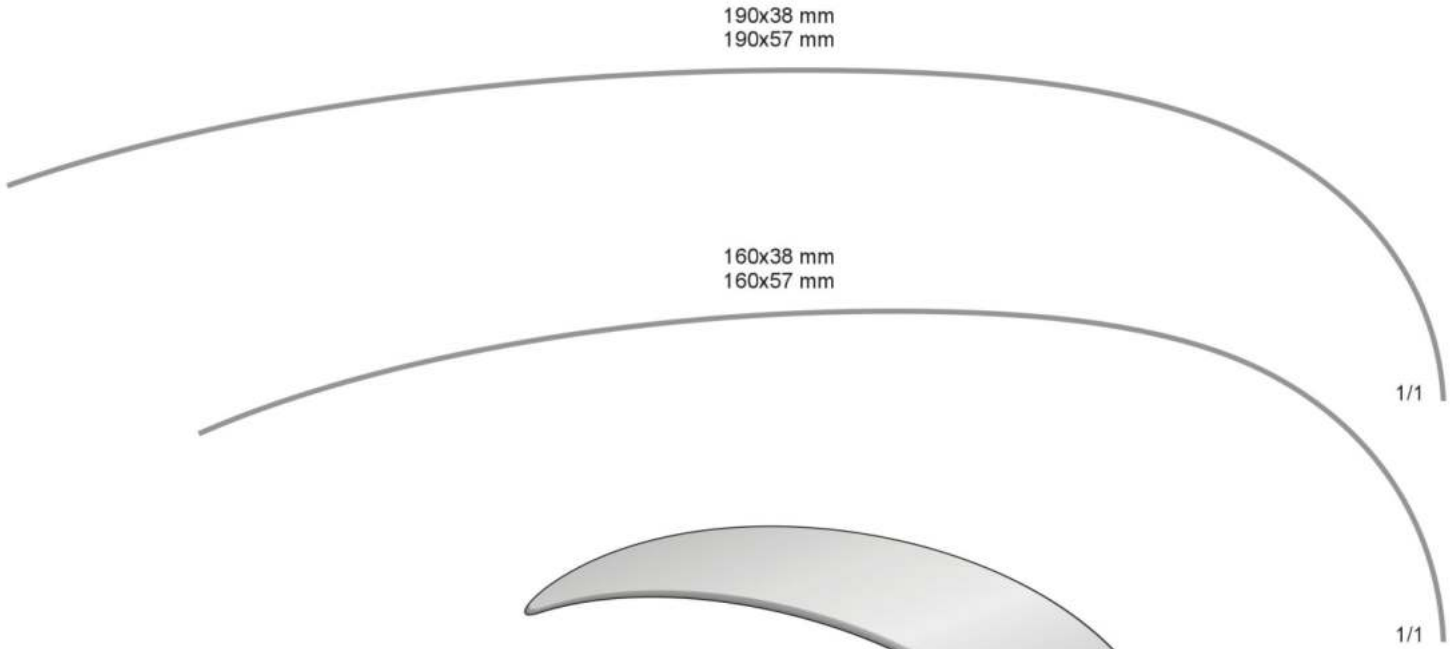
MINI-LANGENBECK
ST-4507
160 mm



CUSHING
ST-4508
200 mm

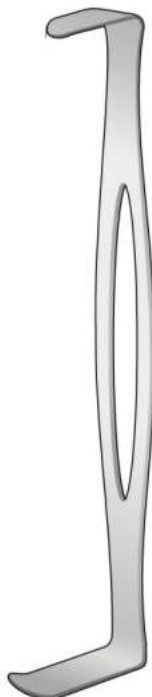
CUSHING
ST-4509
240 mm





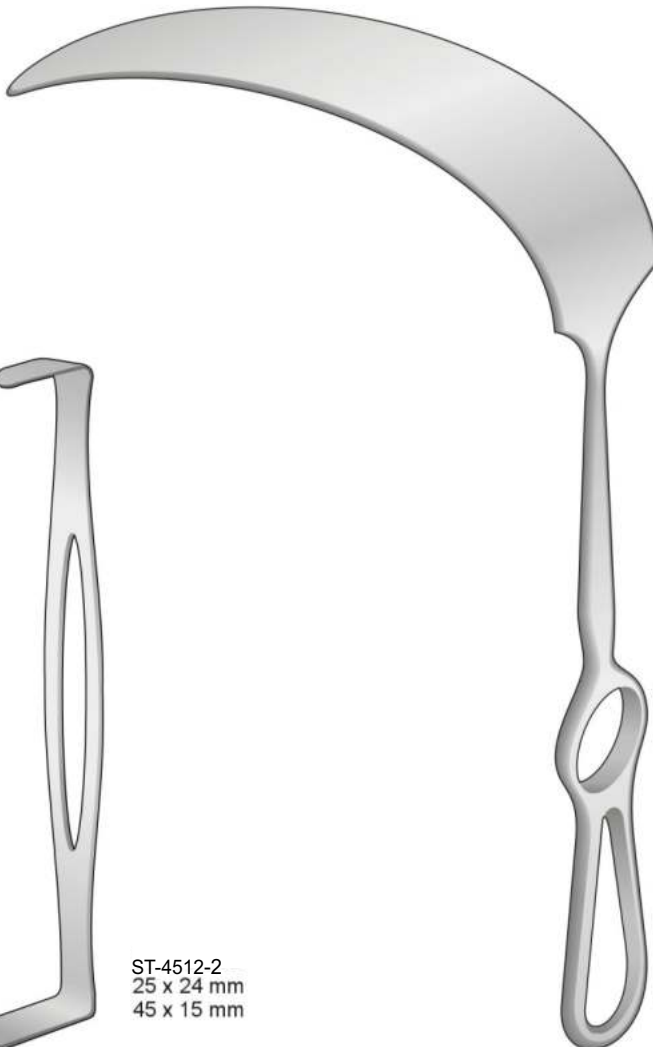
ST-4512-1
21 x 24 mm
40 x 15 mm

PARKER-LANGENBECK
ST-4512
210 mm



ST-4512-2
25 x 24 mm
45 x 15 mm

PARKER-LANGENBECK
ST-4512
210 mm



ST-4513-1 160x38 mm
ST-4513-2 160x57 mm
ST-4513-3 190x38 mm
ST-4513-4 190x57 mm

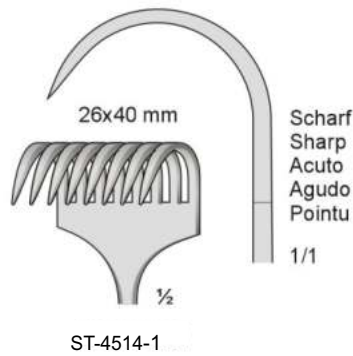
KELLY
ST-4513
270 mm



ST-4515-1 147x50 mm



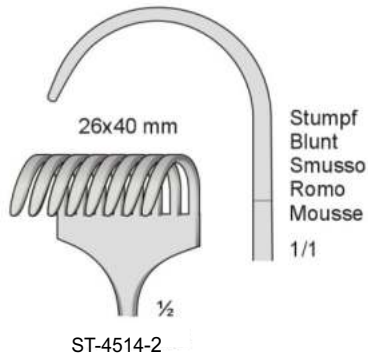
KÖRTE
ST-4514
240 mm



Scharf
Sharp
Acuto
Agudo
Pointu

1/1

ST-4514-1



Stumpf
Blunt
Smusso
Romo
Mousse

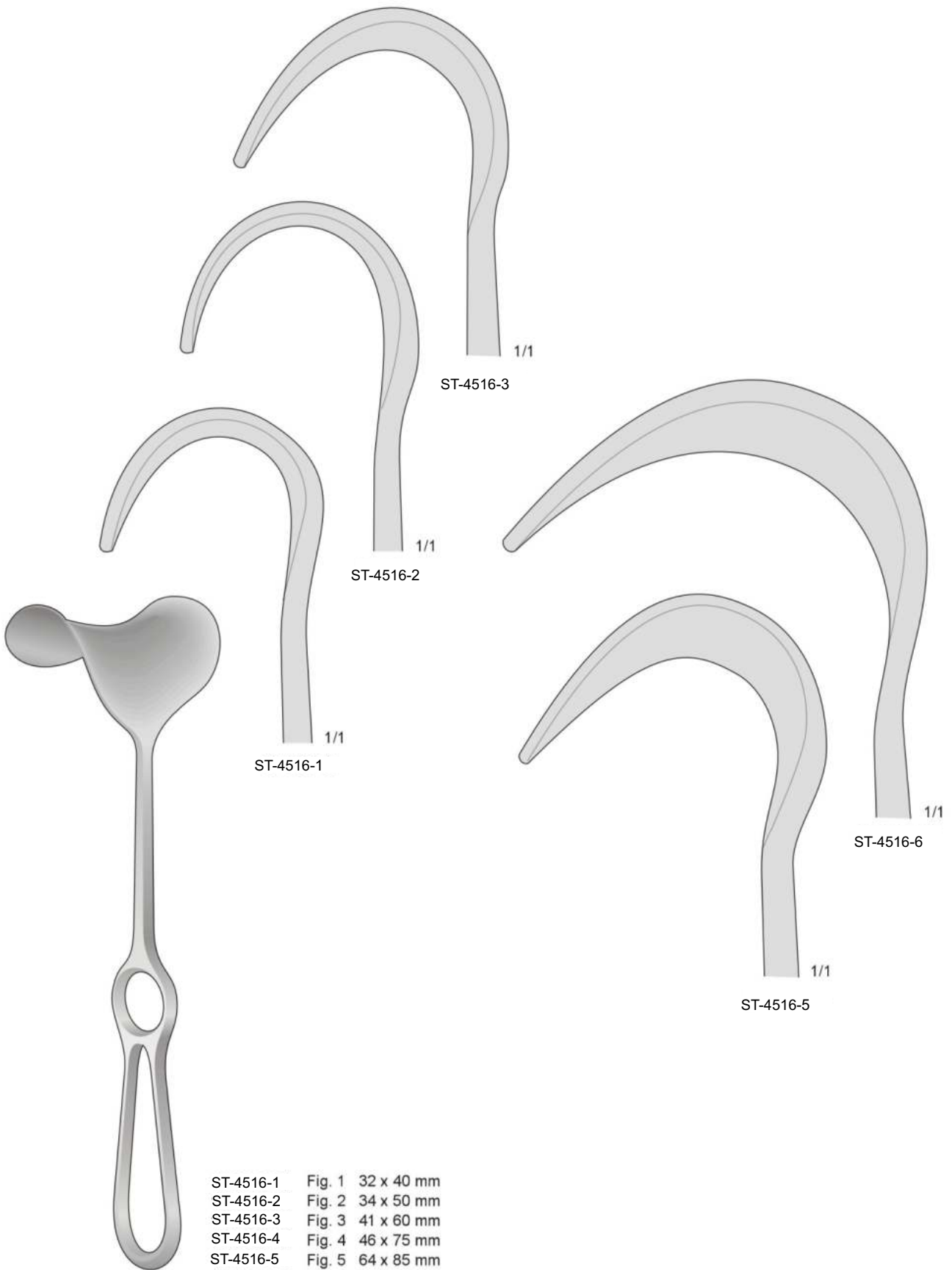
1/1

ST-4514-2



MIKULICZ
ST-4515
260 mm

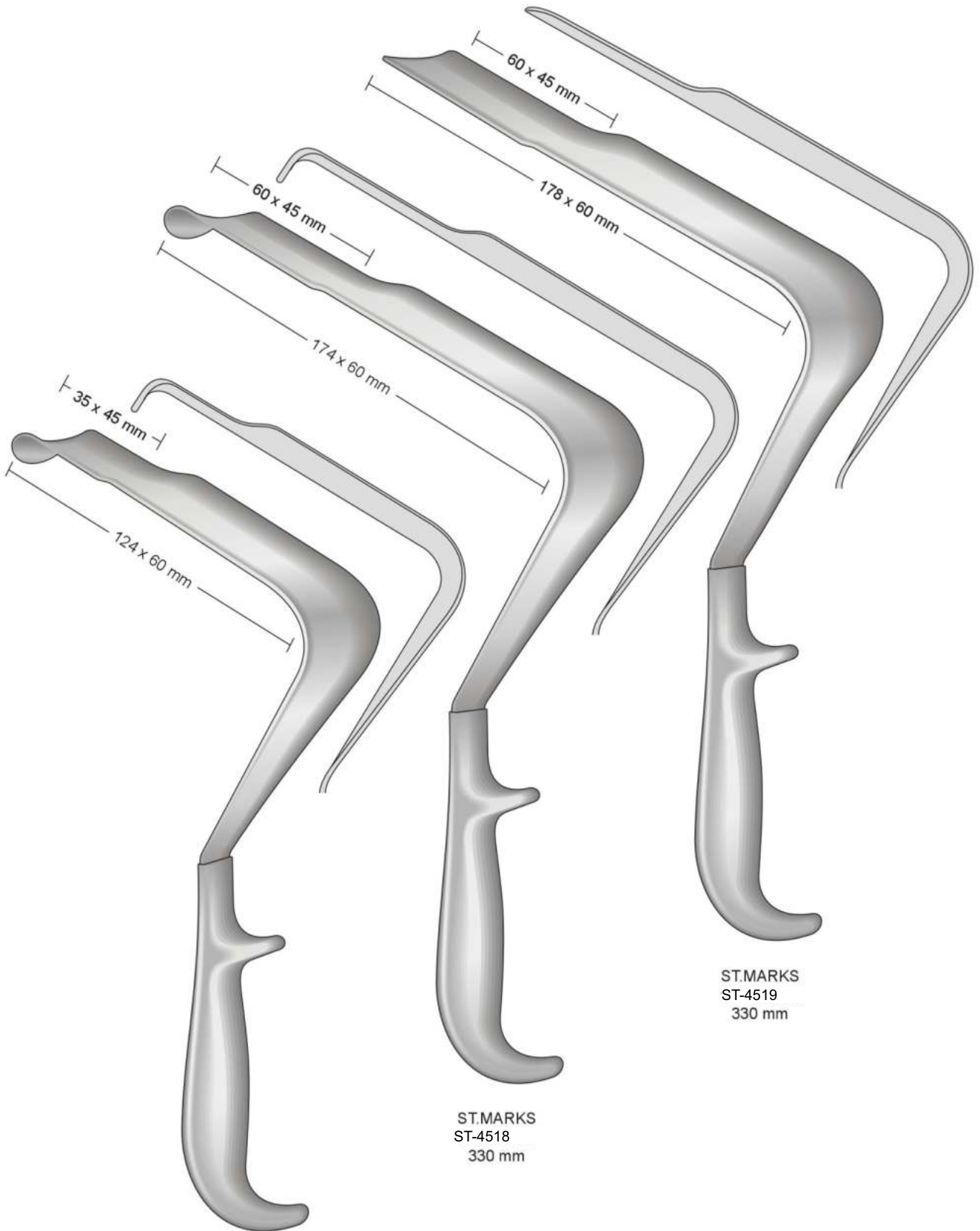
1/1



FRITSCH
ST-4516
240 mm



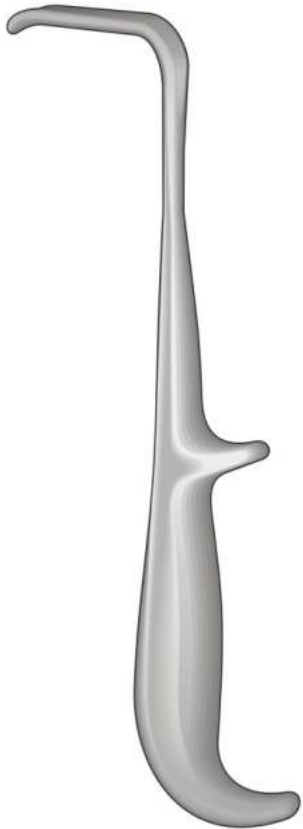
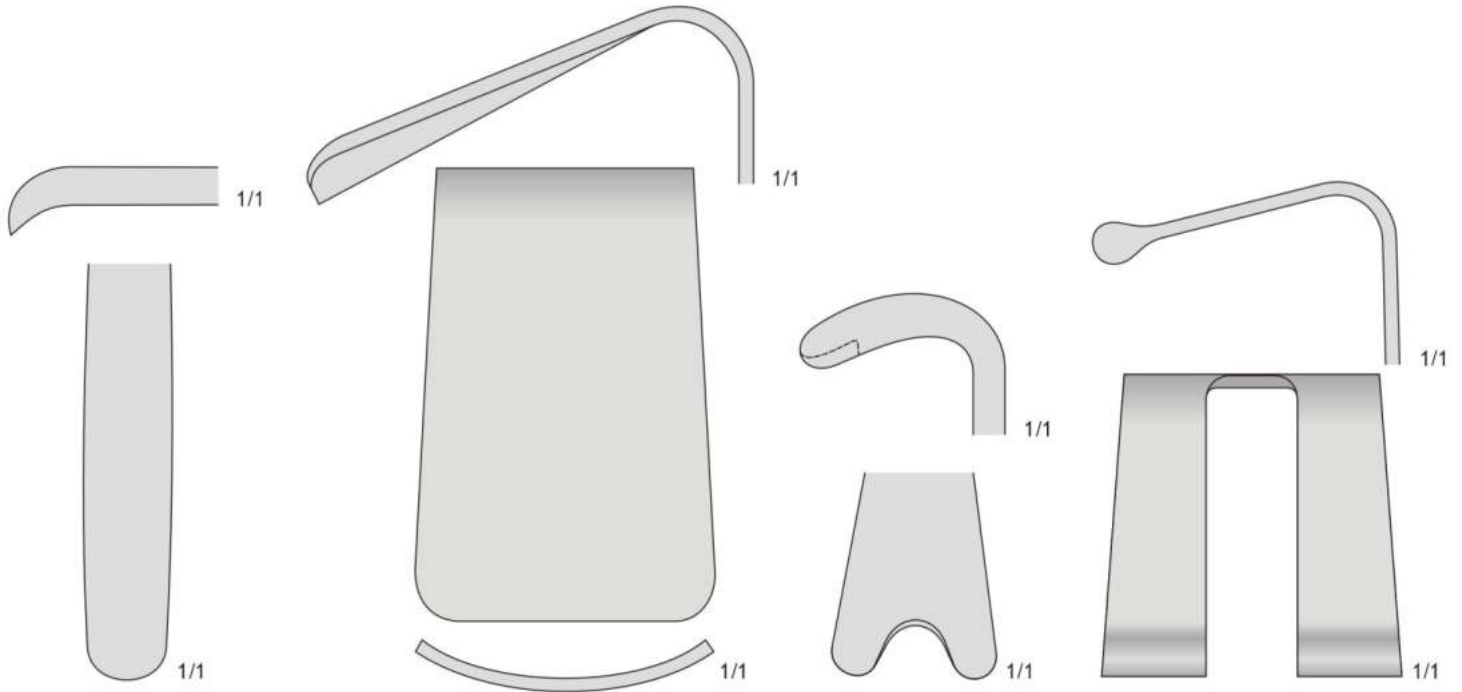
Pelvishaken
Pelvis retractors



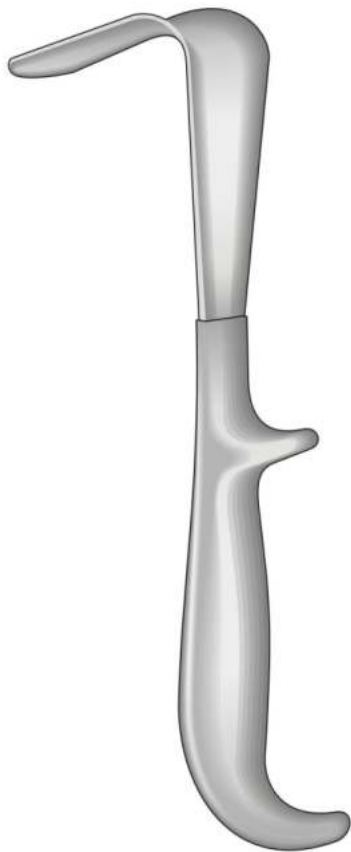
ST.MARKS
ST-4517
290 mm

ST.MARKS
ST-4518
330 mm

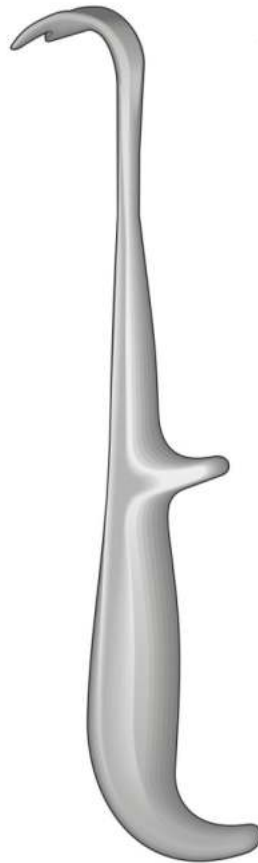
ST.MARKS
ST-4519
330 mm



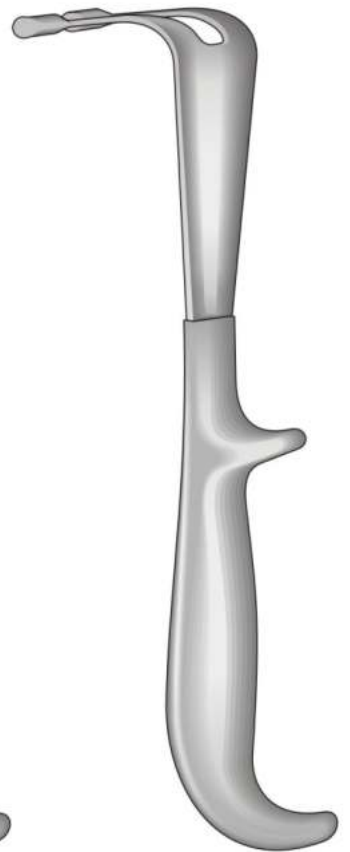
YOUNG
ST-4520
215 mm



YOUNG
ST-4521
210 mm

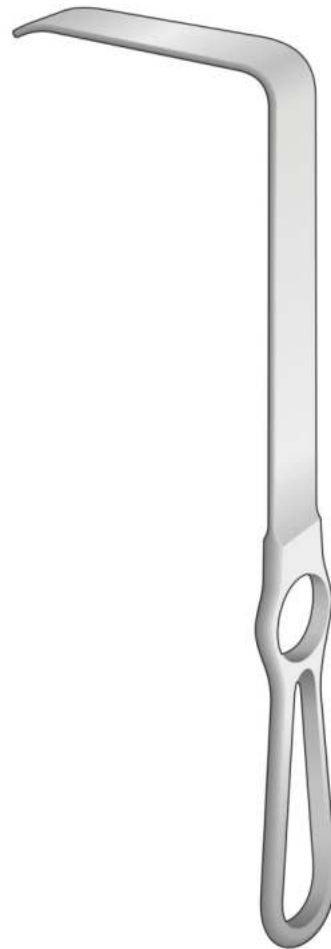
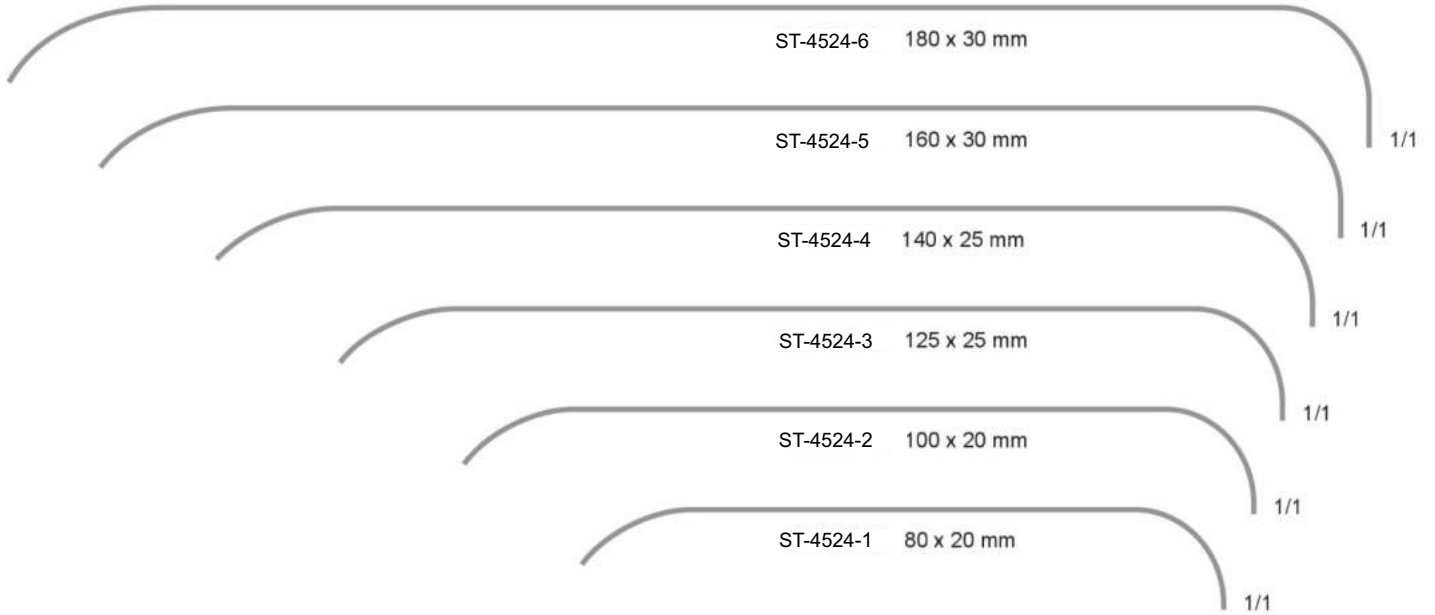


YOUNG
ST-4522
220 mm

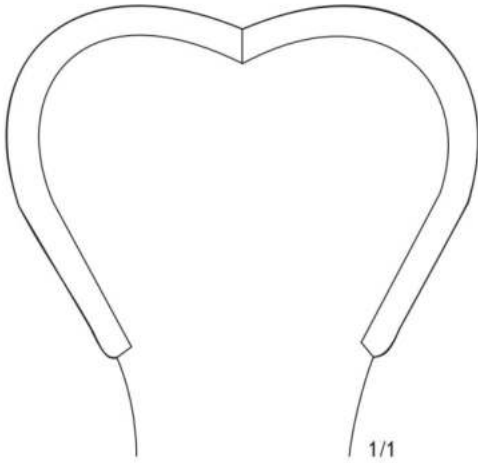


YOUNG
ST-4523
210 mm

new

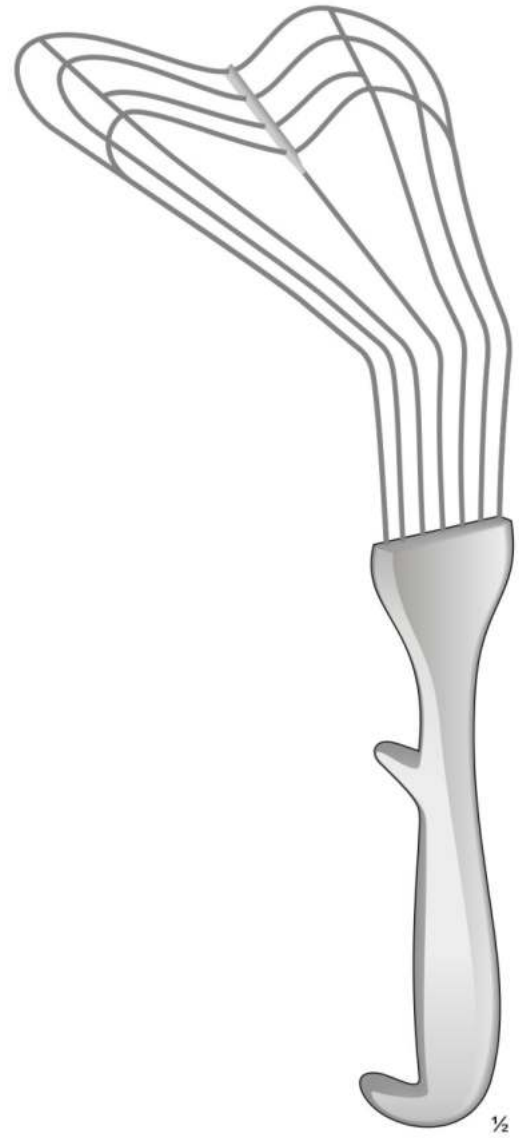


BRUNNER
ST-4524
250 mm



HARRINGTON-PEMBERTON
ST-4525 175 x 64 mm
295 mm

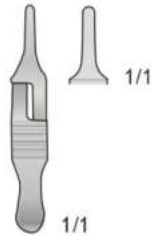
← 137 mm →



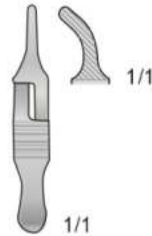
ST-4526
300 mm



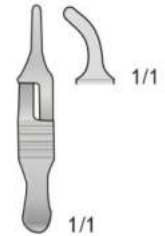
Gefäßclips - Vessel Clips
Clamps vascolari - Clamps vasculares
Clamps vasculaires



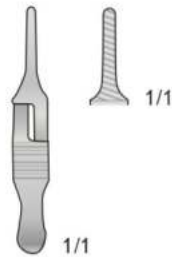
DIEFFENBACH
ST-4527
30 mm



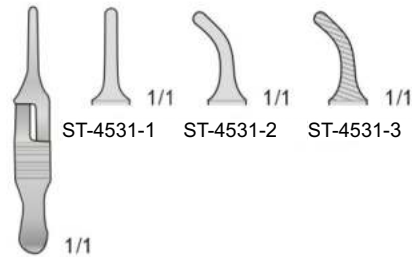
DIEFFENBACH
ST-4528
30 mm



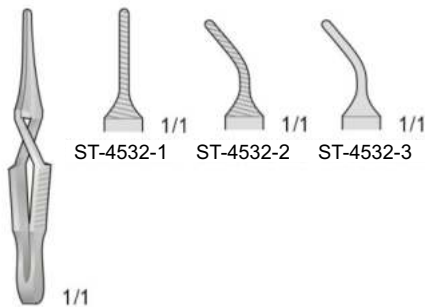
DIEFFENBACH
ST-4529
30 mm



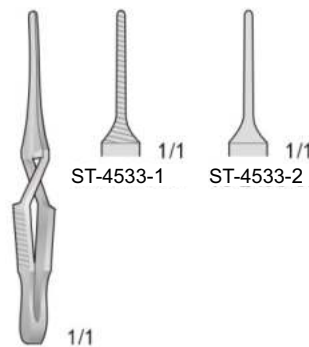
DIEFFENBACH
ST-4530
30 mm



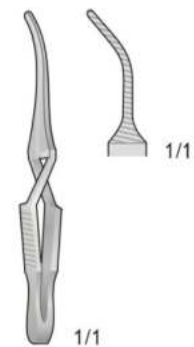
DIEFFENBACH
ST-4531
35 mm



ST-4532
40 mm

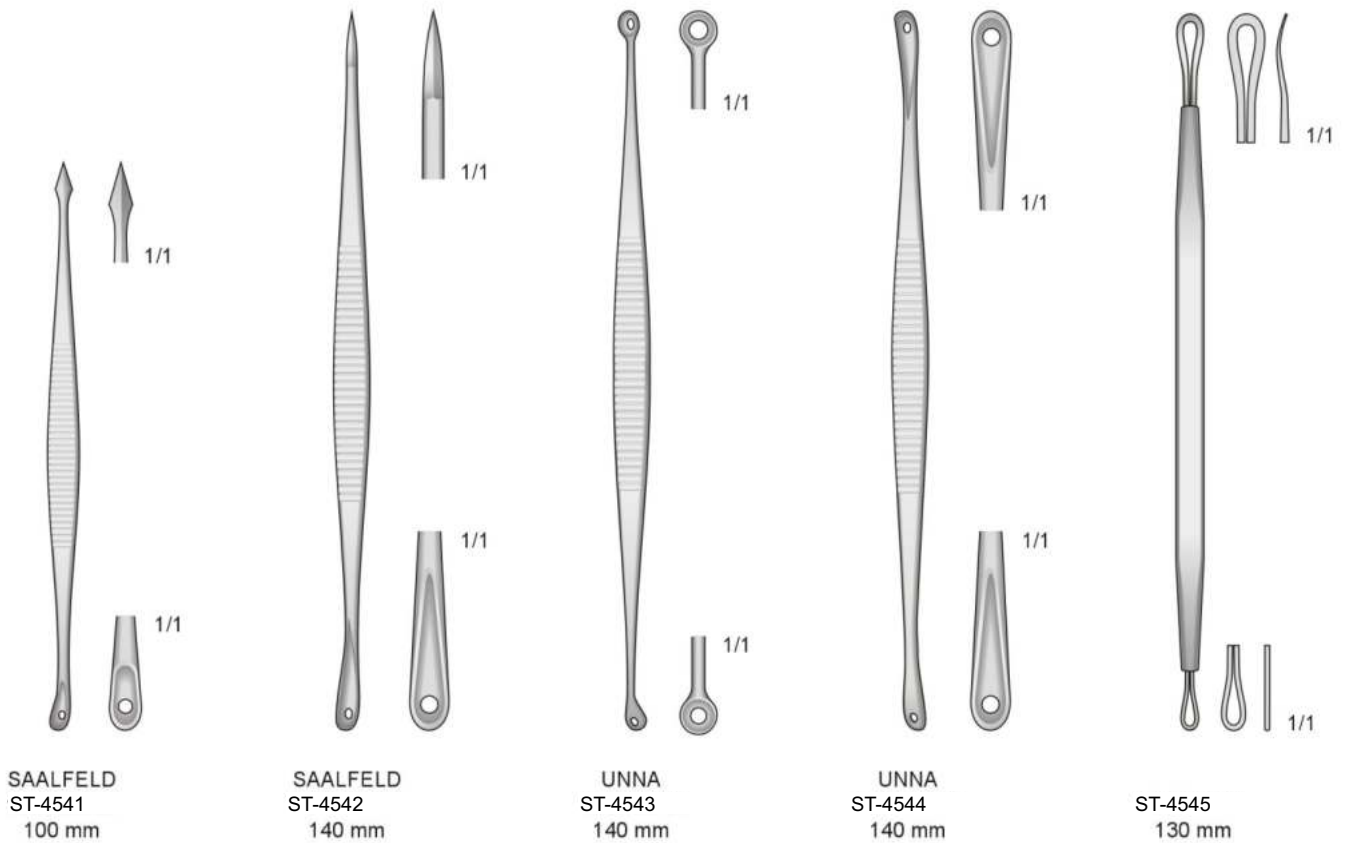
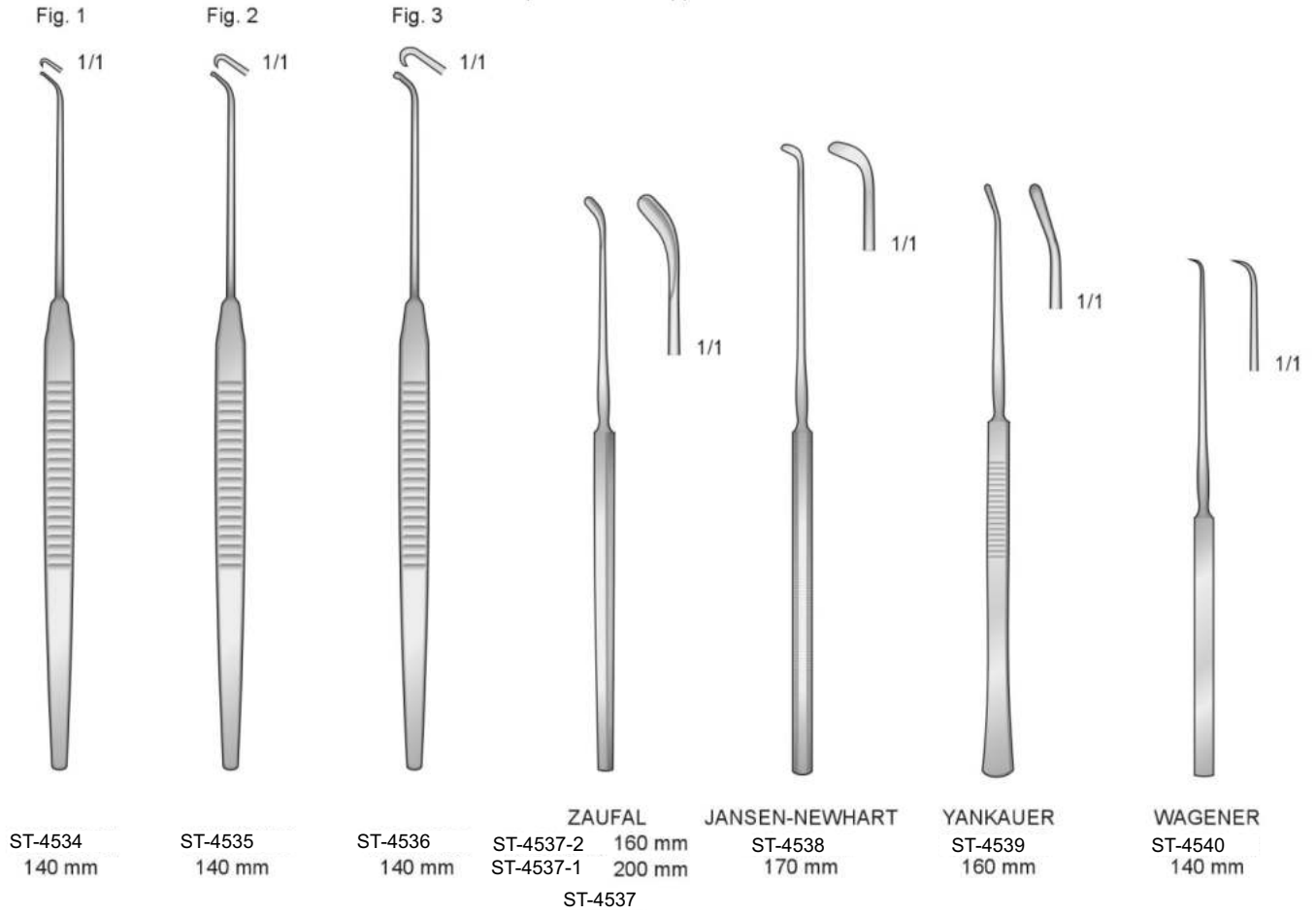


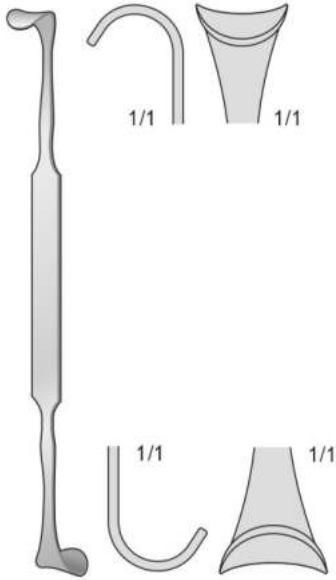
ST-4533
45 mm



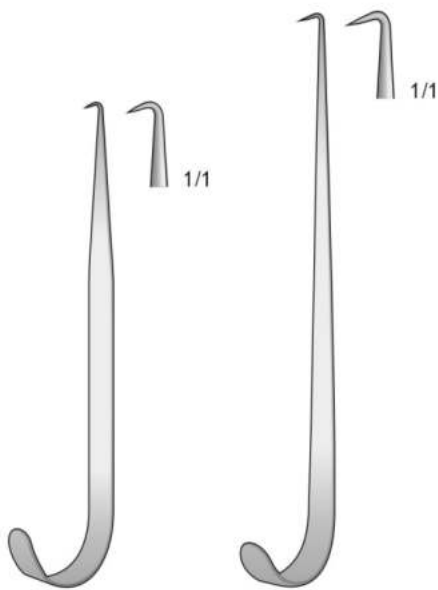
45 mm

Komplettsset mit 3 Haken Stripper - Set complete with 3 Vein Stripper
Set completo con 3 uncini per vene - Set completo con 3 sondas para verices
Set complete avec 3 stripper a anneau





ROSE
ST-4546
130 mm



JACKSON
ST-4547
130 mm

JACKSON
ST-4548
150 mm

Links
Left
Sinistra
Izquierda
Gauche



1/1

Rechts
Right
Dextra
Derecha
Droit



1/1

Scharf
Sharp
Acuto
Agudo
Pointu



BOSE
ST-4549
160 mm

BOSE
ST-4550
160 mm

Links
Left
Sinistra
Izquierda
Gauche



1/1

Rechts
Right
Dextra
Derecha
Droit



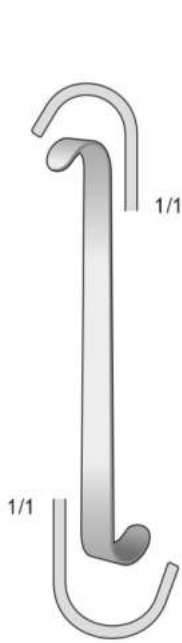
1/1

Stumpf
Blunt
Smusso
Romo
Mousse



BOSE
ST-4551
160 mm

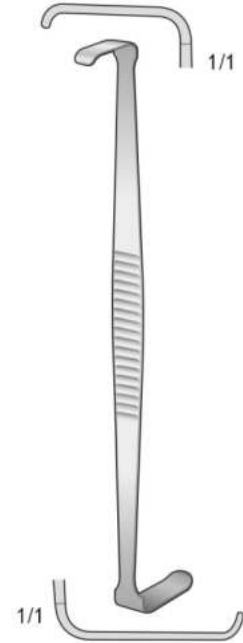
BOSE
ST-4552
160 mm



LUER
ST-4553
110 mm



NEWS
ST-4554
150 mm



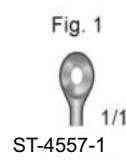
HOUSE
ST-4555
150 mm

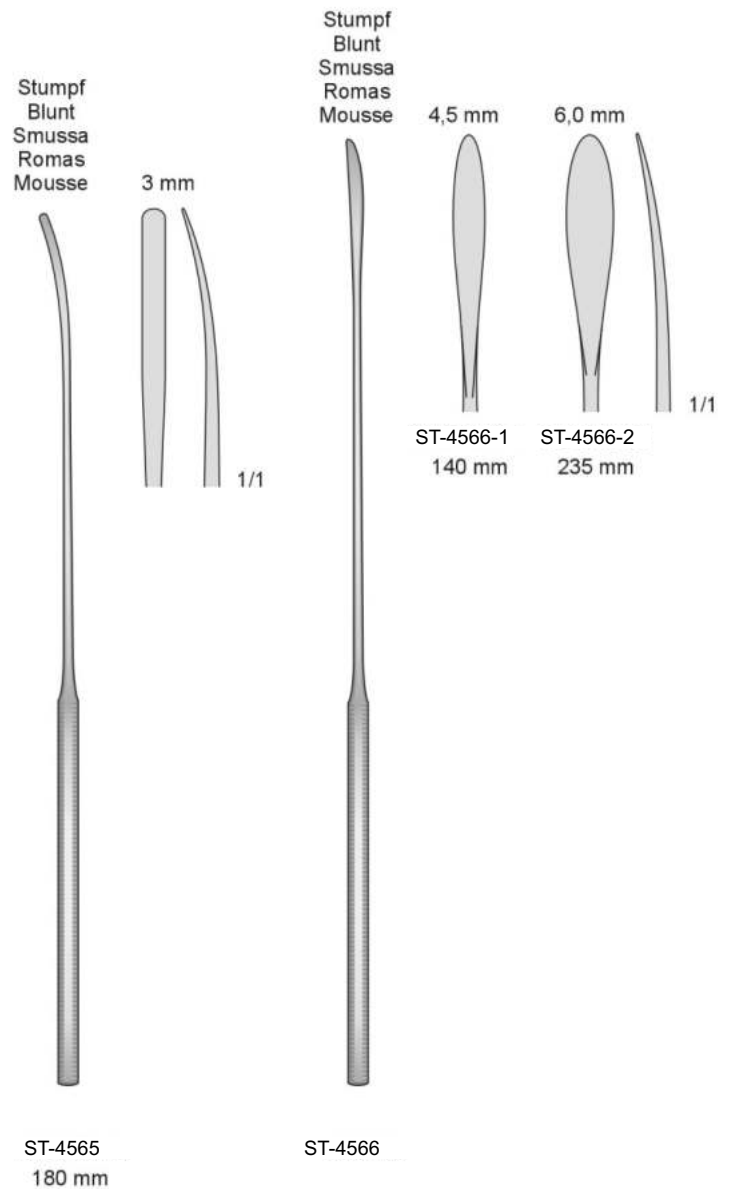
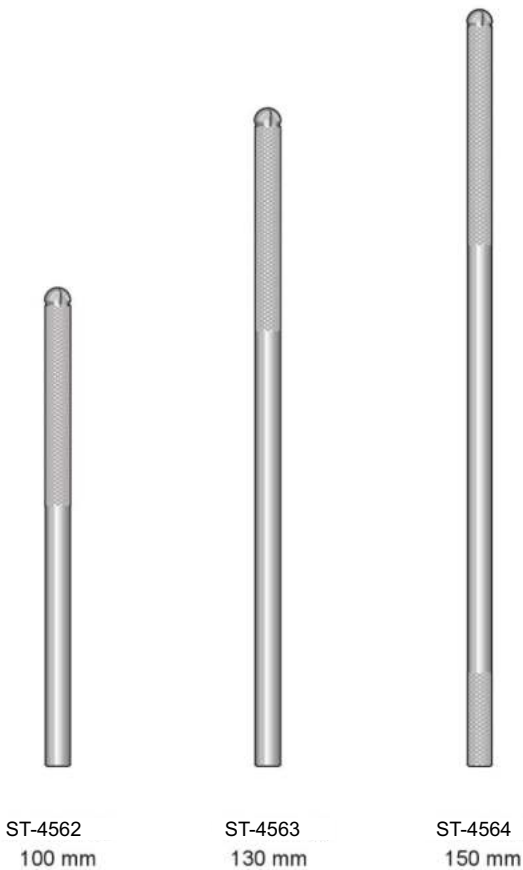
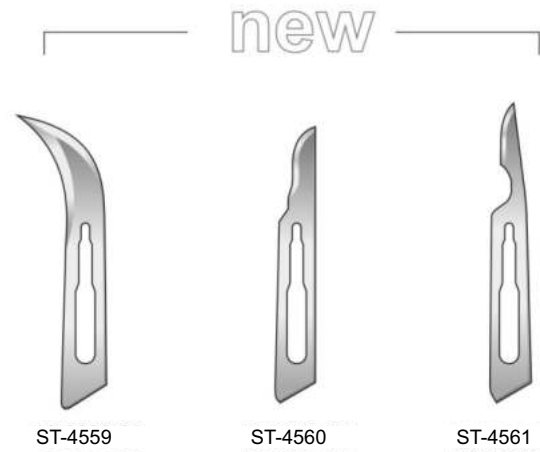
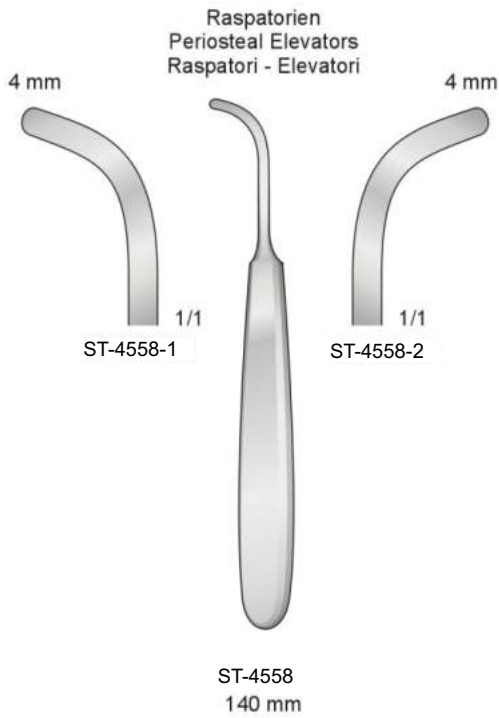


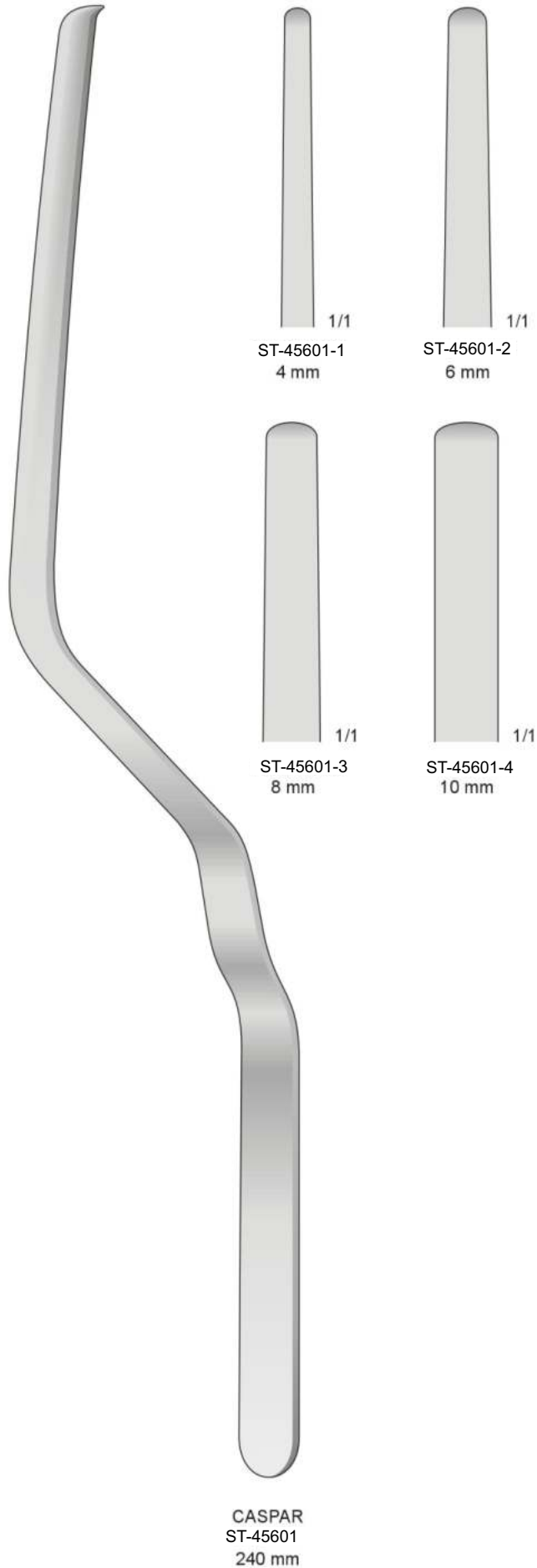
FOX
ST-4556
140 mm



WOLF
ST-4557
140 mm

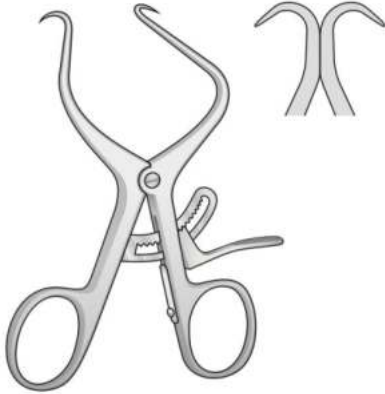






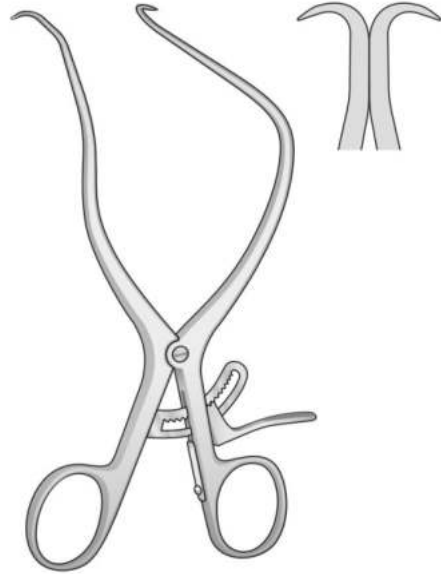


Femur-Wundspreizer für kinder
Femur Retractor for children
Divaricatore femorale per bambini



DE BAKEY
ST-45602
100 mm

Femur-Wundspreizer
Femur Retractor
Divaricatore femorale



DE BAKEY
ST-45603
170 mm

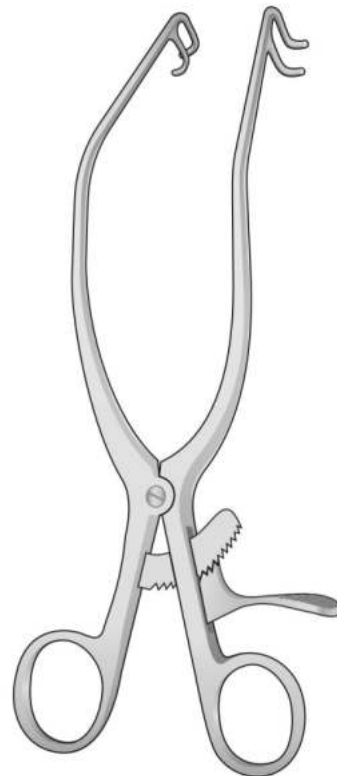
Wundspreizer
Retractors for shoulder
Divaricatori da spalla
Separadores
Ecarteurs

Stumpf - Blunt
Smusso - Romo
Mousse



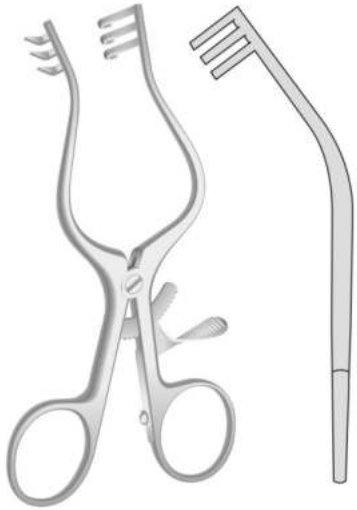
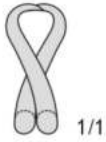
ST-45604
215 mm

Stumpf - Blunt
Smusso - Romo
Mousse



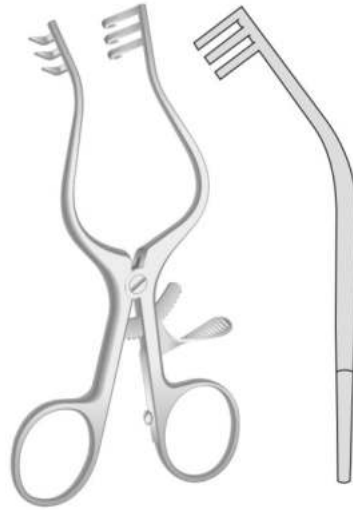
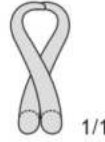
KÖLBEL
ST-45605
180 mm





Scharf
Sharp
Acuto
Agudo
Pointu

WULLSTEIN
ST-4569
130 mm

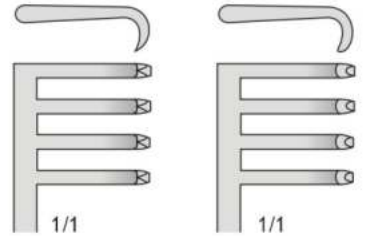


Stumpf
Blunt
Smusso
Romo
Mousse

WULLSTEIN
ST-4570
130 mm

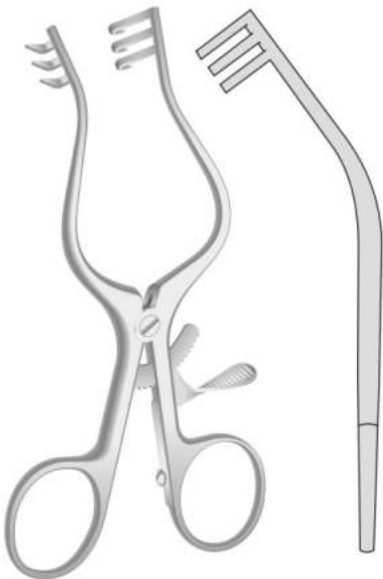
Scharf
Sharp
Acuto
Agudo
Pointu

Stumpf
Blunt
Smusso
Romo
Mousse



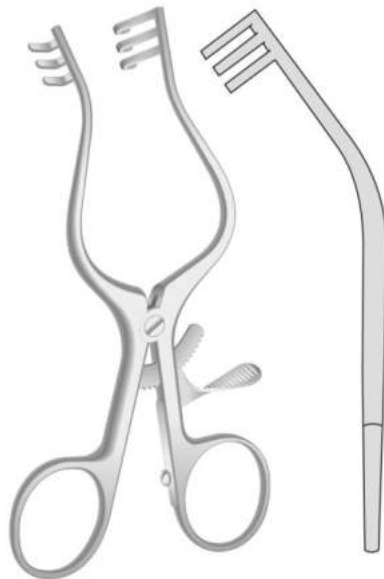
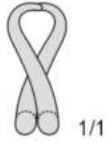
ST-4568-1

ST-4568-2



Scharf
Sharp
Acuto
Agudo
Pointu

WULLSTEIN
ST-4566
160 mm

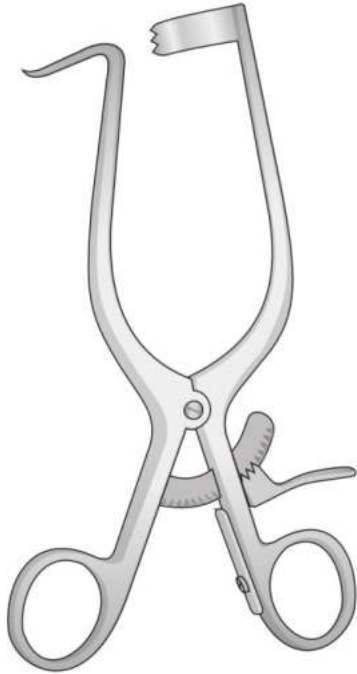


Stumpf
Blunt
Smusso
Romo
Mousse

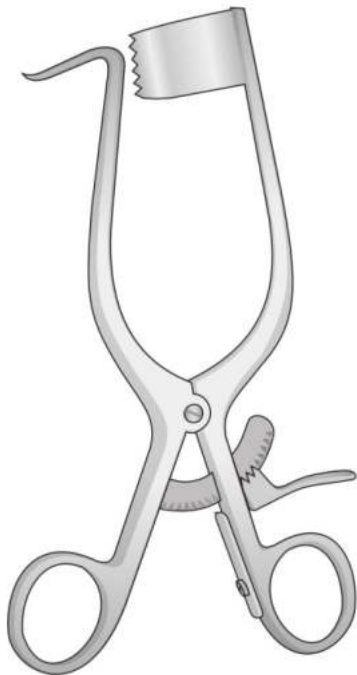
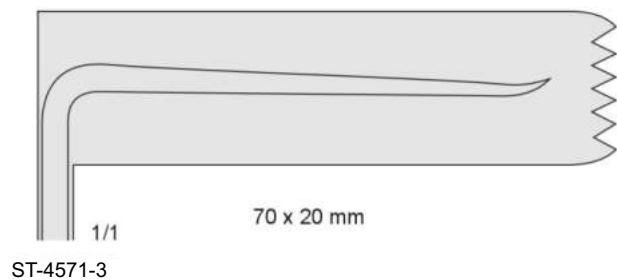
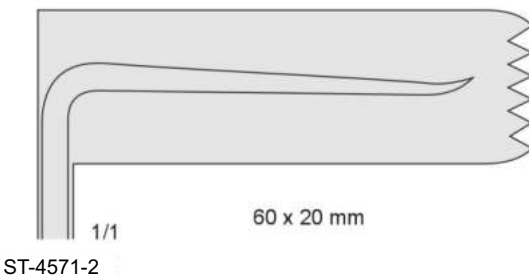
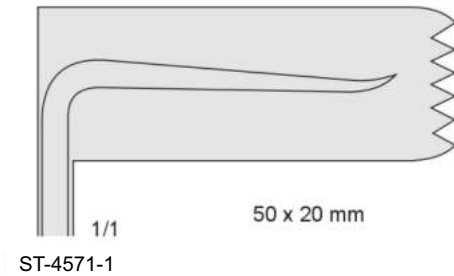
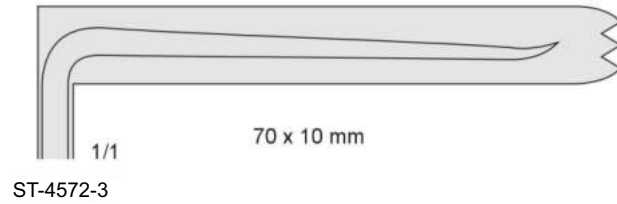
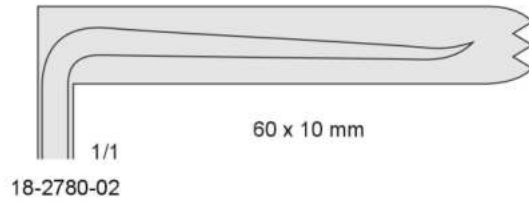
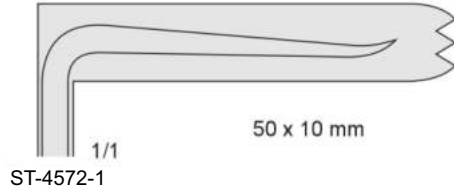
WULLSTEIN
ST-4567
160 mm



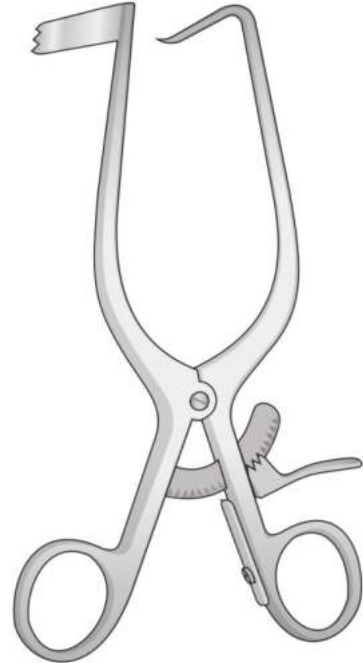
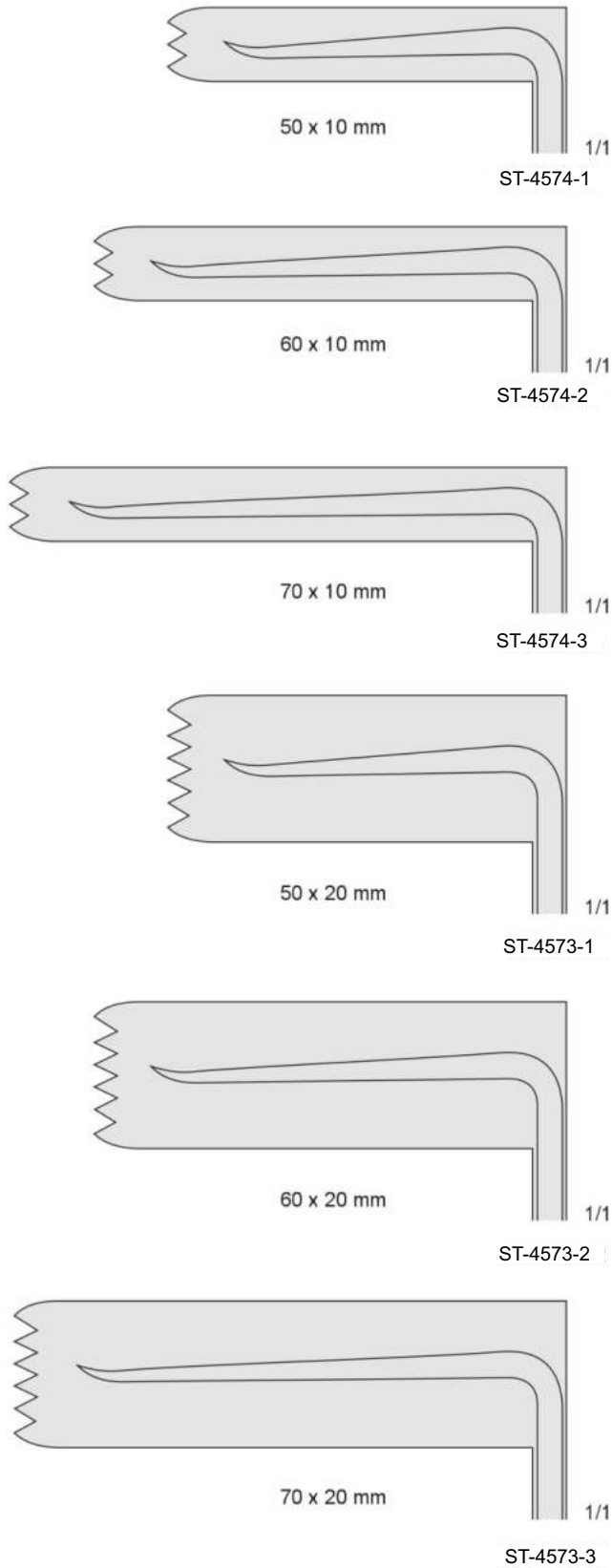
SCALP-CONTOUR
ST-4568
135 mm



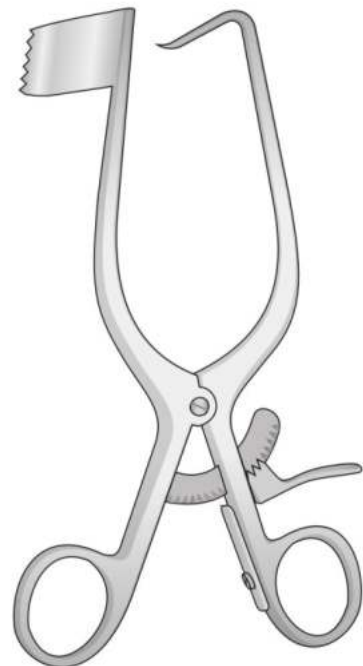
WILLIAMS
ST-4572
170 mm



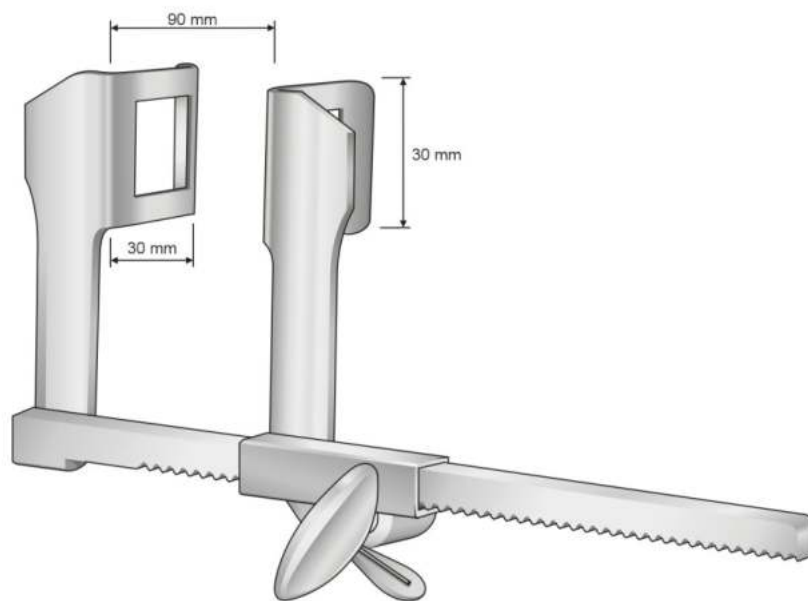
WILLIAMS
ST-4571
170 mm



WILLIAMS
ST-4574
170 mm

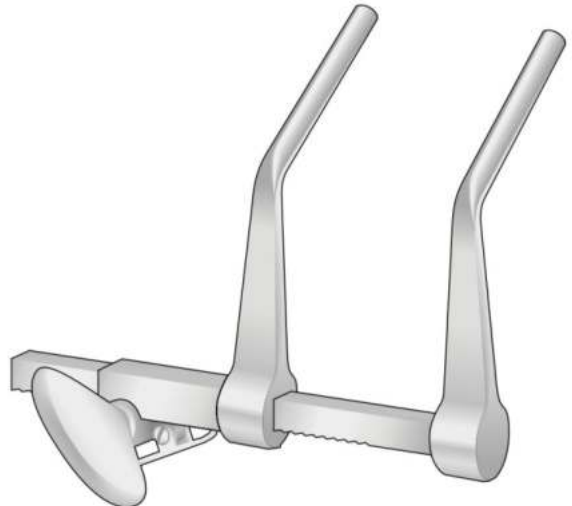


WILLIAMS
ST-4573
170 mm

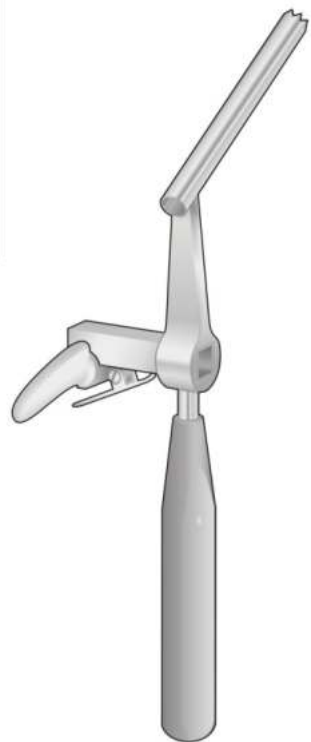


HAIGHT
ST-4575

CASPAR
ST-4578
Distraktor komplett rechts
Distractor complete right
Distrattore completo destro
ST-4578-1 Distraktor allein - 1 Distractor only
ST-4578-2 Bohrbüchse - 1 Drilling Guide
ST-4578-3 Spezialbohrer - 1 Special Drill
ST-4578-4 Distraktionsschrauben - 2 Distraction Screws
ST-4578-5 Schraubendreher - 1 Screw Driver

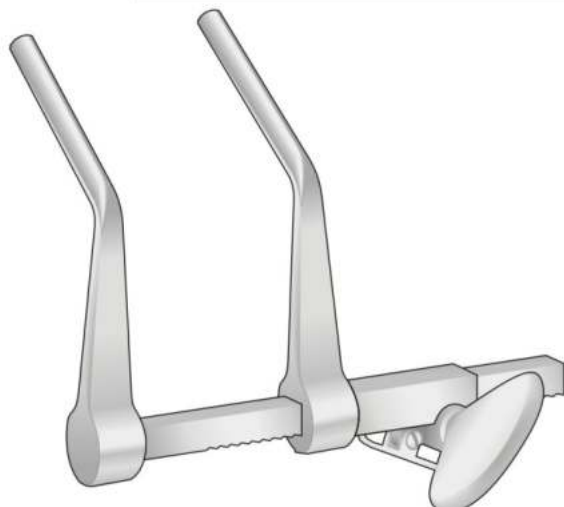


CASPAR
ST-4578
Distraktor rechts, Allein
Distractor right, Only
Distrattore destro, solo

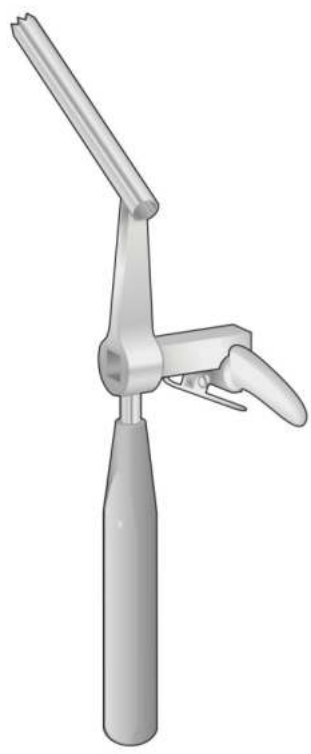


ST-4579
Bohrbüchse rechts, Allein
Drilling Guide right, Only
Guida punte destro, solo

CASPAR
ST-4576
Distraktor komplett links
Distractor complete left
Distrattore completo sinistro
ST-4576-1 Distraktor allein - 1 Distractor only
ST-4576-2 Bohrbüchse - 1 Drilling Guide
ST-4576-3 Spezialbohrer - 1 Special Drill
ST-4576-4 Distraktionsschrauben - 2 Distraction Screws
ST-4576-5 Schraubendreher - 1 Screw Driver



CASPAR
ST-4576
Distraktor links, Allein
Distractor left, Only
Distrattore sinistro, solo



ST-4577
Bohrbüchse links, Allein
Drilling Guide left, Only
Guida punte sinistro, solo

Screw Driver
Schraubendreher



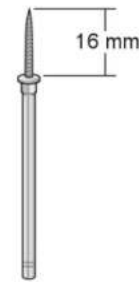
CASPAR
ST-4582
200 mm

Special Drill
Spezialbohrer
Ø 1,7 mm



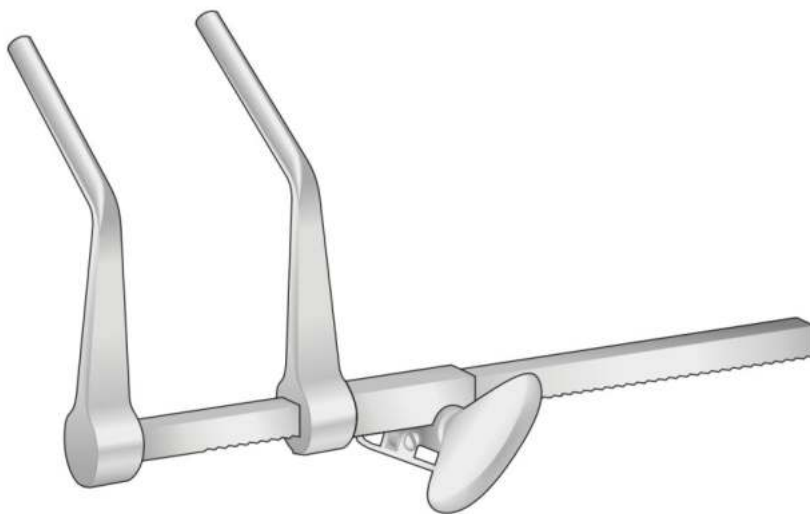
CASPAR
ST-4583
145 mm

Distraction Screw
Distractionsschrauben

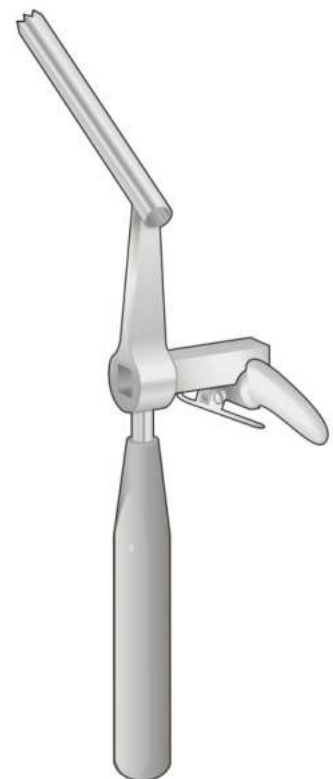


CASPAR
ST-4584
70 mm

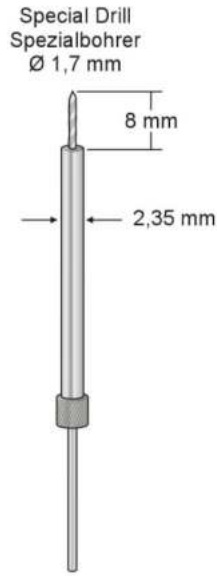
- CASPAR**
- Distraktor komplett links
Distractor complete left
Distrattore completo sinistro
- 1 Distraktor allein - 1 Distractor only
 - 1 Bohrbüchse - 1 Drilling Guide
 - 1 Spezialbohrer - 1 Special Drill
 - 2 Distractionsschrauben - 2 Distraction Screws
 - 1 Schraubendreher - 1 Screw Driver



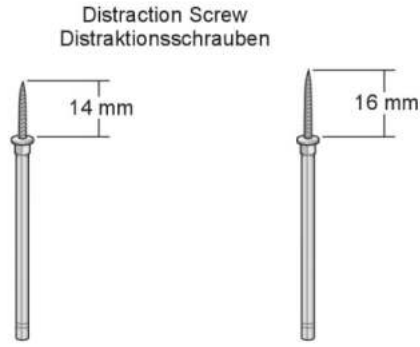
CASPAR
ST-4580
Distraktor links, Allein
Distractor left, Only
Distrattore sinistro, solo



ST-4581
Bohrbüchse links, Allein
Drilling Guide left, Only
Guida punte sinistro, solo



CASPAR
ST-4586
145 mm



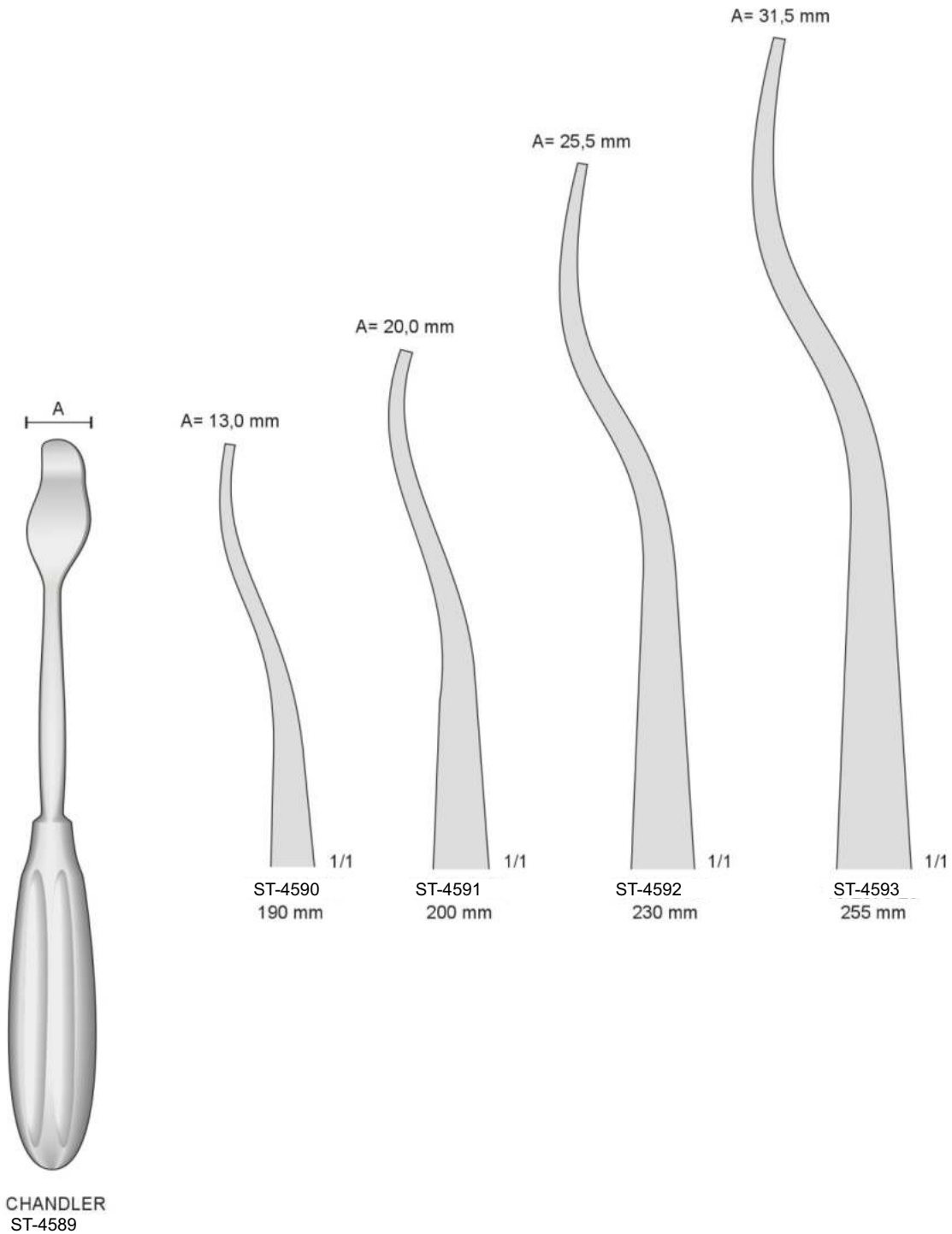
CASPAR
ST-4587
70 mm

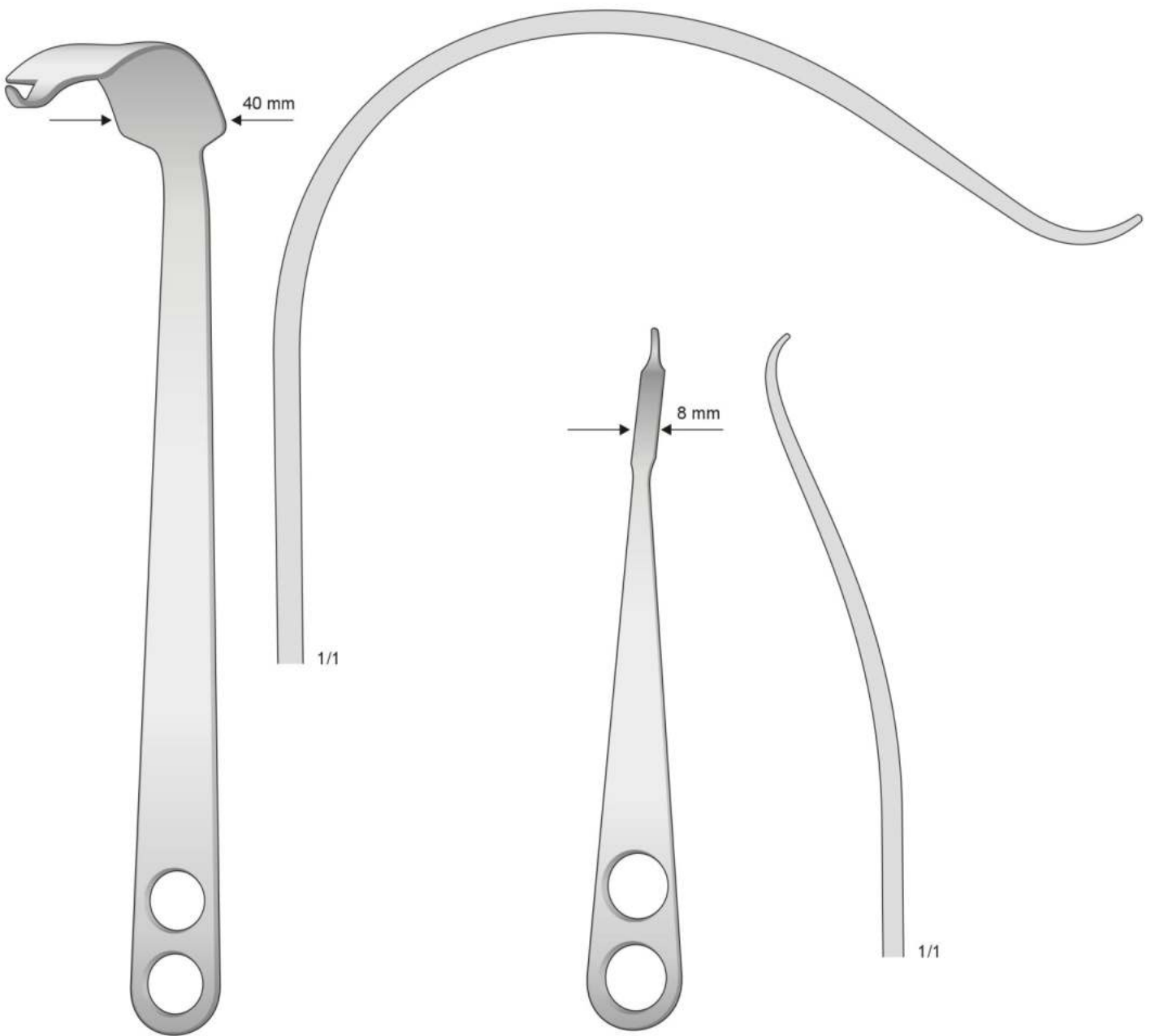
CASPAR
ST-4588
70 mm

Screw Driver
Schraubendreher



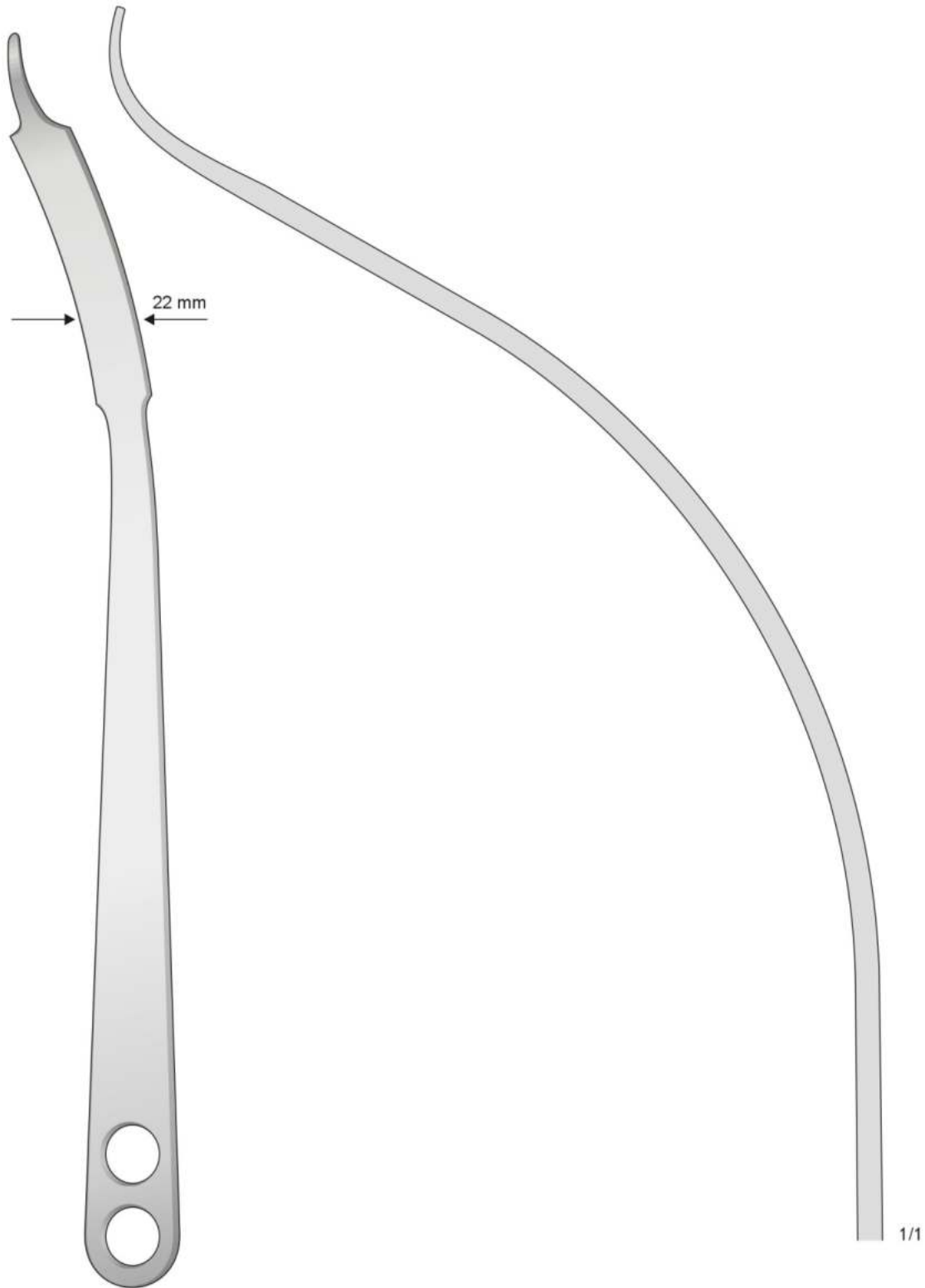
CASPAR
ST-4585
200 mm





HOHMANN
ST-4594
330 mm

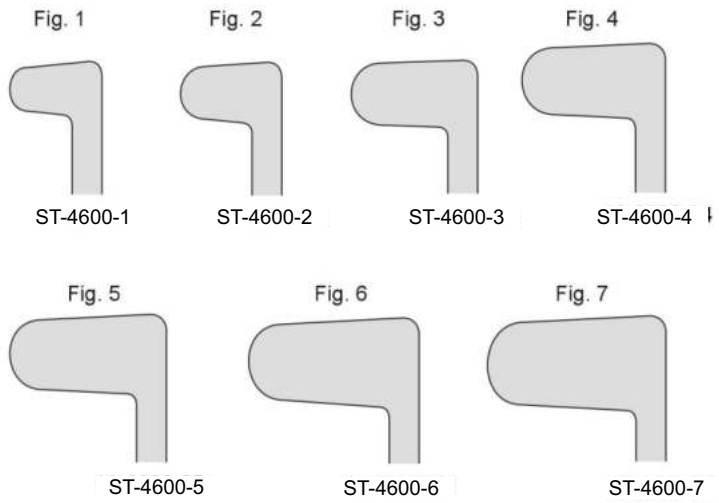
HOHMANN
ST-4595
225 mm



HOHMANN
ST-4596
400 mm

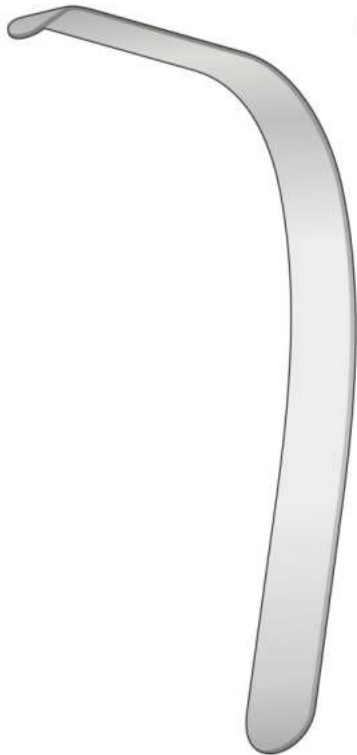


THUDICUM
ST-4600



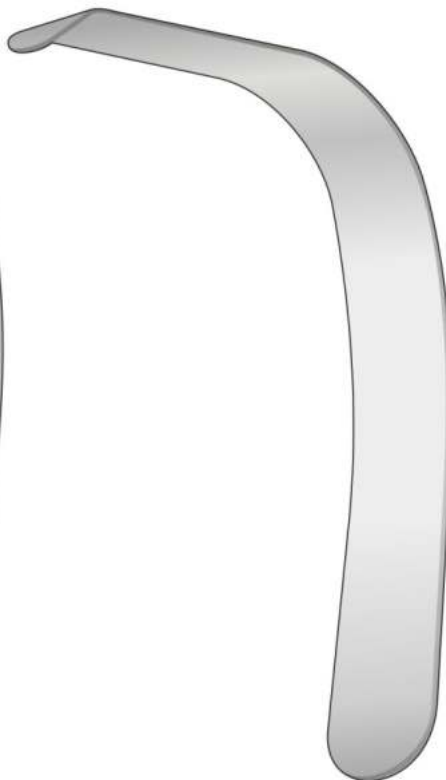
**Zungenspatel - Tongue Depressor
Adenotomie - Tonsillektomie**

10 x 13 mm



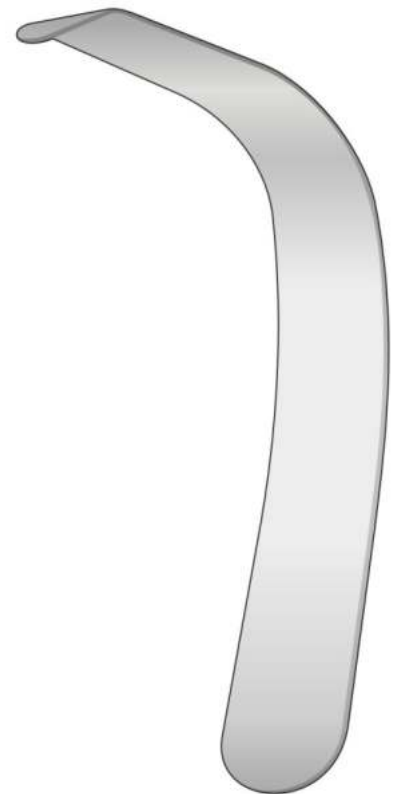
LACK
ST-4597

13 x 19 mm

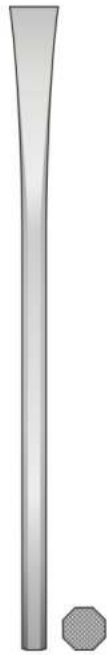


LACK
ST-4598

15 x 22 mm



LACK
ST-4599



SHEEHAN
ST-4604
160 mm



ST-4604-1
2 mm



ST-4604-2
4 mm



ST-4604-3
6 mm



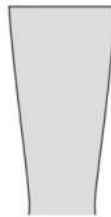
ST-4604-4
8 mm



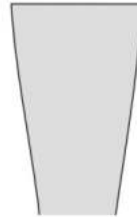
ST-4604-5
10 mm



ST-4604-5
12 mm



ST-4604-6
15 mm



ST-4604-7
18 mm

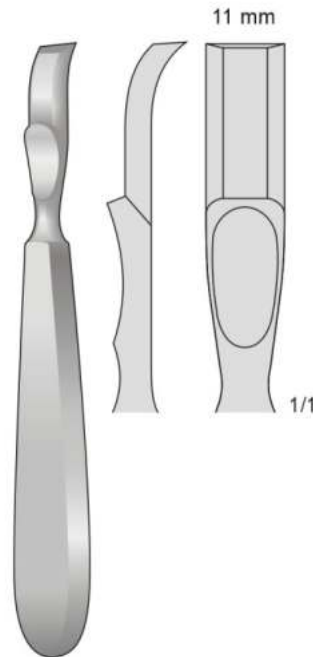


ST-4604-8
20 mm



HAJEK
ST-4601
220 mm

Ø 27 mm



FARABEU-FOLLIN
ST-4602
160 mm

11 mm

1/1



EPKER
ST-4603
180 mm



ST-4603-1
6 mm

1/1



ST-4603-2
8 mm

1/1



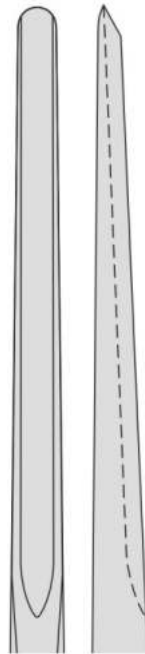
8 mm



COSCIA
ST-4605
180 mm

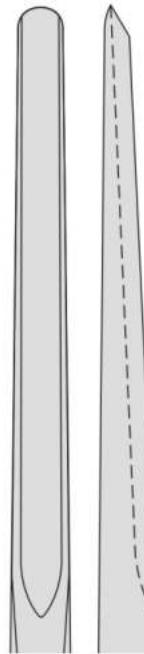


ALEXANDER
ST-4606
170 mm



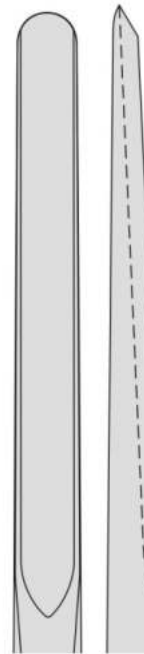
ST-4606-1
5 mm

1/1



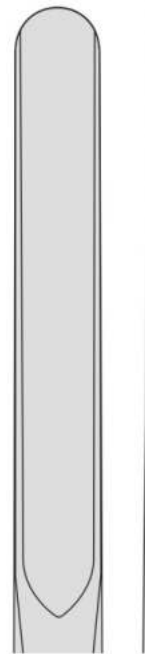
ST-4606-2
7 mm

1/1



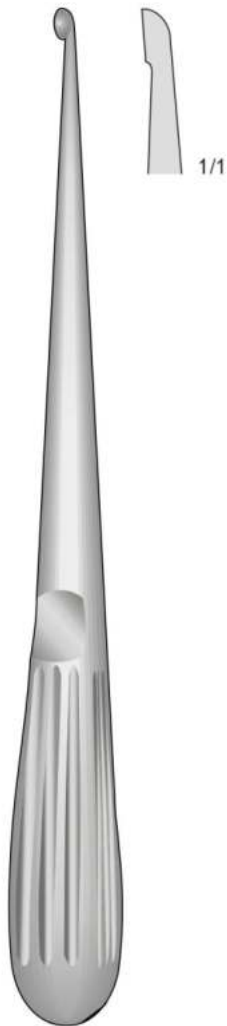
ST-4606-3
9 mm

1/1














ST-4606-4
11 mm

1/1



BRUNS
ST-4607
170 mm

<p>Fig.5/0 2,2 mm</p>  1/1 ST-4607-1	<p>Fig.4/0 2,5 mm</p>  1/1 ST-4607-2	<p>Fig.3/0 2,8 mm</p>  1/1 ST-4607-3	<p>Fig.2/0 3,3 mm</p>  1/1 ST-4607-4
<p>Fig.0 3,6 mm</p>  1/1 ST-4607-5	<p>Fig.1 4,3 mm</p>  1/1 ST-4607-6	<p>Fig.2 4,8 mm</p>  1/1 ST-4607-7	<p>Fig.3 5,6 mm</p>  1/1 ST-4607-8
<p>Fig.4 6,0 mm</p>  1/1 ST-4607-9	<p>Fig.5 6,7 mm</p>  1/1 ST-4607-10	<p>Fig.6 8,8 mm</p>  1/1 ST-4607-11	



BRUNS
ST-4608
225 mm

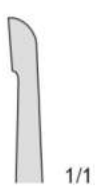











Fig.3/0 2,8 mm  1/1 ST-4608-1	Fig.2/0 3,3 mm  1/1 ST-4608-2	Fig.0 3,6 mm  1/1 ST-4608-3
Fig.1 4,3 mm  1/1 ST-4608-4	Fig.2 4,8 mm  1/1 ST-4608-5	Fig.3 5,6 mm  1/1 ST-4608-6
Fig.4 6,0 mm  1/1 ST-4608-7	Fig.5 6,7 mm  1/1 ST-4608-8	Fig.6 8,8 mm  1/1 ST-4608-9



BRUNS
ST-4609
225 mm

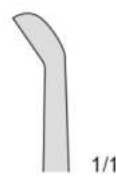









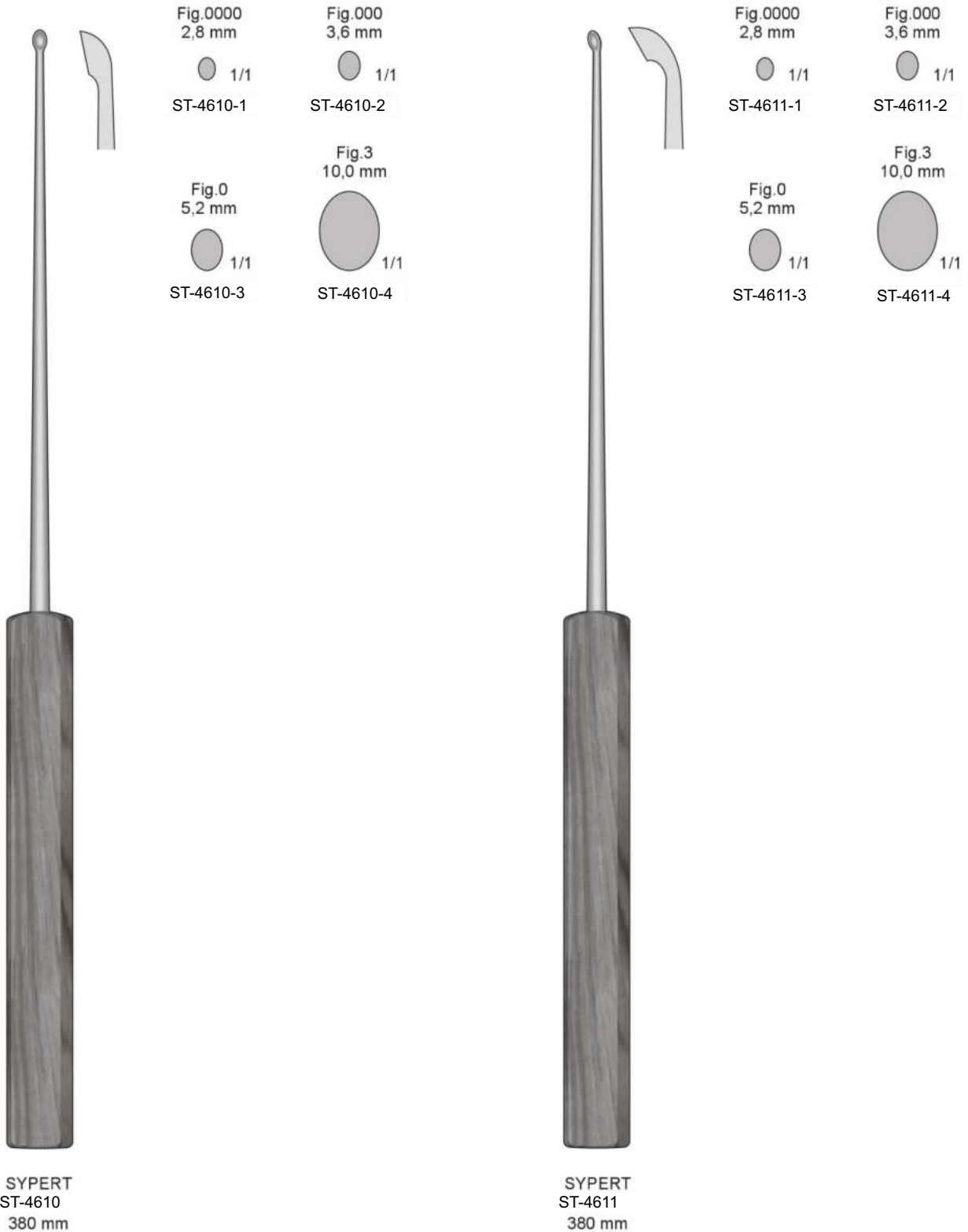
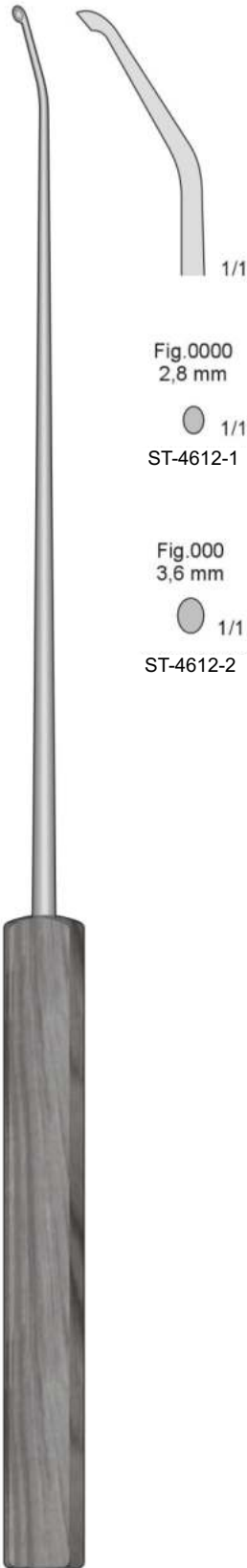


Fig.3/0 2,8 mm  1/1 ST-4609-1	Fig.2/0 3,3 mm  1/1 ST-4609-2	Fig.0 3,6 mm  1/1 ST-4609-3
Fig.1 4,3 mm  1/1 ST-4609-4	Fig.2 4,8 mm  1/1 ST-4609-5	Fig.3 5,6 mm  1/1 ST-4609-6
Fig.4 6,0 mm  1/1 ST-4609-7	Fig.5 6,7 mm  1/1 ST-4609-8	Fig.6 8,8 mm  1/1 ST-4609-9

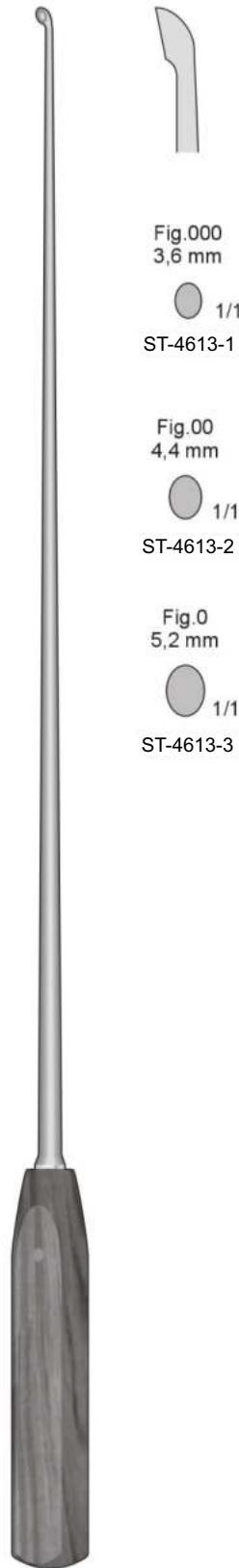
Mit Ferrozellgriff - With Ferrozell handle
Con manico Ferrozell - Con mango de Ferrozell
Avec poignée en Ferrozell



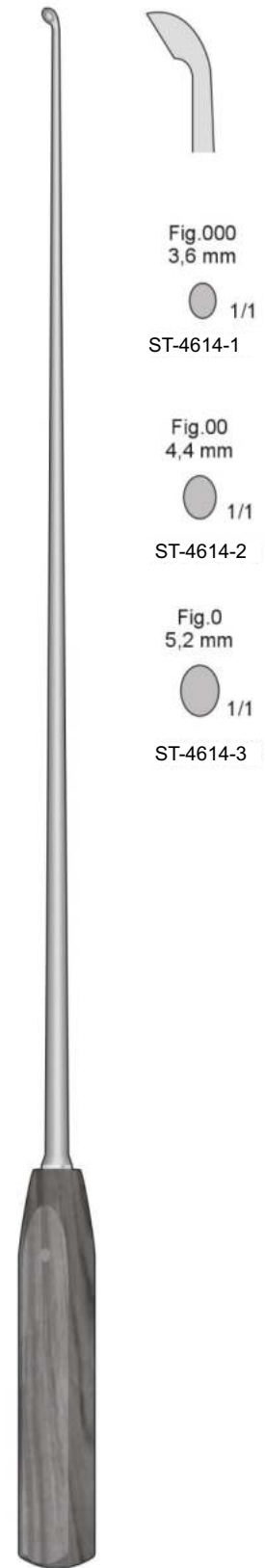
Mit Ferrozellgriff - With Ferrozell handle
Con manico Ferrozell - Con mango de Ferrozell
Avec poignée en Ferrozell



SYPERT
ST-4612
420 mm



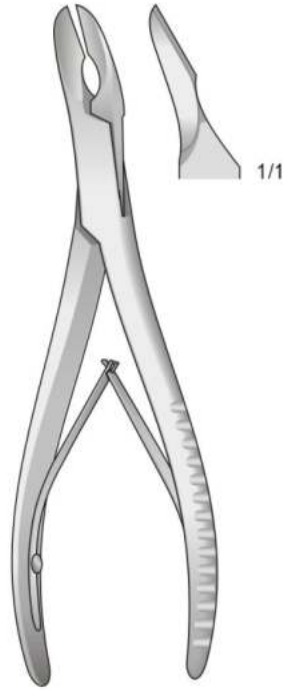
ST-4613
410 mm



ST-4614
410 mm



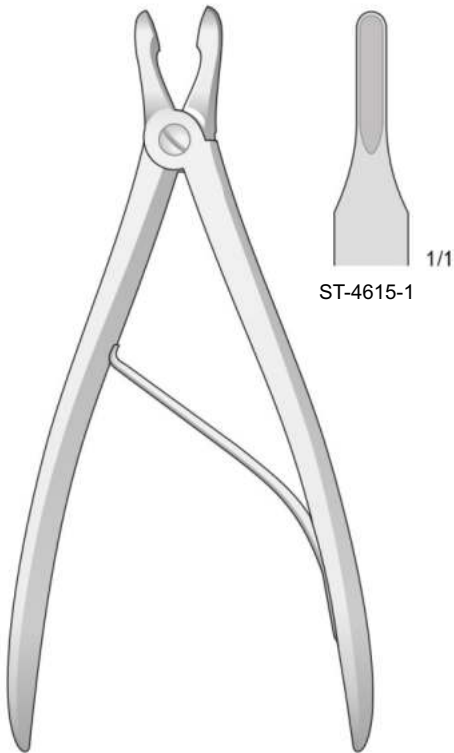
CLEVELAND
ST-4617 -14140 mm
ST-4617 -17170 mm



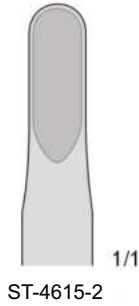
CLEVELAND
ST-4618 15 150 mm
ST-4618 17 170 mm



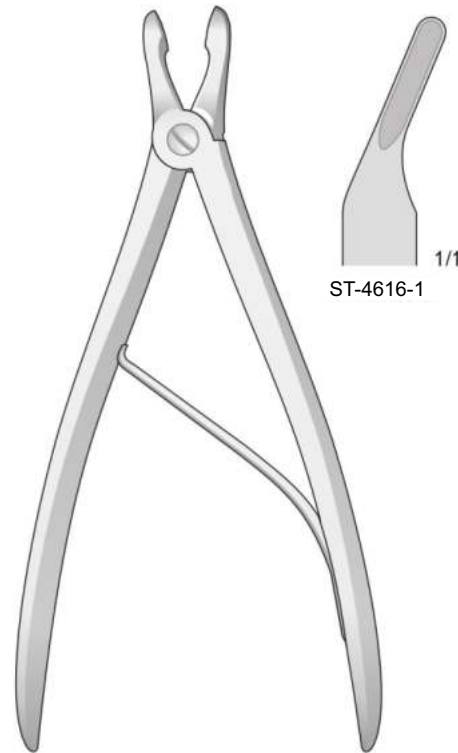
ST-4619
200 mm



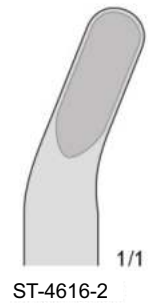
CUSHING
ST-4615
190 mm



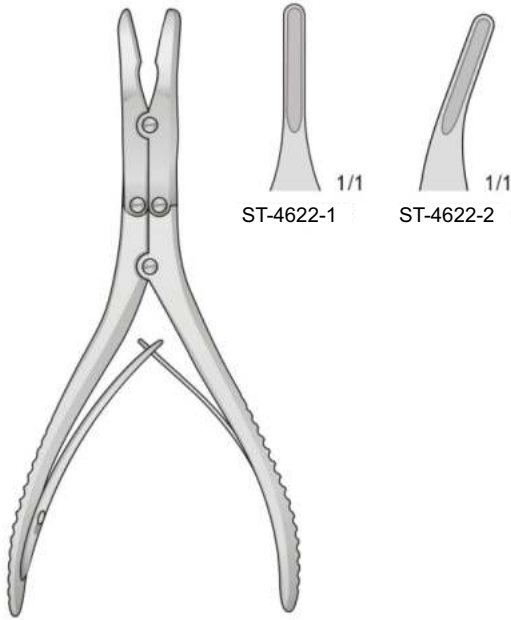
ST-4615-2



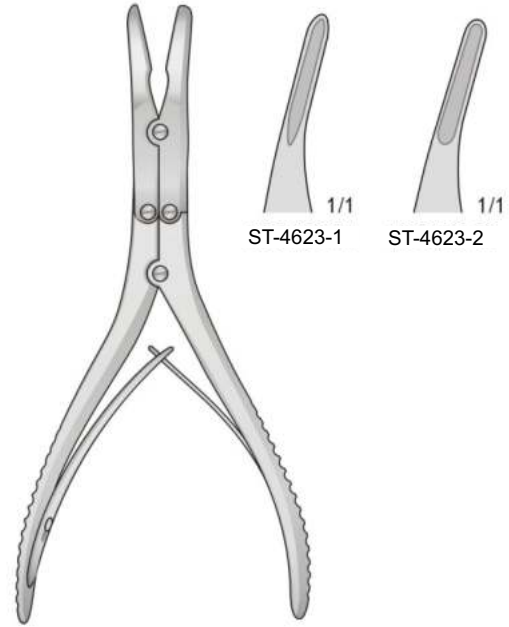
CUSHING
ST-4616
190 mm



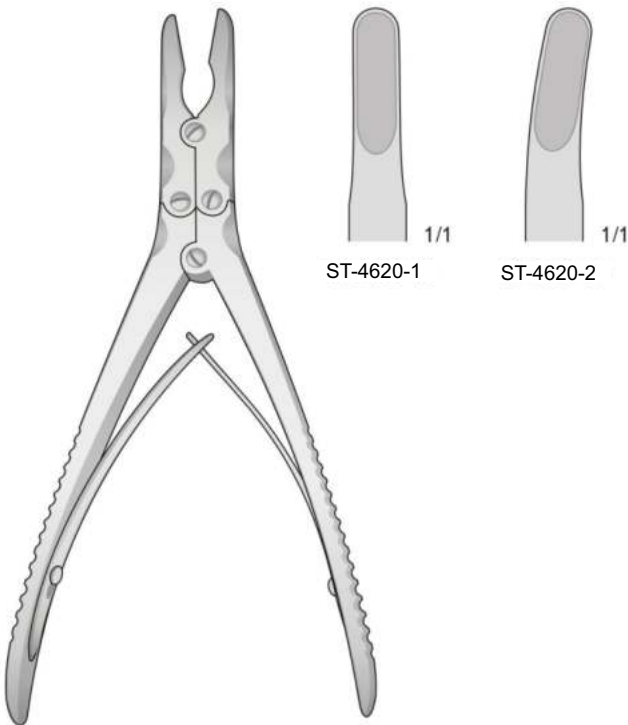
ST-4616-2



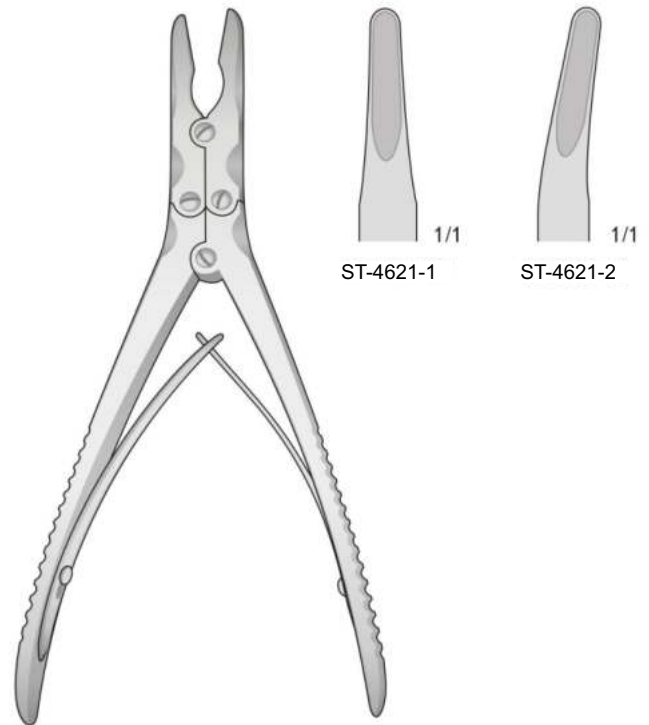
RUSKIN
ST-4622
150 mm



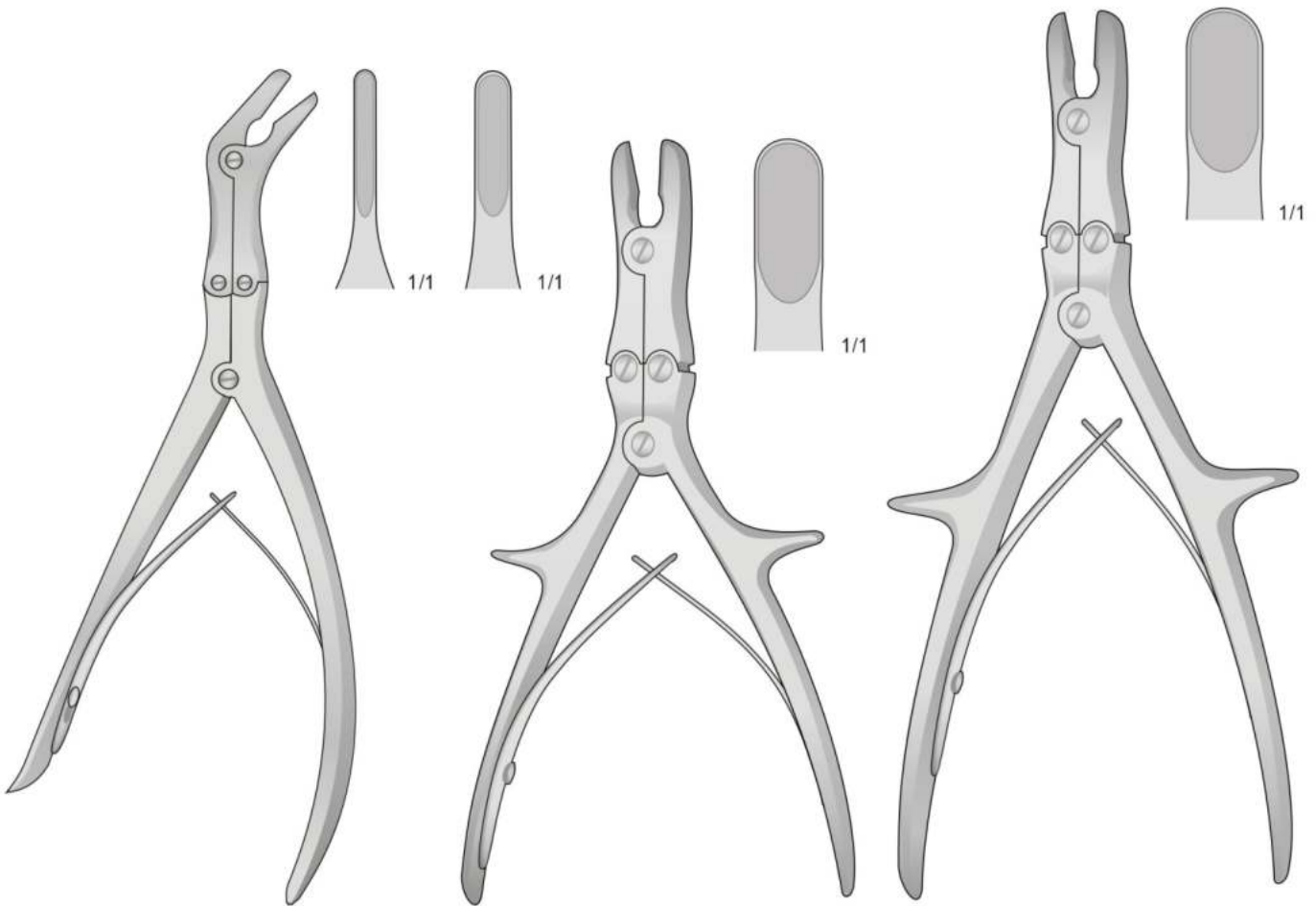
KLEINERT-KUTZ
ST-4623
155 mm



RUSKIN
ST-4620
185 mm



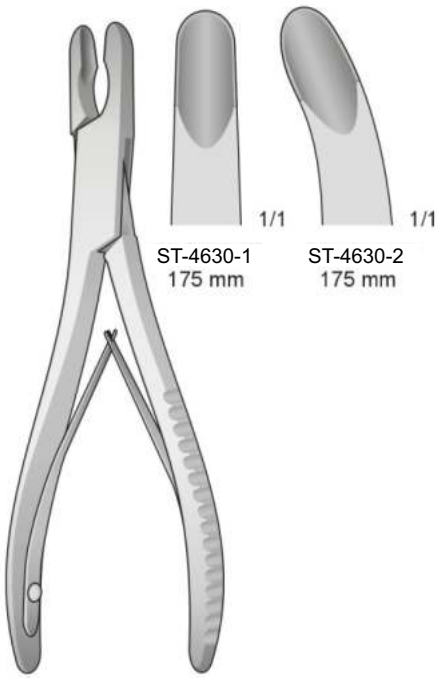
RUSKIN
ST-4621
185 mm



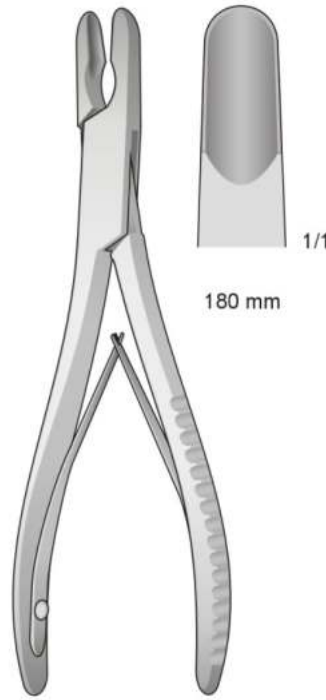
LEKSELL
ST-4624
250 mm

LUER-STILLE
ST-4625
220 mm

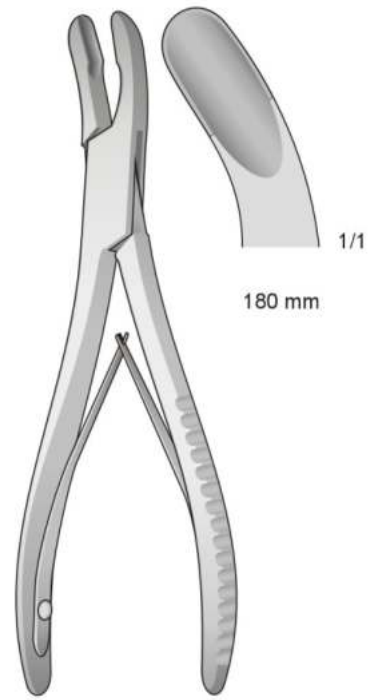
LUER-STILLE
ST-4626
260 mm



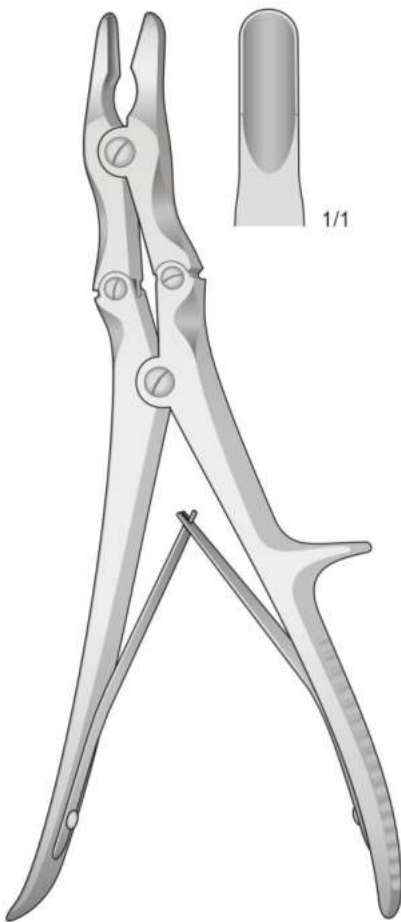
LUER
ST-4630
175 mm



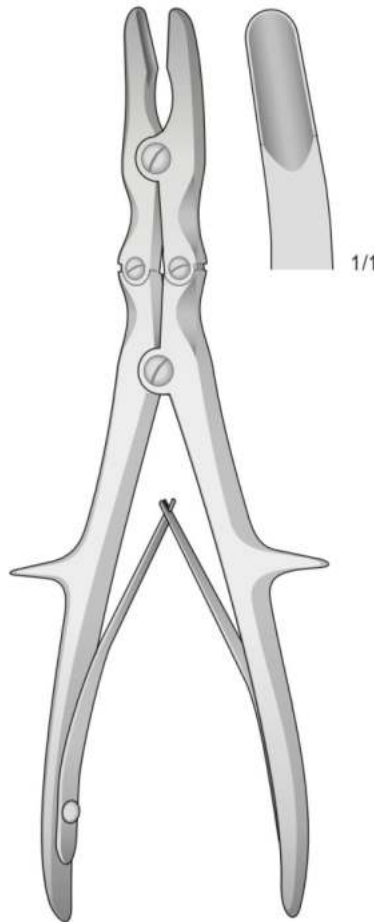
LUER
ST-4631
180 mm



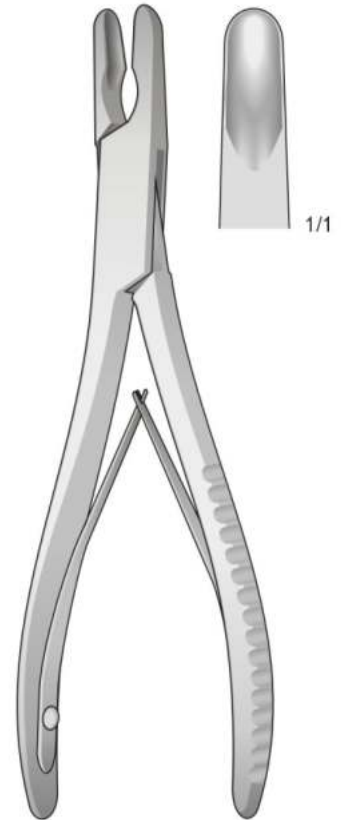
LUER
ST-4632
180 mm



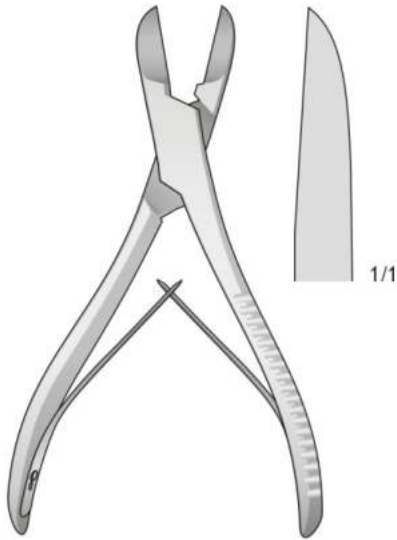
LEKSELL-STILLE
ST-4627
240 mm



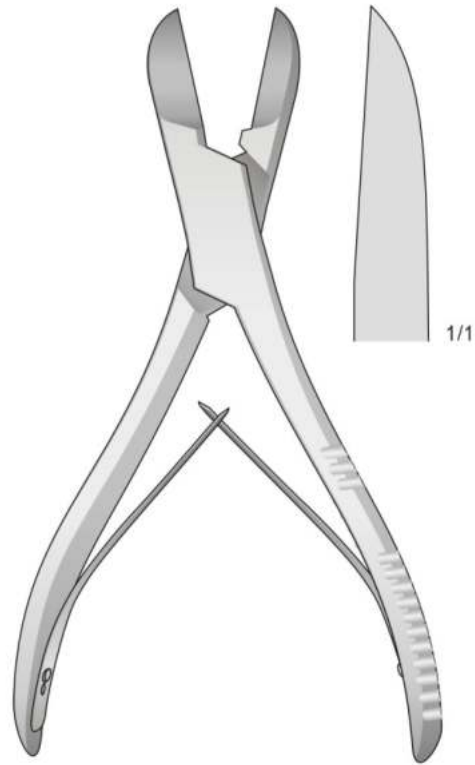
STILLE-RUSKIN
ST-4628
240 mm



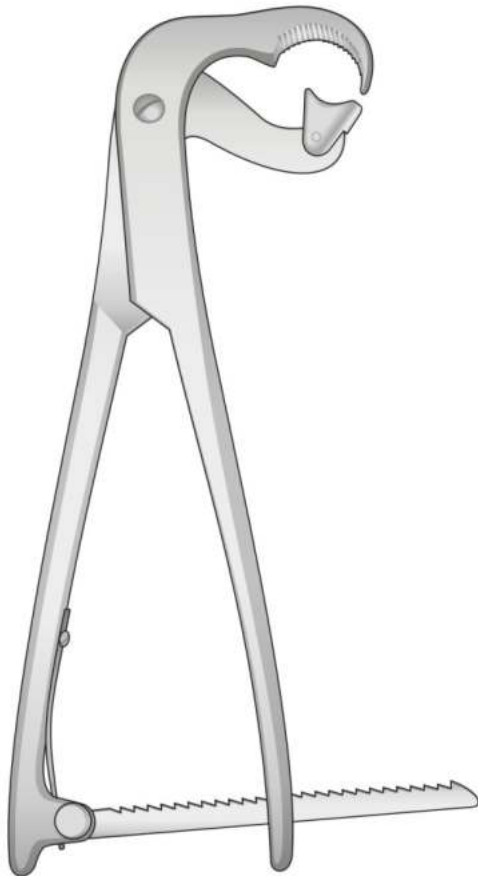
ADSON
ST-4629
210 mm



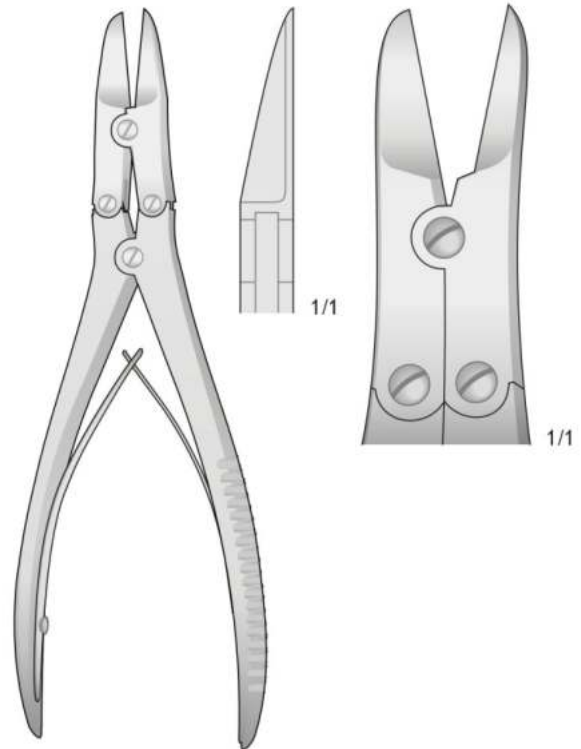
LISTON
ST-4635
140 mm



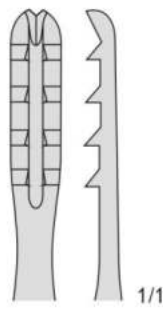
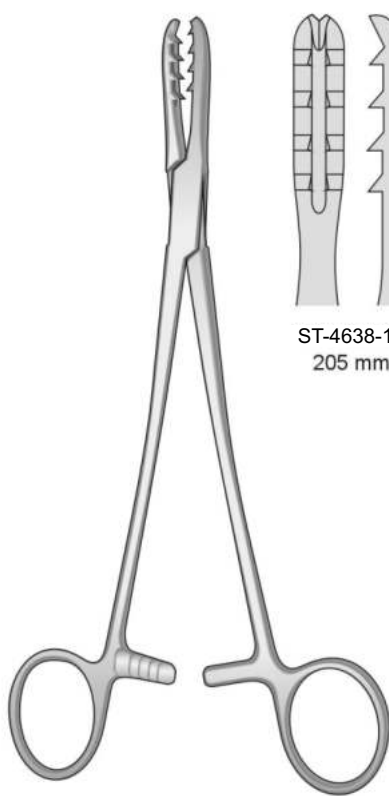
LISTON
ST-4636
200 mm



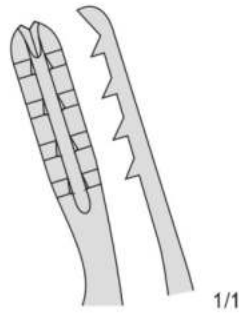
ST-4633
275 mm



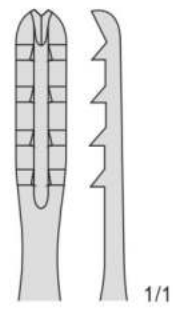
RUSKIN-LISTON
ST-4634
190 mm



ST-4638-1
205 mm



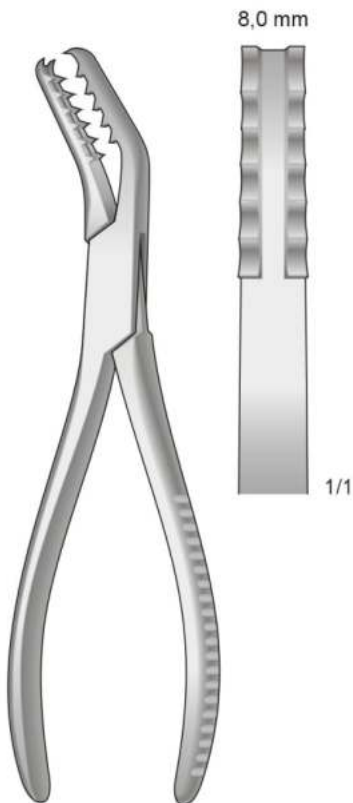
ST-4638-2
205 mm



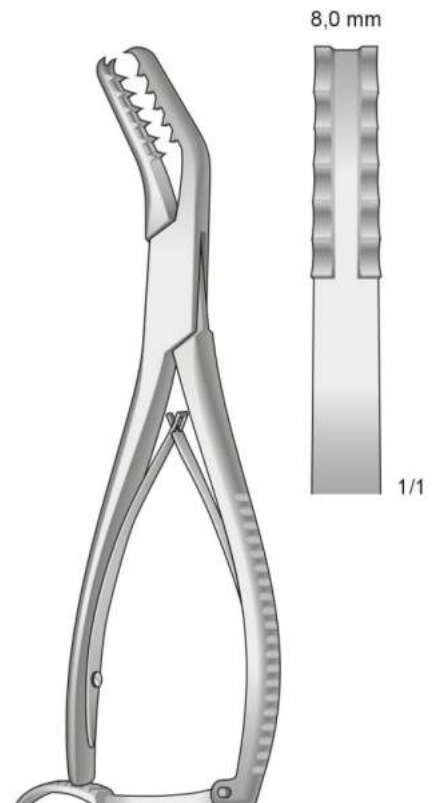
ST-4639-1
205 mm

BIRCHER-GANSKE
ST-4638
205 mm

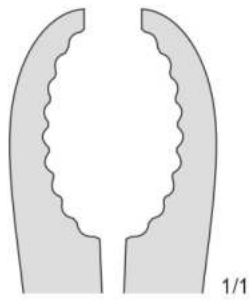
BIRCHER-GANSKE
ST-4639
200 mm



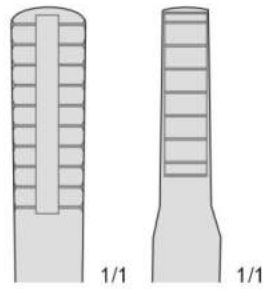
SEMB
ST-4636
190 mm



SEMB
ST-4637
190 mm

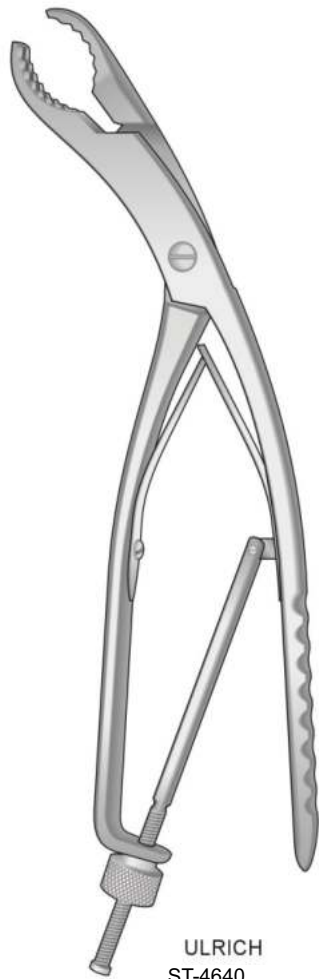


1/1

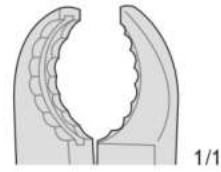


1/1

1/1

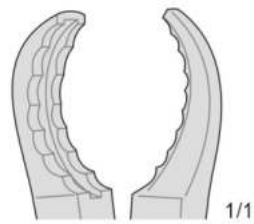


ULRICH
ST-640



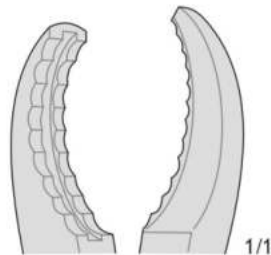
1/1

ST-640-1
220 mm



1/1

ST-640-2
240 mm



1/1

ST-640-3
270 mm



Ersatz für
Replacement for
Ricambio per
Repuesto para
ST-4643

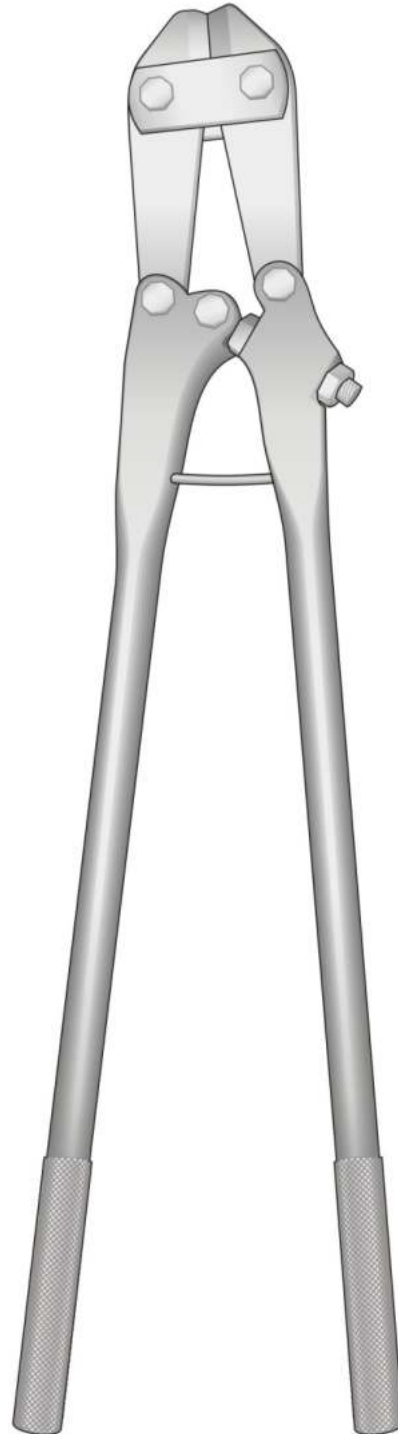


Von Kirschner-Drähten Ø 6 mm
For Kirschner wires Ø 6 mm
Per chiodi Kirschner Ø 6 mm

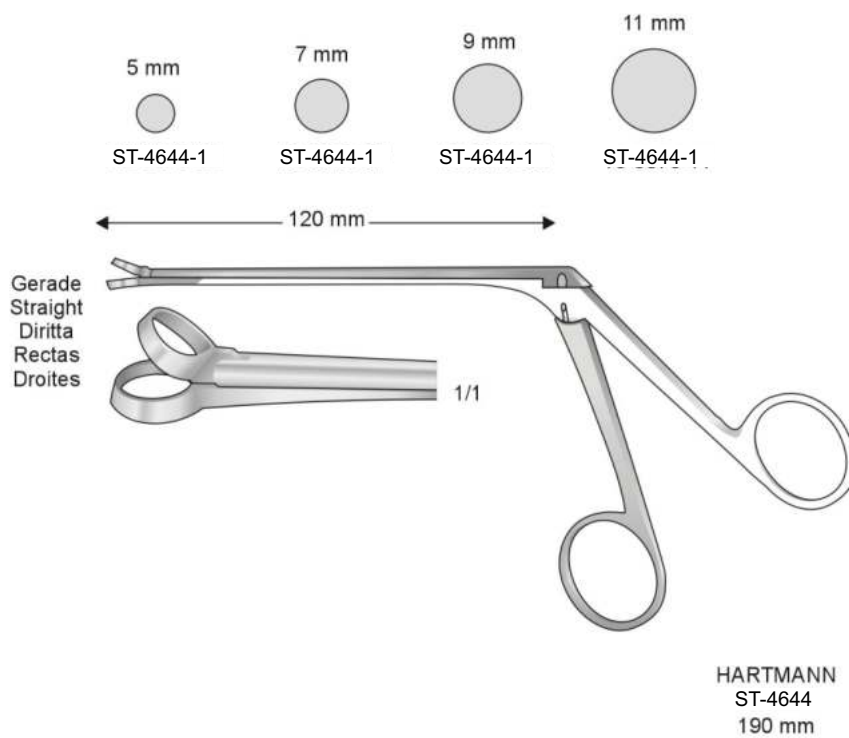
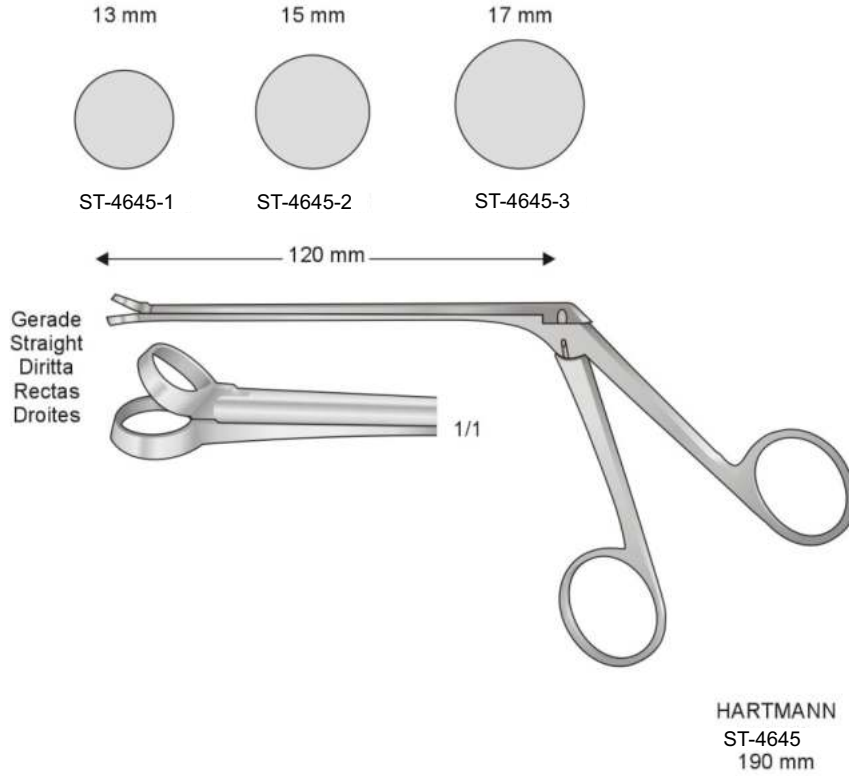
Von Kirschner-Drähten Ø 6 mm
For Kirschner wires Ø 6 mm
Per chiodi Kirschner Ø 6 mm



ST-4641
450 mm

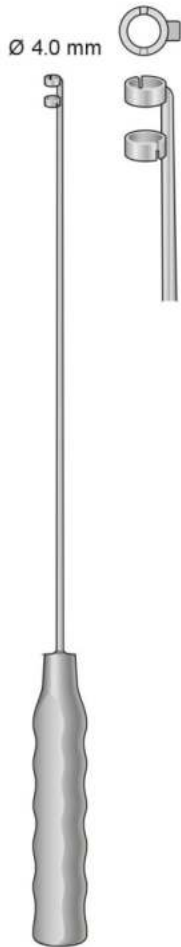


ST-4642
560 mm





Sehnenschäler
Tendon Stripper
Enucleatore per tendini
Enucleador de tendones
Décolleurs de tendons

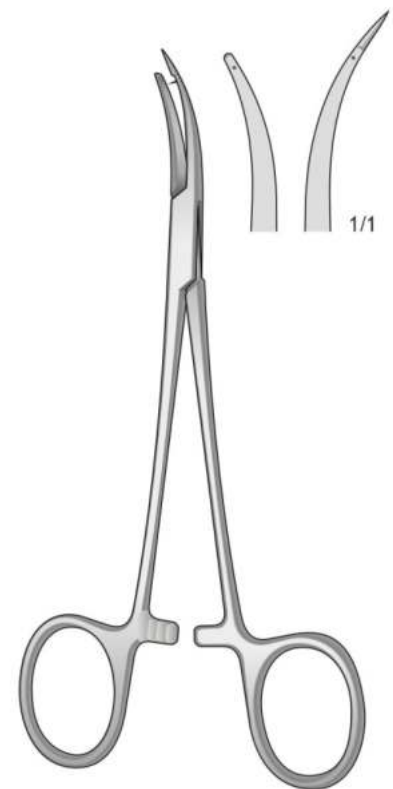


FISCHER
ST-4646
310 mm

Sehneneinflecht-klemmen - Tendon Interlacing Forceps
Pinze per intrecciare tendini - Pinzas para entrelazar tendones
Pincas pour entrelacer les tendons















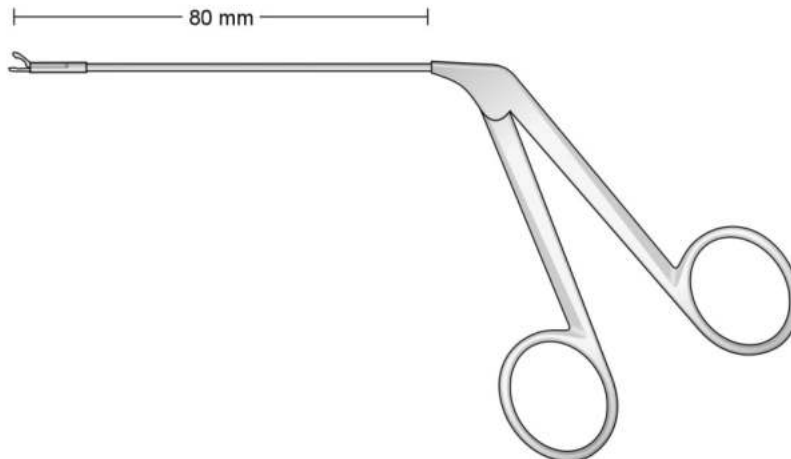
ST-4647
150 mm



ST-4648
150 mm

Rohrschaft. Mikro-Faßzängchen - Micro ear forceps with tubular shaft

Mikro-Löffelzängchen Micro cup shaped forceps Micro pinze a cucchiaio		Mikro-Scheren Micro scissors Micro forbici		
0,9 x 1,0 mm ○ Oval Ovale Ovales		ST-4649-1 Gerade - Straight Diritta - Recta Droit		BELLUCCI ST-4649-8 Gerade Straight Diritta Recta Droit
0,9 x 1,0 mm ○ Oval Ovale Ovales		ST-4649-2 Nach Oben Gebogen Curved up Curva in alto		BELLUCCI ST-4649-9 Nach Oben Gebogen Curved up Curva in alto
0,8 x 1,3 mm ○ Oval Ovale Ovales		WULLSTEIN ST-4649-3 Gerade - Straight Diritta - Recta Droit		BELLUCCI ST-4649-10 Links Gebogen Curved to left Curva a sinistra Curvas a la izquierda Courbes à gauche
0,8 x 1,3 mm ○ Oval Ovale Ovales		WULLSTEIN ST-4649-4 Links Gebogen - Curved to left Curva a sinistra - Curvas a la izquierda Courbes à gauche		BELLUCCI ST-4649-11 Rechts Gebogen Curved to right Curva a destra Curvas a la derecha Courbes à droite
0,8 x 1,3 mm ○ Oval Ovale Ovales		WULLSTEIN ST-4649-5 Rechts Gebogen - Curved to right Curva a destra - Curvas a la derecha Courbes à droite		BELLUCCI ST-4649-12 Orizzontale
1,0 mm ○ Rund Round Tonda		WULLSTEIN ST-4649-6 Gerade - Straight Diritta - Recta Droit		
1,7 x 2,5 mm ○ Oval Ovale Ovales		WULLSTEIN ST-4649-7 Gerade - Straight Diritta - Recta Droit		



ST-4649
80 mm

0,6 x 0,5 mm



ST-4650-1
Gerade
Straight
Diritta
Recta
Droit

0,9 x 1,1 mm



ST-4650-5
Gerade
Straight
Diritta
Recta
Droit

0,6 x 0,5 mm



ST-4650-2
Links Gebogen
Curved to left
Curva a sinistra
Curvas a la izquierda
Courbes à gauche

0,9 x 1,1 mm



ST-4650-6
Links Gebogen
Curved to left
Curva a sinistra
Curvas a la izquierda
Courbes à gauche

0,6 x 0,5 mm



ST-4650-3
Rechts Gebogen
Curved to right
Curva a destra
Curvas a la derecha
Courbes à droite

0,9 x 1,1 mm



ST-4650-7
Rechts Gebogen
Curved to right
Curva a destra
Curvas a la derecha
Courbes à droite

0,6 x 0,5 mm



ST-4650-4
Nach Oben Gebogen
Curved up
Curva in alto

0,9 x 1,1 mm



ST-4650-8
Nach Oben Gebogen
Curved up
Curva in alto

0,9 x 1,1 mm

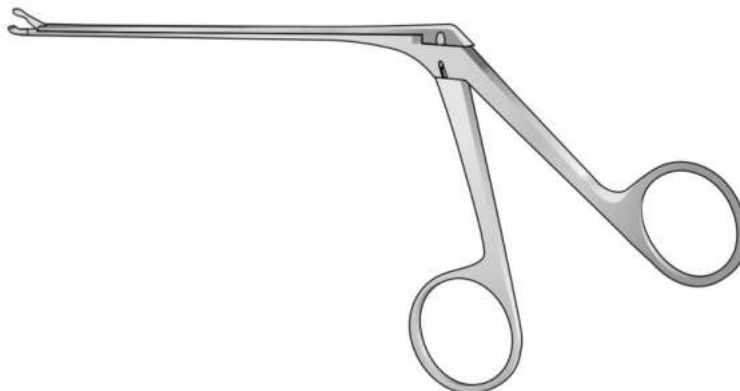


ST-4650-9
Nach Unten Gebogen
Curved down
Curva in basso

Schaft zerlegbar
Dismantable shaft
Asta smontabile
Vástago desmontable
Tige démontable

80 mm

Superfein
Extremely delicate
Modello super fine
Superfina
Modèle superfin



ST-4650
80 mm

6,0 x 0,8 mm



SCHUKNECHT

ST-4651-1
Gerade
Straight
Diritta
Recta
Droit

4,0 x 0,5 mm



ST-4651-5
Rechts Gebogen
Curved to right
Curva a destra
Curvas a la derecha
Courbes à droite

5,0 x 0,8 mm



GREVEN
ST-4651-2
Gerade
Straight
Diritta
Recta
Droit

4,0 x 0,5 mm



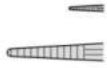
ST-4651-6
Links Gebogen
Curved to left
Curva a sinistra
Curvas a la izquierda
Courbes à gauche

4,0 x 0,5 mm



ST-4651-3
Gerade
Straight
Diritta
Recta
Droit

4,0 x 0,5 mm



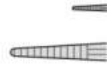
ST-4651-7
Nach Oben Gebogen
Curved up
Curva in alto

4,0 x 0,5 mm



ST-4651-4
Glattes Maul
Smooth jaws
Morso liscio
Mandibula lisa
Mors lisses

4,0 x 0,5 mm



ST-4651-8
Nach Unten Gebogen
Curved down
Curva in basso

Schaft zerlegbar
Dismantable shaft
Asta smontabile
Vástago desmontable
Tige démontable

Superfein
Extremely delicate
Modello super fine
Superfina
Modèle superfin

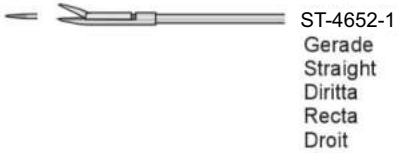
80 mm



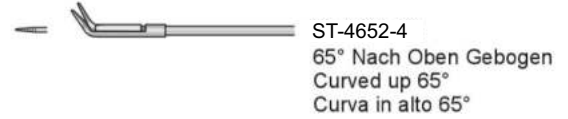
ST-4651
80 mm

Rohrschaft. Mikro-Faßzängchen
Micro ear forceps with tubular shaft

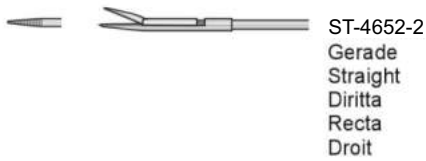
0,8 x 3,5 mm



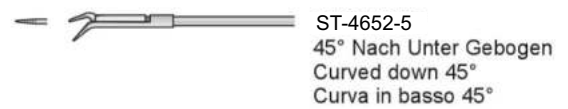
0,8 x 3,5 mm



1,0 x 5,0 mm



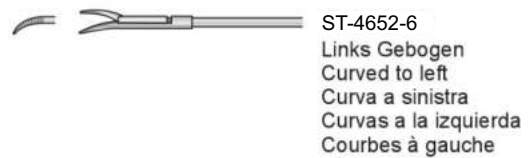
0,8 x 3,5 mm



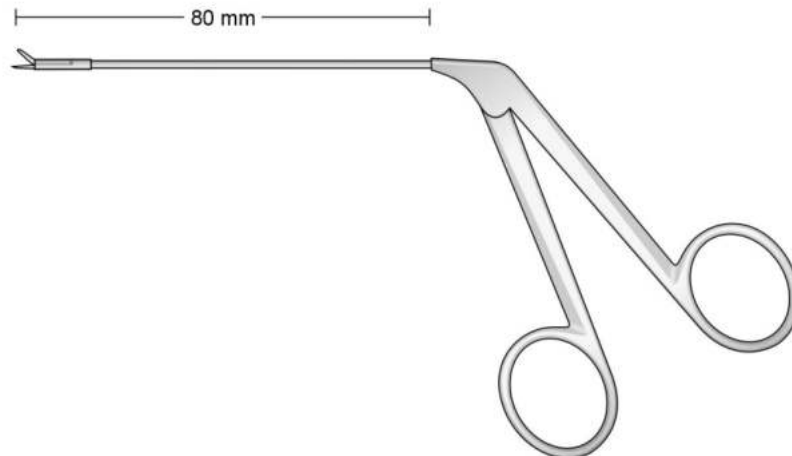
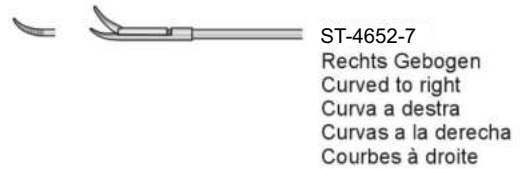
1,5 x 6,0 mm



1,0 x 5,0 mm



1,0 x 5,0 mm



ST-4652
80 mm



ST-4653-1
Gerade
Straight
Rette
Rectas
Droits



ST-4653-2
Gerade, horizontal schneidend
Straight, horizontally cutting
Rette, taglio orizzontale
Rectas, de corte horizontal
Droits, à coupe horizontale



ST-4653-3
Nach links gebogen
Curved to left
Curve a sinistra
Acodadas hacia la izquierda
Courbes à gauche



ST-4653-4
Nach rechts gebogen
Curved to right
Curve a destra
Acodadas hacia la derecha
Courbes à droite



ST-4653-5
Nach oben abgewinkelt
Angled up
Angolate in alto
Angulada hacia arriba
Coudés vers le haut



ST-4653-6
Nach unten abgewinkelt
Angled down
Angolate in basso
Angulada hacia abajo
Coudés vers le bas



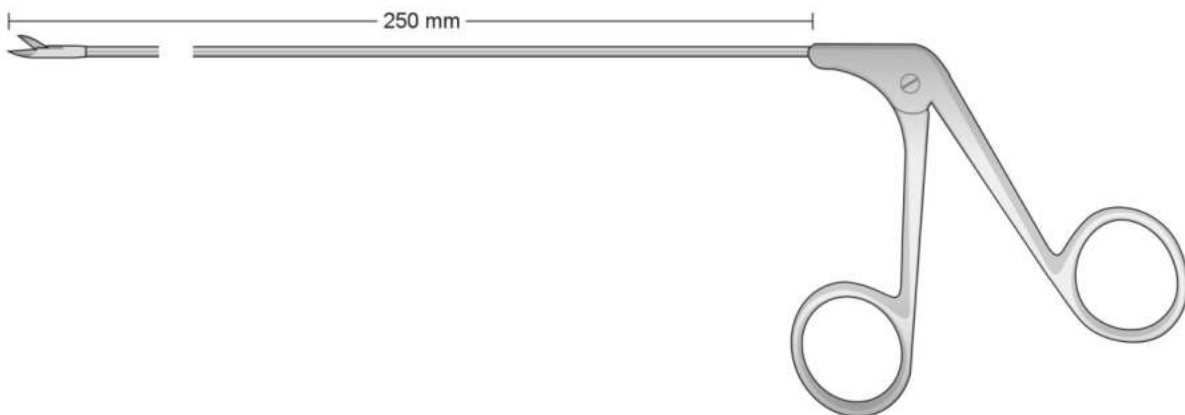
ST-4653-7
Gerefties maul, gerade
Serrated jaws, straight
Morsi zigrinati, retti
Boca estriada, recta
Mors striés, droits



ST-4653-8
Gerefties maul, rechts gebogen
Serrated jaws, right
Morsi zigrinati, curvi a destra
Boca estriada, curva a la derecha
Mors striés, courbes à droite



ST-4653-9
Gerefties maul, links gebogen
Serrated jaws, left
Morsi zigrinati, curvi a sinistra
Boca estriada, curva a la izquierda
Mors striés, courbes à gauche



ST-4653
250 mm



ST-4654-1
Rundes Löffelmaul, gerade
Round cup jaws, straight
Morso a forma di cucchiaio rotondo, retto
Boca redonda en forma de cucharilla, recta
Mors ronds en cuiller, droits



ST-4654-2
Rundes Löffelmaul, nach oben
Round cup jaws, up
Morso a forma di cucchiaio rotondo, in alto
Boca redonda en forma de cucharilla, arriba
Mors ronds en cuiller, courbes en haut



ST-4654-3
Rundes Löffelmaul, rechts
Round cup jaws, right
Morso a forma di cucchiaio rotondo, destra
Boca redonda en forma de cucharilla, a la derecha
Mors ronds en cuiller, courbes à droite



ST-4654-4
Rundes Löffelmaul, links
Round cup jaws, left
Morso a forma di cucchiaio rotondo, sinistra
Boca redonda en forma de cucharilla, a la izquierda
Mors ronds en cuiller, courbes à gauche



ST-4654-5
Ovales Löffelmaul, gerade
Oval cup jaws, straight
Morso a forma di cucchiaio ovale, retto
Boca ovalada en forma de cucharilla, recta
Mors ovales en cuiller, droits



ST-4654-6
Ovales Löffelmaul, nach oben
Oval cup jaws, up
Morso a forma di cucchiaio ovale, in alto
Boca ovalada en forma de cucharilla, arriba
Mors ovales en cuiller, courbes en haut



ST-4654-7
Ovales Löffelmaul, rechts
Oval cup jaws, right
Morso a forma di cucchiaio ovale, destra
Boca ovalada en forma de cucharilla, a la derecha
Mors ovales en cuiller, courbes à droite



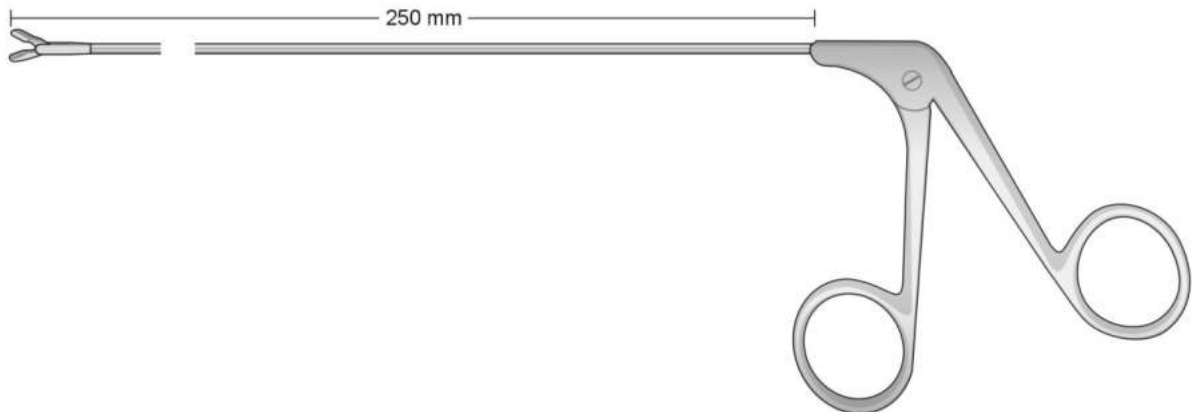
ST-4654-8
Ovales Löffelmaul, links
Oval cup jaws, left
Morso a forma di cucchiaio ovale, sinistra
Boca ovalada en forma de cucharilla, a la izquierda
Mors ovales en cuiller, courbes à gauche



ST-4654-9
Ovales Löffelmaul, gerade
Oval cup jaws, straight
Morso a forma di cucchiaio ovale, retto
Boca ovalada en forma de cucharilla, recta
Mors ovales en cuiller, droits

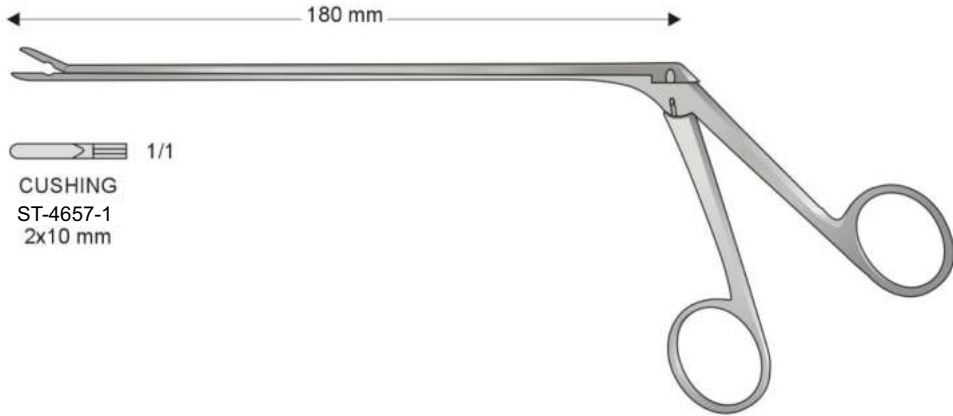


ST-4654-10
Maulteile gefenstert
Jaw fenestrated
Morso fenestrato
Boca fenestrada
Mors ajourés



ST-4654
250 mm

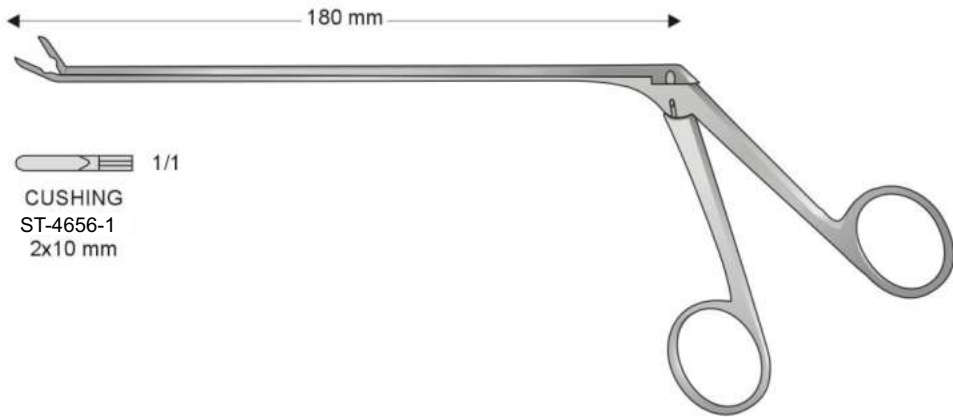
Gerade
Stright
Diritta
Rectas
Droites



1/1
CUSHING
ST-4657-1
2x10 mm

CUSHING
ST-4657

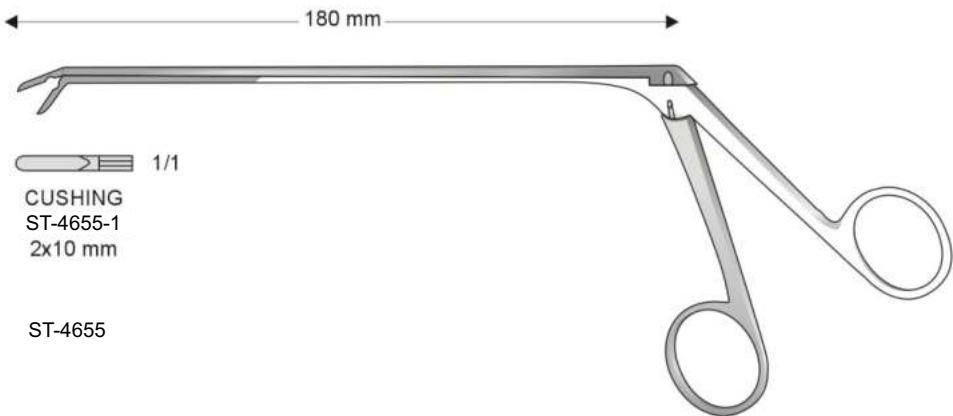
Aufwärtsgebogen
Top curved
Curva verso l'alto
Curvos
Courbe vers le haut



1/1
CUSHING
ST-4656-1
2x10 mm

CUSHING
ST-4656

Abwärts gebogen
Bottom curved
Curva verso il basso
Curvos
Courbe vers le bas



1/1
CUSHING
ST-4655-1
2x10 mm

ST-4655

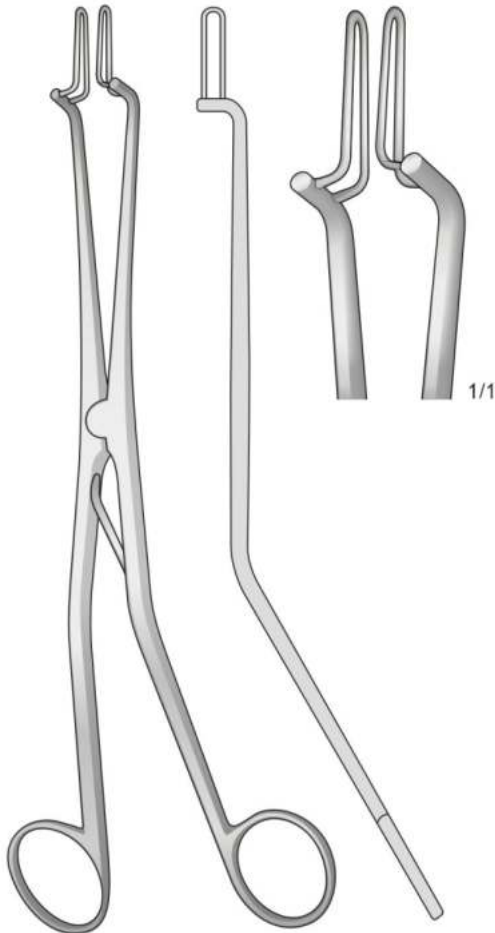
CUSHING
ST-4655



Katheter-Einführungsinstrumente
Catheter introducing instruments
Strumenti per tendere ed introdurre i cateteri
Instrumentos para introducir catéteres
Mandrin pour introduire les sondes

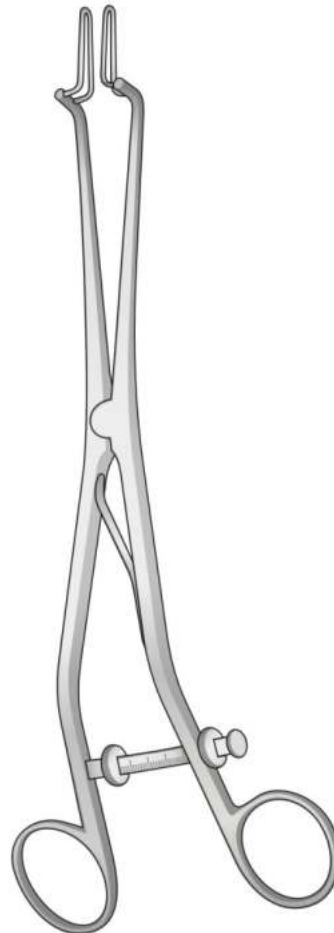
Ø 1,2 mm

Endospekula für Harnröhre und
Cervix, ohne Sperre
Endospecula for cervix and urethra,
without ratchet



KOGAN
ST-4658
240 mm

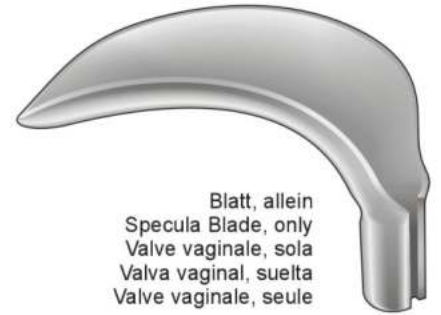
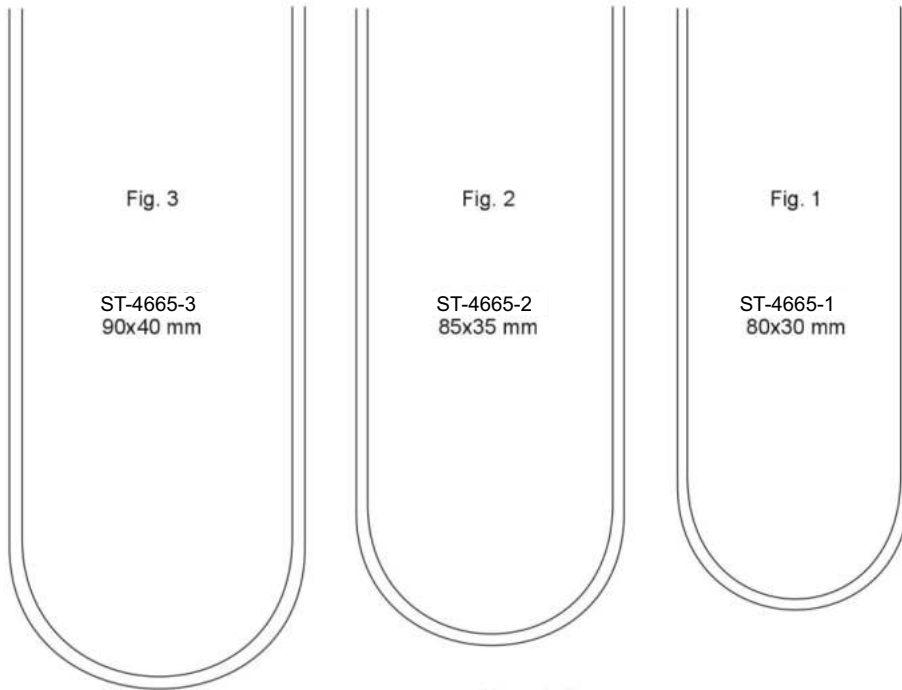
Endospekula für Harnröhre und
Cervix, mit Skalensperre und Fixierschraube
Endospecula for cervix and urethra,
with scale-ratchet and fixing screws
Con cremagliera a scala e vite di fissaggio
Con cremallera graduada y tornillo de fijación
Avec crémaillère à échelle et vis à fixation



KOGAN
ST-4659
240 mm



ST-4660
425 mm

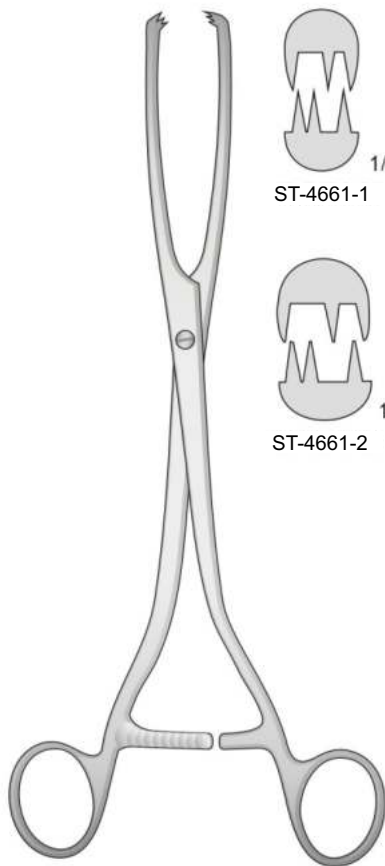


Blatt, allein
Specula Blade, only
Valve vaginale, sola
Valva vaginal, suelta
Valve vaginale, seule

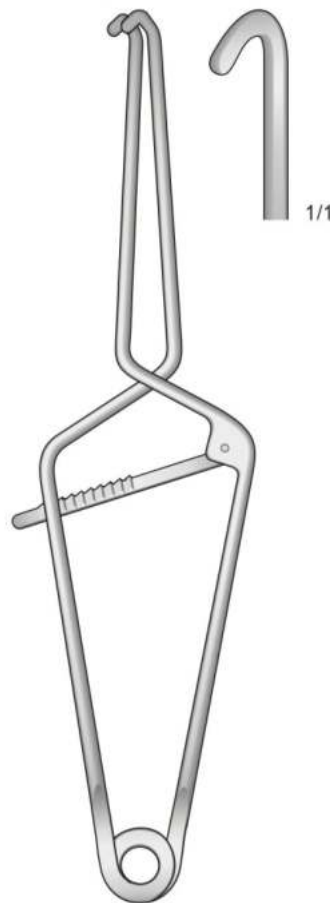
SCHERBAK
ST-4665

Blasenhalsperrer
Sounds Bladder
Dilatatore del collo vescicale
Sonda vesicales
Dilatateur pour le col vésical

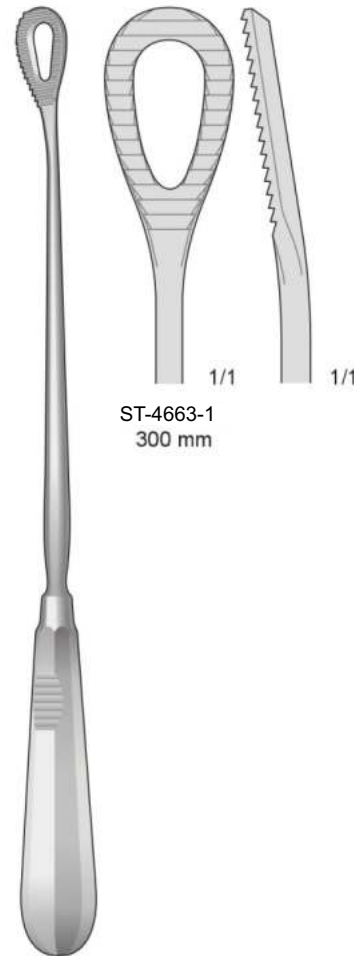
Biopsiekürette
Uterine Biopsy Curette
Curette per biopsia
Curettes para biopsia
Curettes pour biopsie



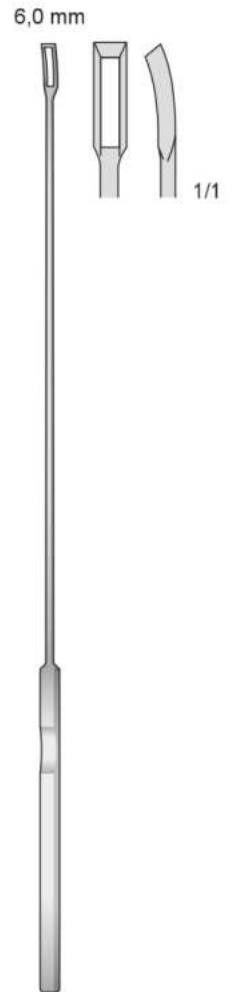
MUSEUX
ST-4661
265 mm



MILLIN
ST-4662
280 mm



PESTALOZZA
ST-4663
300 mm



KEVORKIAN
ST-4664
300 mm



Gewicht zum Vaginalsepekulum
Weight for Vaginal Speculum
Peso per specolo vaginale
Peso para espéculo vaginal
Poids pour spéculum vaginal



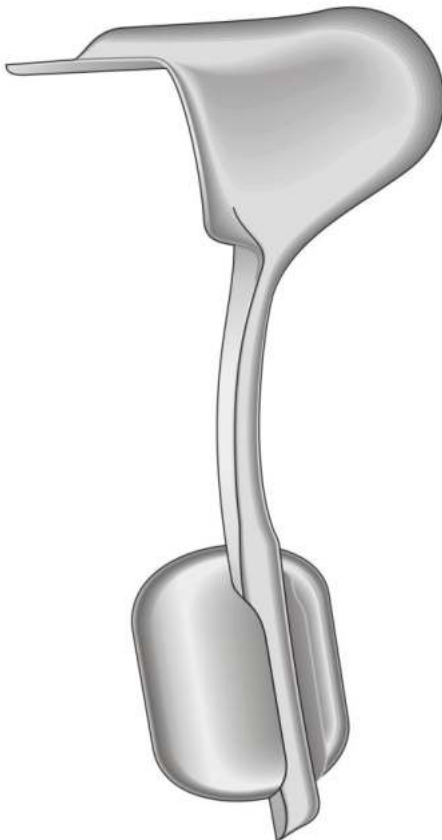
SCHERBAK
ST-4670-1 10,5 mm 400 gr
ST-4670-2 13 mm 800 gr

Blatt, allein
Specula Blade, only
Valve vaginale, sola
Valva vaginal, suelta
Valve vaginale, seule



SCHERBAK
ST-4669

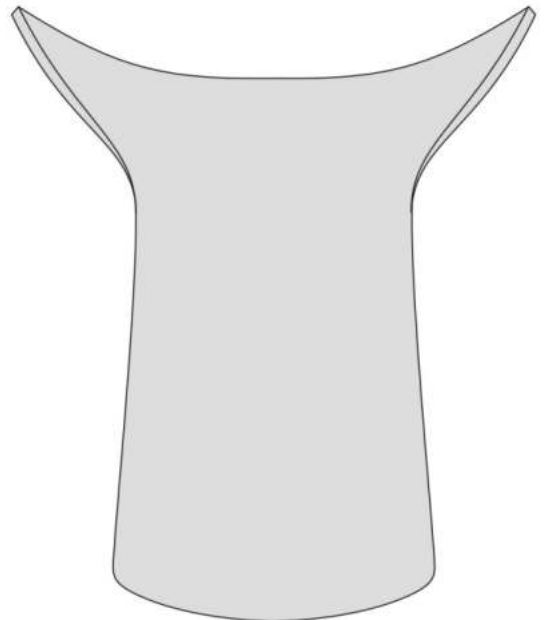
Griff zum Vaginalsepekulum
Handle for Vaginal Speculum
Manico per specolo vaginale
Mango para espéculo vaginal
Manche pour spéculum vaginal



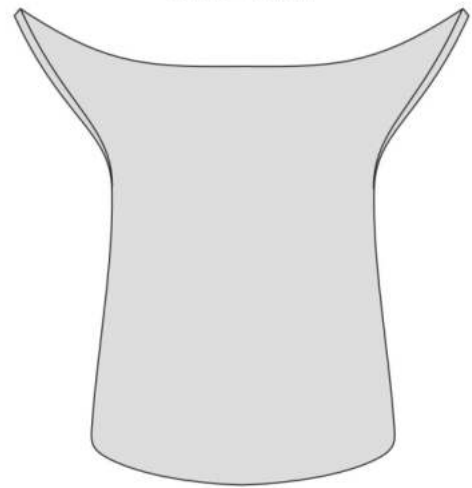
AUVARD
ST-4666
230 mm



SCHERBAK
ST-4667
200 mm



ST-4668-1
81x45 - 70 mm



ST-4668
62x40 - 60 mm



Geschwärzt
Surface Black-finish
Superficie anti-riflesso
Surface noircie



ST-4673
75 x 20 mm



ST-4671
100 x 22 mm



ST-4672
120 x 25 mm



ST-4680

Komplettset mit 14 Uterusdilatoren ohne Metalletui
Set con 14 dilatatori uterini senza scatola



ST-4681

Komplettset mit 26 Uterusdilatoren ohne Metalletui
Set con 26 dilatatori uterini senza scatola



ST-4678

Metalletui mit 14 Hegar Uterusdilatoren
Scatola con 14 dilatatori uterini Hegar



ST-4679

Metalletui mit 13 Hegar Uterusdilatoren
Scatola con 13 dilatatori uterini Hegar



ST-4676

mit 8 Uterusdilatoren
con 8 dilatatori uterini



ST-4677

für 8 Uterusdilatoren
per 8 dilatatori uterini



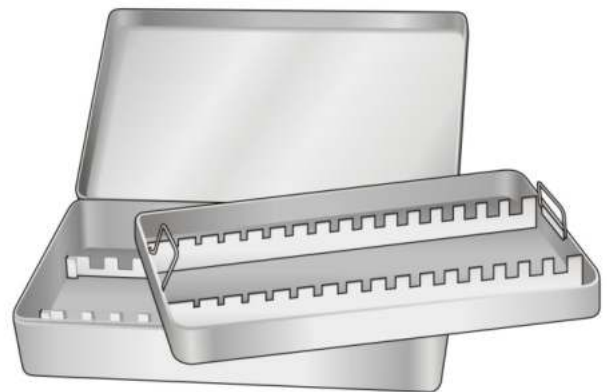
ST-4674

Metalletui mit 26 Hegar Uterusdilatoren
Scatola con 26 dilatatori uterini Hegar



ST-4675

Metalletui leer für 26 Hegar Uterusdilatoren
Scatola vuota per 26 dilatatori uterini Hegar



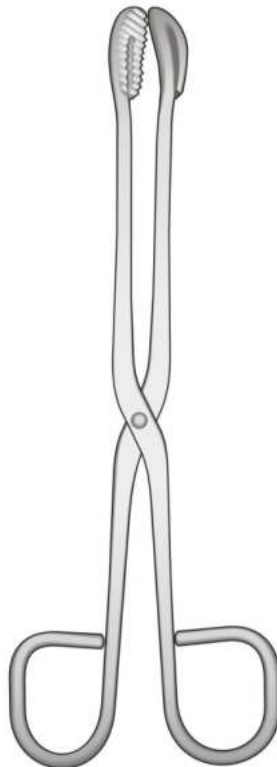


Uterusdepressor
Uterine Depressor
Depressore uterino
Depresor uterino
Dépresseur utérin



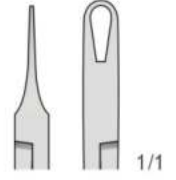
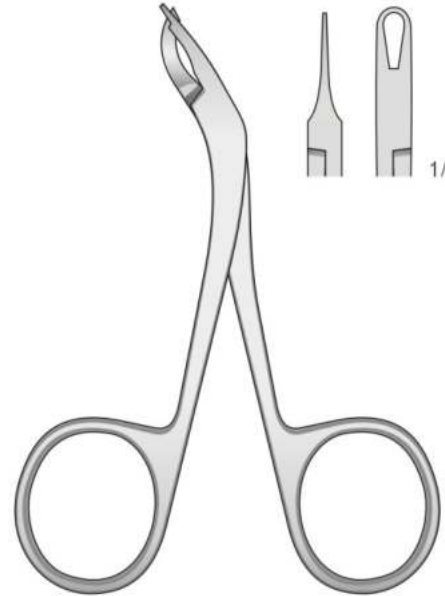
BRAUN
ST-4682
275 mm

Sterilisierzangen zum Fassen und Halten Steriler Instrumente
Sterilizing forceps for picking up and holding of sterile instruments
Pinze per prelevare strumenti sterilizzati
Pinzas para esterilizaci3n
Pinces pour instruments stérilisés



ST-4683 200 mm
ST-4683 300 mm

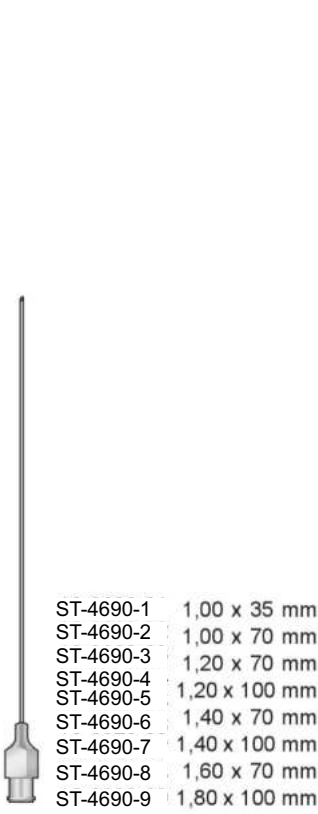
Pinza per rimozione punti metallici



ST-4685
115 mm

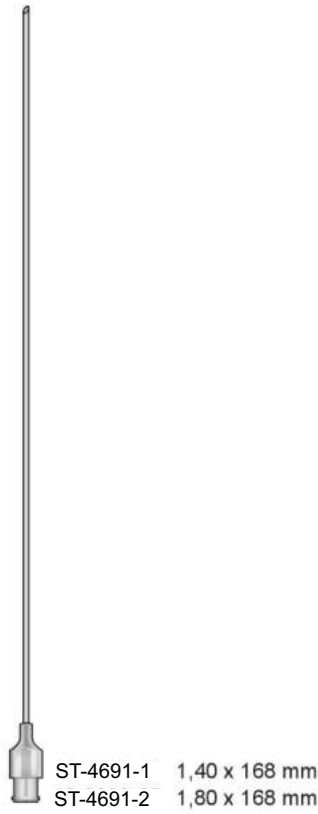


ST-4684
155 mm



- ST-4690-1 1,00 x 35 mm
- ST-4690-2 1,00 x 70 mm
- ST-4690-3 1,20 x 70 mm
- ST-4690-4 1,20 x 100 mm
- ST-4690-5 1,20 x 100 mm
- ST-4690-6 1,40 x 70 mm
- ST-4690-7 1,40 x 100 mm
- ST-4690-8 1,60 x 70 mm
- ST-4690-9 1,80 x 100 mm

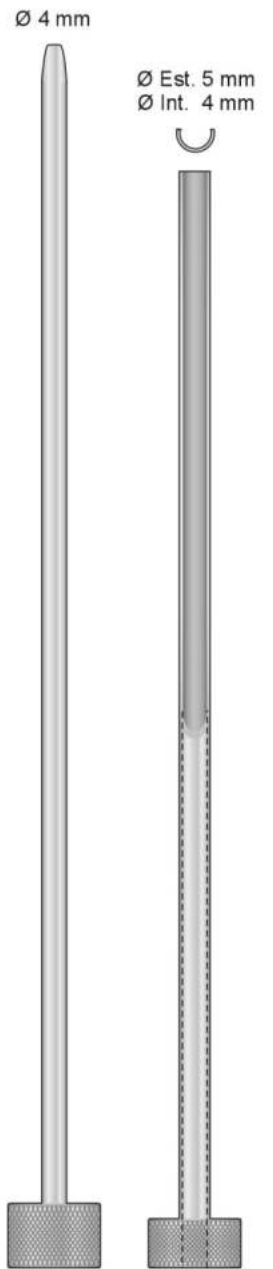
MENGHINI
ST-4690



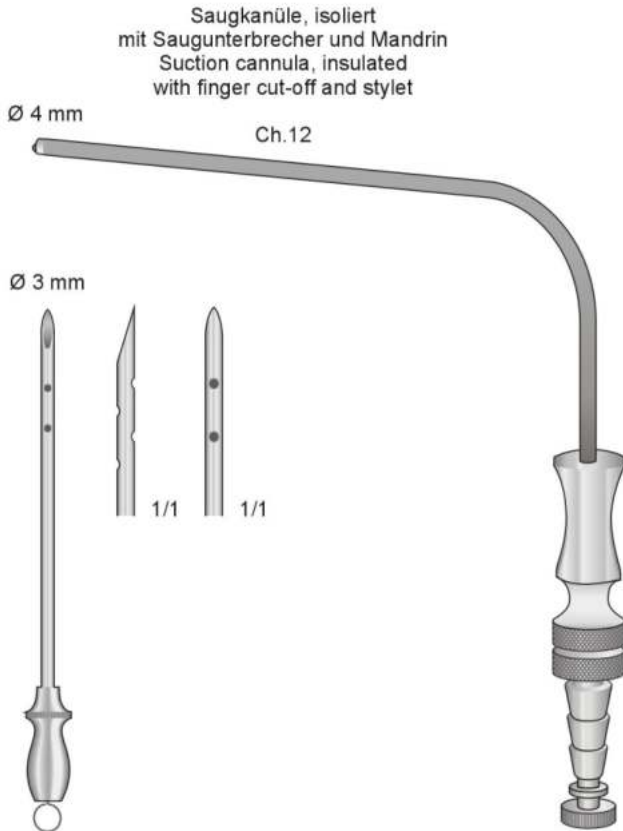
- ST-4691-1 1,40 x 168 mm
- ST-4691-2 1,80 x 168 mm

MENGHINI
ST-4691

Kanüle mit Trokardon
Trokar with mandrin
Cannula completa di mandrino
Canula con sonda de guida



ST-4689
200 mm



GILMET
ST-4686
85 mm

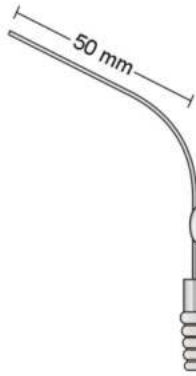
FERGUSON
ST-4687
150 mm



SEIFFERT
ST-4688
180 mm



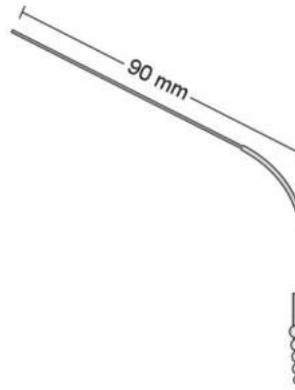
- Ø 1,5 mm
- Ø 1,7 mm
- Ø 2,0 mm



- ST-4696 Ø 1,5 mm
- ST-4696 Ø 1,7 mm
- ST-4696 Ø 2,0 mm

BARNES
ST-4696
100 mm

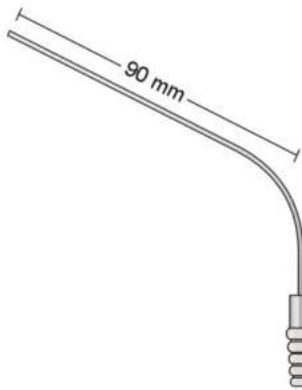
- Ø 1,0 mm
- Ø 1,5 mm



- ST-4697-1 Ø 1,0 mm
- ST-4697-2 Ø 1,5 mm

BARNES
ST-4697
125 mm

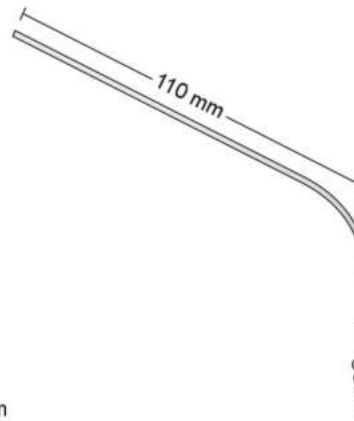
- Ø 2,0 mm



- ST-4694-1 Ø 2,0 mm

BARNES
ST-4694
125 mm

- Ø 3,0 mm
- Ø 4,0 mm
- Ø 5,0 mm



- ST-4695-1 Ø 3,0 mm
- ST-4695-2 Ø 4,0 mm
- ST-4695-3 Ø 5,0 mm

BARNES
ST-4695
150 mm

Ø 3,5 mm

Ø 2,0 mm

- ST-4693-1 Ø 2,0 mm / 3,5 mm
350 mm
- ST-4693-2 Ø 2,0 mm / 3,5 mm
500 mm

Olive
Ø 9 mm
ST-4693

250 mm

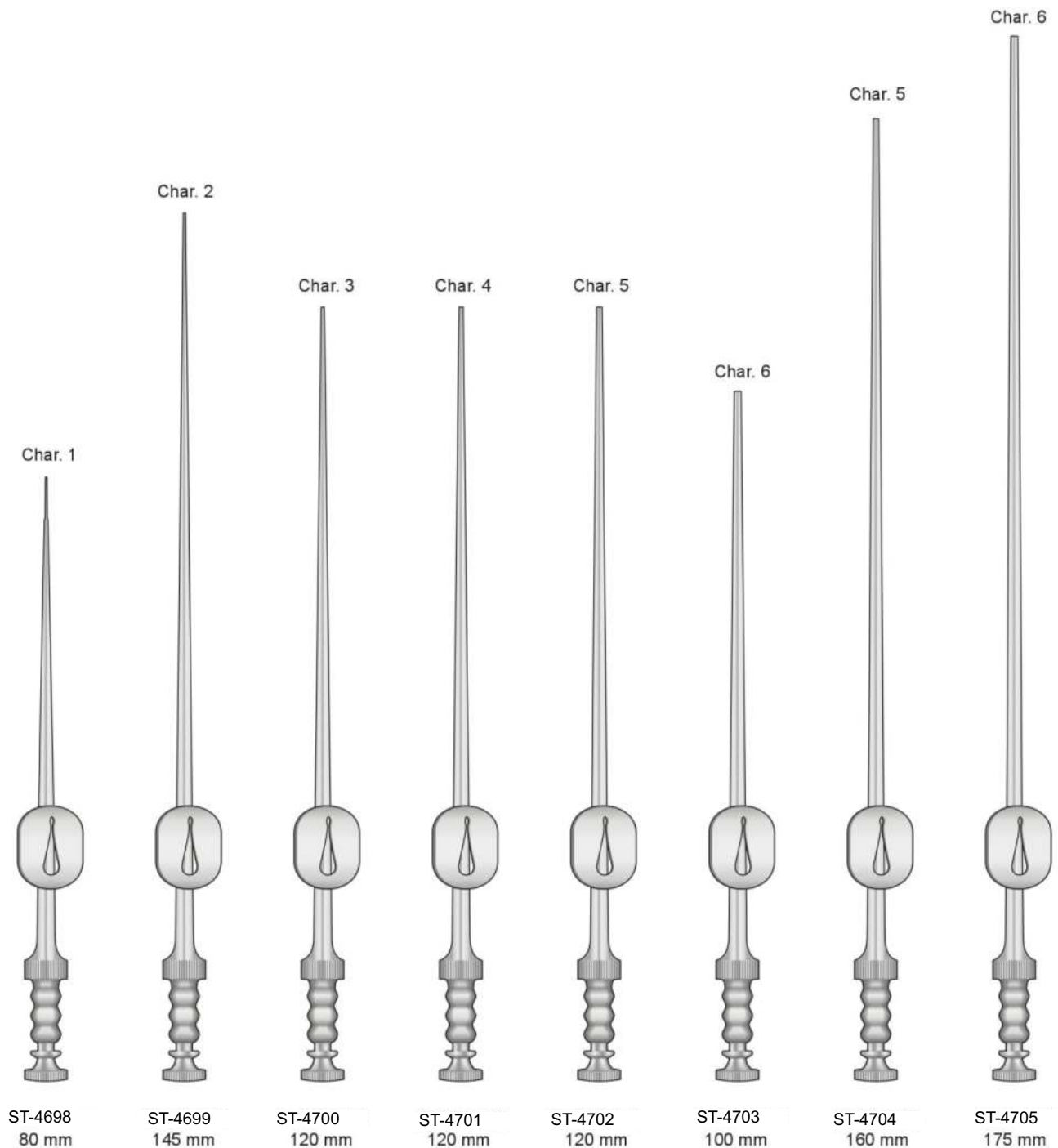
- ST-4692-1 Ø 2,0 mm
- ST-4692-1 Ø 2,5 mm
- ST-4692-1 Ø 3,0 mm

Olive
Ø 6-9 mm

ST-4692
250 mm

Lunghezza Cannula	No.1 0,6 x 0,4	No.2 0,8 x 0,6	No.3 1,0 x 0,8	No.4 1,2 x 1,0	No.5 1,5 x 1,2	No.6 2,0 x 1,6	
SS = 80 mm	ST-4698-1	ST-4698-2	ST-4698-3	ST-4698-4	ST-4698-5	ST-4698-6	For Bypass
S = 100 mm	ST-4699-1	ST-4699-2	ST-4699-3	ST-4699-4	ST-4699-5	ST-4699-6	
M = 120 mm	ST-4700-1	ST-4700-2	ST-4700-3	ST-4700-4	ST-4700-5	ST-4700-6	
L = 145 mm	ST-4701-1	ST-4701-2	ST-4701-3	ST-4701-4	ST-4701-5	ST-4701-6	
LL = 160 mm	ST-4702-1	ST-4702-2	ST-4702-3	ST-4702-4	ST-4702-5	ST-4702-6	For Trans-sphenoidal
LLL = 175 mm	ST-4703-1	ST-4703-2	ST-4703-3	ST-4698-4	ST-4703-5	ST-4703-6	For Trans-sphenoidal

Char. 1 = 0,3 mm
Char. 2 = 0,6 mm
Char. 3 = 1,0 mm
Char. 4 = 1,3 mm
Char. 5 = 1,6 mm
Char. 6 = 2,0 mm
Char. 7 = 2,3 mm
Char. 8 = 2,6 mm
Char. 9 = 3,0 mm
Char. 10 = 3,3 mm



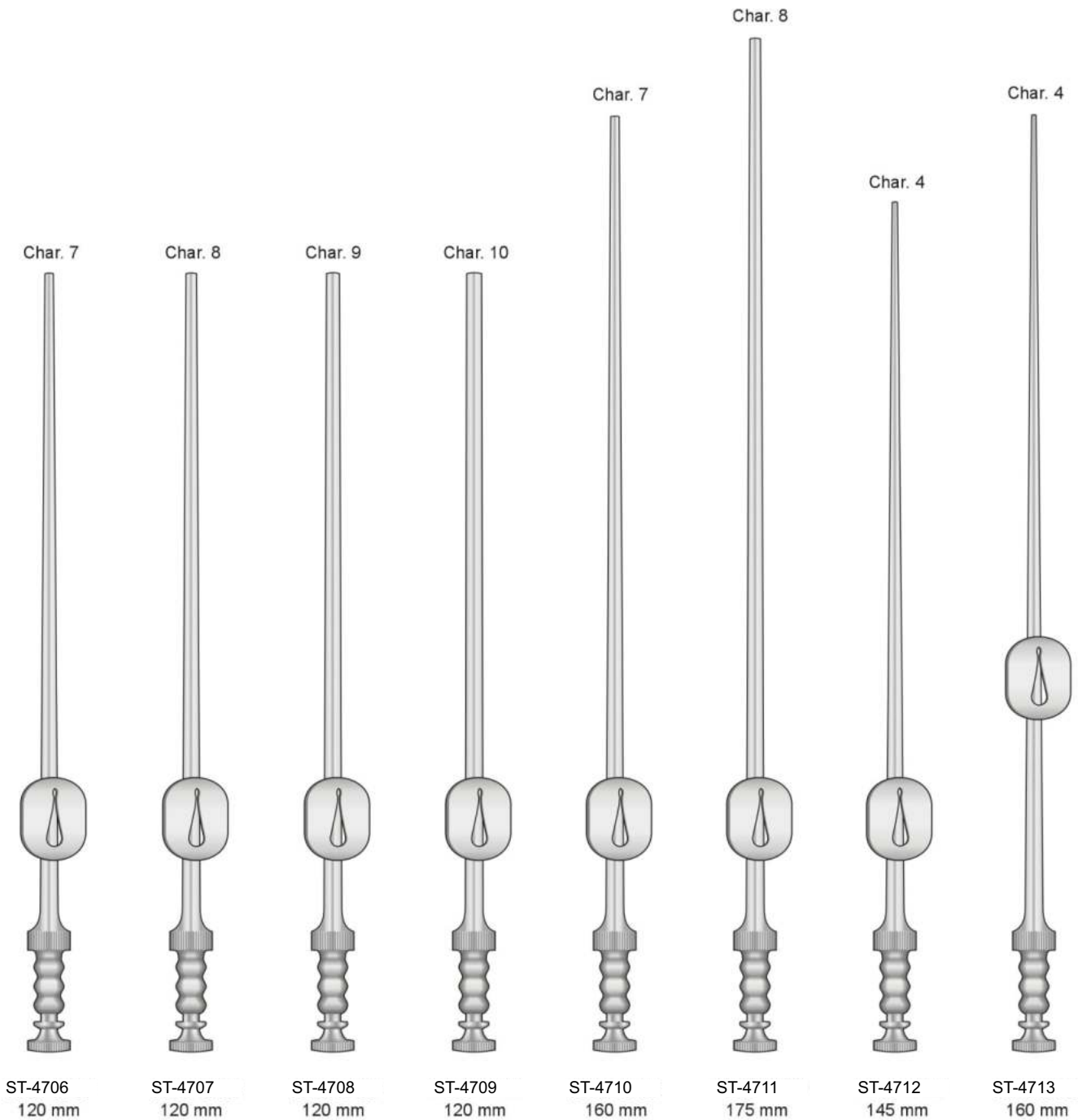
ST-4713

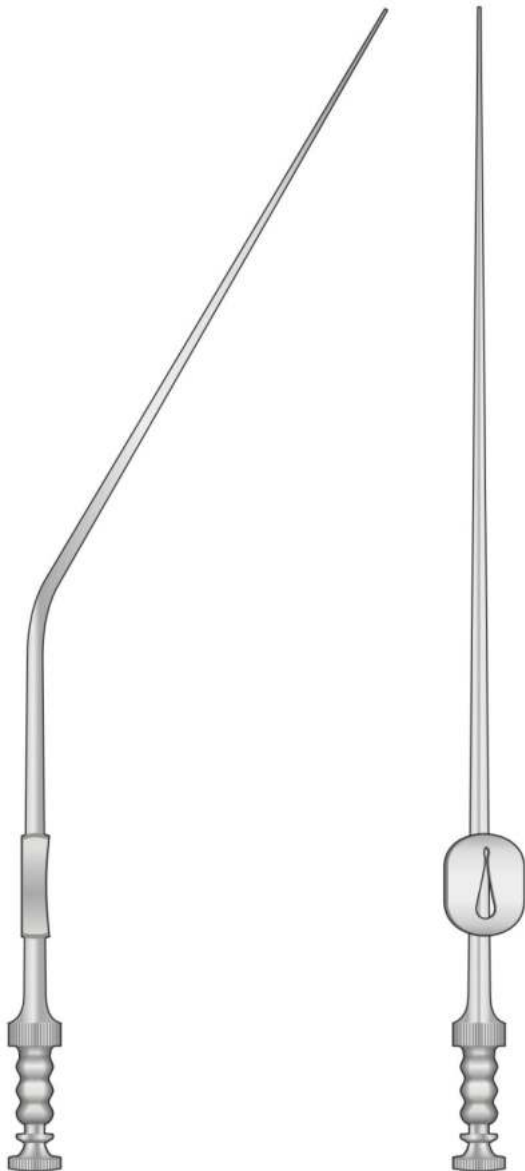
Lunghezza Cannula	No.7 2,5 x 1,9	No.8 3,0 x 2,2	No.9 3,5 x 2,5	No.10 4,0 x 3,0
M = 120 mm	ST-4706-1	ST-4706-2	ST-4706-3	ST-4706-4
L = 145 mm	ST-4707-1	ST-4707-2	ST-4707-3	ST-4707-4
LL = 160 mm	ST-4708-1	ST-4708-2	ST-4708-3	ST-4708-4
LLL = 175 mm	ST-4709-1	ST-4709-2	ST-4709-3	ST-4709-4

For Trans-sphenoidal

For Trans-sphenoidal

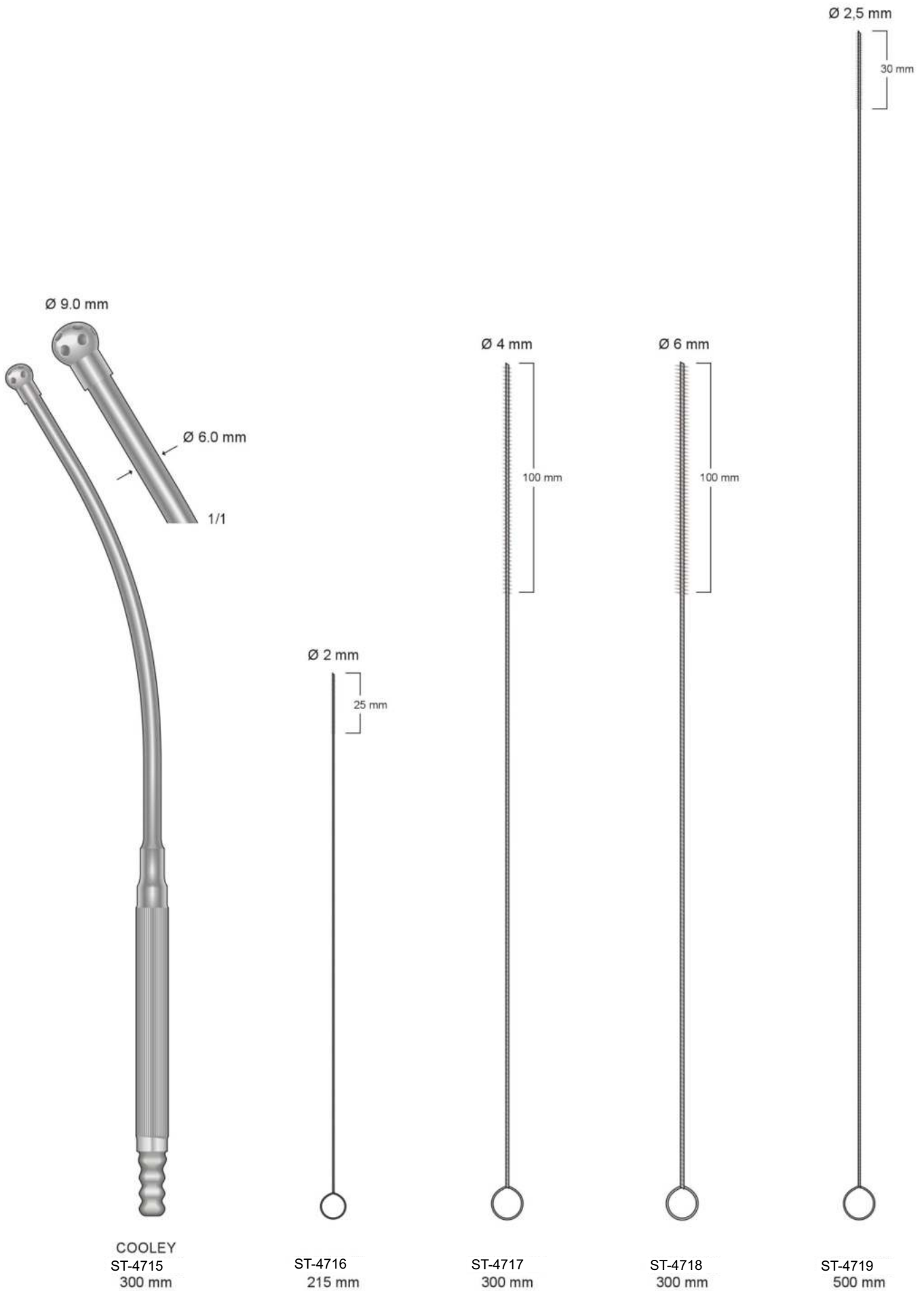
Char. 1 = 0,3 mm
Char. 2 = 0,6 mm
Char. 3 = 1,0 mm
Char. 4 = 1,3 mm
Char. 5 = 1,6 mm
Char. 6 = 2,0 mm
Char. 7 = 2,3 mm
Char. 8 = 2,6 mm
Char. 9 = 3,0 mm
Char. 10 = 3,3 mm





Char. 3	= 1,0 mm
Char. 4	= 1,3 mm
Char. 5	= 1,6 mm
Char. 6	= 2,0 mm
Char. 7	= 2,3 mm
Char. 8	= 2,6 mm
Char. 9	= 3,0 mm
Char. 10	= 3,3 mm
Char. 11	= 3,6 mm
Char. 12	= 4,0 mm

	Lunghezza 160 mm	Lunghezza 180 mm	Lunghezza 205 mm
Char. 3	ST-4714-1	ST-4714-11	ST-4714-21
Char. 4	ST-4714-2	ST-4714-12	ST-4714-22
Char. 5	ST-4714-3	ST-4714-13	ST-4714-23
Char. 6	ST-4714-4	ST-4714-14	ST-4714-24
Char. 7	ST-4714-5	ST-4714-15	ST-4714-25
Char. 8	ST-4714-6	ST-4714-16	ST-4714-26
Char. 9	ST-4714-7	ST-4714-17	ST-4714-27
Char. 9	ST-4714-8	ST-4714-18	ST-4714-28
Char. 10	ST-4714-9	ST-4714-19	ST-4714-29
Char. 11	ST-4714-10	ST-4714-20	ST-4714-30
Char. 12			



mm: Schnittlänge
Length of blades
Lunghezza della lama
Largo de hojas
Longueur de la lame

Metallheft
Metal handle
Manico in metallo
Mango metálico
Manche métal

Holzheft
Wooden handle
Manico in legno
Mango de madera
Manche bois

Metallheft
Metal handle
Manico in metallo
Mango metálico
Manche métal

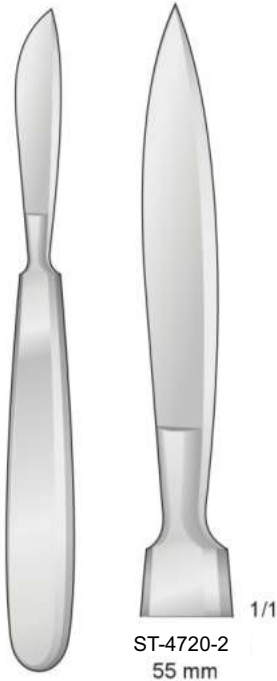
Metallheft
Metal handle
Manico in metallo
Mango metálico
Manche métal

Resektionsmesser
Resection knives
Coltello per resezione
Cuchillos para resección
Couteaux à résection

Organmesser
Post mortem knives
Coltello per autopsia
Cuchillos para órganos
Couteaux à autopsie

Organmesser
Post mortem knives
Coltello per autopsia
Cuchillos para órganos
Couteaux à autopsie

Hirnmesser
Brain knives
Coltello per cervello
Cuchillos para cerebro
Couteaux à cerveau



LANGENBECK
ST-4720
55 mm

ST-4721
110 mm

ST-4722
170 mm

ST-4723
195 mm

VIRCHOW
ST-4724
160 mm

VIRCHOW
ST-4725
200 mm

VIRCHOW
ST-4726
240 mm

Dermatome komplett mit 1 auswechselbarer Klinge und 2 Spannplatten
 Dermatome complete with 1 interchangeable blade and 2 skin plates
 Dermatomo a mano, con una lama intercambiabile, completo di 2 placche per stendere la pelle
 Dermatomo completo, con 1 hoja intercambiabile y 2 placas para extender la piel
 Dermatome avec 1 lame interchangeable et 2 plaques pour tendre la peau

Einstellbar von 0,1 bis 3,0 mm
 Adjustable from 0,1 to 3,0 mm
 Regolazione da 0,1 a 3,0 mm
 Regulable de 0,1 hasta 3,0 mm
 Réglable en épaisseur de 0,1 à 3,0 mm

Einstellbar von 0,1 bis 4,0 mm
 Adjustable from 0,1 to 4,0 mm
 Regolazione da 0,1 a 4,0 mm
 Regulable de 0,1 hasta 4,0 mm
 Réglable en épaisseur de 0,1 à 4,0 mm

Für handelsübliche Rasierklingen
 For usual razor blades
 Per lamette standard
 Para hojas de afeitar usuales
 Pour lames de rasoir modèle standard

Spanplatte
 Skin Fixing Plate
 Placca per stendere la pelle
 Placa para extender la piel
 Plaque pour tendre la peau



SCHINK
ST-4727

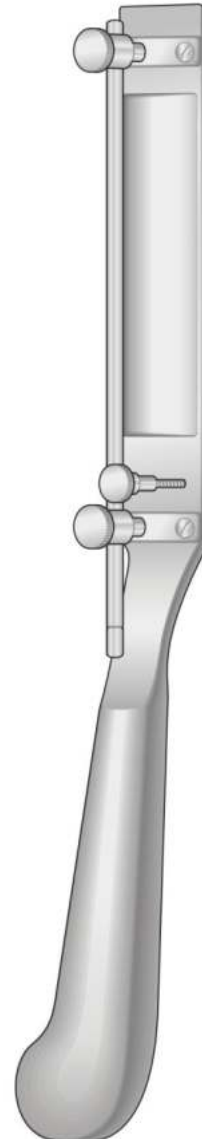


SILVER
ST-4728
190 mm

Ersatzklinge, allein
 Spare Blade only
 Lama di ricambio sola
 Hoja de repuesto
 Lame de rechange, seule



SILVER
ST-4729
43 mm



SCHINK
ST-4730
300 mm

Ersatzklinge, allein
 Spare Blade only
 Lama di ricambio sola
 Hoja de repuesto
 Lame de rechange, seule



SCHINK
ST-4731
102 mm



Dermatome komplett mit 1 auswechselbarer Klinge und 2 Spannplatten

Dermatome complete with 1 interchangeable blade and 2 skin plates

Dermatomo a mano, con una lama intercambiabile, completo di 2 placche per stendere la pelle

Dermatomo completo, con 1 hoja intercambiabile y 2 placas para extender la piel

Dermatome avec 1 lame interchangeable et 2 plaques pour tendre la peau

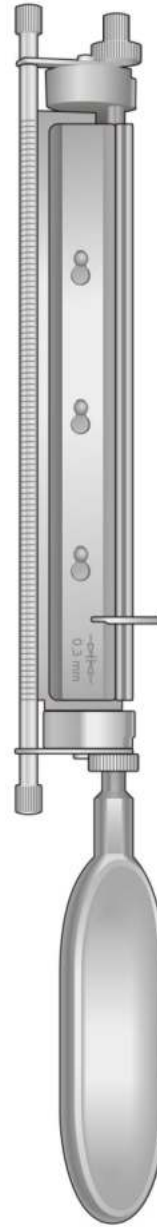
Einstellbar von 0,1 bis 1,5 mm
Adjustable from 0,1 to 1,5 mm
Regolazione da 0,1 a 1,5 mm
Regulable de 0,1 hasta 1,5 mm
Réglable en épaisseur de 0,1 à 1,5 mm



WATSON
ST-4732
300 mm



COBBETT
ST-4733
300 mm

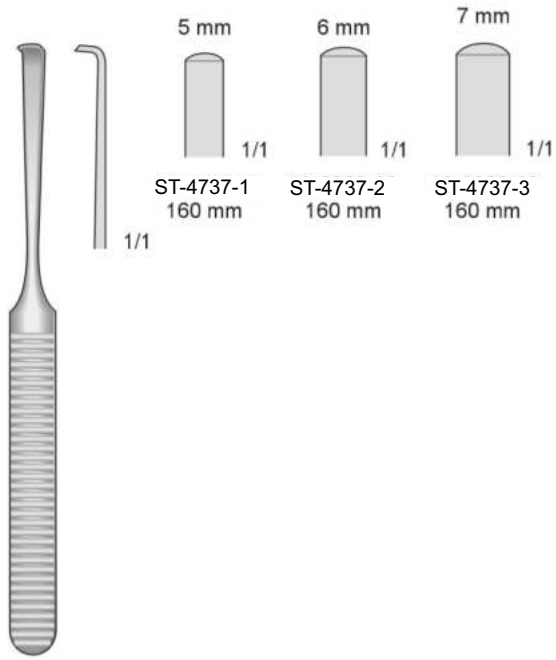


HUMBY
ST-4734
320 mm

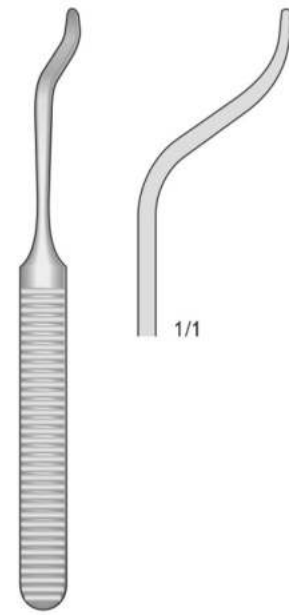
Ersatzklinge, allein
Spare Blade only
Lama di ricambio sola
Hoja de repuesto
Lame de rechange, seule



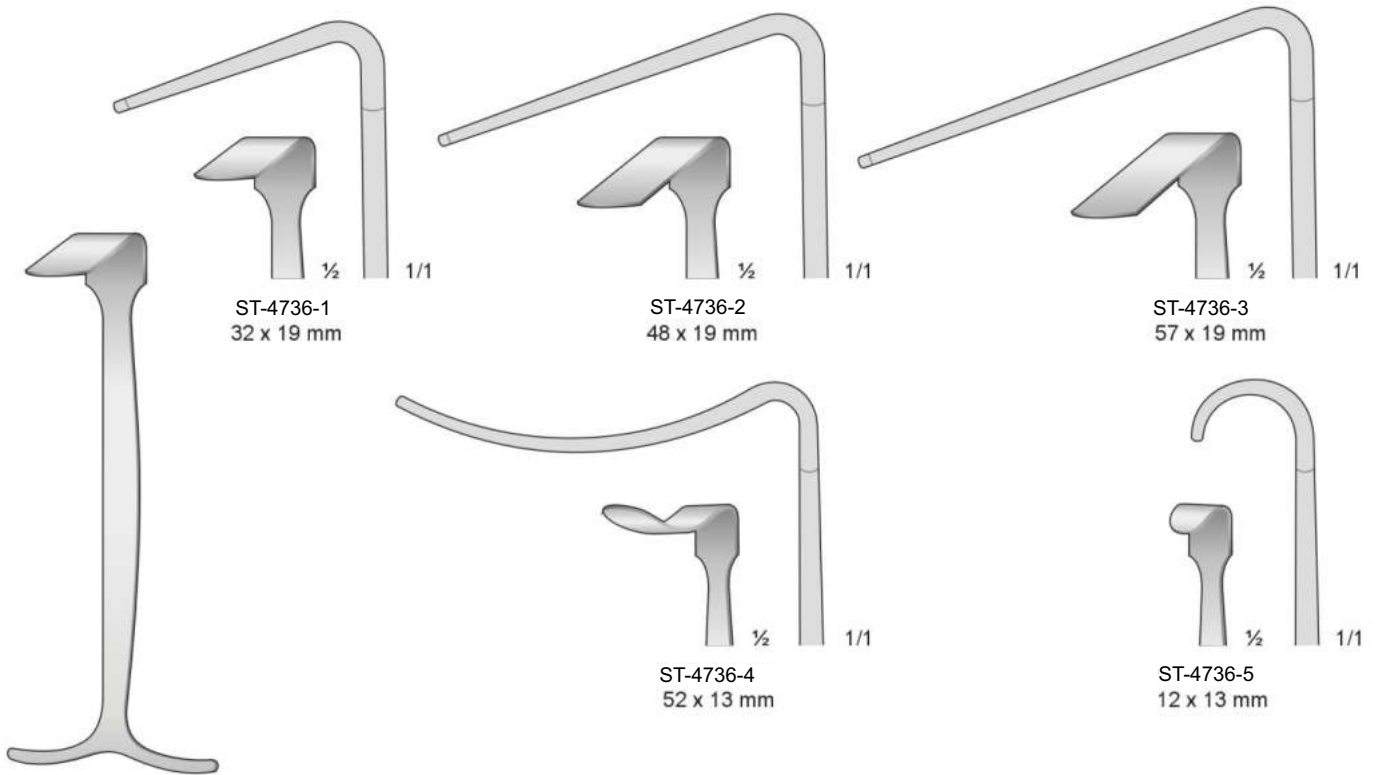
HUMBY
ST-4735
157 mm



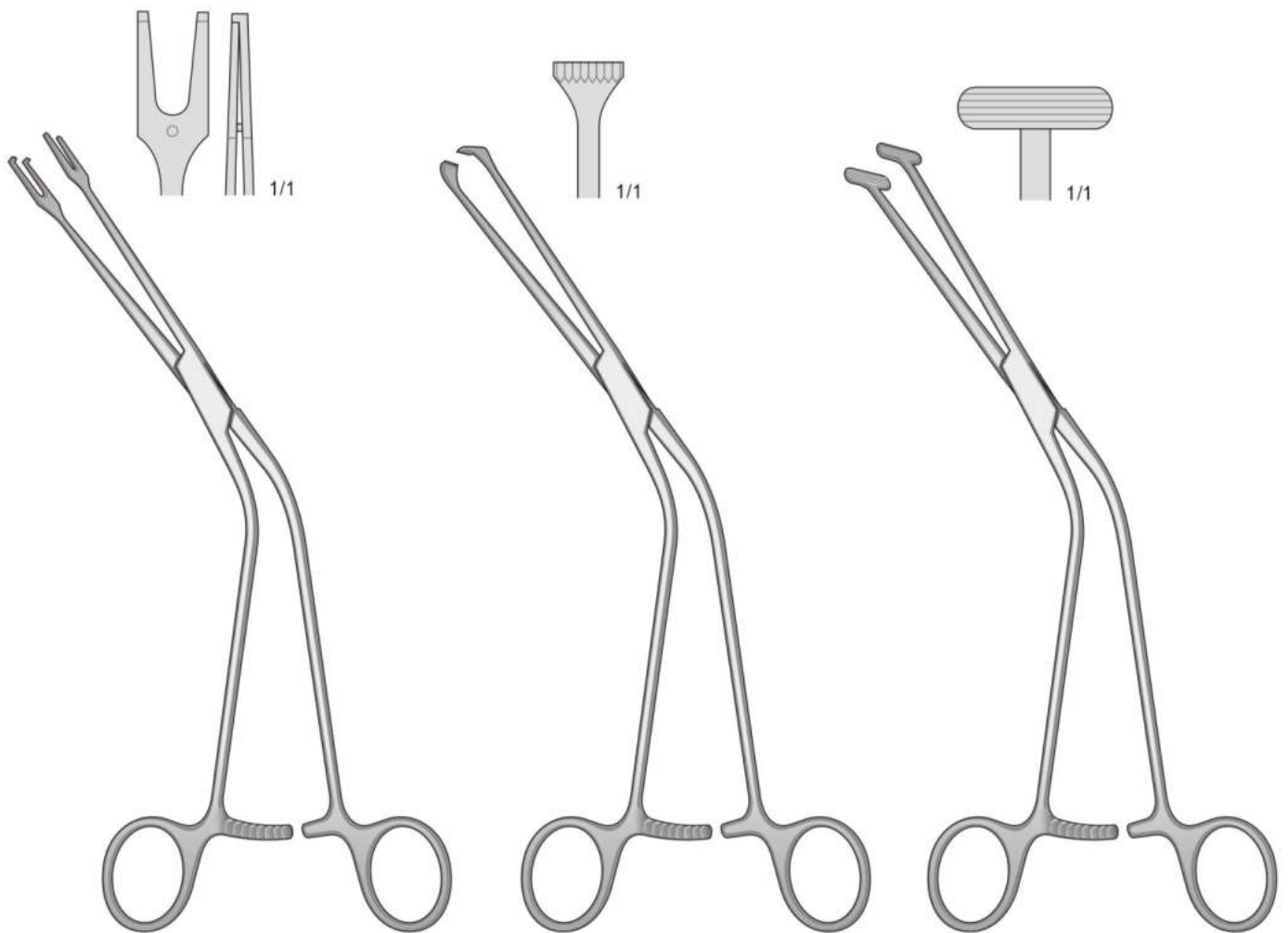
ST-4737
160 mm



ST-4738
160 mm



SMILLIE
ST-4736
140 mm



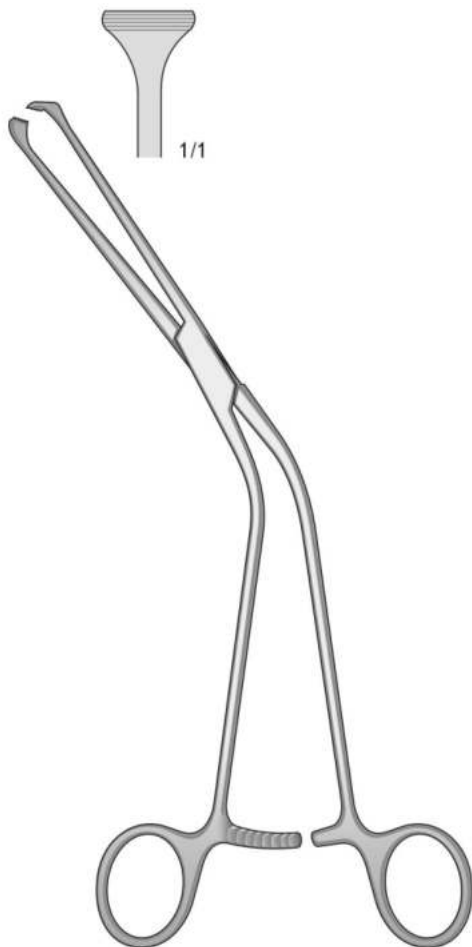
MILLIN
ST-4739
245 mm

MILLIN
ST-4740
220 mm

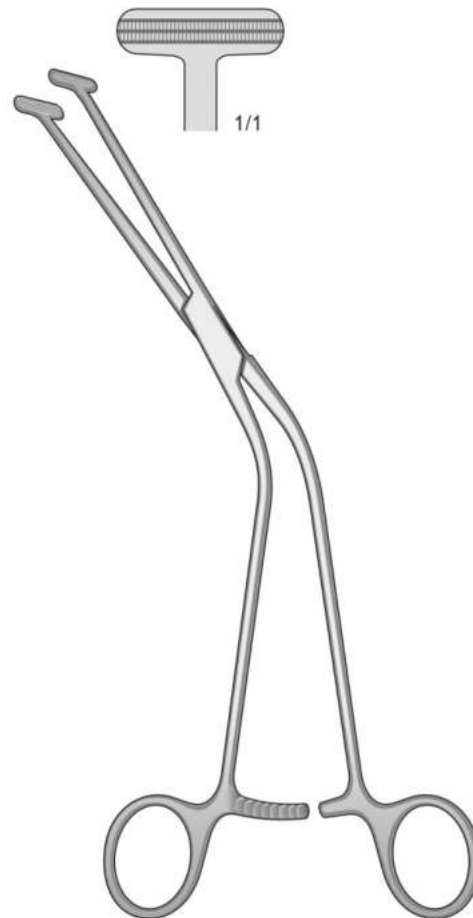
MILLIN
ST-4741
245 mm



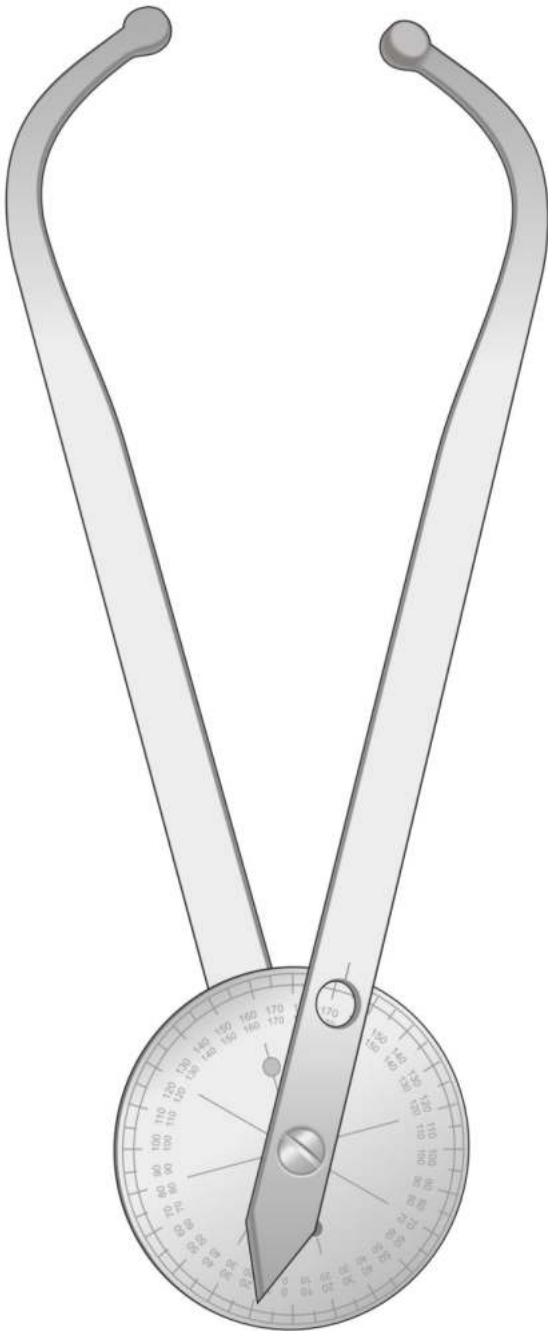
Atraumatische - Atraumatic
Atraumatiche - Atraumáticas
Atraumatiques



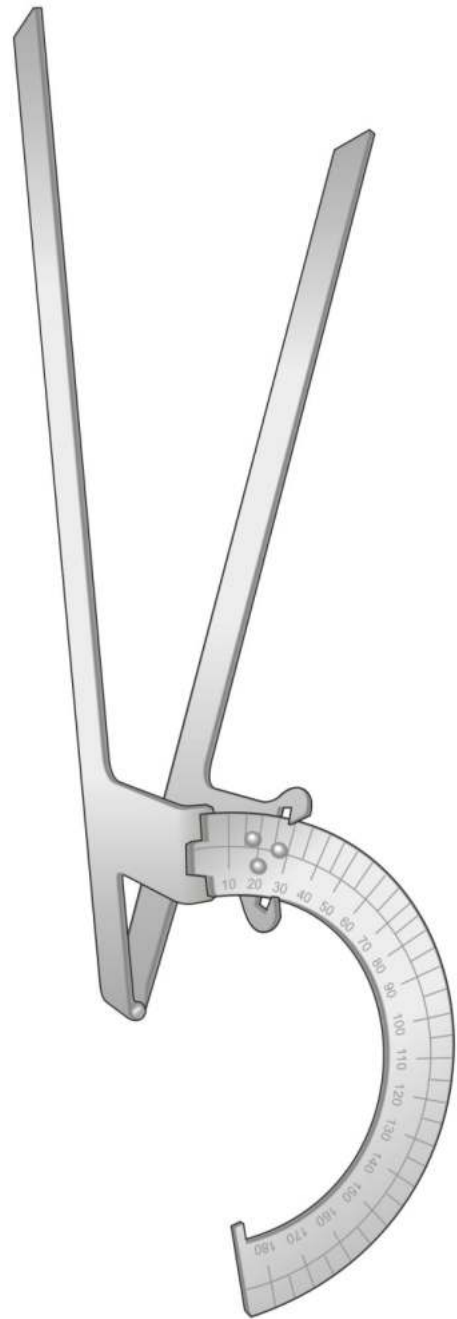
MILLIN
ST-4742
220 mm



MILLIN
ST-4743
245 mm



ST-4744
240 mm



ST-4745
235 mm



SAFE TOOL
MANUFACTURER & EXPORTER

Premium Quality Instruments of All Kind of Surgical Instruments



SAFE TOOL INSTRUMENTS

Sialkot-51310 Pakistan
Cell: +92-334-6100200
Email: info@safetool.com.pk
Web: www.safetool.com.pk

